

WHITE-RODGERS 90 SERIES 1F95CA-391

MULTI-STAGE/HEAT PUMP INSTALLATION/CONFIGURATION

INSTALLATION

DESCRIPTION

This White-Rodgers Digital Thermostat uses microcomputer technology to provide precise time, humidity, and temperature control. This thermostat offers the flexibility to design

heating and cooling programs that fit building needs. This thermostat is adaptable to most 24 volt residential forced air multi-

stage or heat pump systems with electric or fossil fuel auxiliary.

SPECIFICATIONS

1F95CA-391: 7 Day programming; residential applications.

ELECTRICAL DATA

Electrical Rating:

20 to 30 VAC, 50/60 Hz with common
0.05 to 1.5 Amps per terminal
2.5 Amps maximum total load (all terminals combined).
Hardwired only.
C terminal is required.

Standard Systems:

Multi-stage gas, oil, electric.
Single-stage or two-stage compressor heat pump.

THERMAL DATA

Setpoint Temperature Range:

45° to 99°F (7° to 37°C)

Operating Ambient Temperature:

32° to 110°F (0° to 43°C)

Operating Humidity Range:

90% non-condensing max.

Shipping Temperature Range:

-4° to 149°F (-20° to 65°C)

PRECAUTIONS

WARNING

Do not short out terminals on gas valve or primary control to test. Short or incorrect wiring will damage thermostat and could cause personal injury and/or property damage.

Do not use on circuits exceeding specified voltage. Higher voltage will damage thermostat and could cause shock or fire hazard.

Thermostat installation and all components of the system shall conform to Class II circuits per the NEC code.

CAUTION

To prevent electrical shock and/or equipment damage, disconnect electric power to system at main fuse or circuit breaker box until installation is complete.

NOTE

Read all instructions thoroughly before beginning installation.

This thermostat is intended for use with a low voltage system. Do not use on a line voltage system.

Do not exceed ratings shown in the Specifications section, above. If in doubt about the electrical ratings of your heating/cooling system, have it inspected by a qualified heating and air conditioning contractor or licensed electrician.

All wiring must conform to local and national electrical codes and ordinances.

This control is a precision instrument, and should be handled carefully. Rough handling or distorting components could cause the control to malfunction.

INSTALLATION

ATTENTION!

This product does not contain mercury. However, this product may replace a unit which contains mercury.

Do not open mercury cells. If a cell becomes damaged, do not touch any spilled mercury. Wearing non-absorbent gloves, take up the spilled mercury with sand or other absorbent material and place into a container which can be sealed. If a cell becomes damaged, the unit should be discarded.

Mercury must not be discarded in household trash. When the unit this product is replacing is to be discarded, place in a suitable container and return to White-Rodgers at 2895 Harrison Street, Batesville, AR 72501 for proper disposal.

REMOVE OLD THERMOSTAT

Shut off electricity at main fuse or circuit breaker box until installation is complete **AND** the new thermostat is configured properly.

Remove the front cover of the old thermostat. With wires still attached, remove wall plate from the wall.

Identify each wire attached to the thermostat using one of the labels enclosed with the new thermostat.

Disconnect the wires from the old thermostat one at a time. **DO NOT** let the wires fall back into the wall.

Install the new thermostat using the following procedures.

ATTACH BASE TO WALL

Remove packing material from the thermostat. Place fingers of one hand on the center top and bottom portion of the thermostat. Grasp the base in the other hand on top and bottom center and gently pull straight out. Forcing or prying on the thermostat will cause damage to the unit.

Place the base over the hole in the wall where the wires come out and mark mounting hole locations using the base as a template. Drill $\frac{3}{16}$ " pilot holes, and install screw anchors in the wall.

Run wires through hole in base and attach base to wall (see fig. 1).

Insert the wires into the terminals on the base using the appropriate wiring diagram and tighten the terminal screws.

CONFIGURING AND PROGRAMMING

The thermostat must be configured to operate properly with the system. See the CONFIGURATION section of this manual.

This thermostat can be programmed for automatic temperature control. Refer to Operating Instructions for programming.

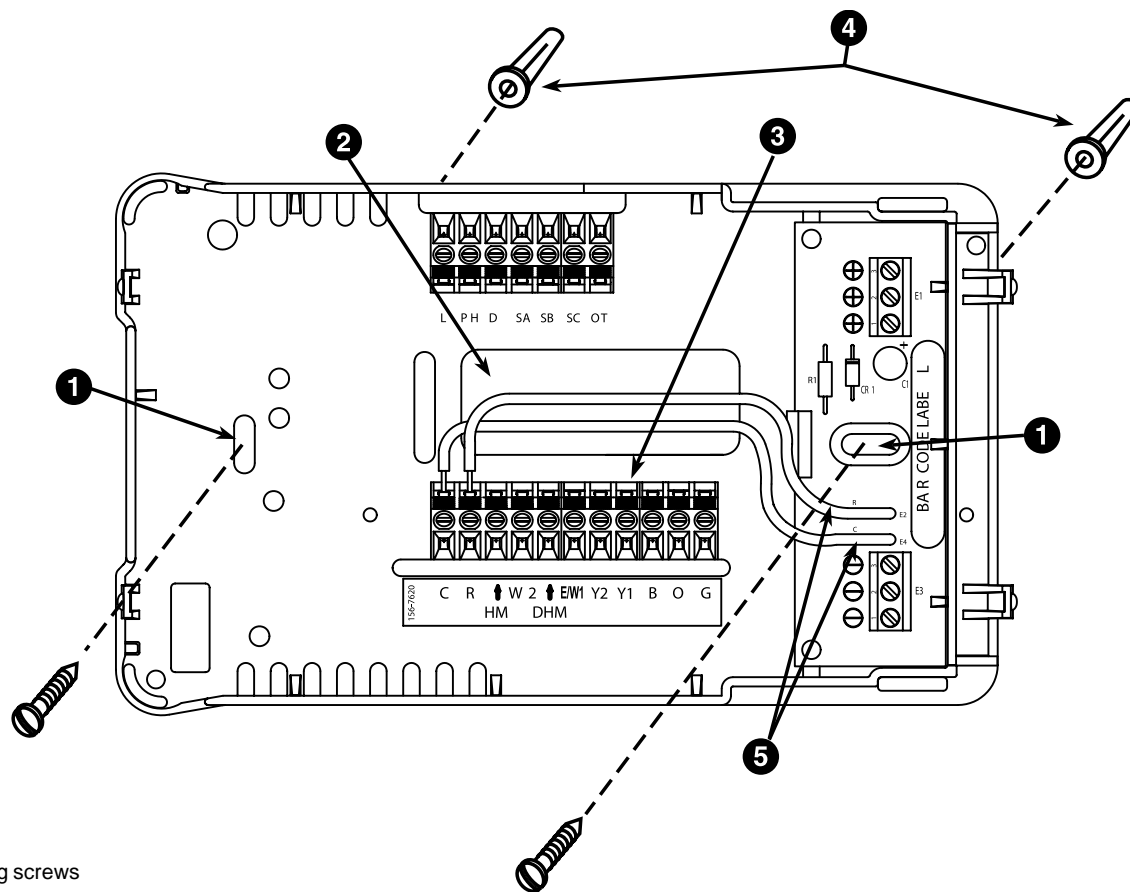

- 1 Mounting screws
- 2 Pull wires through this opening
- 3 Insert wires into terminal holes, then tighten screws
- 4 Screw anchors
- 5 Jumper connections for remote sensor power (Do not remove)

Figure 1. Thermostat base and terminals

MULTI-STAGE TERMINAL OUTPUTS

Refer to equipment manufacturers' instructions for specific system wiring information.

You can configure the thermostat for use with either multi-stage electric heat systems or multi-stage gas systems. When configured for **electric** heat, the **G** terminal (blower/fan) will be energized on a call for heat, using the installer table (pgs. 5 & 6).

This thermostat is designed to operate a single-transformer system. If you have a two-transformer system, cut and tape off one transformer. If transformer safety circuits are in only one of the systems, remove the transformer of the system with NO safety circuits. If required, replace remaining transformer with a 75VA Class II transformer. After disconnecting one transformer, the two commons must be jumpered together.

Use the terminal output information below to help you wire the thermostat properly for your multi-stage system. After wiring, see **CONFIGURATION** section for proper thermostat configuration.

THERMOSTAT TERMINALS (Upper)				
L	SA	SB	SC	OT
Malfunction Light/ Comfort Alert Interface Module	Remote Sense A	Remote Sense B	Remote Sense C	Outdoor Sensor

THERMOSTAT TERMINALS (Lower)											
SYSTEM	C	R	HM	W2	DHM	E/W1	Y2	Y1	B	O	G
Multi-Stage	24 Volt (Common)	24 Volt (Hot)	Energizes on a call for heat if Humidity setpoint is above room humidity.	Heat mode 2nd stage	E2/P switch in the P position, Energizes on a call for Dehumidification. E2/P switch in E2 position, De-energizes on a call for Dehumidification.	Heat mode 1st stage	Cool mode 2nd stage	Cool mode 1st stage	Energized in Heat and Off Mode	Energized in Cool Mode	Blower/Fan Energized on call for Cool (and Heat if configured to Electric Heat).

HEAT PUMP TERMINAL OUTPUTS

Refer to equipment manufacturers' instructions for specific system wiring information.

You can configure the thermostat for use with the following heat pump system types:

HEAT PUMP TYPE 1. Single-stage compressor system; gas or electric backup.

HEAT PUMP TYPE 2. Multi-stage or two-compressor system; gas or electric backup.

This thermostat is designed to operate a single-transformer system. If you have a two-transformer system, cut and tape off one transformer. If transformer safety circuits are in only one of the systems, remove the transformer of the system with NO safety circuits. If required, replace remaining transformer with a 75VA Class II transformer. After disconnecting one transformer, the two commons must be jumpered together.

Use the terminal output information below to help you wire the thermostat properly for your heat pump system type. After wiring, see **CONFIGURATION** section for proper thermostat configuration.

THERMOSTAT TERMINALS (Upper)				
L	SA	SB	SC	OT
Malfunction Light/ Comfort Alert Interface Module	Remote Sense A	Remote Sense B	Remote Sense C	Outdoor Sensor

THERMOSTAT TERMINALS (Lower)											
SYSTEM	C	R	HM	W2	DHM	E/W1	Y2	Y1	B	O	G
Single-stage compressor system; gas or electric backup											
Heat Pump 1	24 Volt (Common)	24 Volt (Hot)	Energizes on a call for heat if Humidity setpoint is above room humidity.	Heat mode 3rd stage, Emergency Mode 2nd stage	E2/P switch in P position, Energizes on a call for Dehumidification. E2/P switch in E2 position, De-energizes on a call for Dehumidification.	Heat mode 2nd stage, Emergency Mode 1st stage	No Output	Heat and Cool mode 1st stage (compressor 1)	Energized in Heat, Off, Emergency Mode	Energized in Cool Mode	Blower/Fan Energized on call for Heat and Cool
Multi-stage or two compressor system; gas or electric backup											
Heat Pump 2	24 Volt (Common)	24 Volt (Hot)	Energizes on a call for heat if Humidity setpoint is above room humidity.	Emergency Mode 2nd stage	E2/P switch in P position, Energizes on a call for Dehumidification. E2/P switch in E2 position, De-energizes on a call for Dehumidification.	Heat mode 3rd stage, Emergency Mode 1st stage	Heat and Cool mode 2nd stage (compressor 2)	Heat and Cool mode 1st stage (compressor 1)	Energized in Heat, Off, Emergency Mode	Energized in Cool Mode	Blower/Fan Energized on call for Heat and Cool

CONFIGURATION

SWITCHES

RESET SWITCH

See the **Troubleshooting** section at the end of this document for more information about the function of this switch.

E2/P SWITCH (DHM) TERMINAL FUNCTION

The **E2/P** switch is located on the back of the thermostat body (see fig. 2). This switch controls how the **DHM** terminal will be energized.

1. In the **P** position (up) the **DHM** terminal will be energized on a call for dehumidification.
2. In the **E2** position (down) the **DHM** terminal will always be energized except on a call for dehumidification. The switch must be in the **E2** position on some electronically controlled variable speed blower systems.

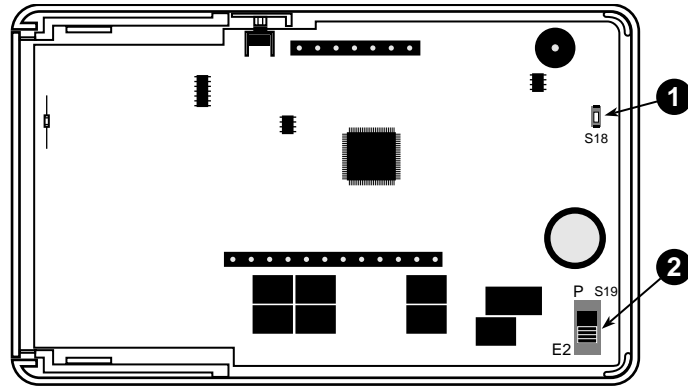

- ① Reset switch
- ② E2/P switch

Figure 2. Switch locations on back of thermostat body

DEHUMIDIFICATION WIRING WITHOUT AN ELECTRONICALLY CONTROLLED VARIABLE SPEED BLOWER SYSTEM FOR SINGLE STAGE COMPRESSOR SYSTEM ONLY

If you have a single stage compressor system see the diagram below. A relay (customer provided) should be installed as shown in Fig. 5 to switch the fan speed to the next lower speed on a call for dehumidification from the thermostat. The reduction in air flow allows the coil to remove more humidity from the air. The relay should be rated for blower motor load. Since this configuration reduces the air flow in cooling, the anti-freeze-up control (White-Rodgers CAFCC) or equivalent is recommended. The CAFCC prevents the air conditioning coil from freezing due to low air flow, dirty filters, low refrigerant pressure, etc. The CAFCC snaps onto the suction line close to the evaporator coil as possible and breaks the compressor circuit when the suction line drops below 38°F and re-make the circuit at 46°F.

NOTE: If you have a two stage compressor, the thermostat software will lengthen cycle times for the first stage of cool. The longer cycles will improve dehumidification while cooling, allowing the DHM terminal not to be used on a two stage compressor system.

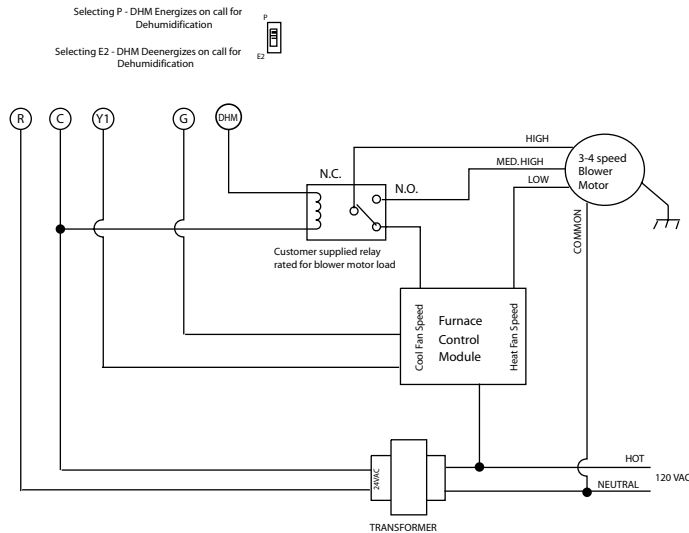

Figure 3. Typical Wiring for Dehumidifier System

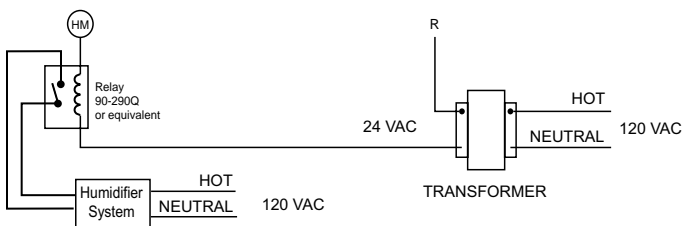

Figure 4. Typical Wiring for 120V Humidifier System

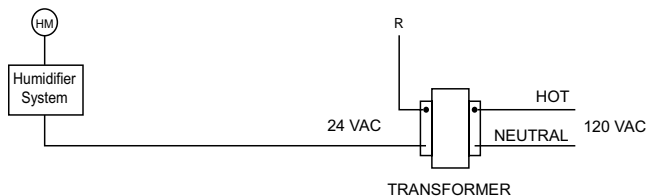

Figure 5. Typical Wiring for 24V Humidifier System

INSTALLER CONFIGURATION

BEFORE TURNING POWER ON, please read the following instructions. Before operating the system, you must configure the thermostat to operate properly with your equipment.

The thermostat, as it comes from the factory, is configured to operate a **standard multi-stage electric forced hot air system with a single stage air conditioning compressor and fan**. In this configuration, the thermostat will turn on the fan immediately on a call for heat. If you are unsure whether your system requires the thermostat to control the fan, contact your furnace/air conditioning system manufacturer or a qualified heating/air conditioning service person.

Your new thermostat has an **Installer table**, which allows you to customize the thermostat to meet your requirements.

(The thermostat also has a **User menu**, **Keypad Lockout menu** and a **Service menu**; these menus are explained further in the Operating Instructions.)

The menu settings can be changed at any time to meet system or personal requirements.

ENTERING THE CONFIGURATION MENUS

After properly wiring the thermostat, turn on power to the system. Momentarily press **PROGRAM** **RUN** to make certain the thermostat is in the run program mode, then press **TIME** **FWD** and **TIME** **BACK** at the same time to enter the User Configuration menu. When the display changes to the first item in the configuration menu, release the buttons. Then press **and hold SET** **TIME** and **SET** **DAY** for approximately 3 seconds to enter the **Installer table**. The display will change to show the first item on the Installer table (multi-stage/heat pump selection). Use the following text, along with the **Installer table**, to guide you through the selections.

Once in the table, you set each item to the proper selection using **▲** or **▼**, then press **TIME** **FWD** to change the display to the next item or **TIME** **BACK** to return to the previous item.

To exit the table at any time, press **PROGRAM** **RUN**.

MULTI-STAGE/HEAT PUMP MODE.

(Installer table step 1.) Use this item to select the system type (multi-stage or heat pump). **IF YOU HAVE A HEAT PUMP SYSTEM**, you must select **HEAT PUMP** here. This sets up proper default values for most heat pump systems. This selection also makes available some additional menu items that apply only to heat pump systems.

HEAT PUMP COMPRESSOR CONFIGURATION.

(Installer table step 2; this item is displayed only when heat pump was selected in step 1.) Use this item to select the number of heat pump compressors.

ELECTRIC HEAT FAN CONFIGURATION.

(Installer table step 3.) This item determines whether fan control will be through the thermostat or through the heating system. If you have an electric heat or other system that **REQUIRES** the thermostat to control the fan, set this item ON. This allows the thermostat to energize the fan immediately on a call for heat. If you are unsure if the system requires the thermostat to control the fan, contact the equipment manufacturer or a qualified heating and air conditioning service person. If your system controls fan operation (as with most fossil fuel systems), set this item to OFF. Note that with heat pump systems, the fan always cycles with the compressor.

SET CYCLE HEAT, COOL, AUX (ANTICIPATION).

(Installer table steps 4 through 6; step 6 is for heat pump only). These items allow the cycle times in heating, cooling and auxiliary (heat pump systems only) to be increased or decreased. The factory set values can be adjusted higher for longer cycles or lower for shorter cycles.

NOTE: Some manufacturers still instruct you to set the anticipator to the current draw of the equipment. That instruction applies only to mercury bulb or mechanical thermostats; it does not apply to this digital thermostat. As configured at the factory, this thermostat will maintain an accurate temperature. No further adjustment is necessary, although you can use these items to customize the performance of the thermostat to your requirements.

The adjustment range for **HEATING** is from 1 to 40 (9 to 40 for heat pump). The factory preset is 5 (13 for heat pump). The adjustment range for **COOLING** is from 9 to 40. The factory preset is 12 (13 for heat pump). The cooling will not go below 9 because compressors require a longer cycle. The adjustment range for **AUXILIARY** (heat pump only) is from 1 to 40. The factory preset is 6.

The chart on page 7 shows how this adjustment range affects thermostat performance.

PROGRAMMABLE COOL FAN-OFF AND FAN-ON DELAY.

(Installer table steps 7 and 8.) These items allow a selection of 0 to 127 seconds of fan-off delay after the thermostat has satisfied the call for cool, or a fan-on delay of 1 to 30 seconds on a call for cool (or heat pump compressor activation).

The fan-off delay allows the fan to continue running after the compressor has shut off. This distributes the cool air that would otherwise stay trapped in the air conditioning coils through the ducts. Ideally the timing would be set so the fan shuts off just as the cool air is exhausted. If this timing is set *too* long the fan may begin blowing warm air before it shuts off. Shortening the fan-off delay will prevent this.

A short delay to allow the A-coil to cool off (or warm up in heat pump) before the fan turns on may be preferred. This also allows the compressor and the fan to come on at slightly different times, which allows full power to the compressor on start up. Recommended setting for fan-on delay is 10 seconds or less.

PROGRAMMABLE HEAT FAN-OFF DELAY.

(Installer table step 9.) This item allows a selection of 0 to 127 seconds of fan-off delay after the thermostat has satisfied the call for heat if **ELECT HEAT FAN** (Step 3) is selected ON.

The fan-off delay allows the fan to continue running after the burner, heating element, etc. has shut off. This distributes the heat that would otherwise stay trapped in the ducts. Ideally the timing would be set so the fan shuts off just as the warm air is exhausted. If this timing is set *too* long the fan may begin blowing cool air before it shuts off. Shortening the fan-off delay will prevent this.

PUMP (FOSSIL FUEL KIT ALTERNATIVE STEPS 10 - 13).

(Installer table step 10; heat pump only) This item controls heat pump compressor operation with a fossil fuel auxiliary. This item may eliminate the need for a separate fossil fuel kit, although we recommend that you consult the heat pump system manufacturer before using this feature instead of a kit. This item will allow the thermostat to turn the heat pump compressor off if the auxiliary is on for more than one minute, to prevent compressor head pressure from getting too high. To use this feature instead of a kit, select **PUMP OFF**.

INSTALLER TABLE

NOTE: You must be in the User Configuration Menu to enter the Installer Table. Firmly press TIME **FWD and TIME **BACK** at same time and release to enter the Configuration Menu.**

Step	Press Button(s)	Displayed (Factory Default)	Press UP or DOWN to select:	COMMENTS	See Page
1	Firmly Press SET TIME and SET DAY (hold for approx. 3 seconds)	MLTI STG	HEAT PUMP	Selects type of system. Selecting HEAT PUMP makes additional items for heat pump systems available.	5
2	TIME FWD (Heat Pump ONLY)	HEAT PUMP (1)	2	1. One compressor on Y1. 2. Two compressor on Y1, Y2.	5
3	TIME FWD	ELEC HEAT FAN (ON)	OFF	Fan cycles with call for heat if ON. Fan always cycles with pump stages.	5
4	TIME FWD	SET CYCL (05) for MLTI_STG, (13) for HEAT PUMP 1, (24) for HEAT PUMP 2	1 to 40 for multi-stage 9 to 40 for heat pump	Selects HEAT anticipation adjustment.	5
5	TIME FWD	SET CYCL (24) for MLTI_STG, (13) for HEAT PUMP 1, (24) for HEAT PUMP 2	9 to 40	Selects COOL anticipation adjustment.	5
6	TIME FWD (Heat Pump ONLY)	SET CYCL AUX (08)	1 to 40	Selects AUXILIARY stage anticipation adjustment. (Heat Pump ONLY)	5
7	TIME FWD	COOL FAN DELA OFF (00)	0 to 127 seconds	Selects time delay for COOL fan OFF.	5
8	TIME FWD	FAN DELA ON (01)	1 to 30 seconds	Selects time delay for fan ON. Applies only to compressor stages for heat pump or COOL.	5
9	TIME FWD	HEAT FAN DELA OFF (00)	0 to 127 seconds	Selects time delay for fan ON only when ELECT HEAT FAN (Step 3) is ON.	5
10	TIME FWD (Heat Pump ONLY)	PUMP (ON)	OFF	Fossil Fuel Kit Alternative option. Turns compressor OFF if Auxiliary is ON for longer than one minute. (Heat Pump 1 & 2)	5
11	TIME FWD (Heat Pump ONLY)	COMP OFF DELA (60)	(0) to (99)	Available if Pump (Step 10) is OFF. Selects the delay between de-energizing fossil fuel stage and restarting Heat Pump stage.	7
12	TIME FWD (Heat Pump ONLY)	(Balance point temperature) bPT (35 F)	5 F to 50 F	Available if Pump (Step 10) is OFF and OUTDOOR Sensor ON. Selects outdoor balance point temperature for Heat Pump.	7
13	TIME FWD (Heat Pump ONLY)	(Balance point) bP (05)	(01) to (09)	Available if Pump (Step 10) is OFF and OUTDOOR Sensor OFF. The higher the number the sooner the auxiliary stage energizes. The lower the number the longer period of time before auxiliary is energized.	7
14	TIME FWD (Heat Pump ONLY)	(Programmable Blower Balance Point) bbP (OFF)	10 to 99%	Available if configured for HEAT PUMP. Adjustable from 99-10. Lowers the Blower speed if the Heat Pump duty cycle is above the selected value in percentage.	7
15	TIME FWD	COMP LOCK (OFF)	ON	Selects compressor short-cycle protection.*	7
16	TIME FWD	CA (OFF)	ON	Selects active Comfort Alert. Requires CA module and CA interface module.	7
17	TIME FWD	HEAT-OFF COOL-AUTO or HEAT-EMER-OFF-COOL-AUTO (for heat pumps)	HEAT-OFF-COOL or HEAT-EMER-OFF-COOL (for heat pumps)	Allows selection of HEAT and COOL or HEAT, COOL and AUTO with SYSTEM button. (EMER appears in sequence after HEAT if HEAT PUMP is selected).	7
	Program RUN			Returns to Normal Operation.	

* Note: COMP LOCK OFF permanently defeats compressor lockout. You must turn this selection ON if you do not have a system that already provides compressor short-cycle protection. Please see "Lockout Bypass Option" to temporarily override compressor lockout.

COMPRESSOR OFF DELAY

Installer table, step 11 is available if the fossil fuel kit alternative option (PUMP OFF) is selected.

This item allows a selection of 0 to 99 seconds, which is the time that the compressor will continue to run after the point that the auxiliary heat is energized. Running the compressor after the Auxiliary has started prevents cool air from creating drafts prior to the heat exchanger reaching normal temperatures. The factory default value of 60 seconds is typical for most systems. Consult with your equipment's manufacturer before increasing this time.

BALANCE POINT TEMPERATURE

Installer table step 12, bPT, is available only if the fossil fuel kit option is selected and the outdoor temperature sensor is used (see the user menu in the owner manual).

This item allows a selection of 5 to 50° F, which is the outdoor temperature below which the thermostat will not energize heat pump compressor stages. It will use Auxiliary heat stages (only) until the outdoor temperature raises 3° above the selected temperature and then allow compressor stages to operate. The factory default value of 35° F is typical for most systems.

BALANCE POINT

Installer table step 13, bP, is available only if the fossil fuel kit option is selected and the outdoor temperature sensor is not used. The Balance Point influences when second stage comes on. The factory default creates approximately 1° F between stages. Increasing the setting decreases the separation between stages. Decreasing the value increases stage separation. This adjustment allows a small change in the operation of your heat pump system versus your auxiliary system relative to the thermostat adjustment.

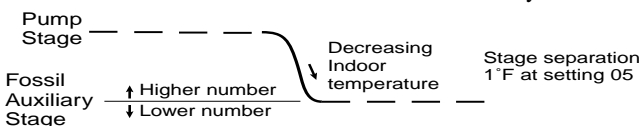

PROGRAMMABLE BLOWER BALANCE POINT

Installer table step 14, bbP, is available only when configured for Heat Pump systems, and wired as shown in Fig. 3.

If the system is running a high percentage of the time due to cold weather conditions, the output vent air temperature may be cooler than normal thus creating a drafty room condition. This feature will reduce the draft by lowering the blower speed with the DHM terminal. The lower speed will make the air temperature slightly warmer and more comfortable.

Example: If you want the blower to go to a lower speed when the system is running greater than 50% of the time, then reduce the Blower Balance Point to 50%.

To turn this feature OFF, press **▲** to 99 then press once more to display OFF.

COMPRESSOR LOCKOUT.

(Installer table step 15). This thermostat is capable of helping to protect the system against premature compressor failure by “locking out” the compressor for at least five minutes after each cycle. When the thermostat is in compressor lockout, the word COOL will flash on the display. With heat pump systems, the word HEAT will flash if the lockout occurs during a heat cycle. During this period, the compressor will not be energized.

COMFORT ALERT WITH ACTIVE PROTECTION.

(Installer table step 16). The Comfort Alert diagnostics product diagnoses system and electrical problems in the air conditioning outdoor systems with single phase Copeland Scroll compressors. Abnormal conditions are indicated by flashing ALERT codes on the yellow LED on the Comfort Alert module. The flash codes are transmitted to the thermostat by the Comfort Alert Thermostat interface module. The Comfort Alert compatible thermostat displays a CHECK SYSTEM icon that flashes at the same rate as the yellow ALERT LED on the Comfort Alert

module. Turn this feature ON to achieve active protection, enabling the thermostat to identify certain fault codes when compressor damage is possible and react to those codes by turning the compressor off.

Lockout Bypass Option

FOR QUALIFIED SERVICE TECHNICIANS' USE ONLY. HOMEOWNERS SHOULD NOT USE THIS FEATURE DUE TO POSSIBILITY OF EQUIPMENT OR PROPERTY DAMAGE, OR PERSONAL INJURY.

COMPRESSOR SHORT TERM CYCLE PROTECTION

If this thermostat has been configured to provide short-cycle protection, during the 5-minute lockout period the thermostat will lock out the compressor to allow head pressure to stabilize. To override this feature for one cycle while testing thermostat operation, press **SET** **TIME** and **SET** **DAY** buttons at the same time.

If the **system** has short-cycle protection, this item should not need to be enabled. However, **if your system does not have short-cycle protection, turn COMP LOCK ON.** This will protect the compressor from short-cycling and potential premature compressor failure.

Note that COMP LOCK OFF **permanently** disables compressor lockout. If you need to **temporarily** disable compressor lockout, please see **Lockout Bypass Option.**

DISABLING AUTOMATIC CHANGEOVER MODE.

(Installer table step 17). This thermostat, as configured at the factory, provides automatic changeover, which allows the thermostat to switch between heating and cooling to maintain temperature. In this configuration, when you press the SYSTEM button, the thermostat will go through HEAT-OFF-COOL-AUTO modes (HEAT-EMER-OFF-COOL-AUTO for heat pumps). Select HEAT(-EMER)-OFF-COOL to disable the automatic changeover feature.

(Continued)

	HEATING		COOLING	
Anticipation Value	Cycle Length	Differential Temperature	Cycle Length	Differential Temperature
1-8	Shorter	0.4-0.6°F (0.2-0.3°C)	N/A	N/A
9-20	Longer	0.6-1.0°F (0.3-0.6°C)	Shorter	0.6-1.0°F (0.3-0.6°C)
21-40	Hydronic	1.0-1.6°F (0.6-0.9°C)	Longer	1.0-1.6°F (0.6-0.9°C)

These numbers are approximate and represent operation with a typical system. Actual temperature differentials and run times may vary widely based on your building and equipment, as well as outdoor temperature conditions.

SERVICE REMINDER

The Service Button Menu allows you to view or program as many as 4 reminders that indicate when service is required.

1. Humidifiers = A programmable run time in hours to indicate on the LCD when the humidifier will need to be serviced.
2. Air Filters = A programmable run time in hours to indicate on the LCD when the filter will need to be serviced or replaced.
3. UV Lights = A programmable run time in days to indicate on the LCD when the Ultra-Violet Bulb will need to be replaced.
4. Service Timer = A programmable run time in days to indicate on the LCD when to call your service contractor.

To enter the Service Button Menu when no service reminders are on the display, press and release the **SERVICE** button. Press **TIME** **FWD** to step through the menu items. To turn a menu item **OFF** or **ON** when selected, press **▲** or **▼**. If you are setting an item to **ON**, you can then use **▲** or **▼** to select the time interval. Press **RUN** to exit the menu and return to normal operation.

When a service reminder appears on the display, press the **SERVICE** button to remove it and reset the timer to begin the count down to the next service interval.

Service Button Menu

Step	Press Button(s)	Displayed (Factory Default)	Press ▲ or ▼ to select:	COMMENTS
1	SERVICE	PAD TIME (OFF) Hrs or REM PAD TIME No. of Hrs	(ON) or (OFF)	Set Humidifier Maintenance Reminder.
2	TIME FWD (If PAD TIME is ON)	SET PAD TIME (100) Hrs	25 to 1975	Selects time intervals in increments of 25 hours. The RUN time accumulates when the HM terminal is energized.
3	TIME FWD	FLTR TIME (OFF) /Hrs or REM FLTR TIME No. of Hrs	(ON) or (OFF)	Set Air Filter Maintenance Reminder.
4	TIME FWD (If FLTR TIME is ON)	SET FLTR TIME (200) Hrs	25 to 1975	Selects time intervals in increments of 25 hours. The RUN time accumulates when the fan is operating.
5	TIME FWD	UV TIME (OFF) Days or REM UV TIME No. of Days	(ON) or (OFF)	Selects UV Light Maintenance Reminder.
6	TIME FWD (If UV TIME is ON)	SET UV TIME (375) Days	25 to 1975	Selects time intervals in increments of 25 days. The RUN time is the calendar time from when it is entered or reset.
7	TIME FWD	SERV TIME (OFF) Days or REM SERV TIME No. of Days	(ON) or (OFF)	Selects Routine Maintenance Service Call Reminder.
8	TIME FWD (If SERV TIME is ON)	SET SERV TIME (175) Days	25 to 1975	Selects time intervals in increments of 25 days. The RUN time is the calendar time from when it is entered or reset.
	PRGM RUN			Returns to Normal Operation.

CHECK THERMOSTAT OPERATION

FAN OPERATION

If your system **does not** have a **G** terminal Connection, skip to HEATING SYSTEM section below.

1. Turn power on to the system.
2. Press **PROGRAM** **RUN**.
3. Press **FAN** until **FAN ON** is displayed. The fan should begin to operate.
4. Press **FAN** until **FAN AUTO** is displayed. The fan should stop operating.

HEATING SYSTEM

1. Press **PROGRAM** **RUN**.
2. Press **SYSTEM** until **HEAT** is displayed. If the heating system has a standing pilot, ensure that it is lit.
3. Press the **▲** to adjust thermostat setting above room temperature. The heating system should begin to operate.
4. Press the **▼** to adjust thermostat setting below room temperature. The heating system should stop operating.

COOLING SYSTEM

⚠ CAUTION

To prevent compressor and/or property damage, if the outdoor temperature is below 50°F (10°C), DO NOT operate the cooling system.

1. Press the **PROGRAM** **RUN**.
2. Press **SYSTEM** until **COOL** is displayed.
3. Press **▼** to adjust thermostat setting below room temperature. The fan should come on (after the fan-on delay time, if any), followed by cold air circulation.
4. Press **▲** to adjust temperature setting above room temperature. The cooling system should stop operating, the fan should stop running (after the fan-off delay time, if any).

MULTI-STAGE/HEAT PUMP AUXILIARY OPERATION TEST

Follow these steps to energize all stages of heat or cool to permit system checks during installation.

HEAT: Press **▲** to raise temperature setting to 99°F, then hold for five seconds. The second and third stage (heat pump only) heat relays will energize immediately for test purposes. The LED indicator will glow green for first stage and yellow for second stage, and flashing yellow for third stage (heat pump only).

COOL: Press **▼** to lower temperature setting to 45°F, then hold for five seconds. The second stage cool relay will energize immediately for test purposes. The LED indicator will glow green for the first stage and yellow for second stage.

EMERGENCY (heat pump only): Press **SYSTEM** to select **EMER** mode. The LED indicator will glow red for first stage (Aux) in emergency mode.

A flashing red LED indicates a malfunction in the system.

HUMIDIFIER SYSTEM (IF INSTALLED)

1. Press **SYSTEM** until **HEAT** is shown at the top of the display.
2. Press the **HUMIDITY %** button once and release. Then press the **▲** to the maximum humidity setpoint and hold for 7 seconds until **ON** is displayed. It assures that the Humidifier will call for humidity when the thermostat calls for **HEAT** as outlined in the following steps.
3. Press **PROGRAM** **RUN**.
4. Press the **HOLD** button.
5. Press **▲** to raise the temperature setting 4°F above room temperature. The 1st stage (**LED Green**) and then 2nd stage (**LED Yellow**) will be energized. The **HM** terminal will also energize for humidification. The lowercase letter **h** will appear to the right of **HOLD**, indicating that the thermostat is calling for Humidification.
6. Press **PROGRAM** **RUN** to end the **HEAT/HUMIDIFIER** test. **NOTE:** Be sure to press the **Humidity** button and reset the humidity to the level you desire.

DEHUMIDIFICATION SYSTEM (IF INSTALLED)

1. Press **SYSTEM** until **COOL** is shown at the top of the display.
2. Press the **HUMIDITY %** button once and release. Then press **▼** to the minimum humidity setpoint and hold for 7 seconds until **ON** is displayed. It assures that the Dehumidifier will call for dehumidification when the thermostat calls for **COOL** as outlined in the following steps.
3. Press **PROGRAM** **RUN**.
4. Press the **HOLD** button.
5. Press **▼** to lower the temperature setting 1°F below room temperature. The 1st stage of the cooling system should begin to operate and the **LED** indicator will glow Green. The lowercase letter **d** will appear to the right of **HOLD**, indicating that the thermostat is calling for Dehumidification.
6. Press the temperature **▼** to lower your setpoint 4°F below room temperature, the **DHM** terminal will energize causing the **FAN** to go to high speed.
7. Press the **HUMIDITY %** button and set your desired dehumidification setpoint in **% RH** using the **▲** and **▼**.
8. Press **PROGRAM** **RUN** to accept the change.





TROUBLESHOOTING

RESET BUTTON

If the thermostat does not respond when keys are pressed, or the thermostat is not operating properly, you may use the reset button located on the back of the thermostat body (see fig. 2). Thermostat programming and configuration will **not** be affected by pressing the reset button. However, the clock will need to be reset.

RESETTING THERMOSTAT CONFIGURATION AND PROGRAMMING

The thermostat can be reset back to default programs and configuration. Removing power from the thermostat **will not** reset it, because the default settings are maintained in permanent memory. **Before resetting the thermostat**, you may want to make note of the previously selected configuration and programming. **You must reconfigure and reprogram the thermostat after resetting it using this method.**

To reset the thermostat, press and release **PROGRAM** , then press the **FAN** , **TIME**  and  buttons at the same time. This will reset the thermostat to factory default programs and configuration. The display will momentarily go blank, then all segments on the display will momentarily be shown. The thermostat will then go into the **HOLD** mode and will maintain factory preset temperatures.



TROUBLESHOOTING

Symptom	Possible Cause	Corrective Action
Thermostat Does Not Follow Program	<ol style="list-style-type: none"> 1. AM or PM set incorrectly in program. 2. AM or PM set incorrectly on clock. 3. Voltage spike or static discharge. 	Check current clock and program settings including AM or PM designations for each time period. If a voltage spike or a static discharge occurs use the reset operation listed above.
Blank Display and/or Keypad Not Responding	<ol style="list-style-type: none"> 1. Voltage spike or static discharge. 2. Battery change required. 	Replace batteries and check heat/cool system for proper operation. If a voltage spike occurs use the Reset Operation listed above.
No Heat/No Cool/No Fan (Common Problems)	<ol style="list-style-type: none"> 1. Blown fuse or tripped circuit breaker. 2. Furnace power switch to OFF. 3. Furnace blower compartment door or panel loose or not properly installed. 	<p>Replace fuse or reset breaker. Turn switch to ON. Replace door panel in proper position to engage safety interlock or door switch.</p>
No Heat	<ol style="list-style-type: none"> 1. Pilot light not lit. 2. SYSTEM button not pressed to display HEAT. 3. Loose connection to thermostat or system. 4. Furnace Lock-Out Condition. Heat may also be intermittent. 5. Heating system requires service or thermostat requires replacement. 	<p>Re-light pilot. Set SYSTEM button until HEAT is displayed and raise temperature above room temperature. Verify thermostat and system wires are securely attached. Many furnaces have safety devices that shut down when a lock-out condition occurs. If the heat works intermittently contact the furnace manufacturer or local service person for assistance. Diagonistic: Set SYSTEM button until HEAT is displayed and raise setpoint above room temperature. Within a few seconds the thermostat should make a soft click sound. This sound usually indicates the thermostat is operating properly. If the thermostat does not click, try the reset operation listed on the previous page. If the thermostat does not click after being reset contact your heating and cooling service person or place of purchase for replacement. If the thermostat clicks, contact the furnace manufacturer or a service person to verify the heating system is operating correctly.</p>

TROUBLESHOOTING

Symptom	Possible Cause	Corrective Action
No Cool	<ol style="list-style-type: none"> 1. SYSTEM button not pressed to display COOL. 2. Loose connection to thermostat or system. 3. Cooling system requires service or thermostat requires replacement. 	<p>Set SYSTEM button until COOL is displayed and raise temperature below room temperature.</p> <p>Verify thermostat and system wires are securely attached.</p> <p>Same procedure as diagnostic for No Heat condition except press the SYSTEM button until COOL is displayed and lower the setpoint below room temperature. There may be up to a five minute delay before the thermostat clicks in Cooling.</p>
Heat, Cool or Fan Runs Constantly.	<ol style="list-style-type: none"> 1. Possible short in wiring. 2. Possible short in thermostat. 3. Possible short in Heat/Cool/Fan system. 4. FAN button pressed to display FAN ON. 	<p>Check each wire connection to verify they are not shorted or touching together. No bare wire should out from under terminal screws. Try resetting the thermostat as described on the previous page. If the condition persists the manufacturer of your system or service person can instruct you on how to test the Heat/Cool system for correct operation. If the system operates correctly, replace the thermostat.</p>
Furnace Cycles Too Fast or Too Slow (narrow or wide temperature swing)	<ol style="list-style-type: none"> 1. The location of the thermostat and/or the size of the Heating System equipment may be influencing the cycle rate. 	<p>Digital thermostats normally provide precise temperature control and may cycle faster than some older mechanical models. A faster cycle rate means the unit turns on on off more frequently but runs for a shorter time so there is no increase in energy use. If you would like to increase the cycle time, refer to page 6 under Installer Table for settings. If an acceptable cycle rate is not achieved by the adjustment in the Installer Table then you may want to contact a local heating and air conditioning service person for further suggestions.</p>
Cooling Cycles Too Fast or Too Slow (narrow or wide temperature swing)	<ol style="list-style-type: none"> 1. The location of the thermostat and/or the size of the Cooling System can influence the rate. 	<p>The cycle rate for cooling is fixed and can not be adjusted. Contact a local service person for suggestions.</p>
Thermostat Setting and Thermostat Thermometer Disagree	<ol style="list-style-type: none"> 1. Thermostat thermometer setting requires adjustment. 	<p>The thermometer can be adjusted +/- 5 degrees. See Temperature Display Adjustment in the Operating Manual under Configuration.</p>
Thermostat Display Shows CHCK PAD, CHNG FLTR, CALL SERV UV, CALL SERV	<ol style="list-style-type: none"> 1. Thermostat service indicators. 	<p>These indicators can be reset or modified in the service button menu (see pg. 8).</p>

FAQs

Why does the system run with the setpoint and room temperature the same?	<p>In cooling, as the room temperature falls you will eventually reach the setpoint temperature. The system will continue to run until it reaches the low side of the temperature setting. As an example: If set to 78 degrees with the room temperature falling the thermostat will continue to call for cool as the temperature decreases in the following manner. 78.9, 78.8, 78.7, 78.6, 78.5, 78.4, 78.3, 78.2, at approximately 78.2 the thermostat will quit calling for cool. This is why it is not unusual for the room temperature and set temperature to read the same but the system continues to run. The amount of time it takes for the system to shut off is dependent on system sizing, thermostat location, etc. Note: The thermostat display only displays whole numbers. Internally the thermostat calculates decimals.</p> <p>In heating as the room temperature increases the system will continue to run until the thermostat reaches the high side of the temperature setpoint.</p>
Why is the temperature change display so slow?	<p>Digitals are engineered to a specific response rate. Compared to a thermometer it will seem slow. When left to acclimate and control temperature it will provide precise temperature control on a properly sized system.</p>
How do I temporarily Override the program and Hold Til Timing?	<p>Any time your program is running and you would like to override it for a specific amount of time, press  or  until the temperature you want is displayed. The display will indicate HOLD, and the number of hours remaining in the hold period will be indicated with the word HRS. To adjust the length of time for the override, press TIME FWD or TIME BACK. The time you select will become the new number of hours for the Hold Til timing. Once your time is selected, let the thermostat revert back to normal operation on its own to accept the change.</p>
What is the thermostat Click Test?	<p>Many furnaces have safety devices that shut the system down when a lock-out condition occurs in the furnace. If the thermostat is turned off or the call for heat is cancelled (by lowering and then raising the set temperature) the furnace may start operating again. A diagnostic to see if the thermostat is operating when the room temperature is below the thermostat setting (in heat) is to lower the setting below the room temp. Within about 3 seconds the thermostat should make a soft click sound. This sound is the thermostat turning off the call for heat and usually indicates the thermostat is operating properly. If the thermostat does not click you would be suspicious of the thermostat and try resetting it by following it's reset operation. If the thermostat does not click after being reset contact your heating and cooling service person or place of purchase for a replacement. If the thermostat clicks and the heat works intermittently contact the furnace manufacturer or local service person. They will want to observe the condition when it is not working.</p> <p>You can raise and lower the temperature a few degrees above and below the room temperature and each time expect to hear the thermostat click on and off within a few seconds. If it clicks, it is operating properly.</p>