



TP-S-955WH

VIVE Comfort

1111 S. Glenstone Ave., Suite 2-100
Springfield, MO 65804

Toll-Free: 1-800-776-1635 **Web:** www.vivecomfort.com

Hours of Operation: M-F 9AM - 6PM Eastern

Thermostat Applications Guide

Description	
Gas or Oil Heat	Yes
Electric Furnace	Yes
Heat Pump (No Aux. or Emergency Heat)	Yes
Heat Pump (with Aux. or Emergency Heat)	Yes
Multi-stage Systems	Yes
Heat Only Systems	Yes
Cool Only Systems	Yes
Dual Fuel Systems	Yes
Millivolt	No
Humidity	Yes

Table of Contents

Page

Thermostat Quick Reference	2
Installation Tips	3-5
Wireless Communication Tips	6
Reestablishing Communication	7
Subbase Installation	8-9
Mounting & Battery Installation	10
Wiring	11-12
Technician Setup Menu	13-18
Setting The Humidity	19
Programming The Thermostat	20-23
Specifications	24

Power Type

Battery Power*

Hardwire (Common Wire)

Hardwire (Common Wire) with Battery Backup

* If using remote sensors the thermostat must be hardwired.

A trained, experienced technician must install this product.

Carefully read these instructions. You could damage this product or cause a hazardous condition if you fail to follow these instructions.

Una versión en español de este manual se puede descargar en la página web de la compañía.

Getting to know your thermostat



Important:

The low battery indicator is displayed when the AA battery power is low. If the user fails to replace the battery within 21 days, the thermostat display will only show the low battery indicator as a final warning before the thermostat becomes inoperable. The batteries are located on the back of the thermostat.

1 LCD

Days of the week and time. Flashes ambient humidity level. May also flash outside temperature when used with ROS-250W. **OUTDOOR** will show.

REMOTE indicates a remote has control of the system.

HOLD is displayed when thermostat program is permanently overridden.

Displays the user selectable setpoint temperature.

2 *Glow in the Dark Light Button

3 Fan Button

4 System Button

5 Temperature Setpoint Buttons

6 Menu Button

7 Humidity Button

* NOTE ABOUT THE LIGHT BUTTON:

This button is used to light up the display, but it is also used to set up communication with the base module. **DO NOT** hold the light button down for more than 10 seconds, unless you are performing the initial communication setup steps.

Programmable Time Period Icons:

This thermostat can have 2 or 4 programmable time periods per day. Icons are displayed for 4 time periods. Occupied and unoccupied will display in the text field for 2 time periods.

Temperature: Indicates the current system temperature.

Humidity: Shows the humidity target setpoint settings and keys.

Clean Display: Pressing **CLEAN DISPLAY** will allow 30 seconds to clean the display. The keys will be inoperable during this time. **CLEAN** will appear if your contractor has programmed a filter change reminder. Press **CLEAN** when filter has been replaced to reset the filter change reminder timer.

Program Menu Options: Shows different options during programming.

Low Battery Indicator: Replace batteries when this indicator is shown.

System operation indicators:

COOL HEAT FAN

The **COOL, HEAT** or **FAN** icon will display when the **COOL, HEAT** or **FAN** is on.

NOTE: The compressor delay feature is active if these icons are flashing. The compressor will not turn on until the 5 minute delay has elapsed.

System Information:

Shows which zone or zones are controlling your system. Shown only when one or more indoor sensors **RIS-251W** are connected.

Wireless Icon

Removing the private label badge

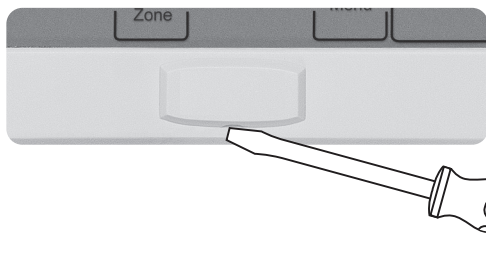

Use the bevel on lower ridge

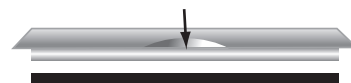

Magnet in door

Gently slide a screwdriver into the bottom edge of the badge. Gently turn the screwdriver counter clockwise. The badge is held on by a magnet. The badge should pry off easily. **Do not use force.**

About the Badge

All our thermostats use the same universal magnetic badge. Visit our website to learn more about our dealer imprinting programs.

Wall locations

The thermostat should be installed approximately 4 to 5 feet above the floor. Select an area with average temperature and good air circulation.

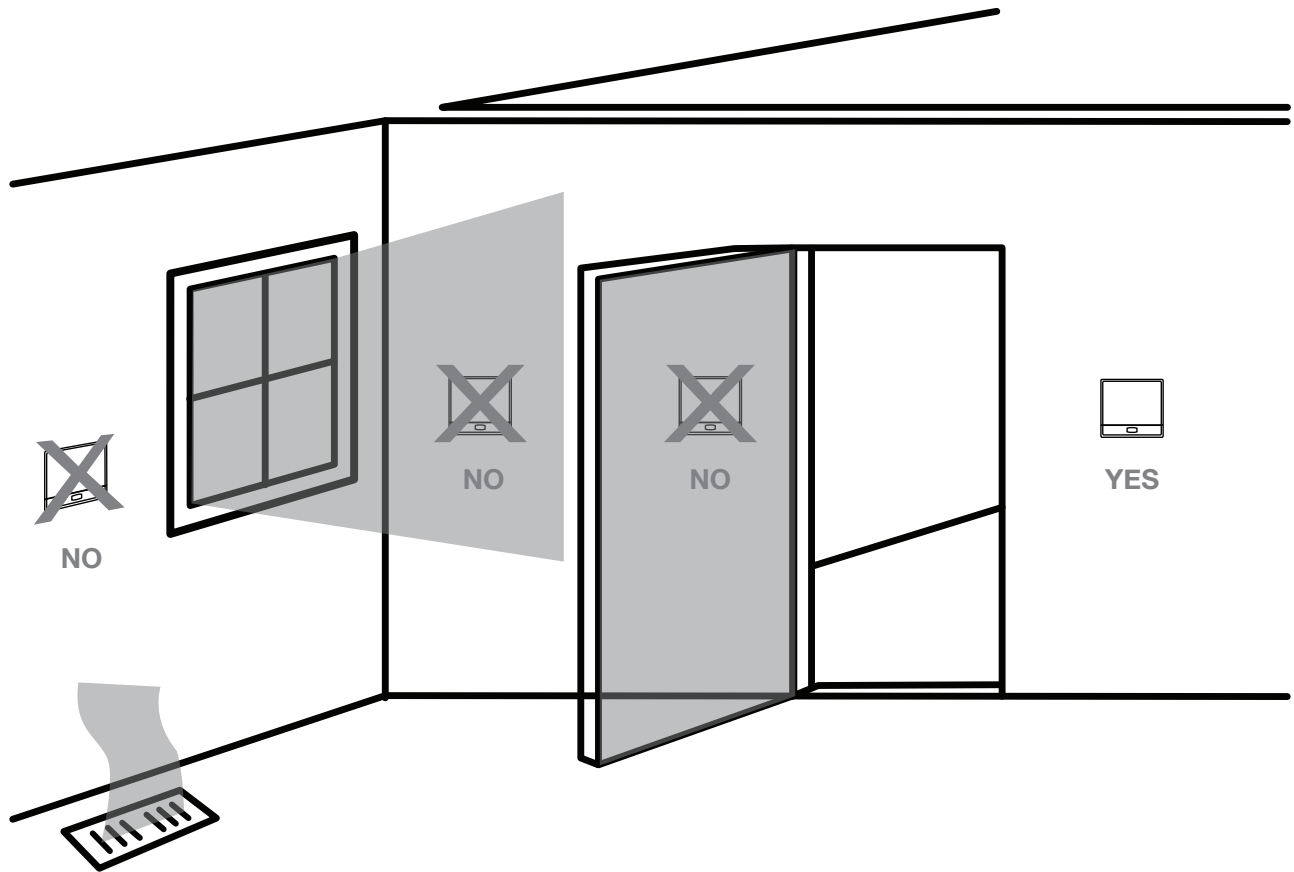

Do not install thermostat in locations:

- Close to hot or cold air ducts
- That are in direct sunlight
- With an outside wall behind the thermostat
- In areas that do not require conditioning
- Where there are dead spots or drafts (in corners or behind doors)
- Where there might be concealed chimneys or pipes
- Where appliances could radiate heat

Installation Tip

Pick an installation location that is easy for the user to access. The temperature of the location should be representative of the building.

Base Module - Attic Installation

BASEMENT INSTALLATION
ON THE NEXT PAGE



When performing an attic installation, instead of placing the base module in the attic, locate the closet nearest to the air conditioning unit. Then mount the base module high on the wall inside the closet or on the ceiling of the closet. This location will insure the base module is below the 150°F maximum ambient temperature specification.

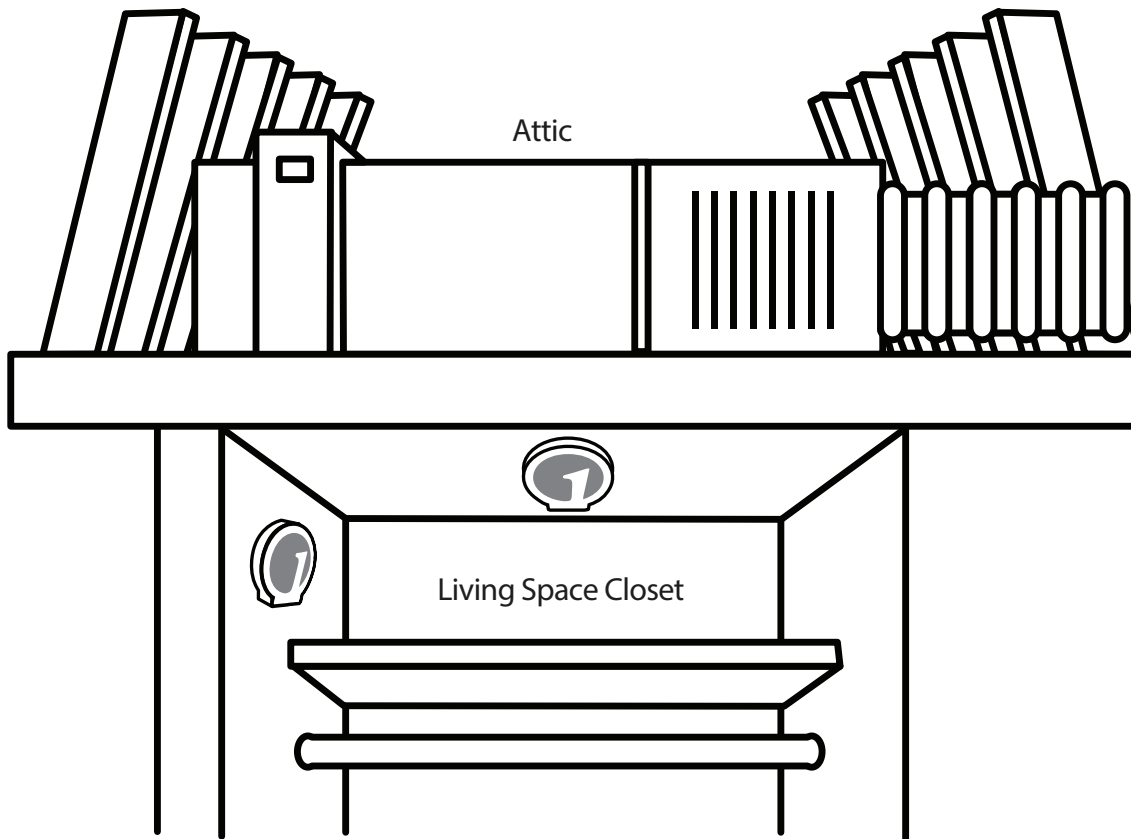

Installation Tip

Do not install the base module in locations:

- That are behind a chimney
- Where temperature could exceed 150°F
- Where rain or snow or extreme hot or cold is possible

NOTE: The base module is NOT weatherproof.

Base Module - Basement Installation

Wireless Range

Range between the S-955WH and the base module is up to 100 feet with no obstructions and up to 50 feet in standard residential construction. To extend the range try placing the base unit higher if in a basement or further away from large metal objects.

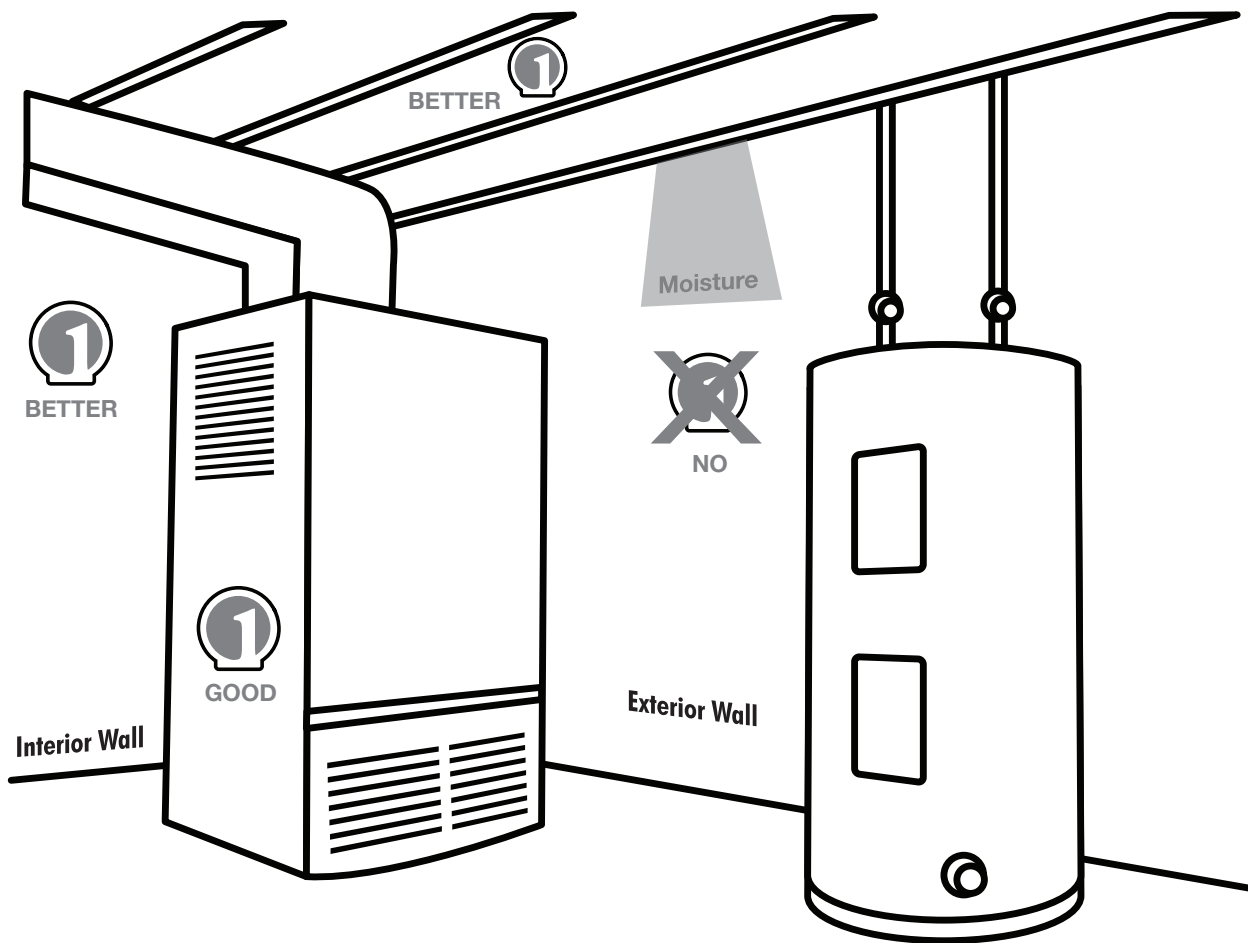

Installation Tip

Do not install the base module in locations:

- That are behind a chimney
- Where temperature could exceed 150°F
- Where rain or snow or extreme hot or cold is possible

NOTE: The base module is NOT weatherproof.

WIRELESS COMMUNICATION TIPS



WIRELESS REMOTE
SIGNAL CONNECTION



CHECK

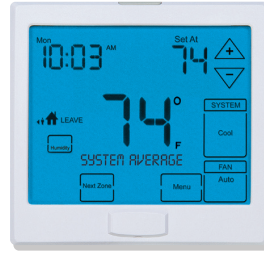

MASTER THERMOSTAT
SIGNAL CONNECTION



CHECK



BASE MODULE
SIGNAL CONNECTION

Follow these steps for a Simple Wireless Communication Setup.



1 Locate all components in area near equipment.

2 Wire Base Module with 8ft pigtail and temporarily mount.

If you are not able to establish communication, this will allow you to relocate the Module to an area with less obstruction, without having to rewire.

3 Install batteries in all devices you wish to use.

S-955WH, RIS-251W, ROS-250W

4

- A) Press menu button on thermostat
- B) Press & hold tech set up button
- C) Configure set up for your application
- D) Establish communication between devices

5 Install S-955WH in final location.

NOTE: You must hardwire the thermostat when using remotes.

6 Turn On fan from Thermostat to ensure communication.
Once communication is established, permanently mount module.

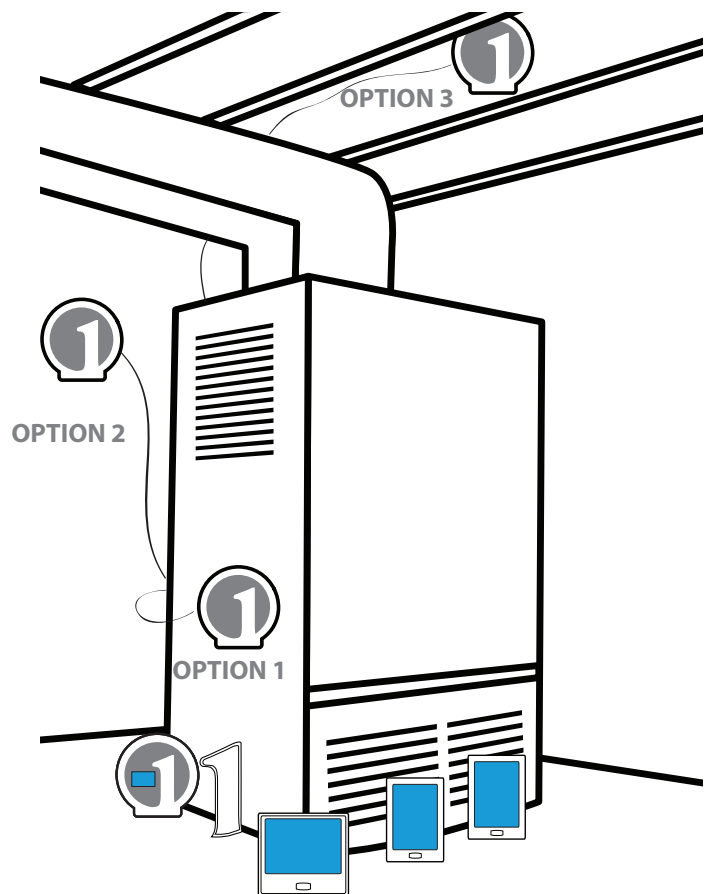

Troubleshooting

If there is no communication between the thermostat and Base Module devices that are less than 50ft apart, utilize an 8ft pigtail to relocate and reduce interference. If there is no communication and devices are over 50ft apart, add a TP-W150W - Wireless Repeater. (See image to the right)



Establishing Communication between S-955WH Master Thermostat and the Base Module

The thermostat and base module come factory linked out of the box. If however, communication is lost, follow this easy-**Two Step** process to re-establish the communication link.

1. Press and hold the **base module** button for 3 seconds. The **Blue LED** will flash when ready to receive initial signal from **S-955WH**. (Base module must be powered by 24V. **Blue LED** will be continuously on when 24V power is present.)
2. Hold the **Light key** (shown here) of the **S-955WH** for 10 seconds, the **Blue LED** on the base module will stop flashing after communication has been established between **base module** and the **S-955WH**.

Note:

The **Blue LED** on the **base module** will be on when power is present. The **Blue LED** will flash 3 times every time it receives a signal from **S-955WH**. When a relay is on the corresponding LED relay indicator will be on.

Note:

If the base module does not receive a signal from the **S-955WH** for 15 minutes it will turn off all relays until communication is reestablished. The **Blue LED** on the base module will also turn off to show communication has been lost.

Note:

If communication has been lost for 1 hour and if freeze protection is enabled, heat and emergency heat relays will be turned on. The heat and emergency heat relays will turn on for 10 minutes every hour if there has been a call for heat in the last 24 hours.

Step 1.

LED Relay Indicators Blue LED

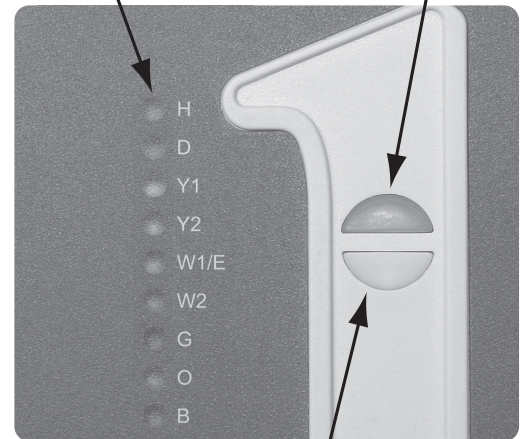

Base Module Button

Step 2.

Light key



Important:

DO NOT hold the light button on the **S-955WH** for more than 10 seconds after Step 2 above has been completed. Holding the light button down will break the communication link and the base module button will need to be pressed again to reestablish communication.

MASTER THERMOSTAT SUBBASE INSTALLATION



Caution:

Electrical Hazard

Failure to disconnect the power before beginning to install this product can cause electrical shock or equipment damage.



Mercury Notice:

All of our products are mercury free. However, if the product you are replacing contains mercury, dispose of it properly. Your local waste management authority can give you instructions on recycling and proper disposal.

For vertical mount put one screw top and one screw bottom.

For horizontal mount put one screw left and one screw right.

NOTE:

To insure a solid fit between the thermostat and the subbase, mount the subbase on a flat wall with the drywall anchors flush to the wall. Using the screws and drywall anchors that were provided with the thermostat.

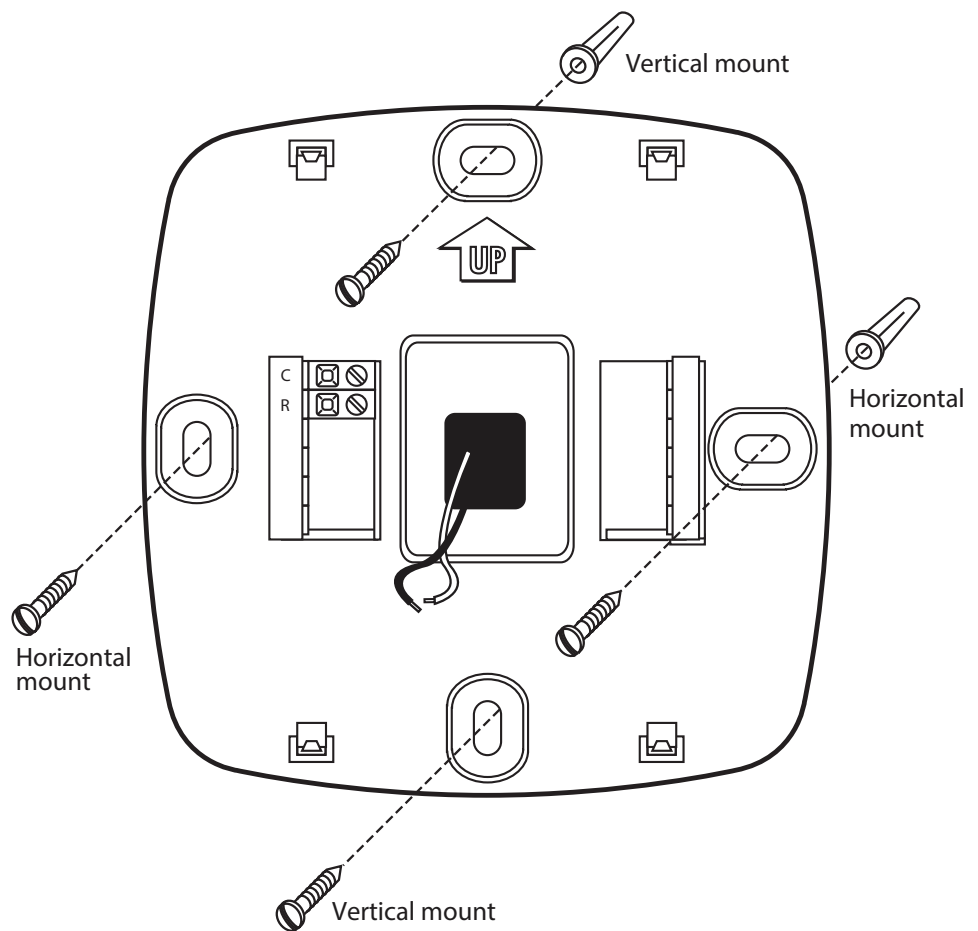

Note:

The S-955WH can be battery powered only if used as a stand-alone thermostat solution. The S-955WH must be hardwired (C and R terminals connected to 24V power) if remote sensors (RIS-251W or ROS-250W) are used.

INSTALLATION MANUAL

BASE MODULE SUBBASE INSTALLATION

Wiring Note:

Wire the base module's subbase the same way you would wire a hardwired thermostat subbase.

Note:

To connect the base module to master thermostat, refer to the directions on page 9 of this manual.

For vertical mount put one screw top and one screw bottom.

For horizontal mount put one screw left and one screw right.

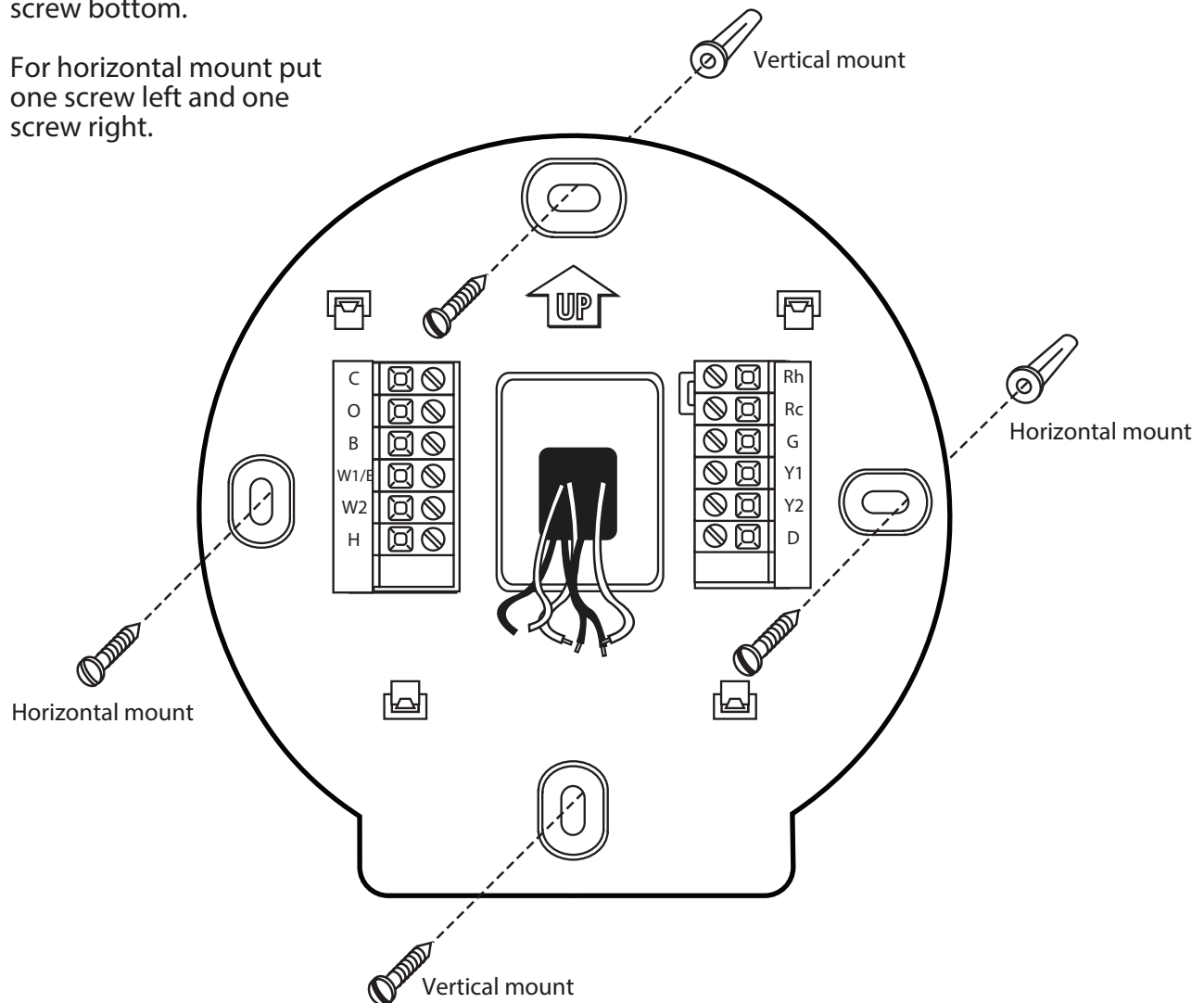

Note:

The base module must be hardwired (C and R terminals connected to 24V power).

INSTALLATION MANUAL

MOUNT THERMOSTAT & BATTERY INSTALLATION

Mount Thermostat and Base Module

Align the 4 tabs on the subbase with corresponding slots on the back of the thermostat or base module. Then push gently until the thermostat or base module snaps in place.

Note: To insure a solid fit between the thermostat and the subbase:

1. Mount subbase to a flat wall
2. Use screws provided
3. Drywall anchors should be flush with the wall
4. Wires should be pushed into the wall

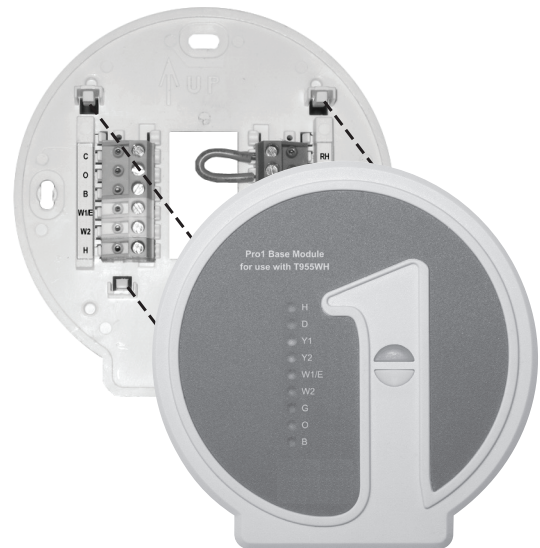

Note:

The base module can be wired from the back or the bottom.

Battery Installation

Battery installation is optional if there are no remotes connected to the Master Thermostat (**C** terminal connected). If you connect an outdoor remote and/or indoor remote sensors it is required the thermostat be hardwired.

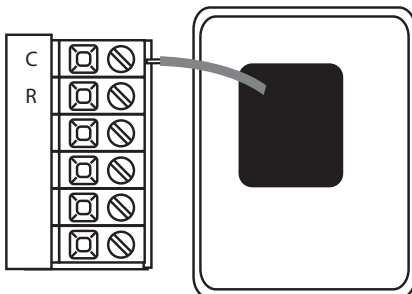

On the back of the thermostat insert 2 AA Alkaline batteries (included).

Wiring

1. If you are replacing a thermostat, make note of the terminal connections on the thermostat that is being replaced. In some cases the wiring connections will not be color coded. For example, the green wire may not be connected to the **G** terminal.
2. Loosen the terminal block screws. Insert wires then retighten terminal block screws.



Warning:

All components of the control system and the thermostat installation must conform to Class II circuits per the NEC Code.

Wire specifications

Use shielded or non-shielded 18 - 22 gauge thermostat wire.

Note:

In many heat pump systems with no emergency heat relay a jumper can be installed between E and W2.

Terminal Designations on Base Module

This thermostat is shipped from the factory to operate a conventional heating and cooling system. This thermostat will also operate a heat pump system. See the "heat pump" configuration step on page 12 of this manual to configure the thermostat for heat pump applications.

Terminal	2 Heat 2 Cool Conventional System	2 Heat 2 Cool Heat Pump System	3 Heat 2 Cool Heat Pump System
RC	Transformer power (cooling)	Transformer power (cooling)	Transformer power (cooling)
RH	Transformer power (heating)	Transformer power (heating)	Transformer power (heating)
C	Transformer common	Transformer common	Transformer common
B	Energized in heating	Heat pump changeover valve energized in heating	Heat pump changeover valve energized in heating
O	Energized in cooling	Heat pump changeover valve energized in cooling	Heat pump changeover valve energized in cooling
G	Fan relay	Fan relay	Fan relay
W/E	First stage of heat	Emergency heat relay	Emergency heat relay
Y	First stage of cool	First stage of heat & cool	First stage of heat & cool
Y2	Second stage of cool	Second stage of cool	Second stage of cool & second stage of heat
W2	Second stage of heat	Auxiliary heat relay, second stage of heat	Auxiliary heat relay, third stage of heat
H	Humidify	Humidify	Humidify
D	Dehumidify	Dehumidify	Dehumidify

Terminal Designations on S-955WH Master Thermostat

Terminal	2 Heat 2 Cool Conventional System	2 Heat 2 Cool Heat Pump System	3 Heat 2 Cool Heat Pump System
R	24 VAC Transformer power	24 VAC Transformer power	24 VAC Transformer power
C	Transformer common	Transformer common	Transformer common

Powering the S-955WH Master Thermostat

If you add remote sensors (ROS-250W or RIS-251W) to this wireless system you must hardwire the S-955WH master thermostat.

- ▲ 1 Power supply.
- ▲ 2 Factory-installed jumper. Remove only when installing on 2-transformer systems.
- ▲ 3 Use either O or B terminals for changeover valve.
- ▲ 4 If DEHUM Relay requires a normally-energized input, set Dehumidity Relay to NC in Technician Setup.

Typical 2H/2C system: 1 transformer

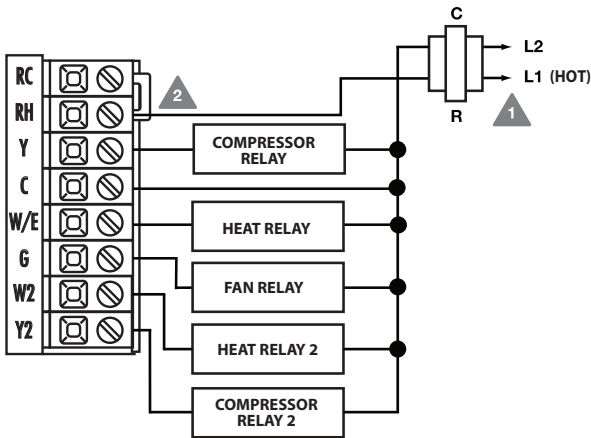

Typical 2H/2C system: 2 transformer

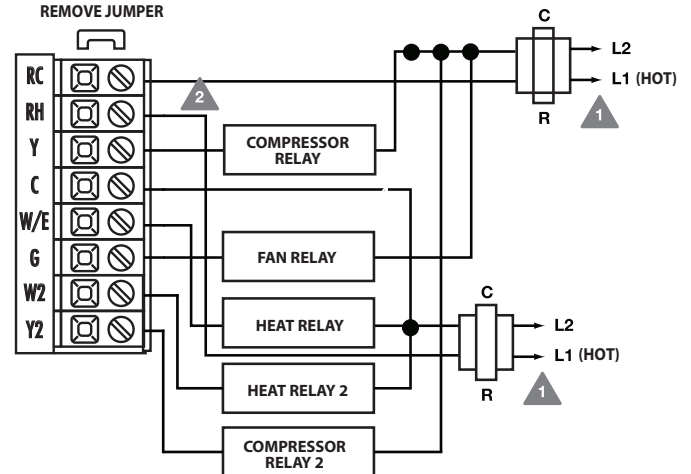

Typical 3H/2C heat pump system

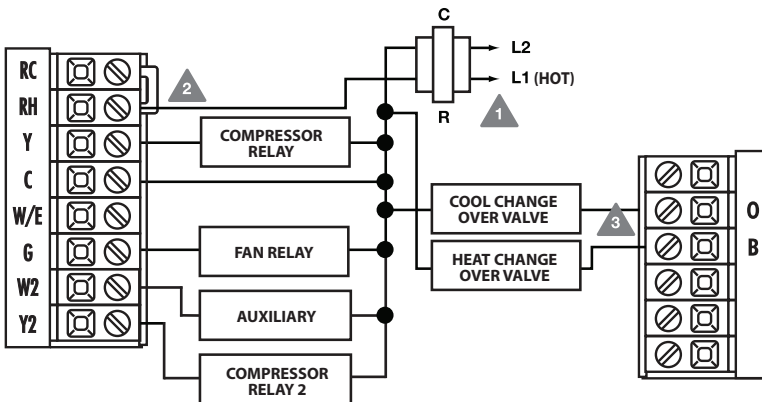

Typical 2H/2C system with 24VAC Humidifier

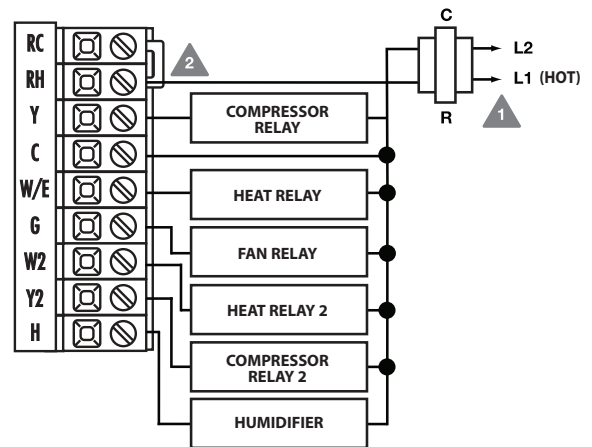

Typical 2H/2C system with Dehum Terminal

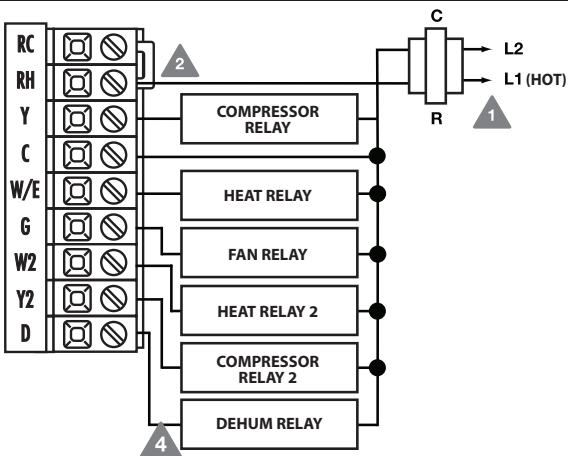

Typical 2H/2C system with Dry Contact Humidifier

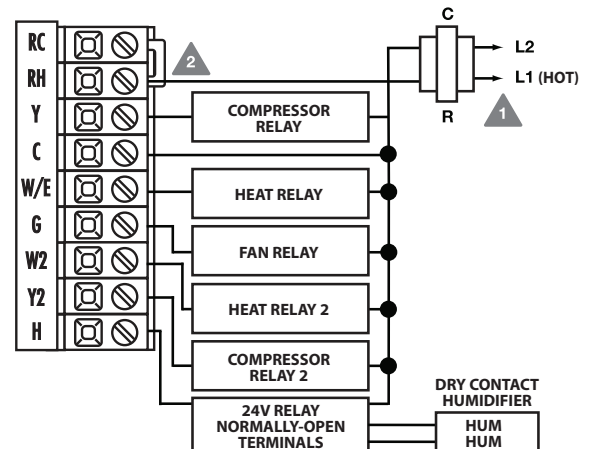



NOTE: In many systems with no emergency heat relay a jumper can be installed between E and W2.









Technician Setup Menu





This thermostat has a technician setup menu for easy installer configuration. To set up the thermostat for your particular application:

1. Press **MENU** button
2. Press and hold **TECHNICIAN SETUP** button for 3 seconds. This 3 second delay is designed so that homeowners do not accidentally access the installer settings.

3. Configure the installer options as desired using the table below.

Use the  or  keys to change settings and the **NEXT STEP** or **PREV STEP** key to move from one option to another. **Note:** Only press **DONE** key when you want to exit the Technician Setup options.







Tech Setup Steps						
Filter Change Reminder	Room Temperature Calibration	Minimum Compressor On Time	Compressor Short Cycle Delay	Cooling Swing	Heating Swing	Keypad Lockout
This feature will flash FILT in the display after the elapsed run time to remind the user to change the filter. A setting of OFF will disable this feature.	This feature allows the installer to change the calibration of the room temperature display. For example, if the thermostat reads 70° and you would like it to read 72° then select +2.	This feature allows the installer to select the minimum run time for the compressor. For example, a setting of 4 will force the compressor to run for at least 4 minutes every time the compressor turns on, regardless of the room temperature.	The compressor short cycle delay protects the compressor from "short cycling". This feature will not allow the compressor to be turned on for 5 minutes after it was last turned off.	The swing setting, often called "cycle rate", "differential" or "anticipation" is adjustable. A smaller swing setting will cause more frequent cycles and a larger swing setting will cause fewer cycles.	The swing setting, often called "cycle rate", "differential" or "anticipation" is adjustable. A smaller swing setting will cause more frequent cycles and a larger swing setting will cause fewer cycles.	Keypad lockout allows you to configure the thermostat so that none or some of the keys do not function.
LCD Will Show						
						
Adjustment Options						
You can adjust the filter change reminder from OFF to 2000 hours of runtime in 50 hour increments.	You can adjust the room temperature display to ready -4°F to +4°F above or below the factory calibrated reading.	You can select the minimum compressor run time from "off", "3", "4", or "5" minutes. If 3, 4, or 5 is selected, the compressor will run for at least the selected time before turning off.	Selecting ON will not allow the compressor to be turned on for 5 minutes after the last time the compressor was on. Select OFF to remove this delay.	The cooling swing setting is adjustable from ±0.2°F to ±2°F. For Example: A swing setting of 0.5°F will turn the cooling on at approximately 0.5°F above the setpoint and turn the cooling off at approximately 0.5°F below the setpoint.	The heating swing setting is adjustable from ±0.2°F to ±2°F. For Example: A swing setting of 0.5°F will turn the heating on at approximately 0.5°F below the setpoint and turn the heating off at approximately 0.5°F above the setpoint.	Pick PA or FU PA = partial keypad lockout, which locks all the keys except the  or  keys. FU = Full keypad lockout, which locks out all the keys. Note: Keypad lockout instructions are below.
Factory Default Settings						
OFF	0°F	OFF	ON	0.5°F	0.4°F	PA

Note: To lock the keypad hold down the  and  keys for 3 seconds. You will see a lock in the display. To unlock the keypad hold down the  and  keys for 3 seconds.

TECH SETUP
STEPS CONTINUED
ON THE NEXT PAGE



Tech Setup Steps (Continued from the previous page)

Heating Temperature Setpoint Limit	Cooling Temperature Setpoint Limit	°F or °C	12 or 24 Hour Clock	Morning Recovery	Program Options	Time Periods
This feature allows you to set a maximum heat setpoint value. The setpoint temperature cannot be raised above this value.	This feature allows you to set a minimum cool setpoint value. The setpoint temperature cannot be lowered below this value.	Select F for Fahrenheit temperature read out or select C for Celsius read out.	You can select either a 12 or 24 hour clock setting.	This feature turns your system on before the WAKE programming time to ensure the environment is at the WAKE setpoint when the WAKE time period begins. This recovery changes over time based on the previous day's experience.	You can configure this thermostat to have a 7 day program, a 5+1+1 program or nonprogrammable.	You can configure this thermostat to have 2 or 4 programmable time periods per day. 2time periods is Occupied/Unoccupied 4 time periods is Wake, Leave, Return, Sleep.
LCD Will Show						
						
Adjustment Options						
Use the ◀ or ▶ key to select the maximum heat setpoint.	Use the ◀ or ▶ key to select the minimum cool setpoint.	°F for Fahrenheit °C for Celsius	Use the ◀ or ▶ key to select 12 or 24 hour clock.	Use the ◀ or ▶ key to turn on or off.	Use the ◀ or ▶ key to select 7d for 7 day, 5d for 5+1+1, or 0d for nonprogrammable.	Use the ◀ or ▶ key to select 2 or 4 time periods per day.
Factory Default Settings						
90 °F	44 °F	°F	12 Hour Clock	ON	5d	4

TECH SETUP
STEPS CONTINUED
ON THE NEXT PAGE

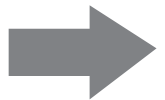

Swing Setting Tip

The second stage will turn on at 2x the swing setting. The second stage will turn off when 1x the swing is reached. For example, if the swing setting is .8 degrees for heating and the thermostat is set at 70°F, the first stage will turn on at approximately 69.2°F. The second stage will turn on at 68.4°F. The second stage will turn off at 69.2°F and the first will turn off at 70.8°F. If third stage is used, it will turn on at 3x the swing and turn off at approximately 2x the swing.

Tech Setup Steps (Continued from the previous page)

Display Light	Contractor Call Number	Beep	Heat Pump	System Switch	Fan Operation	Gas Auxiliary for Heat Pump	Cooling Fan Delay
<p>The display light can be configured to stay on at all times or come on when any key is pressed.</p> <p>NOTE: THERMOSTAT MUST BE HARDWIRED ONLY, Keeping the display light continually "ON" will greatly reduce battery life.</p>	<p>Allows you to put your phone number in the display.</p> <p>You can choose ON or OFF</p>	<p>When any key is pressed an audible beep will sound.</p> <p>You can choose ON or OFF</p>	<p>When turned on the thermostat will operate a heat pump.</p> <ol style="list-style-type: none"> EM.Heat will show as an option in the system switch. Y will be first stage of heat & cool, W/E will be emergency heat relay & W2 will be auxiliary heat relay. 	<p>You can configure the system switch for the particular application:</p> <p>Heat - Off - Cool, Heat - Off, Cool - Off, Heat - Off - Cool-Auto</p> <p>Note: EM. Heat will show if in heat pump mode.</p>	<p>Select GAS for systems that control the fan during a call for heat.</p> <p>Select ELEC to have the thermostat control the fan during a call for heat.</p>	<p>This option will turn the heat pump off 45 seconds after the auxiliary heat relay turns on.</p> <p>For 2 heat applications, the first stage will turn off 45 seconds after the auxiliary stage turns on.</p> <p>For 3 heat applications, the first and second stage will turn off 45 seconds after the auxiliary stage turns on.</p>	<p>The cooling fan delay setting will delay the fan from coming on in cool mode and keep running after the compressor shuts off for a short time to save energy in some systems.</p>

LCD Will Show



Adjustment Options

<p>OFF configures display light to come on when the light key is pressed.</p> <p>ON configures the display light to stay on.</p> <p>Use the < or > key to turn on or off.</p>	<p>If selected ON, you will see the input screen after pressing next step.</p> <p>Use the < or > key to select the desired number and the FAN or SYSTEM key to move from one character to another. See note below on operation.</p>	<p>If ON is selected the beep will sound.</p> <p>If OFF is selected, there is no sound.</p>	<p>OFF configures the thermostat for non heat pump systems.</p> <p>ON configures the thermostat for heat pump systems.</p>	<p>Use the < or > key until the desired application is flashing.</p>	<p>GAS or ELEC</p>	<p>For heat pump systems that are "dual fuel" (use a gas furnace for auxiliary stage heat) you can turn this feature on to turn off the heat pump when the auxiliary stage of heating has been called for.</p> <p>See Balance Point on page 13.</p>	<p>You can select the Cooling Fan Delay from OFF, 15, 30, 60 or 90 seconds.</p> <p>If 15, 30, 60 or 90 is selected the fan will not turn on for that many seconds when there is a call for cool and will run for that many seconds after satisfying a call for cool.</p> <p>This feature is disabled when a ROS-250W is used.</p> <p>See Balance Point on page 13.</p>
-------------------------------------------------------------------------------------------------------------------------------------------------------------------------------------	-------------------------------------------------------------------------------------------------------------------------------------------------------------------------------------------------------------------------------------------	---------------------------------------------------------------------------------------------	----------------------------------------------------------------------------------------------------------------------------	----------------------------------------------------------------------------	--------------------	-----------------------------------------------------------------------------------------------------------------------------------------------------------------------------------------------------------------------------------------------------	------------------------------------------------------------------------------------------------------------------------------------------------------------------------------------------------------------------------------------------------------------------------------------------------------------------------------------------------------------------------

Factory Default Settings

ON	OFF	ON	OFF	Heat - Off - Cool	GAS	OFF	OFF
----	-----	----	-----	-------------------	-----	-----	-----

Note:

Connect an optional **ROS-250W** outdoor remote temperature sensor to enable the balance point tech setup option.

TECH SETUP
STEPS CONTINUED
ON THE NEXT PAGE



Tech Setup Steps (Continued from the previous page)

Requires ROS-250W

Outdoor Sensor	Remote Sensor	Finding Sensor	Local Temp Sensor	Freeze Protection	Stages of Heat	Balance Point (Gas Auxiliary ON)	Balance Point (Gas Auxiliary OFF)
<p>Enables the use of an outdoor sensor ROS-250W.</p> <p>Connecting a ROS-250W allows for a balance point setting.</p> <p>Selecting YES requires the S-955WH master thermostat to be powered with 24V on C and R terminals.</p> <p>See ROS-250W user guide for more information.</p>	<p>Enables the use of up to four indoor sensors RIS-251W</p> <p>Selecting YES requires the S-955WH master thermostat to be powered with 24V on C and R terminals.</p>	<p>This step connect RIS-251W to S-955WH.</p> <p>The previous step Remote Sensor must be set to YES in order to connect an RIS-251W.</p>	<p>Disable the sensor on the master.</p> <p>At least one RIS-251W indoor remote sensor must be connected to disable the local S-955WH sensor.</p>	<p>Turns on the heat for 10 minutes each hour if unable to communicate with the S-955WH master thermostat if there has been a call for heat in the last 24 hours.</p>	<p>You can configure the thermostat to operate a 3 stage heat pump system.</p> <p>2H 2C = 2 heat, 2 cool 3H 2C = 3 heat, 2 cool</p> <p>This feature only shows if Technician Setup Step for HEAT PUMP is set to ON.</p>	<p>Balance point can eliminate the need for fossil fuel kit. An outdoor temperature above balance point will cause the thermostat to only allow the Y terminal(s) to energize. An outdoor temperature below balance point will cause the thermostat to only allow W2 to energize.</p> <p>Note: Only shows up if Heat Pump is set to YES. Outdoor Sensor is turned ON, and GAS Auxiliary is turned ON.</p>	<p>Balance point with electric auxiliary can optimize Heat Pump usage. An outdoor temperature above balance point will cause the thermostat to only allow the Y terminal(s) to energize. An outdoor temperature below balance point will cause the thermostat to allow the Y terminal(s) and the W2 terminal to energize.</p> <p>Note: Only shows up if Heat Pump is set to YES and Outdoor Sensor is turned ON and GAS Auxiliary is turned OFF.</p>

LCD Will Show

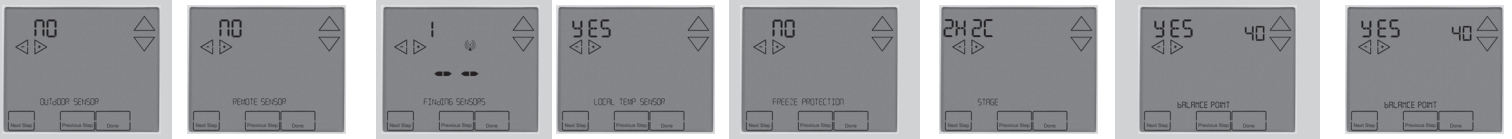

Adjustment Options

<p>When NO is selected the thermostat is unable to connect to an outdoor remote sensor ROS-250W.</p> <p>When YES is selected the thermostat is able to connect to an outdoor remote sensor ROS-250W.</p> <p>Press and hold connect button on ROS-250W until the S-955WH says FOUND OUTDOOR on display.</p>	<p>When NO is selected the thermostat is unable to connect to an indoor remote sensor RIS-251W.</p> <p>When YES is selected the thermostat is able to connect to up to four indoor remote sensors RIS-251W.</p> <p>Go to the next step FINDING SENSOR to connect RIS-251W.</p>	<p>The number shown represents the zone.</p> <p>Use < or > to select the zone you wish to connect.</p> <p>The zone setting on the S-955WH and the RIS-251W must be the same to connect.</p> <p>See RIS-251W user guide for detailed RIS-251W connection information.</p> <p>See note below for more information.</p>	<p>YES enables local S-955WH sensor</p> <p>NO disables local S-955WH sensor</p>	<p>YES enables freeze protection</p> <p>NO disables freeze protection</p>	<p>Use the < or > key to change between 2 heat and 3 heat.</p> <p>2 heat will use Y1 as first stage and W2 as auxiliary.</p> <p>3 heat will use Y1 as first stage, Y2 as second stage and W2 as auxiliary.</p>	<p>10, 20, 30, 35, 40, 45, 50 outdoor temperature balance point setting.</p> <p>NO</p>	<p>10, 20, 30, 35, 40, 45, 50 outdoor temperature balance point setting.</p> <p>NO</p>
------------------------------------------------------------------------------------------------------------------------------------------------------------------------------------------------------------------------------------------------------------------------------------------------------------	--------------------------------------------------------------------------------------------------------------------------------------------------------------------------------------------------------------------------------------------------------------------------------	----------------------------------------------------------------------------------------------------------------------------------------------------------------------------------------------------------------------------------------------------------------------------------------------------------------------------	---------------------------------------------------------------------------------	---------------------------------------------------------------------------	----------------------------------------------------------------------------------------------------------------------------------------------------------------------------------------------------------------------	----------------------------------------------------------------------------------------	----------------------------------------------------------------------------------------

Factory Default Settings

NO	NO	1	YES	NO	2 Stages	NO	NO
----	----	---	-----	----	----------	----	----

Note:

Up to four **RIS-251W** indoor temperature sensors can be connected to one **S-955WH**. This allows for 5 sensing points (zones). For Example: The local (**S-955WH**) plus four **RIS-251W** sensors enables 5 sensing points. To connect an **RIS-251W** to a **S-955WH**, Select **1** on the **S-955WH FINDING SENSOR** technician setup step. Then select Zone **1** on the **RIS-251W** technician setup step. Then hold down the light button on the **RIS-251W** until it beeps, while in **ZONE** technician setup step on **RIS-251W**. To connect a second **RIS-251W** change the **S-955WH** to read **2** and change the **RIS-251W** to zone **2**. The zone setting must match between the **S-955WH** and the **RIS-251W** to connect. When the connection is established the **S-955WH** will show **FOUND + NAME OF RIS-251W** in the system information area of the display.





Requires RIS-250W	Tech Setup Steps (Continued from the previous page)			
Balance Run Time	Humidify	Dehumidify	Humidity Calibration	Dehumidify with AC
Balance point run time will allow the W2 auxiliary terminal to energize even if outdoor temperature is above the selected balance point temperature. If enabled, auxiliary will energize for their current cycle after the balance point run time has expired.	This feature adds humidity when System key is in Heat.	This feature removes humidity when System key is in Cool.	This feature allows the installer to change the calibration of the ambient humidity displayed.	This feature forces the A/C to run longer to remove humidity when needed. the A/C will "over cool" the room a few degrees until the humidity reaches the desired setpoint.
LCD Will Show				
Adjustment Options				
YES 15, 30, 45, 60, 75, 90 continuous run time minutes. NO	Use the ◀ or ▶ key to turn on or off. If ON is selected the humidity will be displayed on the main screen and Hum terminal will energize when humidity setpoint is above ambient humidity in Heat mode.	Use the ◀ or ▶ key to turn on or off. If ON is selected the humidity will be displayed on the main screen and DHM terminal will energize when humidity setpoint is below ambient humidity in Cool mode.	Use the ◀ or ▶ key to adjust the calibration +/- 3.	Use the ◀ or ▶ key to select YES or NO. If selected Yes, allows over cooling to be used to control humidity in Cool mode. If NO is selected the system will not use over cooling.
Factory Default Settings				
NO	OFF	OFF	0	NO

Balance Point:

The system operates differently when a balance point is used. On a dual fuel system, the balance point outdoor temperature setting will be the outdoor temperature at which the thermostat chooses either the heat pump or gas furnace. For Example: A balance point setting of 30°F will turn on only the heat pump above 30°F and only the gas furnace below 30°F. **Y1** will be stage one above 30°F and **W2** will be stage one below 30°F.

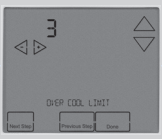
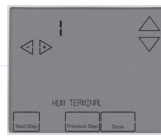
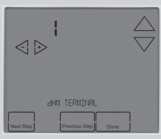
A heat pump with electric auxiliary will energize the heat pump above and below balance point. The electric auxiliary will only energize below balance point. For Example: A Balance point setting of 40°F, will turn on the heat pump above 40°F and turn on the heat pump and electric auxiliary below 40°F.

Tech Setup Steps (Continued from the previous page)

Over Cool Limit	HUM Terminal	DHM Terminal	Dehumidify Relay	Satisfy Setpoint	Staging Delay
The amount of over cooling allowed when using A/C to remove humidity. This screen is only shown when ON is selected in the "Dehumidify with AC" tech setup step.	Options for how the HUM terminal energizes.	Option for how DHM terminal energizes. Note: Set as option 1 if DEHUM with AC is set to YES.	You can configure the D Terminal as Normally-Open or Normally-Closed. NO = Normally-Open NC = Normally-Closed	This feature allows the thermostat to keep multiple stages of heat or cool energized until setpoint is satisfied.	This feature allows a delay to occur when a second and third stage is needed. This allows the previous stage extra time to satisfy setpoint.
LCD Will Show					
					
Adjustment Options					
Use the ◀ or ▶ key to select the maximum number of degrees of over cool. Options are: 2, 3, 4, 5	Use the ◀ or ▶ key to select one of the four options. View the HUM Terminal chart below for an explanation of these options.	Use the ◀ or ▶ key to select one of the four options. View the DHM Terminal chart below for an explanation of these options.	Use the ◀ or ▶ key to select NO or NC. If NO is selected, D will energize to dehumidify. If NC is selected, D will be normally energized. D will de-energize to dehumidify.	Use the ◀ or ▶ key to turn on or off.	Use the ◀ or ▶ key to select the number of minutes to delay each stage. OFF 5, 10, 15, 30, 45, 60, 90 delay minutes.
Factory Default Settings					
3	1	1	NO	OFF	OFF

Note:
When the Dehumidify terminal is configured a Normally-Closed, the Base Module D terminal LED indicator will be lit when the relay is closed. When the thermostat calls for Dehumidification, the D terminal LED indicator will turn off.

HUM Terminal



OPTIONS	HUM terminal energizes when the ambient humidity is...
1	below the humidity setpoint and heat or fan is energized.
2	below the humidity setpoint and heat is energized.
3	below the humidity setpoint. It will also energize the fan during a call for humidity.
4	below the humidity setpoint.

DHM Terminal

OPTIONS	DHM terminal energizes when the ambient humidity is...
1	above the humidity setpoint and cool or fan is energized.
2	above the humidity setpoint. It will also energize the fan during a call for humidity.
3	above the humidity setpoint.
4	above the humidity setpoint and the compressor is not running.

Follow the steps below to change your target humidity setpoint.

Press the **HUMIDITY** key

Use the  or  key to select the target humidity setpoint.

Press **DONE** when completed

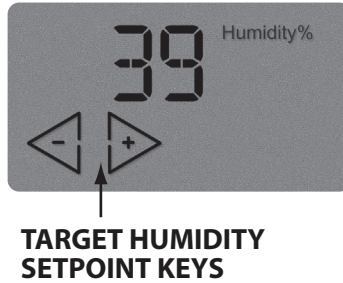

Note:

- The target humidity setpoint is not programmable. Unlike temperature, humidity does not change quickly and should not be programmed.
- Humidity is only energized during heat. Dehumidify is only energized during cool. Heat and Cool each have their own target setpoints.
- **D** and **H** Terminals use the **R** Terminal to complete the circuit. This is a normally open circuit.

HUMIDITY KEY

Ambient Humidity Display

Ambient humidity will flash opposite the day and time, if the optional **RIS-250W** outdoor temperature sensor is installed the ambient outdoor temperature will also cycle in the display.

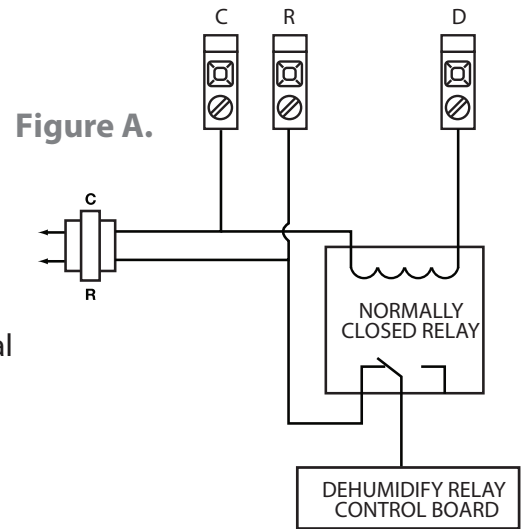

AMBIENT HUMIDITY



DAY & TIME



OUTDOOR TEMPERATURE

Increasing Humidity

The table on the right shows recommended indoor humidity levels in relation to outdoor temperatures during heating (adding humidity).







Outside Temperature (0°F)	Recommended Relative Humidity
+20° and above	35% to 40%
+10°	30%
0°	25%
-10°	20%
-20°	15%

Recommended Cooling Settings:

Consult your professional HVAC technician for recommended settings for your climate.

Set Time













Follow the steps below to set the day of the week and current time:

1. Press **MENU**
2. Press **SET TIME**
3. Day of the week will be flashing. Use the  or  key to select the current day of the week.
4. Press **NEXT STEP**
5. The current hour is flashing. Use the  or  key to select the current hour. When using 12-hour time, make sure the correct a.m. or p.m. choice is selected.
6. Press **NEXT STEP**
7. Minutes are now flashing. Use the  or  key to select current minutes.
8. Press **DONE** when completed

Programming

All our programmable thermostats are shipped with an energy saving pre-program. You can customize this default program by following the Set Program Schedule.

Your thermostat can be programmed to have each day of the week programmed uniquely (7days), all the weekdays the same with a separate program for Saturday and a separate program for Sunday (5+1+1), or nonprogrammable. There are four time periods for each day (**WAKE , LEAVE , RETURN , SLEEP**). This thermostat has a programmable fan feature, which allows you to run the fan continuously during any time period.











Factory Default Program					
Day of the Week	Events	Time	Setpoint Temperature (Heat)	Setpoint Temperature (Cool)	Zone (If TP-RIS-251W is connected)
Weekday	Wake 	6 a.m.	70° F (21° C)	75° F (24° C)	System Average
	Leave 	8 a.m.	62° F (17° C)	83° F (28° C)	System Average
	Return 	6 p.m.	70° F (21° C)	75° F (24° C)	System Average
	Sleep 	10 p.m.	62° F (17° C)	78° F (26° C)	System Average
Saturday	Wake 	8 a.m.	70° F (21° C)	75° F (24° C)	System Average
	Leave 	10 a.m.	62° F (17° C)	83° F (28° C)	System Average
	Return 	6 p.m.	70° F (21° C)	75° F (24° C)	System Average
	Sleep 	11 p.m.	62° F (17° C)	78° F (26° C)	System Average
Sunday	Wake 	8 a.m.	70° F (21° C)	75° F (24° C)	System Average
	Leave 	10 a.m.	62° F (17° C)	83° F (28° C)	System Average
	Return 	6 p.m.	70° F (21° C)	75° F (24° C)	System Average
	Sleep 	11 p.m.	62° F (17° C)	78° F (26° C)	System Average

INSTALLATION MANUAL

PROGRAMMING THE THERMOSTAT

Factory Default Program for 2 Time Periods				
Day of the week	Events	Time	Setpoint Temperature (Heat)	Setpoint Temperature (Cool)
Weekday	Occupied	8 a.m.	70° F (21° C)	73° F (23° C)
	Unoccupied	6 a.m.	64° F (18° C)	80° F (27° C)
Saturday	Occupied	8 a.m.	70° F (21° C)	73° F (23° C)
	Unoccupied	6 a.m.	64° F (18° C)	80° F (27° C)
Sunday	Occupied	8 a.m.	70° F (21° C)	73° F (23° C)
	Unoccupied	6 a.m.	64° F (18° C)	80° F (27° C)

You can use the table below to plan your customized program schedule if using 5+1+1

Programming Table				
Day of the week	Events	Time	Setpoint Temperature (Heat)	Setpoint Temperature (Cool)
Weekday	Wake 			
	Leave 			
	Return 			
	Sleep 			
	Occupied			
	Unoccupied			
Saturday	Wake 			
	Leave 			
	Return 			
	Sleep 			
	Occupied			
	Unoccupied			
Sunday	Wake 			
	Leave 			
	Return 			
	Sleep 			
	Occupied			
	Unoccupied			

Set 5+1+1 Program Schedule

To customize your 5+1+1 program schedule, follow these steps

Weekday:





1. Select **HEAT** or **COOL** using the **SYSTEM** key.
Note: You have to program heat and cool each separately.
2. Press **MENU**
3. Press **SET SCHED**. Note: Monday-Friday is displayed and the **WAKE** icon is shown. You are now programming the **WAKE** time period for the weekday setting.

Additional step if RIS-251W indoor remote sensor is connected.



The **S-955WH** master thermostat will either average all sensors (system average) or only use one sensor for the system ambient temperature (priority). The default setting is **SYSTEM AVERAGE**, which means all sensors are averaged to create the system average ambient temperature reading. The **NEXT ZONE** key can be pressed to change the priority. The system information area of the display shows the priority.

For Example: There is an **RIS-251W** connected and it is named **REMOTE 1**. If the **NEXT ZONE** key is pressed until **REMOTE 1** is shown, then the **REMOTE 1** ambient temperature reading will be used exclusively for that time period. All other sensors will be ignored.

4. Time is flashing. Use the  or  key to make your time selection for the weekday **WAKE** time period. Note: If you want the fan to run continuously during this time period, select **ON** with the **FAN** key.
5. Press **NEXT STEP**
6. The setpoint temperature is flashing. Use the  or  key to make your setpoint selection for the weekday **WAKE** period.
7. Press **NEXT STEP**
8. Repeat steps 4 through 7 for weekday **LEAVE** time period, for weekday **RETURN** time period, and for weekday **SLEEP** time period.

Saturday:

9. Repeat steps 4 through 7 for Saturday **WAKE** time period, for Saturday **LEAVE** time period, for Saturday **RETURN** time period, and for Saturday **SLEEP** time period.

Sunday:

10. Repeat steps 4 through 7 for Sunday **WAKE** time period, for Sunday **LEAVE** time period, for Sunday **RETURN** time period, and for Sunday **SLEEP** time period.

Set 7 Day Program Schedule

To customize your 7 day program schedule, follow these steps:

Monday





1. Select **HEAT** or **COOL** using the system key. You have to program heat and cool each separately.
2. Press **MENU**
3. Press **SET SCHED**
Note: Monday is displayed and the **WAKE** icon is shown. You are now programming the **WAKE** time period for the Monday setting.

Additional step if RIS-251W indoor remote sensor is connected.



The **S-955WH** master thermostat will either average all sensors (system average) or only use one sensor for the system ambient temperature (priority). The default setting is **SYSTEM AVERAGE**, which means all sensors are averaged to create the system average ambient temperature reading. The **NEXT ZONE** key can be pressed to change the priority. The system information area of the display shows the priority.

For Example: There is an **RIS-251W** connected and it is named **REMOTE 1**. If the **NEXT ZONE** key is pressed until **REMOTE 1** is shown, then the **REMOTE 1** ambient temperature reading will be used exclusively for that time period. All other sensors will be ignored.

4. Time is flashing. Use the  or  key to make your time selection for the Monday **WAKE** time period. **Note:** If you want the fan to run continuously during this time period, select **ON** with the **FAN** key.
5. Press **NEXT STEP**
6. The setpoint temperature is flashing. Use the  or  key to make your setpoint selection for the Monday **WAKE** period.
7. Press **NEXT STEP**
8. Repeat steps 4 thru 7 for Monday **LEAVE** time period, for Monday **RETURN** time period, and for Monday **SLEEP** time period.

Tuesday, Wednesday, Thursday, Friday, Saturday, Sunday

Repeat steps 4 thru 7 for the remaining days of the week.

A Note About Auto Changeover:

If in Auto you have the ability to switch between Auto Heat or Auto Cool by pressing the System key. This can be done once the current mode has reached its set-point. For example: if in Auto Heat, the heat setpoint must be satisfied before the thermostat will allow you to switch to Auto Cool. You can switch out the Auto by holding down the System key. To get back into Auto, you must toggle the System key to Auto.

A Note About Programmable Fan:

The programmable fan feature will run the fan continuously during any time period it is programmed to be on. This is the best way to keep the air circulated and to eliminate hot and cold spots in your building.

Specifications

The display range of temperature	41°F to 95°F (5°C to 35°C)
The control range of temperature	44°F to 90°F (7°C to 32°C)
Load rating	1 amp per terminal, 1.5 amp maximum all terminals combined
Display accuracy	± 1 °F
Swing (cycle rate or differential)	Heating is adjustable from 0.2°F to 2.0°F Cooling is adjustable from 0.2°F to 2.0°F
Power source	18 to 30 VAC, NEC Class II, 50/60 Hz for hardwire (common wire) Battery power from 2 AA Alkaline batteries
Operating ambient	32°F to +105°F (0° to +41°C)
Operating humidity	90% non-condensing maximum
Dimensions of thermostat	4.7 "W x 4.4 "H x 1.1"D
Frequency	916 MHz

Base Module

Load rating	1 amp per terminal, 1.5 amp maximum all terminals combined
Power source	18 to 30 VAC, NEC Class II, 50/60 Hz
Operating ambient	32°F to +150°F (0° to +65°C)
Operating humidity	90% non-condensing maximum