

★ Western Distribution Center

11335 Greenstone Avenue
Santa Fe Springs, California
90670 • USA

tel: (562) 466-1000
fax: (562) 466-1010

★ Central Distribution Center

13800 John F Kennedy Blvd
Suite #100
Houston, Texas
77039 • USA

tel: (713) 460-3200
fax: (713) 460-3203

★ Southern Distribution Center

3509 Port Jacksonville Pkwy
Building #1
Jacksonville, Florida
32226 • USA

tel: (912) 330-8270
fax: (912) 330-8271

★ Eastern Distribution Center

300 Principio Parkway West
North East, Maryland
21901 • USA

tel: (410) 272-3850
fax: (410) 272-3852



Truair's factory located in Vietnam

★ Los Angeles, CA

★ North East, MD

★ Houston, TX

★ Jacksonville, FL

TRUaire
A BREATH OF FRESH AIR

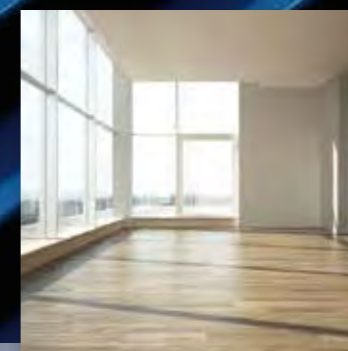
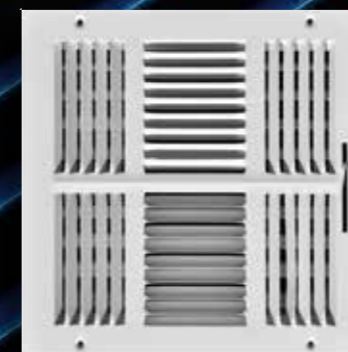
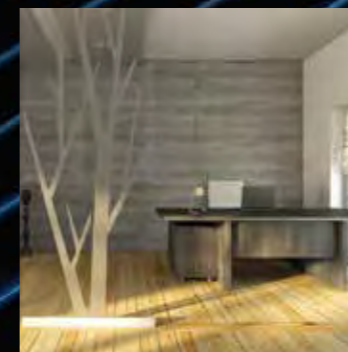

TRUaire
PRODUCT CATALOG

toll free: (888) 878-2473 (TRUAIRE) • www.truair.com

REGISTERS • GRILLES • DIFFUSERS

PRODUCT CATALOG

Regional Distribution Centers

Santa Fe Springs, California
 Western Distribution Center &
 Corporate Offices

11335 Greenstone Avenue
 Santa Fe Springs, CA 90670

PH 562-466-1000 Fax 562-466-1010

Jacksonville, Florida
 Southern Distribution Center

3509 Port Jacksonville Pkwy., Building #1
 Jacksonville, FL 32226

PH 912-330-8270 Fax 912-330-8271

Houston, Texas
 Central Distribution Center

13800 John F Kennedy Blvd. Suite #100
 Houston, TX 77039

PH 713-460-3200 Fax 713-460-3203

Baltimore, Maryland
 Eastern Distribution Center

300 Principio Parkway West
 North East, MD 21901

PH 410-272-3850 Fax 410-272-3852

*We're Here
 to Serve You...*

Los Angeles, CA

North East, MD

Jacksonville, FL

Houston, TX

Strategic Distribution

In order to be recognized for providing the highest quality service in our industry, we must maintain strategic geographical distribution locations. We currently have four distribution centers across the country: Los Angeles, CA, Houston, TX, Jacksonville, FL and Baltimore, MD. These four distribution centers represent over 500,000 sq. ft. of finished goods in inventory.

Maintaining huge inventories means filling orders complete and quicker than any of our competitors. Our 4 distribution centers are situated so that 90% of our customers receive there shipments within 72 hours after they place there orders.

When you consider that TRUaire is providing the highest quality and service to the market at competitive prices, the rest is a winning combination for your customers.

Unmatched Quality

Often times as consumers we're faced with the stark reality that we are living in an era where quality is often compromised; an era in which economy trumps real value, and quality takes a backseat to a quick discount. This is not the case at TRUaire. We believe quality still means value, and we are strongly committed to keeping this value.

"The bitterness of poor quality remains long after the sweetness of low price is forgotten".

— Benjamin Franklin



*For more information about your Region please give us a call...
 or feel free to visit us online.*

Welcome

Welcome to the newest edition of the TRUaire catalog. In these pages we hope you will find the most user-friendly product catalog in the industry.

Feel free to open the catalog to any page. Notice that no matter what page you've chosen that both pages contain information for the same product making it even easier to order and compare models. Everything you want to know for that particular model is right there in front of you with some of the features listed on the left, and some information for that series listed on the right. No need to flip back and forth from page to page for that model to find exactly what you need.



Our Mission

As a nationally recognized leading manufacturer of grilles, registers and diffusers for the Heating and Air Conditioning Industry, TRUaire is focused on providing the highest quality standards in the industry through innovation, customer care, and expertise. TRUaire takes pride in its dynamic workplace, offering each employee the necessary support to realize their full potential.

Every member of this impassioned team has helped to carve each step of TRUaire's success story with hard work, superior products, exceptional customer service, and the largest inventory of finished goods in the industry. TRUaire always puts its customers first, striving to be courteous, respectful, and honest in every circumstance: as the greatest successes are achieved through genuine partnership.

The Right Choice.

TRUaire has been producing a wide variety of outstanding products for the heating & air conditioning industry for over 30 years. When you select TRUaire, you're choosing a company that prides itself on decades of experience, superior customer service and the highest quality products that are sure to exceed your expectations.

We are in the business to sell the highest quality grilles, registers and diffusers we can build at the most competitive prices possible.



Our Vision

Today's business leaders agree that the best way to succeed in our competitive global market is to obtain full customer satisfaction by consistently manufacturing the highest quality products, on time delivery and quality customer service. These three keys to success are what TRUaire was founded on, but we know that we must strive to continually improve our operational processes, create value-added relationships with our customers as well as continually enhancing our employee's expertise in the field of grilles, registers and diffusers.

You'll also notice that each 2-page set is designed for consistency and formatted for ease of use and quick-reference. Flip through a few pages and you will quickly get the hang of the layout. Each left hand page includes general information; a brief description, pictures, features, and cross-reference information. Each right-hand page gives more specific information; options, dampers, drawings, available sizes, carton quantity, and information to help you when ordering.



We have you covered...









For quick reference, inside the front cover you'll find all of our locations and contact information, and in the back, a current up to date reference by Model Comparison and Manufacturer.

You can always visit us 24/7 online and stay connected with your mobile device or smartphone at www.truaire.com. Our website's features are always changing and updating to keep up with your needs in the field.



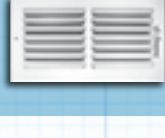

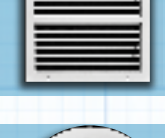

Quick and easy access at your fingertips. Call by phone, visit online or on any mobile device or smartphone.



Sidewall/Ceiling Supply Grilles & Registers
STEEL PRODUCTS



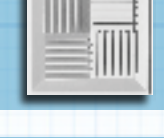



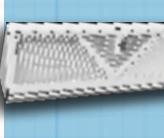

	PAGE
 100 Series Stamped Louver Register 1/2" or 1/3" Blade Spacing	01
 210/230 Series Adjustable Single Deflection	03
 220 Series Adjustable Double Deflection	05
 300 Series Adjustable Curved Blade	07
 400 Series Stamped Curved Blade	09
 560 Series High Capacity Square Direction Diffuser	11
 600 Series Evaporative Cooler Make-Up Diffuser	13
 700 Series High Velocity Flush Diffuser	15
 800 Series Round Ceiling Diffuser Surface Mounted	17

Sidewall/Ceiling Supply Grilles & Registers
ALUMINUM PRODUCTS





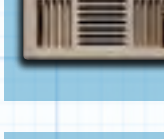
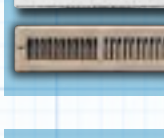

	PAGE
 A210 Series Adjustable Single Deflection	21
 A220 Series Adjustable Double Deflection	23
 A300 Series Adjustable Curved Blade	25
 A400 Series Stamped Curved Blade	27
 A500 Series Direction Diffuser Surface Mounted	29
 A520 Series Modular Core Diffuser Surface Mounted	31
 A540 Series Direction Diffuser Surface Mounted	33
 A900 Series Egg Crate/Perforated Face Grilles Surface Mounted	71

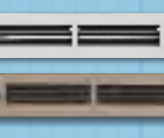

**Floor and Baseboard
Grilles and Registers**

	PAGE
 115/118/121 Series Baseboard Sunburst Register	35
 Designer Baseboards Steel & Resin Composite Designer Baseboard Registers	37
 121S Series Steel Deluxe Baseboard Register	39
 122/123 Series Steel Baseboard Grille 1/4" & 3/4" Turn Back	41
 123M/124M Series 1/3" Spaced Blade Sidewall Baseboard Registers	43
 125T Series 1/3" Spaced Blade Supply & Return Registers	43
 150M Series Steel Floor Registers	45
 150TS Series Steel Toe Space Grilles	47
 154 Series Steel Heavy Duty Floor Grilles	49
 160 Designer's Series Steel & Resin Composite Decorative Floor Registers	51

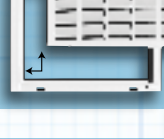
**Floor and Baseboard
Grilles and Registers (Cont'd)**

	PAGE
 168 Solid Oak Series Baseboard, Floor, Sidewall & Flush Mount	53
 173 Series Steel Toe Space Grilles	47
Sidewall/Ceiling Return Grilles STEEL PRODUCTS	
 170/173 Series Stamped Louver Return Grille 1/2" or 1/3" Blade Spacing	55
 174 Series Stamped Fixed Curved Blade Return Grille	55
 190/194 Series Stamped Louver Return Air Filter Grille - Fixed Hinge Face	57
 190RF/192RF/193RF Series Stamped Louver Return Air Filter Grille - Removable Face	59
 270 Series Fixed Bar Return Air Grille	61
 290/292/294 Series Fixed Bar Filter Grille Fixed Hinge	63

Sidewall/Ceiling Return Grilles

ALUMINUM PRODUCTS



A170 Series
Stamped Louver Return Air Grille
1/2" Blade Spacing



A270 Series
Fixed Bar Return Air Grille



A290 Series
Fixed Bar Return Air Filter Grille
Fixed Hinge

T-Bar Grilles & Diffusers



1010/1020MAS Series
Lay-In Fixed Perforated
Face Diffusers

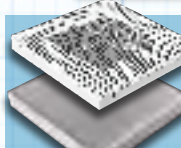

1120S Series
Lay-In Plenum Frame
Perforated Face or Egg Crate



1110 Series
Lay-In Stamped Louver Return
Air Grille - 1/2" Blade Spacing

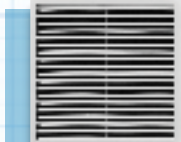

1210 Series
Lay-In Fixed Bar Return
Air Grille

PAGE

65

67

69

73

75

79

79

Lay-In Fixed Bar Return Grilles



1400 Series
Perforated Hinged Face
Curved Blade



1400 Series
Perforated Hinged Face
Adjustable Blade



1400 Series
Perforated Face Return Grille
Perforated Face Supply Grille



1900 Series
Lay-In Grille
Perforated Face



1900 Series
Lay-In Egg Crate Grille
1930 - Acrylic
1940 - Aluminum



2000 Series
Lay-In Plaque &
Step Down Cone Diffuser



2600 Series
Lay-In Stamped Curved
Blade Diffuser



4000 Series
Return Air Filter Grille - Stamped Face
Return Air Filter Grille - Bar Type

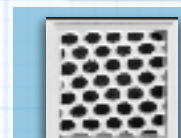

4000 Series
Return Air Filter Grille
Perforated Face



4000 Series
Return Air Filter Grille
Acrylic Eggcrate
Aluminum Eggcrate

PAGE

77

77

77

81

81

83

85

87

87

87

Lay-In Fixed Bar Return Grilles (Cont'd)



5200 Series
Lay-In Modular Core Diffuser



5400 Series
Lay-In Directional Diffuser

Spiral Duct Grilles & Registers



SU Series
Universal Mount Spiral Duct Grille
Single & Double Deflection



SD Series
Saddle Mount Spiral Duct Grille
Single & Double Deflection



SF Series
Flush Mount Spirale Duct Grille
Single & Double Deflection

Linear Slot Diffuser



LD/LDR Series
Linear Slot Diffusers
Linear Slot Returns



LB Series
Linear Bar

Packaged Terminal Air Conditioners (PTAC)



PTA Series
PTA 170 - PTAC Grille
Aluminum Stamped Louver



PTA Series
PTA 270/ 271/ 272 - PTAC Grilles
Extruded Aluminum Fixed Bar

PAGE

89

91

93

95

97

99

99

101

101

Access Panels



ACD690/670 Series
Small Single Access Panel



ACD2400 Series
Ceiling Sectional Access Panel
Solid or Louvered



ACP Series
Ceiling Access Panel
Solid or Louvered



AWD Series
Access Wall Door
Solid or Louvered

Round Commercial Diffusers



880 Series
Round Diffuser
Duct Mounted

Accessories

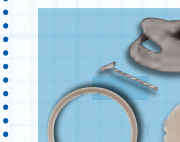

Butterfly Damper & Ring
Butterfly Damer (no Ring)
Mounting Ring



Radial Damper
Ring Collar & Push Pin Fasteners
Square to Round Transition



5000XF Surface Mounting Frame
Aluminum Opposed Blade Damper
Insulated Back



5000P T-Bar Panel
Louvered Foundation Vent
5400SD T-Bar Panel

PAGE

103

105

107

109

19

111

112

113

114

Find what you need quickly and easily. Give us a call today or visit us online: www.truair.com

SmoothGlide™

REGISTERS & GRILLES

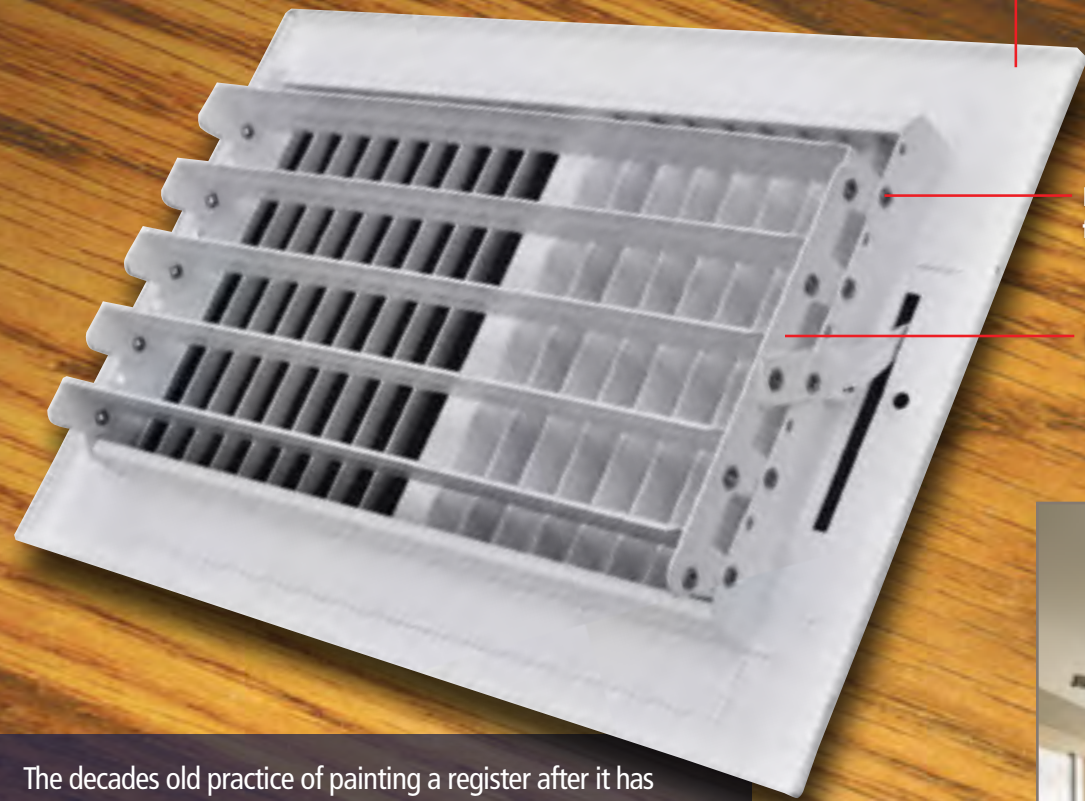

High quality steel or aluminum components.

Rivets installed AFTER powder-coating for the smoothest operation.

Blade & linkage components individually powder-coated BEFORE assembly.

The decades old practice of painting a register after it has been assembled leads to chipping paint, unpainted exposed surfaces, frozen linkage parts, rattling damper blades, and ultimately...rust. The process saves time and money. It's the best way to build a cheap register cheaply. We can't and won't ever build our registers that way again.



High quality steel or aluminum components.

Easy to use filter grille SmoothGlide™ latch is powder-coated BEFORE installation and requires no screwdriver to open.

TRUaire

REGISTERS & GRILLES™

TRUaire

PRODUCT SHOWCASE - EDITION 4



100 Series

TRUaire's 100 series style registers have been the mainstay of new residential construction for more than 50 years. Truair's Stamped registers are a cost-effective solution for residential applications and come in 1-way, 2-way, 3-way and 4-way air throw patterns. The grille face can be ordered with either 1/2" or 1/3" louvered blade spacing. They can be easily installed in sidewalls and ceilings. These registers can be ordered with an optional aluminum opposed blade damper that has a screwdriver adjustment which is accessible through the face of the registers.



Model 101MD

One Way Down
1/2" Blade Spacing

Model 101ML

One Way Left
1/2" Blade Spacing

Model 101MR

One Way Right
1/2" Blade Spacing



Model 102M

Two Way 1/2" Blade Spacing

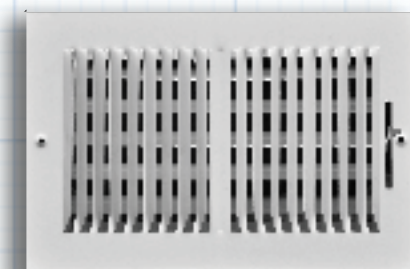

Model 103M

Three Way 1/2" Blade Spacing

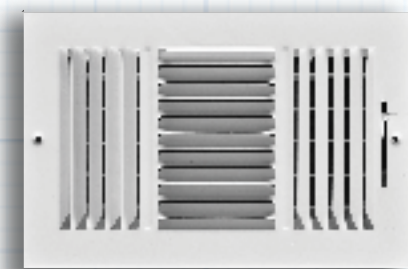

Model 132M

Two Way 1/3" Blade Spacing



Model 104M

Four Way 1/2" Blade Spacing

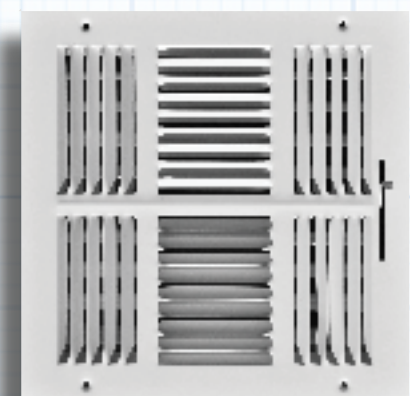

Model 133M

Three Way 1/3" Blade Spacing



Compare to:

	101M	102M	103M	104M	122M	123M	132M
Hart & Cooley	681	682	683	684	-	657	661
Shoemaker	-	850	845	150	-	133	833
USAire	101M	102M	103M	104M	-	-	132M
Continental	21	22	23	24	-	BG31	32
Lima	SW1W	SW2W	SW3W	SW4W	-	671	632
Aimate	-	160	140	190	-	-	163

Features

- Steel construction
- Available in 1/2" and 1/3" blade spacing
- Countersunk screw holes
- SmoothGlide multi-shutter damper
- Pristine white powder coat finish
- Optional opposed blade damper

Product Detail

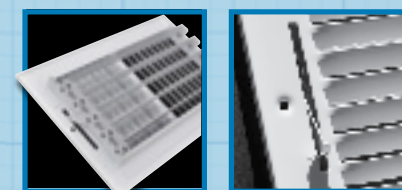

SmoothGlide dampers Countersunk Screw Holes

Throw Patterns:

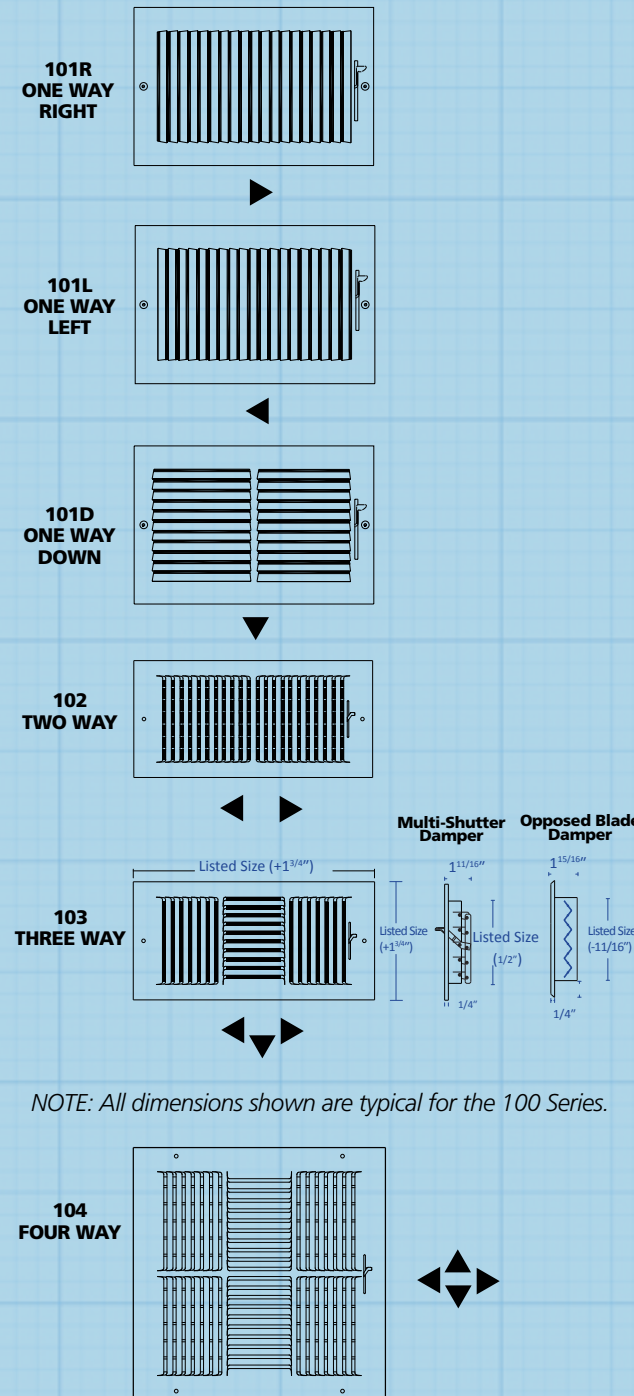

SIZES & CARTON QUANTITY CHART

	101M	102M	103M	104M	132M	133M
6x4		20	20		20	
6x6		20	20	20	20	
8x4	20	20	20		20	
8x6	20	20	20		20	
8x8		20	20	20	20	
10x4	20	20	20		20	
10x5		20				
10x6	20	20	20	20	20	20
10x8	20	20	20	20	20	
10x10	20	20	20	20	20	
12x4	20	20	20		20	
12x5		20				
12x6	20	20	20		20	20
12x8	20	20	20		20	
12x10		10	10		10	
12x12	10	10	10	20	10	
14x4	20	20	20		20	
14x5	20	20				
14x6	10	20	20		20	
14x8		10	10		10	
14x10		10	10	20		
14x12		10	10			
14x14		10	10	10		
16x4		20			20	
16x6	20	20	20		20	
16x8	10	10	10		10	
16x10		10	10			
16x12		10				
16x16				5		
18x4		20				
18x6		20	20		20	
18x8		10	10			
18x10		10	10			
18x12		10	10			
18x18	5	5		5		
20x4		20	20			
20x6		10	10		20	
20x8		10	10			
20x10		10				
20x12		10				
20x18		5				
20x20				5		
24x4		20				
24x6		10	10		10	
24x8		10	10			
24x10		5				
24x12		5				
24x14		5				
30x6		5			5	

Model Number Specifications

1 0 2 M D 1 8 x 0 8

- 1 = Stamped Louver Type
- 0 = Blade Spacing (0 = 1/2", 3 = 1/3")
- 2 = Number of Throw Directions (1 = 1 Way, 2 = 2 Way, 3 = 3 Way, 4 = 4 Way)
- M = Damper Option (M = Multi Shutter, O = Opposed Blade)
- D = Direction of Throw (1-Way Only) (D = Down, L = Left, R = Right)
- 18 = Grille Height
- 08 = Grille Width

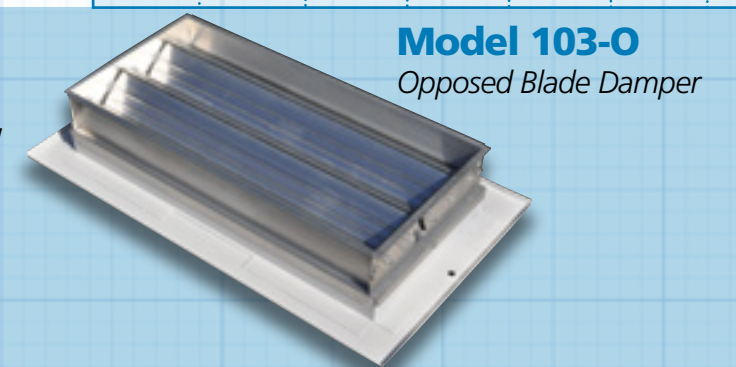

210 / 230 Series

Arguably the most versatile of all supply registers, the 210 Series Single Deflection register is available in a wide variety of configurations for almost any application. The highly effective open blade design and TRUaire's exclusive one piece frame allows for greater airflow. Our 210 Series is available with our unique SmoothGlide multi-shutter damper mechanism, a high quality opposed blade damper mechanism or without a damper.

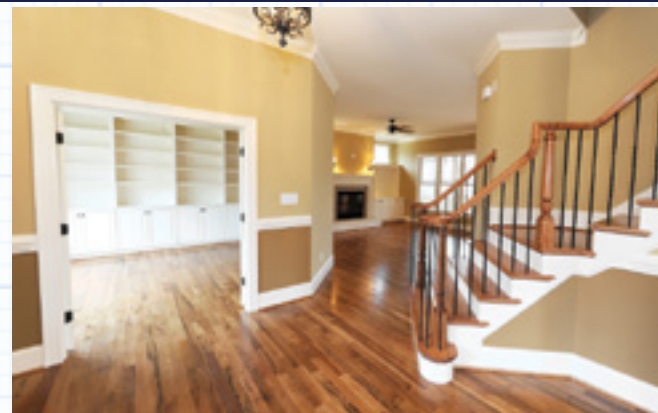

Model 210H
Adjustable Horizontal Blades
No Damper

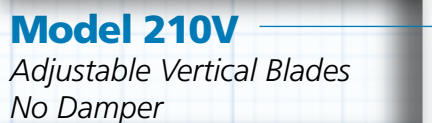

Model 210V
Adjustable Vertical Blades
No Damper



Model 210VM
Adjustable Vertical Blades
SmoothGlide Multi-Shutter Damper



Model 210HO
Adjustable Horizontal Blades
Opposed Blade Damper



Model 210VO
Adjustable Vertical Blades
Opposed Blade Damper



Model 230M
Adjustable 3-Way Blades
Multi-Shutter Damper

Compare to: 210VM 210VO 220VO 230M

Hart & Cooley	821	--	92VHO	--
Shoemaker	951	951-O	904-O	945
USAire	100SVM	--	--	--
Continental	RGV	RGV-O	--	--
Lima	900V	90VOBD	990VOBD	--
Airmate	220V	200VO	240V	--

Features

- Steel construction
- One piece frame (up to 14 x 10)
- 3/4" blade spacing
- Countersunk screw holes
- Unique beveled edges
- Individually adjustable horizontal or vertical blades
- Pristine white powder coat finish
- Optional SmoothGlide multi-shutter damper
- Optional opposed blade damper

Product Detail



Beveled Edges One Piece Frame Construction

Available Finishes

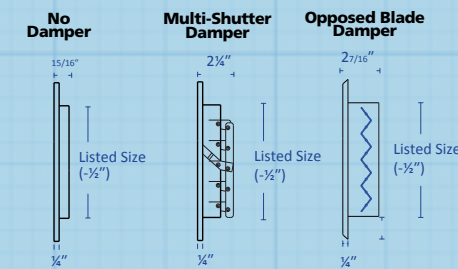

210 Series Options

Opposed Blade Damper (OBD)

Top notch craftsmanship includes nylon bushings to ensure the aluminum blades stay in place according to the airflow requirements.

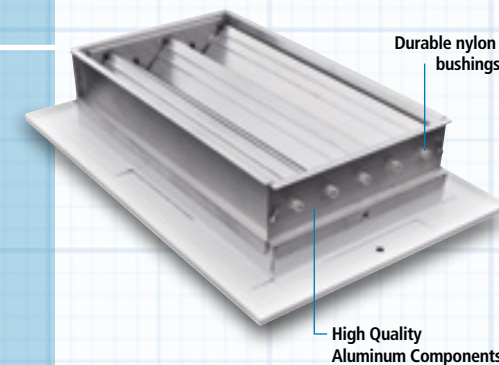

MODEL 210H

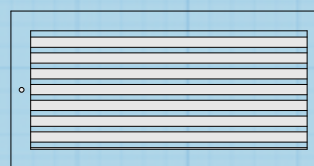

MODEL 210V

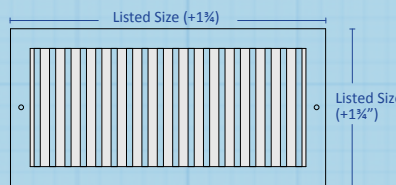

NOTE: All dimensions shown are typical for the 210 / 230 Series.

MODEL 230M

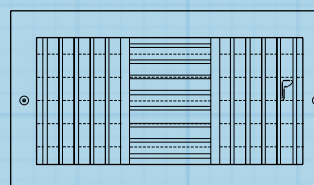

Model 230M
Three Way Fixed Bar
with adjustable damper



Reverse side shown with multi-shutter damper

Model Number Specifications

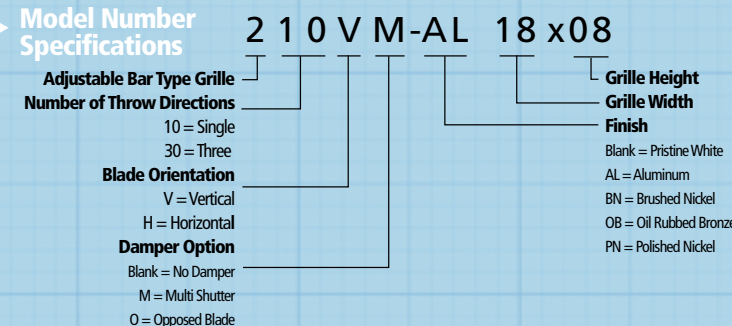

210/230M SERIES STOCKING SIZES AND CARTON QTY CHART

Register Size (IN)	MODEL						
	210H	210HM	210HO	210V	210VM	210VO	230VM
6 x 4					20	10	
6 x 6		20			20	10	
8 x 4	20	20			20	10	20
8 x 6			10		20	10	20
8 x 8					20	5	
10 x 4	20		10		20	10	20
10 x 6	20	20	5		20	5	20
10 x 8					20	5	20
10 x 10	10		5		10	5	10
12 x 4	20		10		20	10	
12 x 6	10	20			20	5	20
12 x 8					10	5	10
12 x 10					10	5	
12 x 12					10	2	10
14 x 4			5		20	5	
14 x 6	10	10	5		10	5	10
14 x 8		10	5	10	10	5	10
14 x 10					10	10	10
14 x 12					10	5	
14 x 14					5		5
16 x 4					10		
16 x 6					10	5	
16 x 8					10	2	
16 x 10					10		
16 x 12					5		
16 x 14					5		
16 x 16			2		5	2	
18 x 4					10		
18 x 6					10	5	
18 x 8					5	2	
18 x 10					5	2	
18 x 12					5	2	
18 x 14					5		
18 x 16					5		
18 x 18					5		
20 x 4					10		
20 x 6				10	10	2	
20 x 8					5	2	
20 x 10					5	5	
20 x 12					5		
20 x 14					5		
20 x 16					2		
20 x 18					2		
20 x 20					2		
22 x 10					5		
22 x 12					5		
22 x 14					5		
24 x 4					10		
24 x 6				5	5	5	
24 x 8					5	2	
24 x 10					5	2	
24 x 12					5	2	
24 x 14					2		
24 x 16					2		
24 x 18					2		
24 x 20					2		
24 x 24					2		
24 x 30					1		
26 x 8				5			
26 x 18					2		
30 x 4					5		
30 x 6					5	2	
30 x 8					5	2	
30 x 10					2		
30 x 12					2	1	
36 x 12					1	2	

220 Series

TRUaire's 220 Series Double-Deflection registers represent the top-of-the line adjustable bar-type product. These registers feature two perpendicular rows of individually adjustable blades for maximum air dispersion. Each model can be ordered with the horizontal row in front (Model 220H) or with the vertical row in front (Model 220V).

Whether commercial or residential, using an opposed blade damper or no damper at all, the 220 Series register delivers high capacity airflow with a sleek aesthetic style and solid construction.

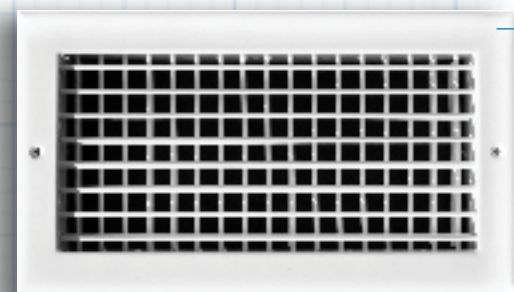

Model 220H
Adjustable
Horizontal Blades
No Damper



Model 220V
Adjustable Vertical Blades
No Damper

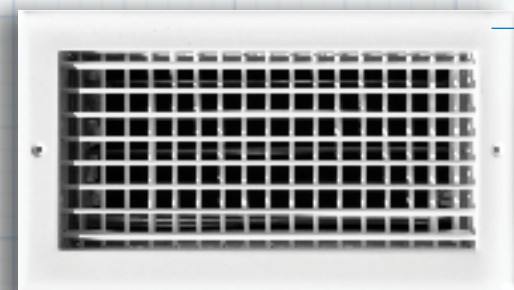

Model 220HO
Adjustable
Horizontal Blades in front
Opposed Blade Damper



Model 220VO
Adjustable
Vertical Blades in front
Opposed Blade Damper

Compare to: 220 Series

Hart & Cooley	92VHO
Titus	300RS
Shoemaker	934
Metal Aire	
Price	520S
Krueger	880V

Features

- Steel construction
- One piece frame (up to 14 x 10)
- 3/4" blade spacing
- Countersunk screw holes
- Unique beveled edges
- Individually adjustable horizontal and vertical blades
- Pristine white powder coat finish
- Optional opposed blade damper

Product Detail



Beveled Edges



Opposed Blade Damper with Nylon Bushings

Available Finishes

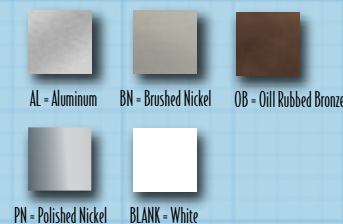

220 Series Options

Opposed Blade Damper (OBD)

Top notch craftsmanship includes nylon bushings to ensure the aluminum blades stay in place according to the airflow requirements.

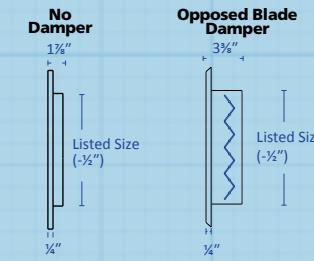

MODEL 220H

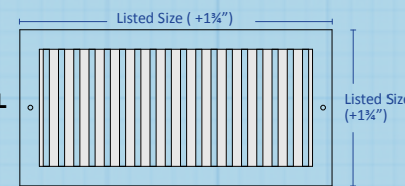

MODEL 220V

NOTE: All dimensions shown are typical for the 220 Series.

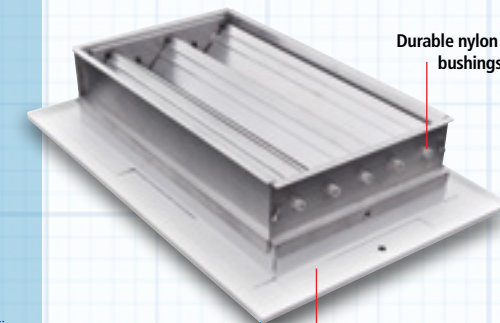

Model 220HO
Reverse side shown

Standard Configuration

Two perpendicular rows of individually adjustable blades.

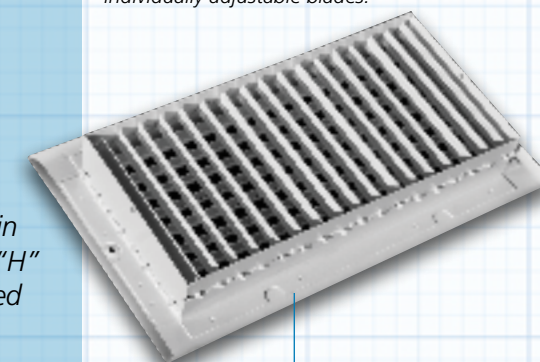

Model 220H
Reverse side shown

NOTE:

The Model 220 Series is available in over 60 sizes and configurations. "H" model configurations are not stocked in many sizes.

Model Number Specifications

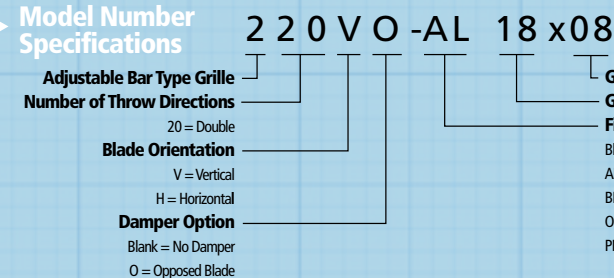

220 SERIES STOCKING SIZES AND CARTON QTY CHART

Register Size (IN)	MODEL			
	220H	220HO	220V	220VO
6 x 4				10
6 x 6	10	10	20	10
8 x 4	20		20	10
8 x 6		10	20	10
8 x 8				5
10 x 4		10		10
10 x 6	20	5	20	5
10 x 8			20	5
10 x 10				5
12 x 4				10
12 x 6	5	5	20	5
12 x 8		5		5
12 x 10			20	5
12 x 12		2		2
14 x 4				5
14 x 6		10	10	5
14 x 8		5		5
14 x 10				2
14 x 12				2
14 x 14				2
16 x 4				5
16 x 6			10	5
16 x 8			10	2
16 x 10			5	2
16 x 12			10	2
16 x 16				2
16 x 20			10	2
17 x 5			20	
18 x 4				5
18 x 6			10	5
18 x 8			10	2
18 x 10				2
18 x 12			10	2
18 x 18				2
20 x 4				2
20 x 6				2
20 x 8			5	2
20 x 10			5	2
20 x 12				2
20 x 14				2
20 x 16				2
22 x 6				2
22 x 8				2
22 x 10				2
24 x 6				2
24 x 8				2
24 x 10				2
24 x 12				1
24 x 14				1
24 x 16				1
24 x 18				1
28 x 8			5	1
30 x 4				2
30 x 6	5			2
30 x 8				2
30 x 10			2	1
30 x 12				1
30 x 14				1
30 x 16				1
36 x 6				2
36 x 8				1
36 x 10				1
36 x 12				1
36 x 14				1
36 x 16				1
36 x 18				1
40 x 8				1

300 Series

The 300 series register is the height of both form and function. Each individual curved blade is fully adjustable for total control. The outside frame is slightly beveled, and manufactured without mitered corners. The various configurations of this diffuser include damper choices and throw direction.



Model 301M

Curved Blade - 1 Way



Model 302M

Curved Blade - 2 Way Horizontal

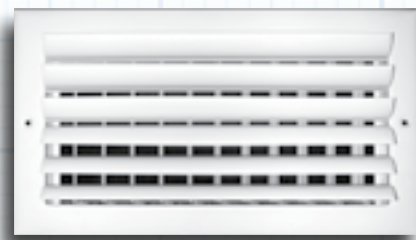

Model 303M

Curved Blade - 3 Way

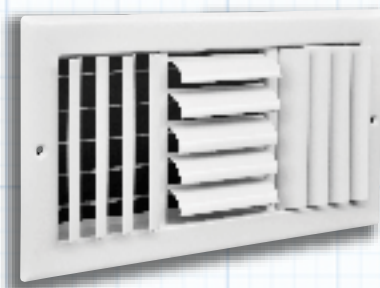

Model 302VM

Curved Blade - 2 Way Vertical

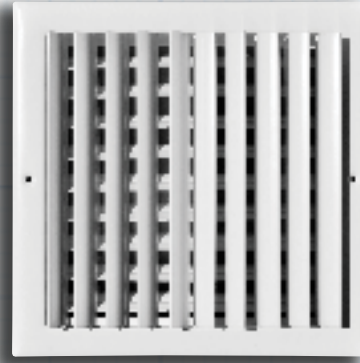

Model 304M

Curved Blade - 4 Way



Compare to: 301M 302M 303M 304M

Hart & Cooley	CHM1	CHM2	CM3	CM4
Shoemaker	CB10M	CB20M	CB30M	CB40M
USAire	--	--	--	--
Continental	SACB1	SACB2	SACB3	SACB4
Lima	291ML	292ML	293ML	294ML
Airmate	401HM	402M	403HM	404M

Features

- Steel construction
- One piece frame (up to 14 x 10)
- Countersunk screw holes
- Unique beveled edges
- Individually adjustable curved blades
- SmoothGlide multi-shutter damper
- Pristine powder coat finish
- Optional opposed blade damper

Product Detail

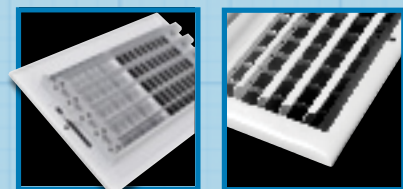

SmoothGlide dampers One Piece Frame without mitered pieces

Available Finishes

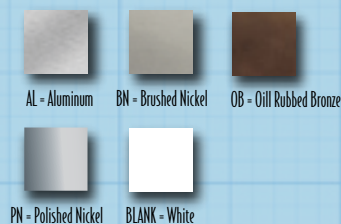

300 SERIES STOCKING SIZES AND CARTON QUANTITY CHART

Register Size (IN)	MODEL													
	301	301-O	301M	301VM	302M	302-O	302-VO	302VM	303F	303-O	303M	304F	304-O	304M
6 x 6		10	20		20	10		20	1	10	20	1	10	20
8 x 4		10	20		20	10		20		10	20		10	20
8 x 6		10	20		20	10	10	20		10	20		10	20
8 x 8		10	10		10			10	1	5	10		5	10
10 x 4			20		20			20		5	20			20
10 x 6	10	5	10		10			10		5	10			10
10 x 8			10					10		5	10			
10 x 10		5	10		10			10	1	5	10	1	5	10
12 x 4			20		20			20			20			
12 x 6	10	5	10		10			10		5	10			10
12 x 8		5	10		10			10		5	10			
12 x 10			10								10			
12 x 12		2	10		10			10	1	2	10		2	10
14 x 4			10		10			10			10			10
14 x 6	10	5	10		10			10		5	10			10
14 x 8		5	10		10			10		5	10			10
14 x 10			10	10	10			10			10			10
14 x 12											5			
14 x 14		2	5					5	1	2	5		2	5
16 x 6	10	5	10							5	10			
16 x 8										2	10			
16 x 10											5			
16 x 16			5		5			5		2	5		1	5
18 x 6	10	5	10											
18 x 18											2		1	2
20 x 6	10		10								10			
20 x 8											10			
20 x 18			5											
20 x 20													1	2
24 x 24													1	2
30 x 6														2

Throw Patterns:

MODEL 301 ONE WAY

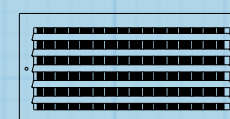

MODEL 302 TWO WAY HORIZONTAL

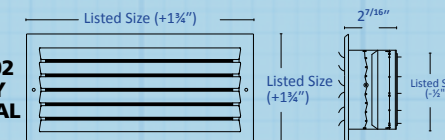

MODEL 302V TWO WAY VERTICAL

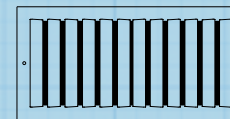

MODEL 303 THREE WAY

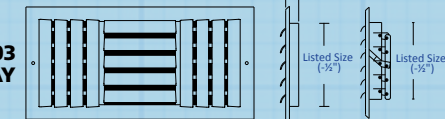

MODEL 304 FOUR WAY

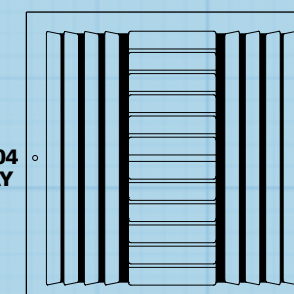

NOTE: All dimensions shown are typical for the 300 Series.

Model 303-O

Three Way - OBD Option

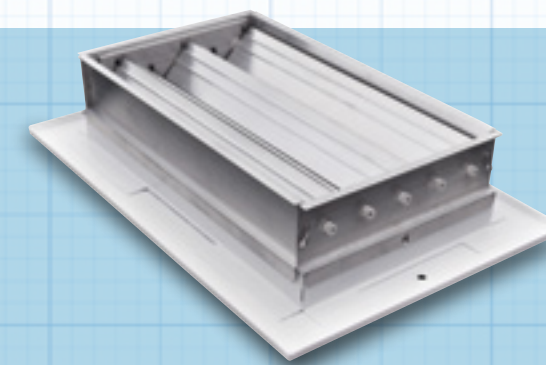

Model Number Specifications

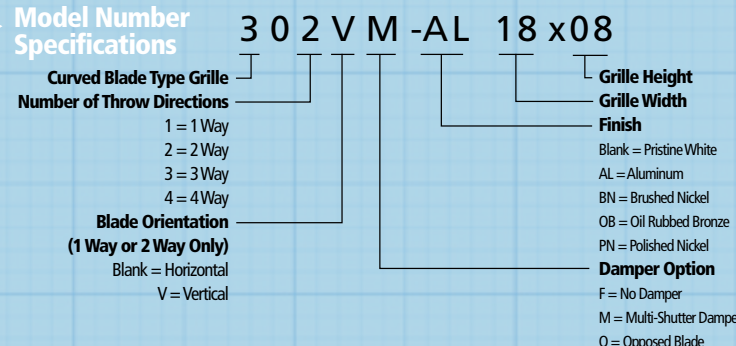

400 Series

TRUaire's 400 series is a stamped steel register at heart, but with a big difference. Unlike the 100 series stamped steel register, the blades on the face of the 400 series are stamped in a curve. This configuration provides a classy look, and a more even air pattern, all with the cost benefit of stamped steel.



Model 401M

Stamped Curved Blade
1 Way Horizontal



Model 402M

Stamped Curved Blade
2 Way Horizontal



Model 402VM

Stamped Curved Blade
2 Way Vertical



Model 403M

Stamped Curved Blade - 3 Way



Model 404M

Curved Blade - 4 Way



Compare to:

	401M	402M	403M	404M
Hart & Cooley	301	302	303	304
Shoemaker	201H	202H	203	204
USAire	1201M	1202M	1203M	1204M
Continental	C1H	C2H	C3H	C4H
Lima	501CB1W	502CB2W	503CB3W	504CB4W
Airmate	601M	602M	603M	604M

Features

- Steel construction
- Countersunk screw holes
- Curved blade face
- SmoothGlide multi-shutter damper
- Pristine powder coat finish

Product Detail



Countersunk Screw Hole & Damper Handle | Stamped Curved Blade Detail

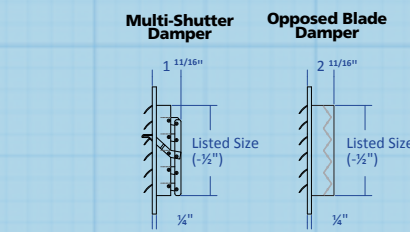

Throw Patterns:

MODEL 401 ONE WAY

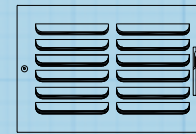

MODEL 402 TWO WAY HORIZONTAL

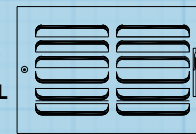

MODEL 402V TWO WAY VERTICAL

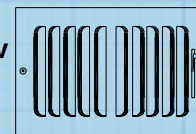

MODEL 403 THREE WAY

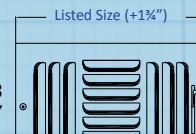

MODEL 404 FOUR WAY

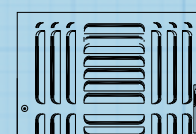

NOTE: All dimensions shown are typical for the 400 Series.

400 Series Options

Model 402M
Stamped Curved Blade
2 Way - Horizontal



Engineered stamped curved blades with pristine powder coat finish and recessed screw holes.

Model 402VM
Stamped Curved Blade
2 Way - Vertical



Model 403M
Stamped Curved Blade
3 Way



TRUaire SmoothGlide

Durable Rivets installed AFTER powder coating for smoothest operation

Blade & linkage components are individually powder coated BEFORE assembly

Model Number Specifications

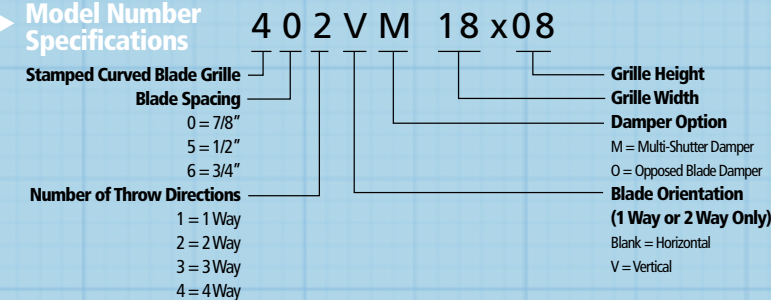

Durable Rivets installed AFTER powder coating for smoothest operation

Blade & linkage components are individually powder coated BEFORE assembly

560 Series

These high capacity diffusers cover a variety of design requirements. Each of these models is available in square sizes only. The blade design is unusually wide specifically for allowing large volumes of air to move through them. The 600 and 700 Series are primarily used for evaporative cooler, or make-up air applications.



Model 560M

Square Ceiling Directional Diffuser

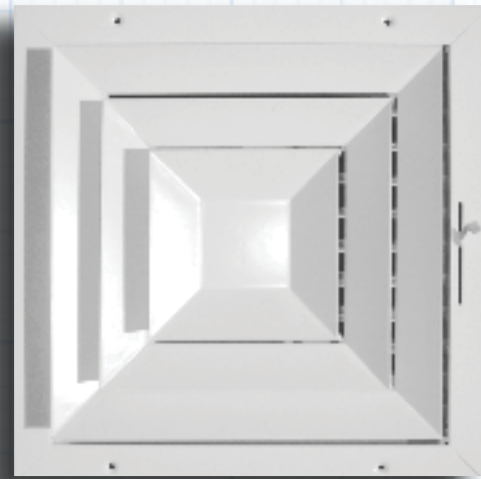

Model 560 - No Damper

Square Ceiling Directional Diffuser



Profile view shown without damper

Compare to:

	560	600	700
Hart & Cooley	ESSD/D	ECBX	ECHVD
Shoemaker	--	--	450
US Aire	--	--	--
Continental	--	--	--
Lima	1103/2	1150	1170
Airmate	1020/30	100	1200

Features

- Steel construction
- Countersunk screw holes
- Multi-shutter damper
- Pristine white powder coat finish

Product Detail



Multi-Tier Diffusion (Model 560M shown)

560 Series Options

Model 560M

Reverse side shown with damper

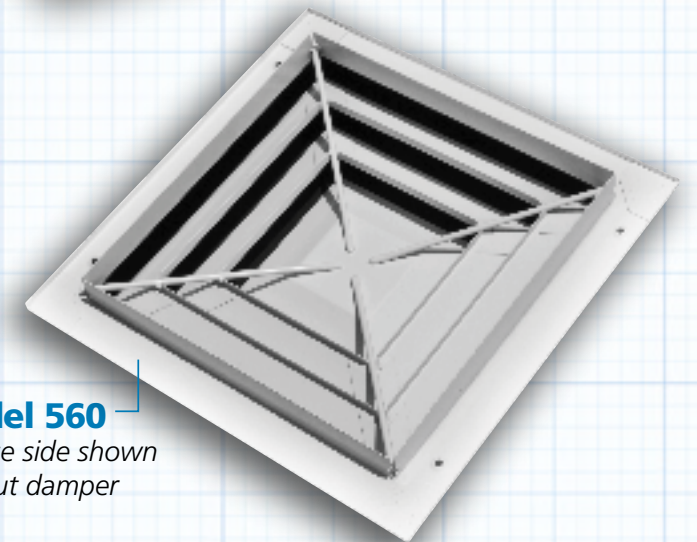
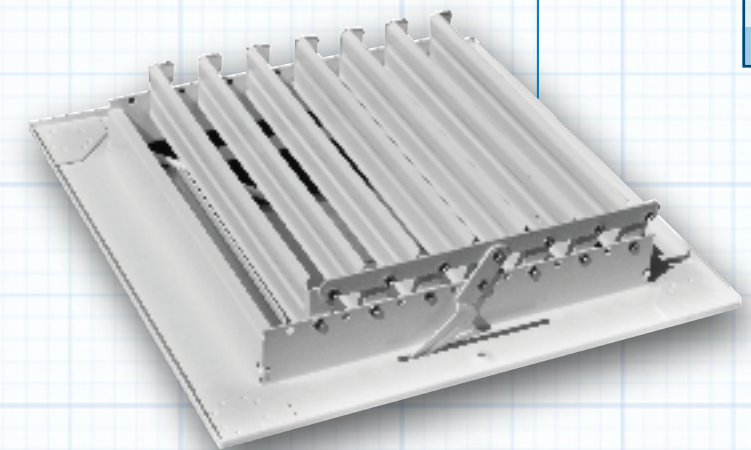

Model 560

Reverse side shown without damper

Model 560

	560	560M
6 x 6	20	20
8 x 8	20	20
10 x 10	20	10
12 x 12	10	10
14 x 14	10	10
16 x 16	5	5
18 x 18	2	2
20 x 20	2	2

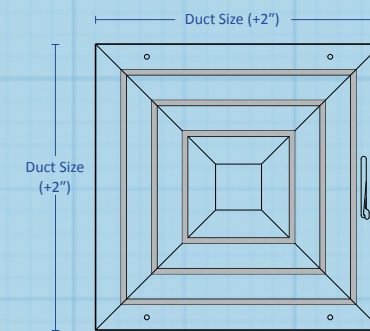
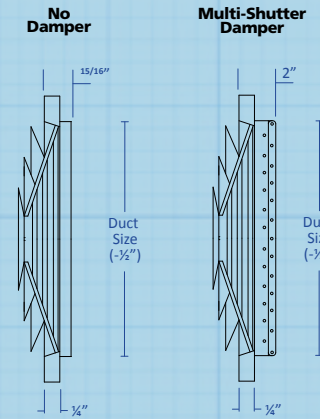

Model Number Specifications

560M 16 x 16

High Capacity Direction Diffuser Grille Height
 Damper Option Grille Width

Blank = No Damper
 M = Multi-Shutter Damper

TRUaire SmoothGlide™

Durable Rivets installed AFTER powder coating for smoothest operation

Blade & linkage components are individually powder coated BEFORE assembly

600 Series

These high capacity diffusers cover a variety of design requirements. Each of these models is available in square sizes only. The blade design is unusually wide specifically for allowing large volumes of air to move through them. The 600 Series are primarily used for evaporative cooler, or make-up air applications.



Model 600

Evaporative Cooler
Make-up Air Diffuser

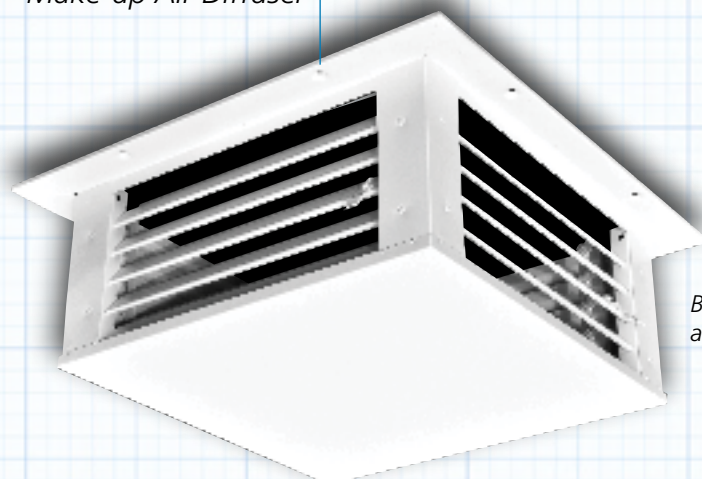

Blade design allows for maximum air flow

*Available in white or stainless steel finish

Model 600MSS

Stainless Steel
Evaporative Cooler
Make-up Air Diffuser



Compare to: 600

Hart & Cooley	ECBX
Shoemaker	--
US Aire	--
Continental	--
Lima	1150
Airmate	100

Features

- Steel construction
- Optional stainless steel
- Countersunk screw holes
- Multi-shutter damper
- Pristine white powder coat finish

Available Finishes



Product Detail



High capacity blade design

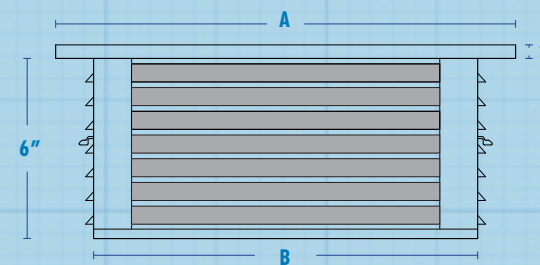

600 Series Dimensions

SIZE	A	B
10 X 10	13"	10 1/4"
12 X 12	15"	12 1/4"
14 X 14	17"	14 1/4"
16 X 16	19"	16 1/4"
18 X 18	21"	18 1/4"
20 X 20	23"	20 1/4"
22 X 22	25"	22 1/4"
22 X 22T	23 3/4"	21"
24 X 24	27"	24 1/4"
26 X 26	29"	26 1/4"
30 X 30	33"	30 1/4"
32 X 32	35"	32 1/4"

NOTE: This size is available for 24"x 24" T-Bar Lay-in model number 600 22 x 22T

600 Series Options

Model 600

Pristine White
Powder Coat

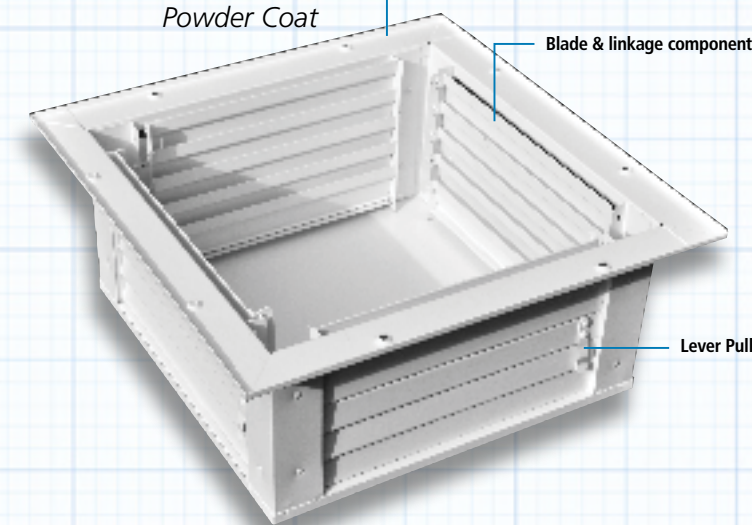

Shown Open



Shown Closed

Model Number Specifications

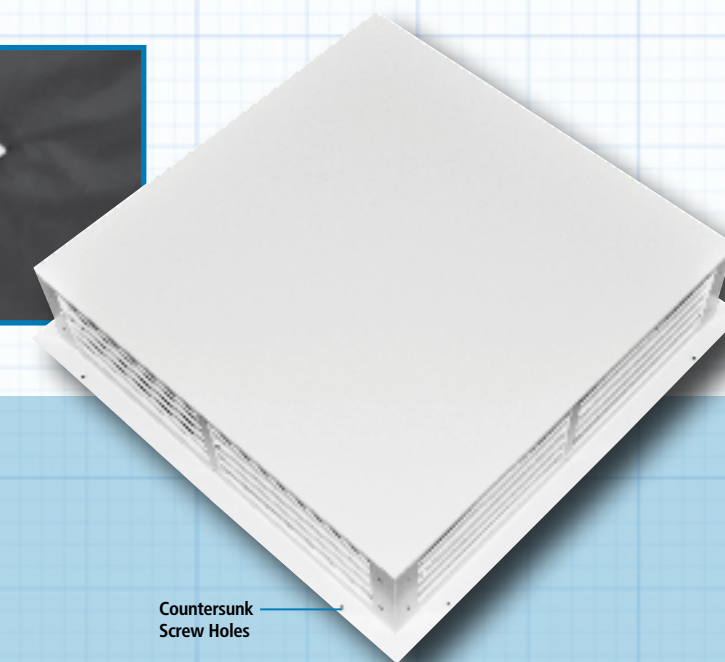
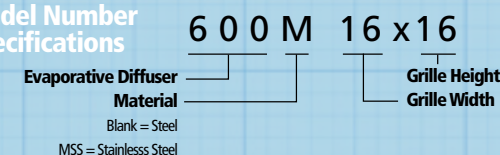

Countersunk Screw Holes

700 Series

These high velocity diffusers cover a variety of design requirements. Each of these models is available in square sizes only. The blade design is unusually wide specifically for allowing large volumes of air to move through them. The 700 Series are primarily used for evaporative cooler, or make-up air applications.

Model 700

High Velocity
Flush Mount Diffuser



Blades shown in OPEN position



Compare to: 700

Hart & Cooley	ECHVD
Shoemaker	450
US Aire	--
Continental	--
Lima	1170
Airmate	1200

Features

- Steel construction
- Countersunk screw holes
- Multi-shutter damper
- Pristine white powder coat finish

Product Detail



High capacity blade design

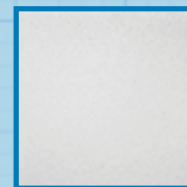

Pristine White Powder Coat Finish

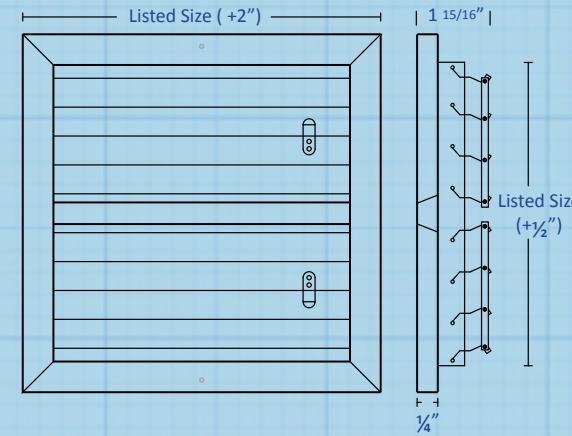

Lever Pull

Lever Pull



Shown Open

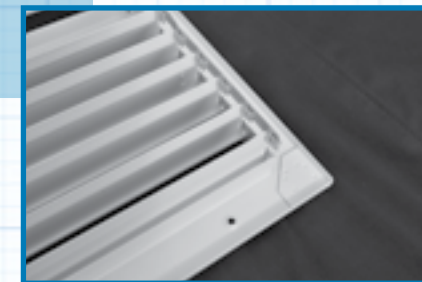

Shown Closed

700 Series Options

Model 700M

Pristine White
Powder Coat

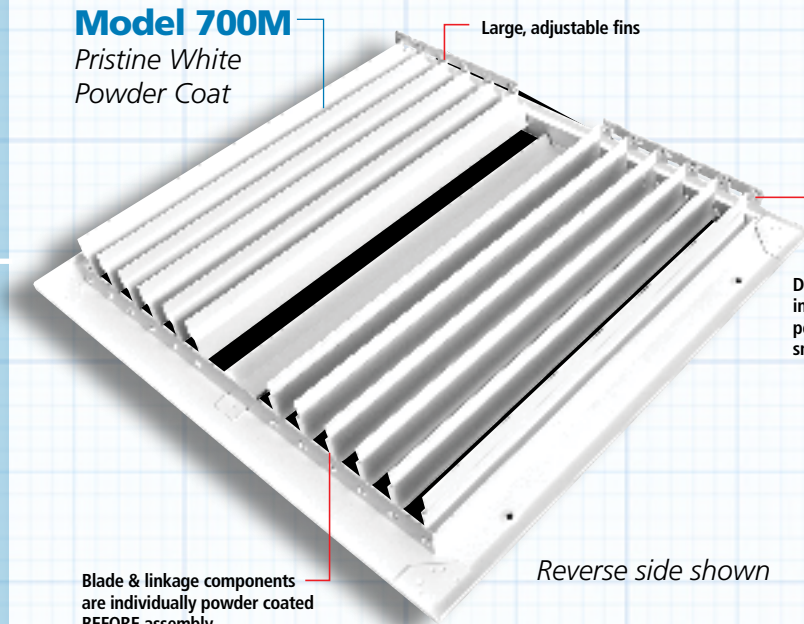

Large, adjustable fins

Durable Rivets installed AFTER powder coating for smoothest operation

Blade & linkage components are individually powder coated BEFORE assembly

Reverse side shown

Model 700M

Shown in Closed Position

Countersunk Screw Holes



Rugged Steel Construction

700 Series	
FLUSH MOUNT	
6 x 6	10
8 x 8	10
10 x 10	10
12 x 12	10
14 x 14	10
16 x 16	5
18 x 18	5
20 x 20	5
22 x 22	5
24 x 24	5

Model Number Specifications
 700 16 x 16
 Stamped Louver Type Grille Grille Height Grille Width

800 Series

Simple, versatile, easy to operate, and easy to install. The 800 Series register face is the same pristine white powder-coat we use on everything we make. There are two different damper configurations to choose from, and both of them work with our ceiling mounted diffusers.

Model 800 Register Face



Model 801 Butterfly damper & installation ring



Model 803 Installation ring only

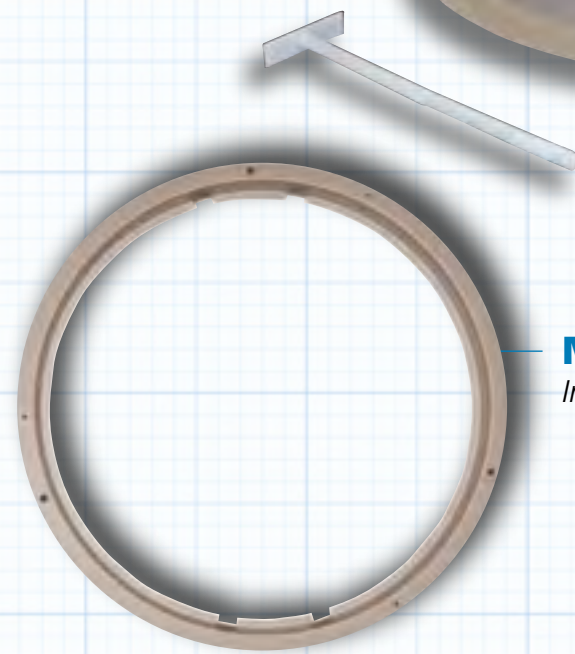

Compare to:

800
Hart & Cooley 16
Shoemaker 90
USAire 900
Continental 16
Lima 150
Airmate 800

Features

- Steel construction
- Countersunk screw holes
- Pristine white powder coat finish
- Optional butterfly damper
- Optional radial damper

Product Detail

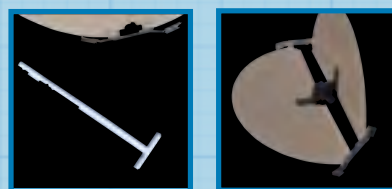

Operating Handle Butterfly Damper

Sizes & Carton Quantity Chart

SIZE	800	801	803
6	20	20	20
8	20	20	20
10	20	20	20
12	20	20	20
14	10	10	10
16	10	10	10
18	10	10	10

800 Series Options

Register manufacturers have never done a good job of explaining how different round ceiling diffusers and dampers work together. The illustration below will demonstrate a couple of the more commonly used installation configurations for you to choose from.

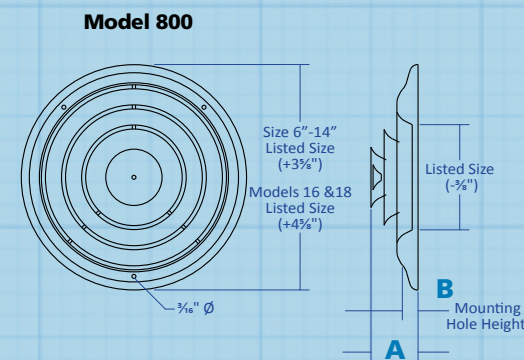

800 Series Dimensions

SIZE	A	B
6"	1 1/8"	7/16"
8"	1 1/8"	7/16"
10"	1 1/8"	7/16"
12"	1 1/4"	7/16"
14"	1 3/8"	7/16"
16"	1 5/8"	1/2"
18"	2"	1/2"

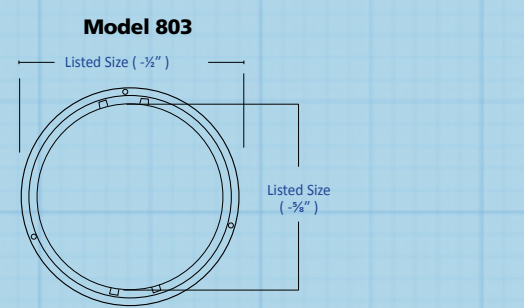
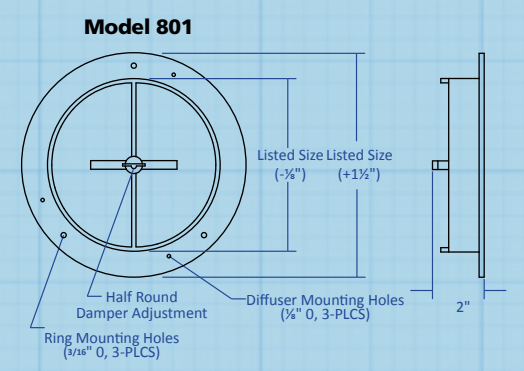

Model Number Specifications

8	0	3	10	Nominal Duct Diameter
Round Ceiling Diffusers				06 = 6"Ø
Surface Mount				08 = 8"Ø
Damper & Mounting Ring Options				10 = 10"Ø
0 = Round Diffuser				12 = 12"Ø
1 = Damper & Mounting Ring				14 = 14"Ø
3 = Mounting Ring				16 = 16"Ø
				18 = 18"Ø

Model 801



Model 800



There are two different installation rings to choose from. The Model 801 installation ring includes a round butterfly damper. The damper can be opened and closed using the plastic "T" handle that is provided.

A typical installation of round registers requires the register face, and a mounting ring. The ring will be attached to the drywall or sheet rock, and then the register can be installed on the ring.

Model 803



B

Model 800

The other installation ring, Model 803, is used for installations where no damper is going to be required.

880 Series

The 880 Series Round Commercial Diffusers are step-down ringed diffusers which are used to cover duct openings. Our product is constructed to ensure maximum airflow and the simple design will ensure that this duct diffuser streams air directly into your room. Made of high quality steel with a white powder coat finish each of our step down diffuser rings deflect the air stream 360 degrees.

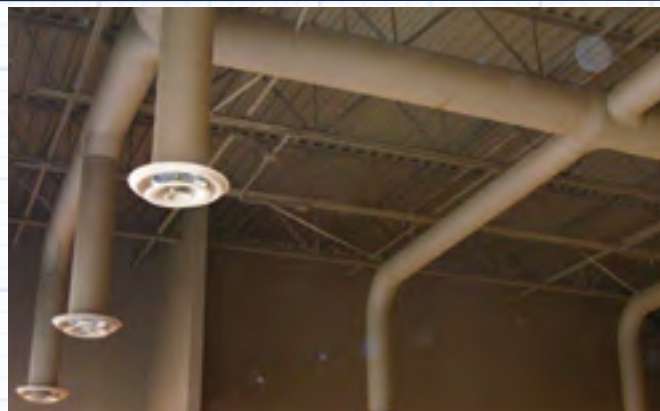

Model 880

Round Commercial Diffuser

PROFILE VIEW

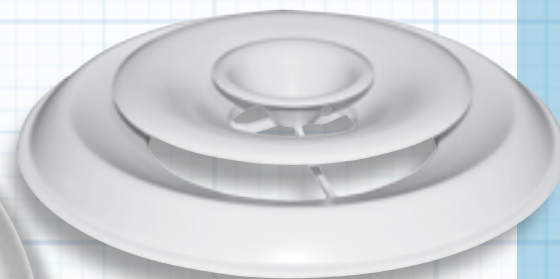

FRONT SIDE

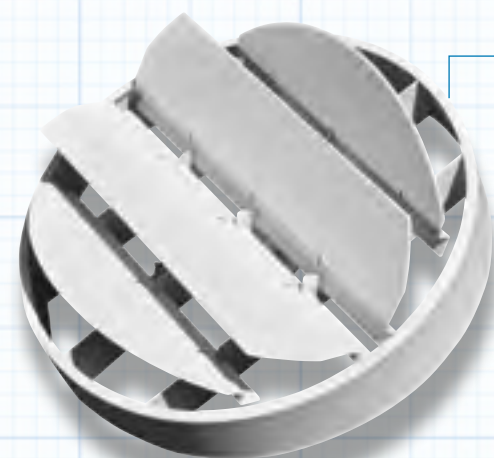

Model 881

Round Opposed Blade Damper

Model 883

Round Surface Mount Ring

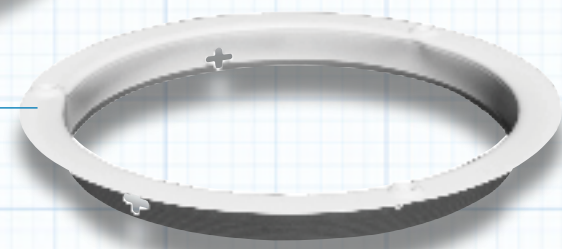

Features

- Steel construction
- 3 Cones
- Uniform 360° airflow pattern
- Removable center core
- Pristine white powder coat finish
- Optional surface mount ring
- Optional opposed blade damper

Product Detail



3 Tier Step-Down



Durable Louvered Design



360-degree pattern, horizontal to vertical pattern change

880 / 881 / 883 Stocking Sizes & Carton Quantity Chart

GRILLE DIAMETER	MODEL		
	880	881	883
6"	10	10	20
8"	5	10	20
10"	5	10	20
12"	1	10	10
14"	1	10	10
16"	1	5	10
18"	1	5	10

880 Series Options

Register manufacturers have never done a good job of explaining how different round ceiling diffusers and dampers work together. The illustration below will demonstrate a couple of the more commonly used installation configurations available for you to choose from.

Model 880

REVERSE SIDE

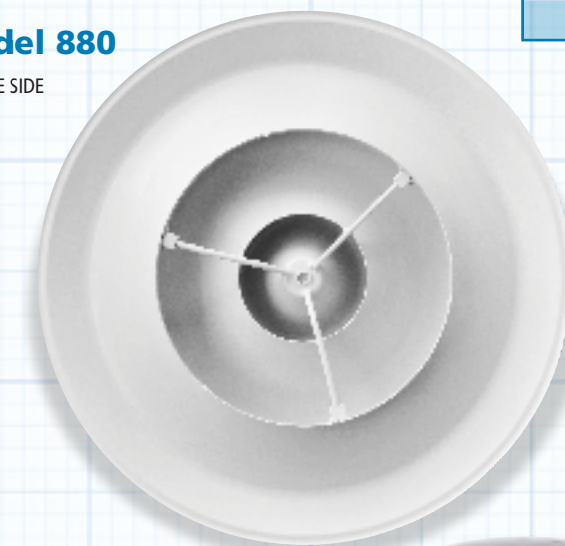

Model 881

REVERSE SIDE

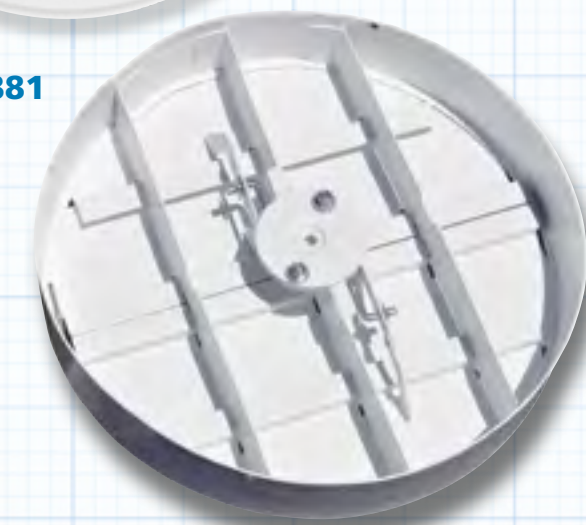

Model 883

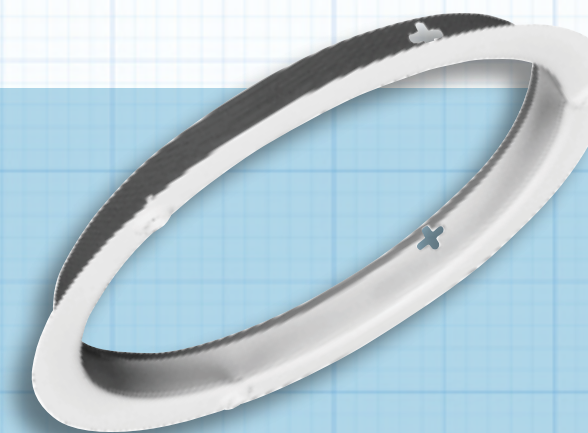

Model 880

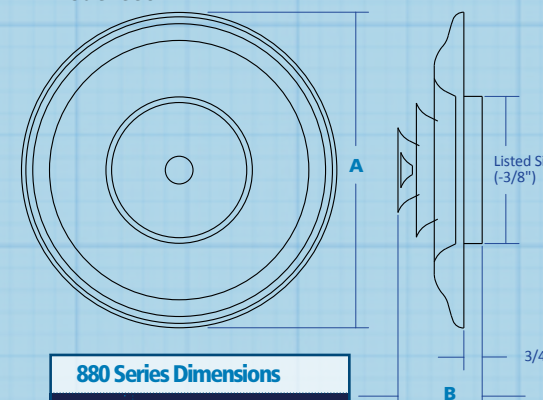

880 Series Dimensions		
SIZE	A	B
6"	11 1/4"	2 1/2"
8"	14 3/4"	2 1/2"
10"	18 1/2"	2 1/2"
12"	22"	3 3/8"
14"	25 1/4"	4"
16"	28 3/4"	4 3/8"
18"	32 1/4"	4 3/4"

Model 881

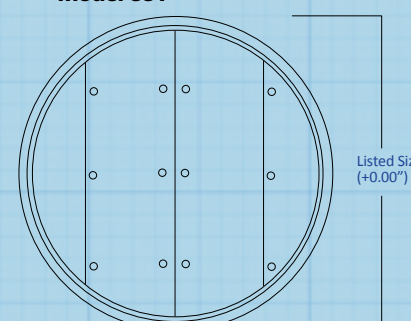

Model 883

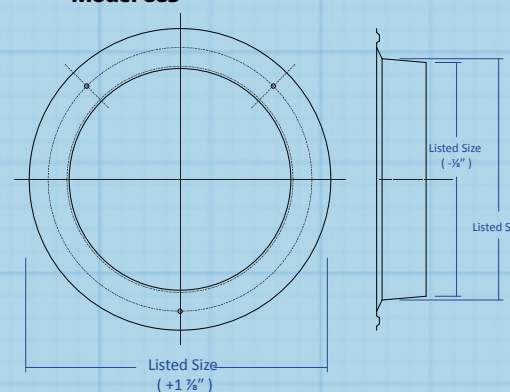

Model Number Specifications

883-10

Round Ceiling Diffuser
Duct Mount
Damper & Mounting Ring Options

- 0 = Round Duct Diffuser
- 1 = Opposed Blade Damper
- 3 = Mounting Mounting Ring

Nominal Duct Diameter

- 06 = 6"Ø
- 08 = 8"Ø
- 10 = 10"Ø
- 12 = 12"Ø
- 14 = 14"Ø
- 16 = 16"Ø
- 18 = 18"Ø

A210 Series - Aluminum

Among the most versatile of all supply registers, the A210 Series Single Deflection register is available in a wide variety of configurations for almost any application. These registers feature an attractive and highly effective open blade design which allows increased airflow when compared to any stamped fin design. The single row of adjustable airfoil designed blades can be oriented horizontally or vertically.

Whether ceiling or sidewall, commercial or residential, these register delivers high capacity airflow, style & solid construction.

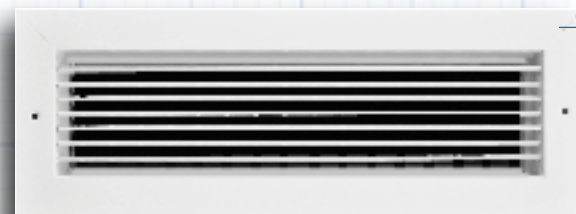

Model A210H
Adjustable Horizontal Blades
No Damper

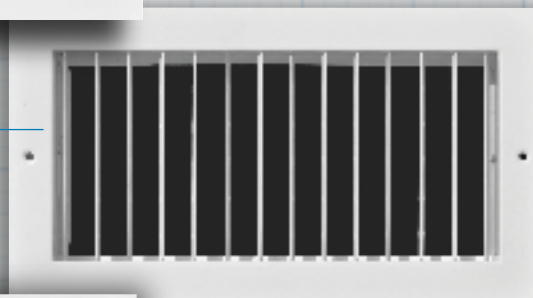

Model A210V
Adjustable Vertical Blades
No Damper



Model A210VM
Adjustable Vertical Blades
SmoothGlide Multi-Shutter Damper



Model A210HO
Adjustable Horizontal Blades
Opposed Blade Damper



Model A210VO
Adjustable Vertical Blades
Opposed Blade Damper

Compare to:	A210VM	A210VO
Hart & Cooley	A618MS	A618OB
Shoemaker	950	950-O
USAire	VM	VD
Continental	AVM	X
Lima	AL900V	AL990VOBD
Airmate	A420-VM	AT420-VO

Features

- Aluminum construction
- One piece frame (up to 14 x 10)
- 3/4" blade spacing
- Countersunk screw holes
- Individually adjustable horizontal or vertical airfoil blades
- Pristine white powder coat finish
- Optional SmoothGlide multi-shutter damper
- Optional opposed blade damper

Product Detail

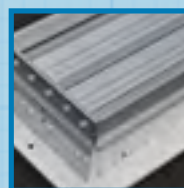

Durable Nylon Bushings

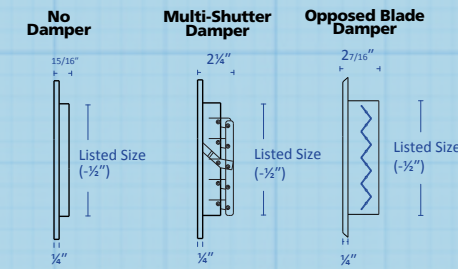

MODEL A210H

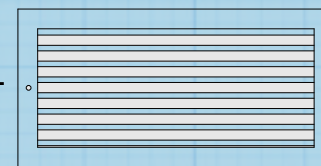

MODEL A210V

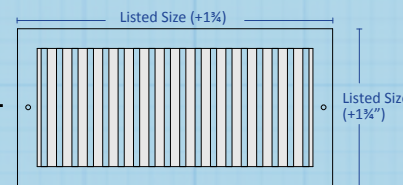

NOTE: All dimensions shown are typical for the A210 Series.

A210 Series Options

Opposed Blade Damper (OBD)

Top notch craftsmanship includes nylon bushings to ensure the aluminum blades stay in place according to the airflow requirements.

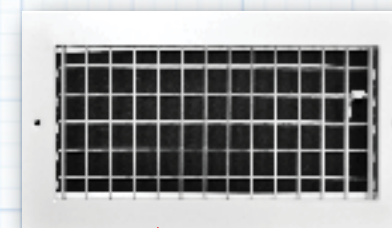
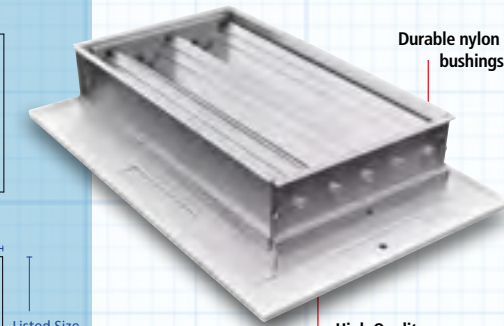

Model A210VM
Detail showing 12"x 06" size with vertical blades and multi-shutter damper

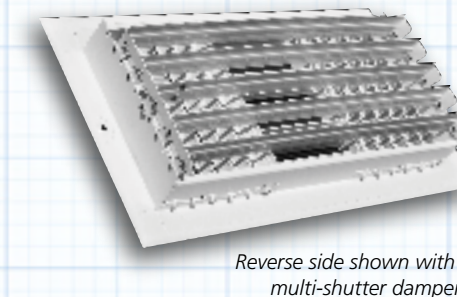

Reverse side shown with multi-shutter damper

A210 SERIES STOCKING SIZES AND CARTON QTY CHART

Register Size (IN)	MODEL					
	A210H	A210HM	A210HO	A210V	A210VM	A210VO
6 x 4					20	
6 x 6	10				20	10
8 x 4	20		10		20	10
8 x 5					20	
8 x 6					20	10
8 x 8	5				20	5
10 x 4				20	20	
10 x 5					20	
10 x 6	20		5	20	20	20
10 x 8	20		5	20	20	5
10 x 10					10	5
12 x 4	20			20	20	
12 x 5					20	
12 x 6	20		5	20	20	5
12 x 8	10		10	10	10	5
12 x 10					10	5
12 x 12				10	12	2
14 x 4	20		5		20	
14 x 5					10	
14 x 6	10		5	10	10	5
14 x 8	10		5	10	10	5
14 x 10				10	10	2
14 x 12					10	
14 x 14				5	5	2
16 x 4					10	2
16 x 5					10	
16 x 6	10		5	10	10	5
16 x 8				10	10	2
16 x 10				5	10	
16 x 16	5		2		5	
18 x 4					10	5
18 x 6	10		5	10	10	5
18 x 8				5	10	5
18 x 10				5	10	
18 x 12					5	
20 x 4					10	
20 x 6				10	10	2
20 x 8				5	5	
20 x 10					5	5
20 x 12					5	
20 x 18					5	
20 x 20					5	
24 x 4					10	
24 x 6	10		2	5	5	2
24 x 8				5	5	2
24 x 10					5	
24 x 12					5	
24 x 14	5			5		
30 x 6	5		2		5	2
30 x 8						2
32 x 4						2
36 x 4						2

Model Number Specifications

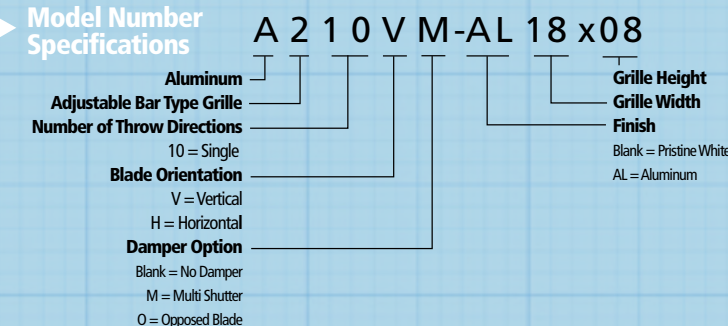

A220 SERIES - Aluminum

TRUaire's A220 Series Double-Deflection registers represent the top-of-the line adjustable bar-type product. These registers feature two perpendicular rows of individually adjustable airfoil blades for maximum airflow control. They can be ordered with the horizontal row in front, (A220H), or with the vertical row in front, (A220V).

Whether commercial or residential, using an opposed blade damper or no damper at all, the A220 Series register delivers high capacity airflow with a sleek aesthetic style and rock solid construction.



Model A220H
Adjustable
Horizontal Blades
No Damper



Model A220V
Adjustable Vertical Blades
No Damper

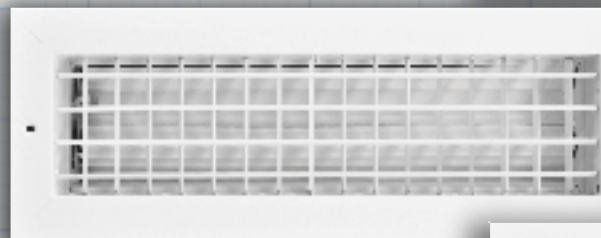

Model A220HO
Adjustable
Horizontal Blades in front
Opposed Blade Damper

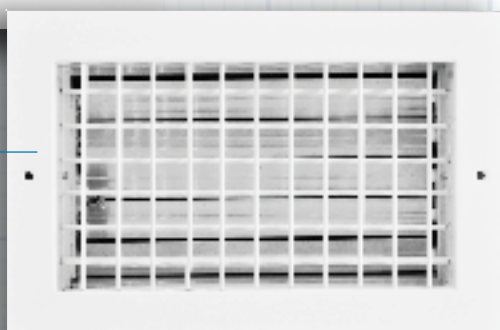

Model A220VO
Adjustable
Vertical Blades in front
Opposed Blade Damper

NOTE: Also available in steel.
See the 220 Series

Compare to:

	A220V	A220VO
Hart & Cooley	--	--
Shoemaker	904	904-O
USAire	VH	VHD
Continental	--	--
Lima	AL990V	AL990VOBD
Airmate	E240V	E240VO

Features

- Aluminum construction
- One piece frame (up to 14 x 10)
- 3/4" blade spacing
- Countersunk screw holes
- Individually adjustable horizontal or vertical airfoil blades
- Pristine white powder coat finish
- Optional opposed blade damper

Product Detail



Square Corners



Nylon Bushings add tension to damper blades

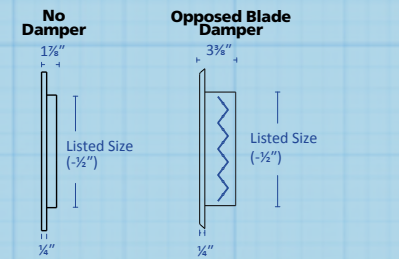

NOTE: All dimensions shown are typical for the A220 Series.

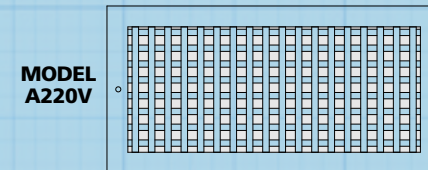

Available in pristine white powder coat or aluminum finish

A220 Series Options

Opposed Blade Damper (OBD)

Top notch craftsmanship includes nylon bushings to ensure the aluminum blades stay in place according to the airflow requirements.

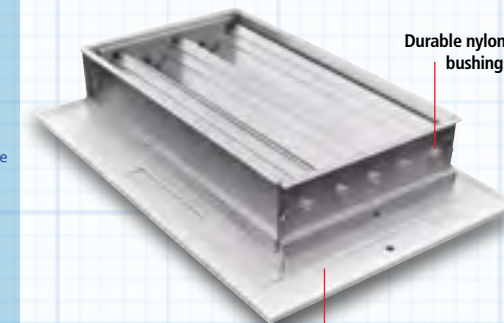

Durable nylon bushings
High Quality Aluminum Components

Model A220HO
Reverse side shown

Standard Configuration

Two perpendicular rows of individually adjustable aluminum blades.

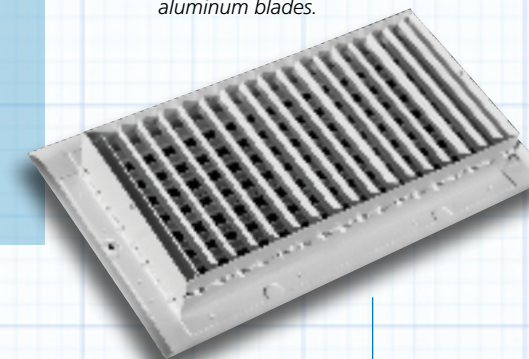

Model A220H
Reverse side shown

Easily adjust aluminum blades to preferred air deflection.

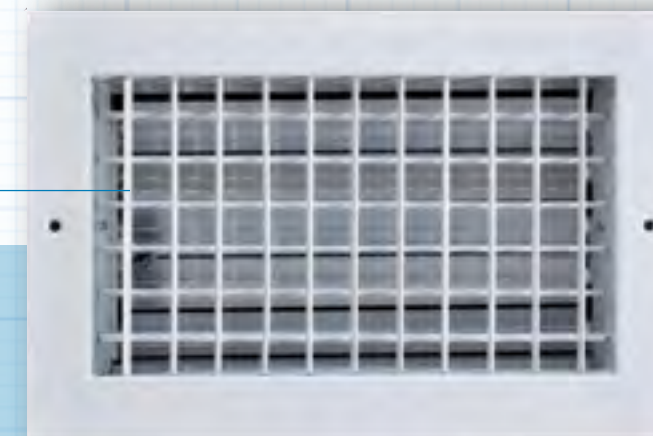

A220 SERIES STOCKING SIZES AND CARTON QTY CHART

Register Size (IN)	MODEL			
	A220H	A220HO	A220V	A220VO
6 x 4				10
6 x 6				10
8 x 4	20	10	20	10
8 x 6				10
8 x 8				5
10 x 4			10	5
10 x 6	20	5	5	5
10 x 8	10	5	5	5
10 x 10				5
12 x 4	10	10	10	10
12 x 6	20	5	10	10
12 x 8	10	5	10	5
12 x 10			20	5
12 x 12				2
14 x 4	10	5		
14 x 6	10	5	10	5
14 x 8	10	5	10	5
14 x 10			2	2
14 x 14				2
16 x 6	10	5	10	5
16 x 8			10	2
16 x 10			10	
16 x 16	5	2		2
16 x 20			5	2
18 x 4			10	5
18 x 6	10	5	10	5
18 x 8			5	2
18 x 10			5	
20 x 6				2
20 x 8			10	2
24 x 4	2			
24 x 6	10	2	10	2
24 x 8			10	2
24 x 10				
24 x 12				
24 x 14	5	2		2
30 x 4			5	2
30 x 6	5	2	2	2
30 x 8				1
30 x 16				2
32 x 8	5			
36 x 6				2

Model Number Specifications

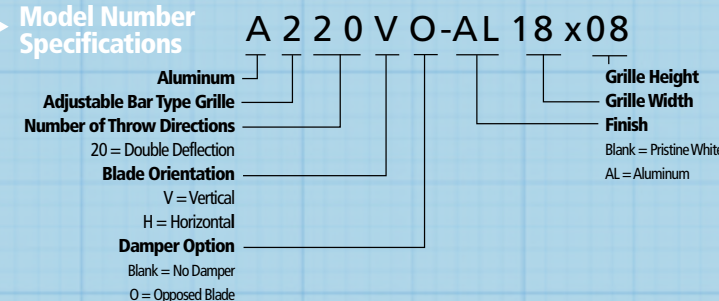

A300 Series - Aluminum

Truair's A300 series diffusers are the best of the best. Individually adjustable curved blades combined with 5 different face patterns provide the ultimate in air control. These sleek diffusers are made of aluminum so they are light-weight and will not rust. You can even add the extra control of our high-quality opposed blade damper.



Model A301HM

Curved Blade - 1 Way

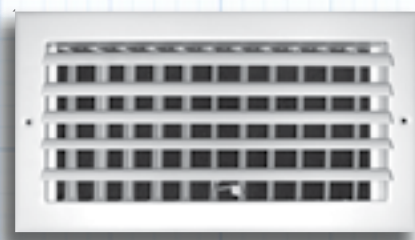

Model A302M

Curved Blade - 2 Way Horizontal



Model A302VM

Curved Blade - 2 Way Vertical



Model A303M

Curved Blade - 3 Way

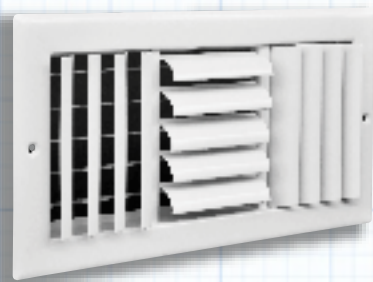

Model A304M

Curved Blade - 4 Way



Compare to: A301M A301O A302M A302O

Hart & Cooley	A611MS	A611OB	A612MS	A612OB
Shoemaker	CB10HM	--	CB20HM	--
USAire	LM/LMH	LD	LTM	LTD
Continental	AACB1	--	AACB2	--
Lima	A271ML	--	AL272ML	--
Airmate	A451HM	AT451HO	A452HM	AT452HO

Compare to: A303M A303O A304M A304O

Hart & Cooley	A613MS	A613OB	A614MS	A614OB
Shoemaker	CB30HM	--	CB40HM	--
USAire	LSM3	LSD3	LS4M	LS4D
Continental	AACB3	--	AACB4	--
Lima	AL273ML	--	AL274ML	--
Airmate	A453HM	AT453HO	A454HM	AT454HO

Features

- Aluminum construction
- One piece frame (up to 14 x 10)
- Countersunk screw holes
- Individually adjustable curved blades
- Optional SmoothGlide multi-shutter damper
- Pristine white powder coat finish
- Optional opposed blade damper

Product Detail

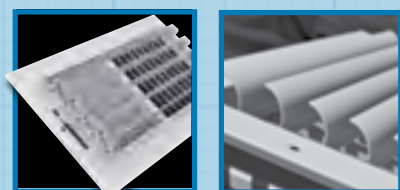

SmoothGlide dampers Large, adjustable blades

A300 SERIES STOCKING SIZES AND CARTON QUANTITY CHART

Register Size (IN)	MODEL													
	A301HO	A301HM	A301MG	A302M	A302MG	A302VO	A302VM	A303F	A303-O	A303M	A304F	A304-O	A304M	
4 x 4		20												
6 x 4		20	20	20										
6 x 6	10	20		20				20	10	20	20	10	20	
6 x 10		10												
8 x 4	10	20	20	20			20		10	20				
8 x 6	5	20	20	20						20				
8 x 8	1	10	20	10			10	10	5	10	10	5	10	
10 x 4		20		20						10				
10 x 6	5	10	10	10	10	10	10		5	10				
10 x 8	5	10	10	10			10			10				
10 x 10	5	10	10	10	10		10	10	5	10	10	5	10	
12 x 4		20		10										
12 x 6	5	10	10	10	10		10		5	10				
12 x 8	5	10	10	10	10	10	10		5	10				
12 x 10		10		10										
12 x 12	2	10	10	10			10	10	2	10	10	2	10	
14 x 4		10		10										
14 x 6	10	10	10	10	10		10		5	10				
14 x 8	5	10	10	10			10			10				
14 x 10		10		10										
14 x 12		10												
14 x 14		10		10					5	2		10	2	10
16 x 4		10												
16 x 6	5	10												
16 x 8		10												
16 x 10														
16 x 16		5								5		1	5	
18 x 6														
18 x 18		2										1	2	
20 x 6														
20 x 8		10												
20 x 10		10												
20 x 18														
20 x 20												1		
24 x 24														
30 x 6														

Throw Patterns:

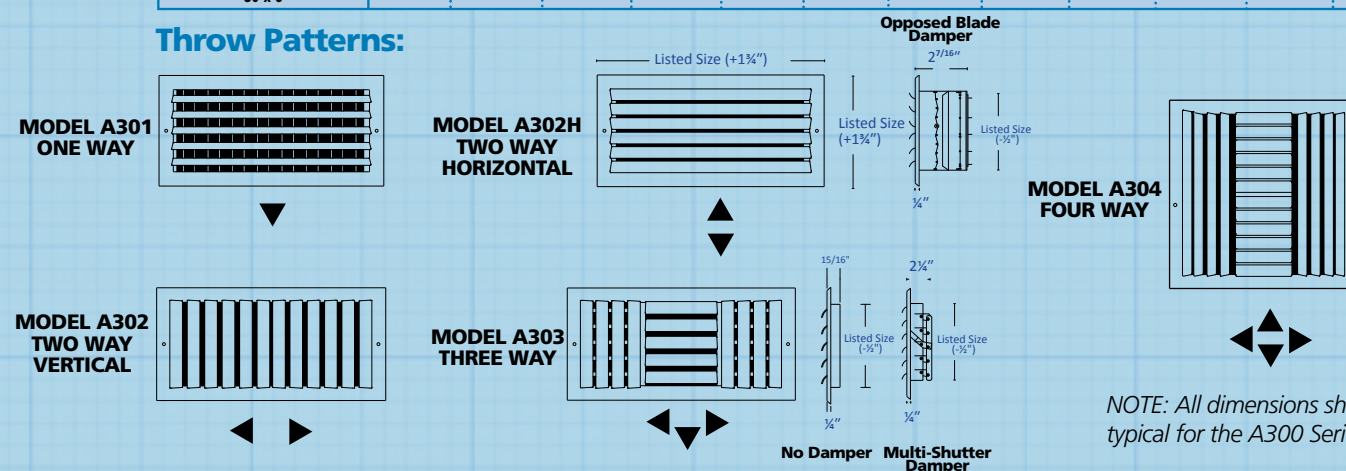

NOTE: All dimensions shown are typical for the A300 Series.

Model Number Specifications

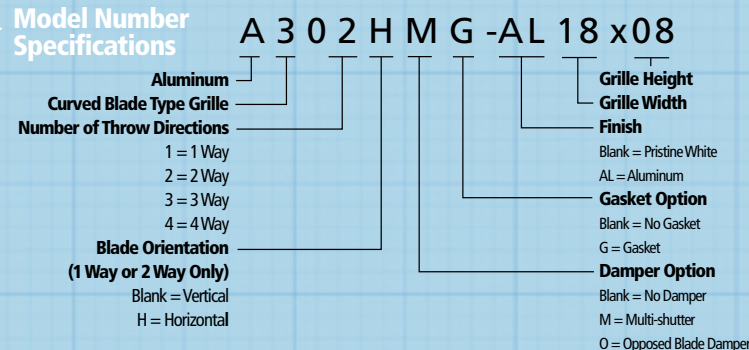

A300MG with Gasket

Available in 1, 2, and 4 way air throw configurations.

Foam gasket

A400 SERIES

TRUaire's A400 series is a stamped aluminum register at heart but with a big difference. Unlike the 100 series stamped steel register, the blades on the face of the A400 series are stamped in a curve. This configuration provides a classy look, and a more even air pattern, all with the cost benefit of stamped steel.



Model A401M

Stamped Curved Blade
1 Way Horizontal



Model A402M

Stamped Curved Blade
2 Way Horizontal



Model A402VM

Stamped Curved Blade
2 Way Vertical



Model A403M

Stamped Curved Blade - 3 Way



Model A404M

Curved Blade - 4 Way



Compare to: A401M A402M A403M A404M

Hart & Cooley	301	302	303	304
Shoemaker	201H	202H	203	204
USAire	1201M	1202M	1203M	1204M
Continental	C1H	C2H	C3H	C4H
Lima	501CB1W	502CB2W	503CB3W	504CB4W
Airmate	601M	602M	603M	604M

Features

- Aluminum construction
- Countersunk screw holes
- Curved blade face
- SmoothGlide multi-shutter damper
- Pristine powder coat finish

Product Detail



Detail View of Damper Latch

Stamped Curved Blade Detail

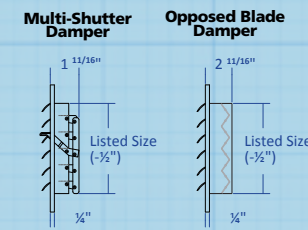

Throw Patterns:

MODEL A401 ONE WAY



MODEL A402H TWO WAY HORIZONTAL

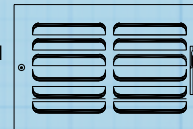

MODEL A402 TWO WAY VERTICAL



MODEL A403 THREE WAY

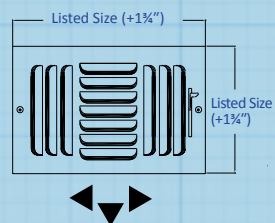

MODEL A404 FOUR WAY

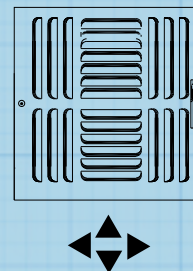

NOTE: All dimensions shown are typical for the A400 Series.

Model Number Specifications

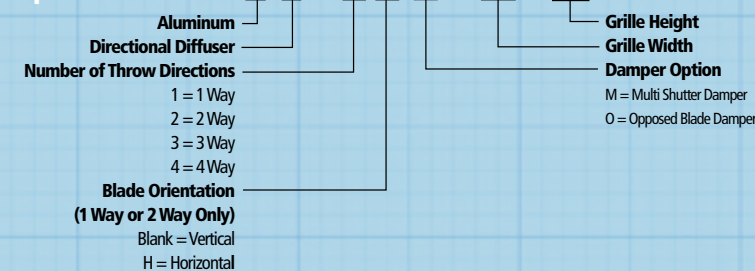

A400 Series Options

SmoothGlide Damper

SmoothGlide Technology is the very simple, albeit very expensive, process of carefully powder-coating each and every individual component of a register, prior to assembly. The finished product is a stamped steel register with 100% powder coat coverage and a smooth quiet damper assembly that glides open or closed with the touch of a finger.

Model A402M

Stamped Curved Blade
2 Way - Horizontal



Engineered stamped curved blades with pristine powder coat finish and countersunk screw holes.

Model A402VM

Stamped Curved Blade
2 Way - Vertical

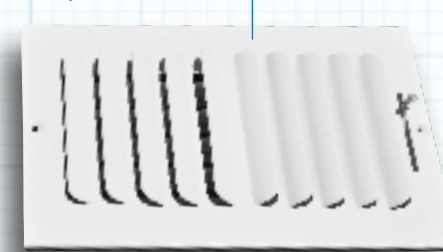

Model A403M

Stamped Curved Blade
3 Way



TRUaire SmoothGlide

Durable Rivets installed AFTER powder coating for smoothest operation

Blade & linkage components are individually powder coated BEFORE assembly

A400 Series Stacking Sizes & Carton Quantity Chart

SIZE	A401M	A403M	A404M
6 X 6	20		
8 X 4	20	20	20
8 X 6	20	20	
10 X 6	20	20	
10 X 8	20	20	20
10 X 10	20	20	20
12 X 6	20	20	
12 X 8	20	20	20
12 X 12	20	20	
14 X 6	20	20	20

A500 Series - Aluminum

The A500 Series represents a great blend of form and function. The extruded aluminum blade and frame design is sleek and finished with our pristine white powder-coat process. The mitered corners are clean to the point of barely a notice.

At the same time, the durability of extruded aluminum won't rust and the sturdy frame and blade design come together for a lifetime of use. The A500 Series is available in a variety of airflow configurations and two different damper designs. Altogether then, this diffuser is as flexible as it is attractive.



Model A501M

Ceiling Diffuser - 1 Way



Model A503M

Ceiling Diffuser - 3 Way



Model A505M

Ceiling Diffuser - 2 Way Corner

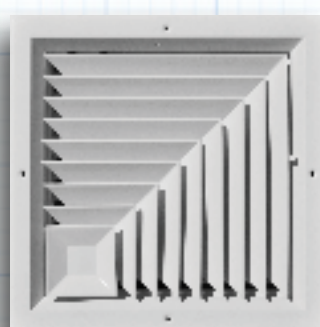

Model A502M

Ceiling Diffuser - 2 Way



Model A504M

Ceiling Diffuser - 4 Way



Compare to:	A500M	A500-O
Hart & Cooley	A500MS	A500-OB
Shoemaker	SDD	SDD-O
USAire	5200	5200-DA
Continental	AE-MS	AE-OB
Lima	AL160ML	AL160OBD
Airmate	E105M	E105-O

Features

- Extruded aluminum construction
- Mitered corners
- Countersunk screw holes
- 5 air patterns
- SmoothGlide multi-shutter damper
- Pristine white powder coat finish
- Optional opposed blade damper

Product Detail



Mitered Frame Corner

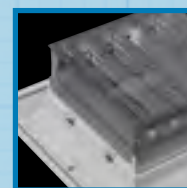

Optional OBD Damper

Throw Patterns:

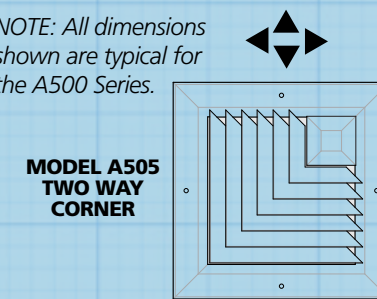
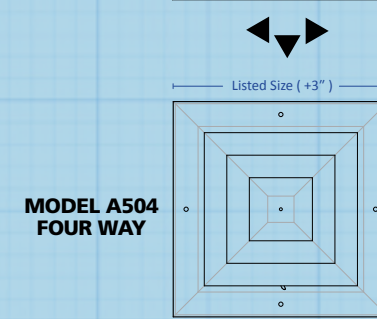
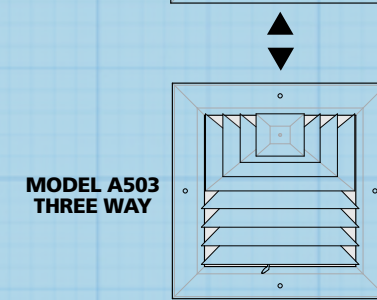
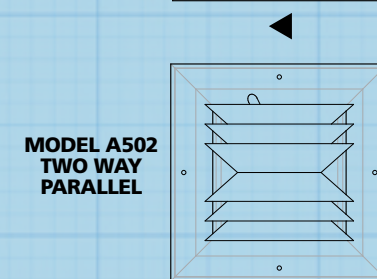
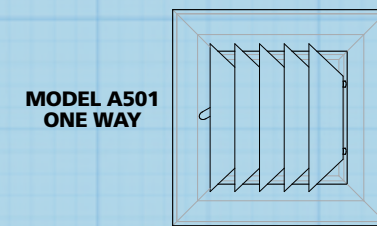

NOTE: All dimensions shown are typical for the A500 Series.

Model Number Specifications

Aluminum Directional Diffuser	A	5	0	2	M	18	x	08	Grille Height
Number of Throw Directions									Grille Width
1 = 1 Way									Damper Option
2 = 2 Way Parallel									M = Multi-Shutter Damper
3 = 3 Way									O = Opposed Blade Damper
4 = 4 Way									
5 = 2 Way Corner									

A500 SERIES STOCKING SIZES AND CARTON QUANTITY CHART

Register Size	A501M	A501-O	A502M	A502-O	A503M	A503-O	A504M	A504-O	A505M	A505-O
6 x 6	20	10	20	10	20	10	20	10	20	10
8 x 8	10	5	10	5	10	10	10	5	10	5
10 x 10	10	5	10	5	10	10	10	5	10	5
12 x 12	10	5	10	5	10	10	10	5	10	5
14 x 14	10	5	10		10	10	10	5	10	5

A500 Series Options

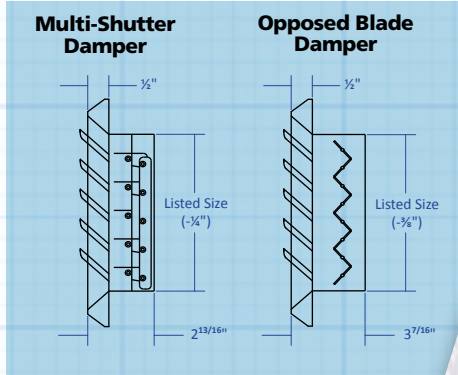

Model A503M

Detail view showing three-way air deflection pattern

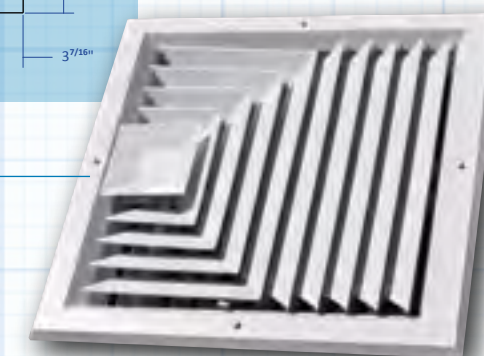

Opposed Blade Damper (O)

Our top of the line OBD Damper for the ultimate in air control

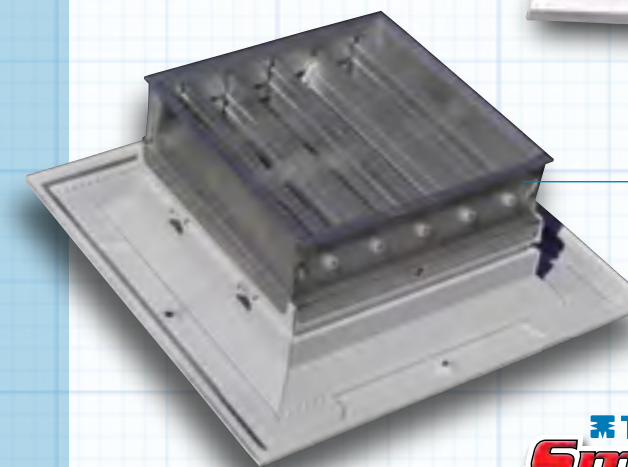

TRUaire
SmoothGlide

Durable Rivets installed AFTER powder coating for smoothest operation

Blade & linkage components are individually powder coated BEFORE assembly

A520 Series

These modular core products are manufactured in a surface mount design, bringing total versatility to any drywall or sheetrock ceiling installation. Made with the highest quality extruded aluminum, the removable "cores" can be arranged in one, two, three, four, and two-way corner throw configurations.

TruAire proudly offers two architecturally different frame styles; featuring either flat-frame or bevel-frame designs and an optional high-quality aluminum opposed blade damper system.



Model A520F
Flat-frame design

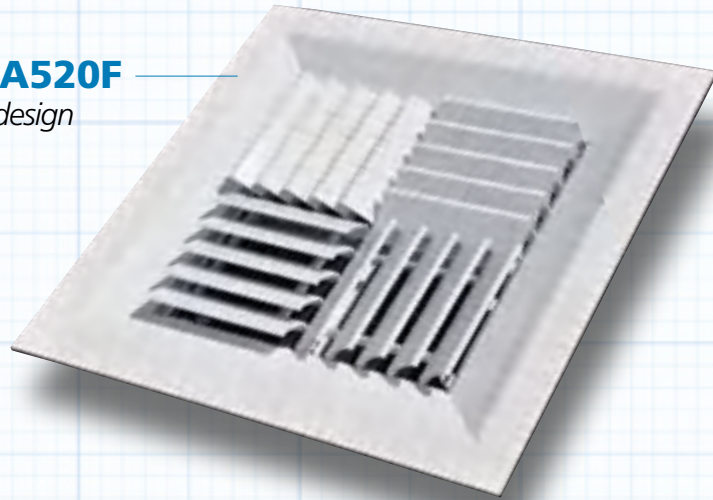

Model A520B
Beveled-frame design

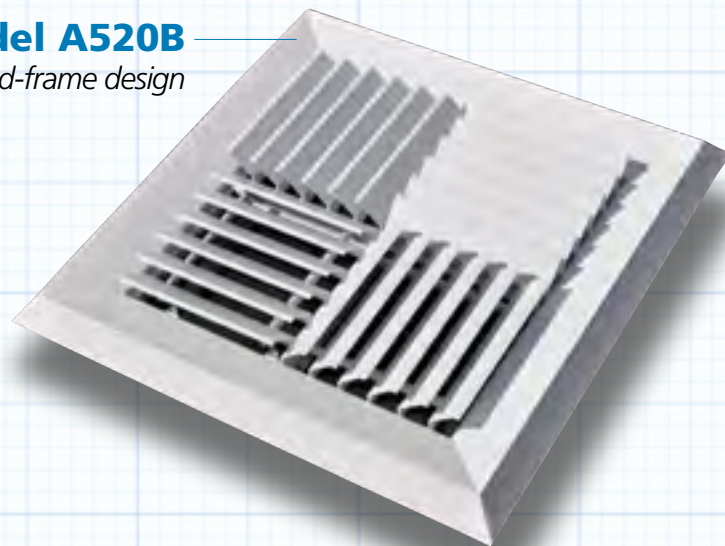

Compare to:	A520
Hart & Cooley	MCD-1
Titus	MCD-1
Shoemaker	MA
Metal Aire	9000
Price	AMCD
Krueger	1200

Features

- Extruded aluminum construction
- Beveled or flat frame options
- Field configurable throw patterns; one, two, three or four way
- Pristine white powder coat finish
- Optional opposed blade damper

Product Detail



Beveled Frame Design Flat Frame Design

A520 Series Options

Model A520F - Flat Frame Design
(Shown with detached core)

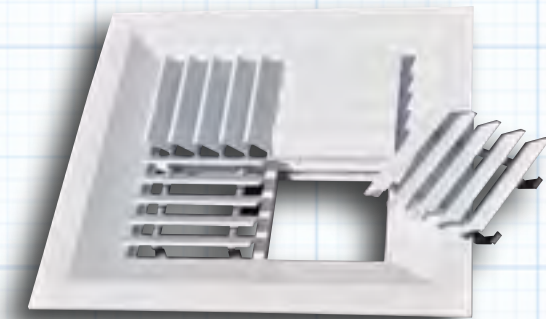

Remove cores to access screw holes along interior frame

Model A520F - Flat Frame

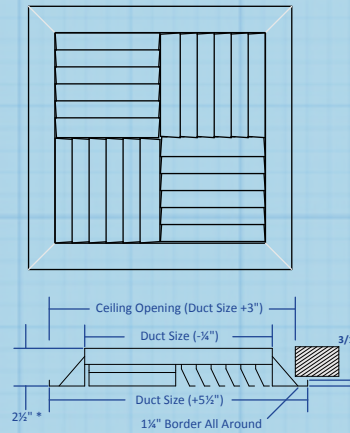

Model A520B - Beveled Frame

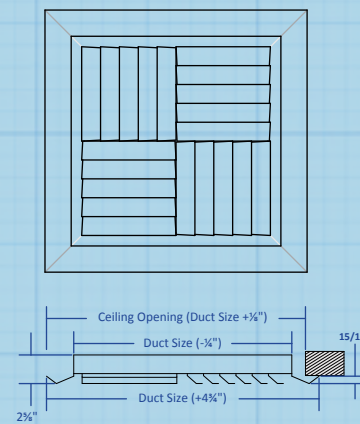

NOTE: Optional opposed blade damper increases the overall height by 1 1/2"

Optional Opposed Blade Damper

With quiet, high-quality nylon bushings



Reverse Side

Field Configurable Throw Patterns

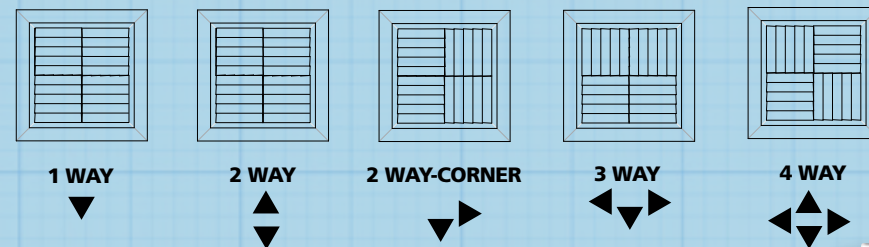

Detachable core panels can be arranged in a variety of airflow patterns

Model Number Specifications

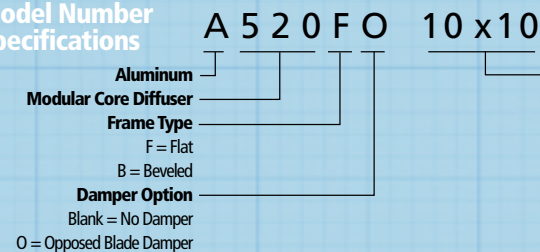

Model A520B Beveled Frame Design

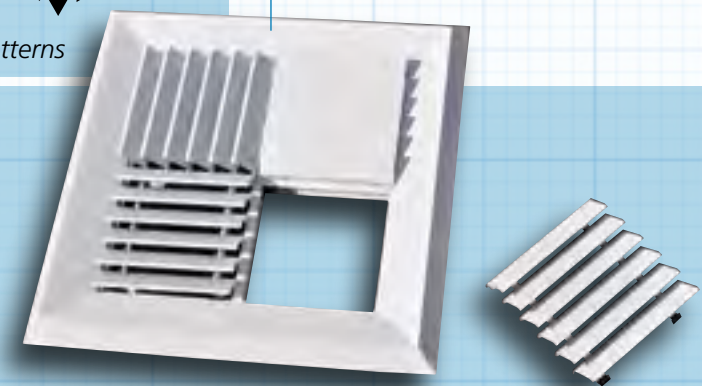

A540 Series

The Directional Diffusers made for surface mount installations represent an attractive alternative to other ceiling diffuser options. These diffusers are manufactured exclusively in highest quality extruded aluminum material, with removable cores and feature a sleek low profile blade design that comes in a Flat-frame or Beveled-frame style.

This is a versatile, attractive series for office installations with drywall/sheetrock ceilings instead of a T-Bar design. Each is available with optional aluminum opposed blade dampers and feature five airflow patterns.



Model A544F
Flat-frame design

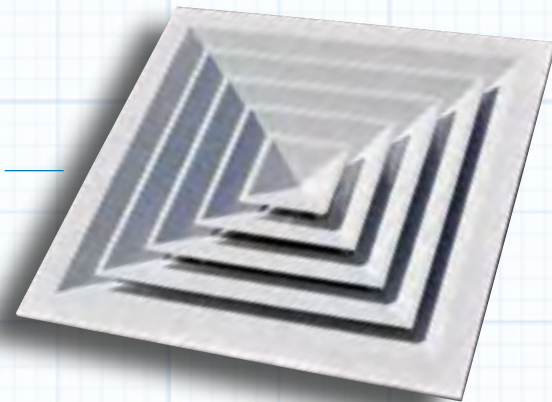

Model A544B
Beveled-frame design

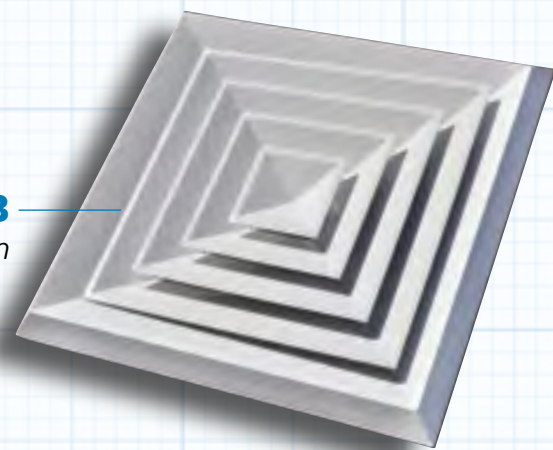

Compare to:	A540
Hart & Cooley	SRE/SRS
Titus	TDC
Shoemaker	DVD
Metal Aire	5500
Price	SMD
Krueger	SH

Features

- Extruded aluminum construction
- Beveled or flat frame options
- 5 air throw patterns
- Removable core
- Pristine white powder coat finish
- Optional opposed blade damper

Product Detail



Beveled Frame Design Flat Frame Design

MODEL A540F

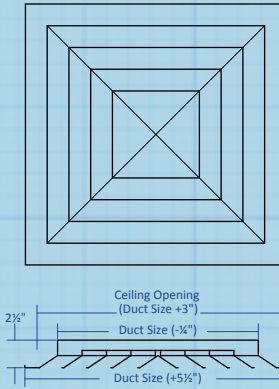

MODEL A540B

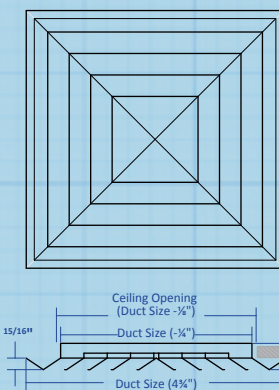

NOTE: Optional opposed blade damper increases the overall height by 1 1/2"

A540 Series Options

Model A544F - Flat Frame
(Shown with core attached)



Optional Opposed Blade Damper
With quiet, high-quality nylon bushings

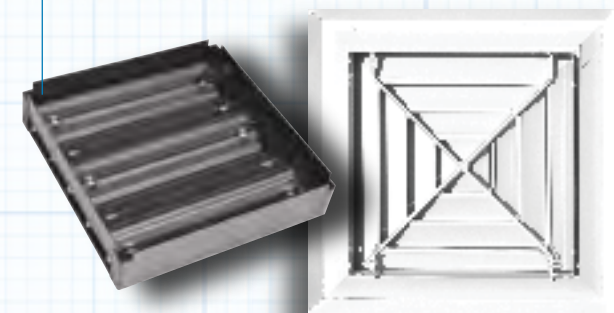

Reverse Side

Throw Patterns:

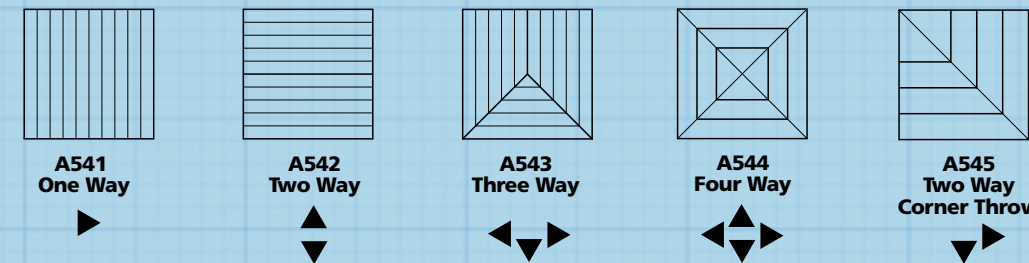

Model A544B Beveled Frame
(Shown with core removed)

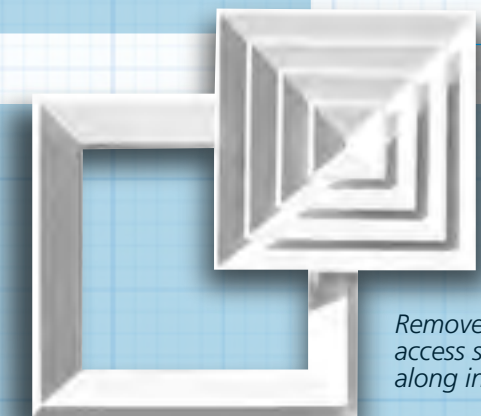

Remove cores to access screw holes along interior frame

Model Number Specifications

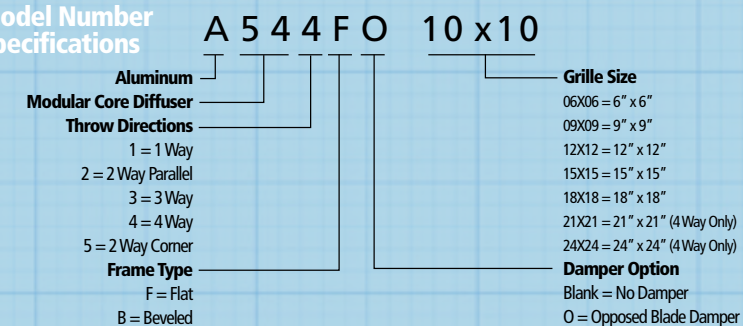

115 / 118 / 120 Series

TRUaire proudly offers a sunburst blade pattern baseboard model manufactured with the same high-quality features including SmoothGlide dampers and powder-coat finishes. This model comes in three different lengths.



SUPPLY

15" Shown

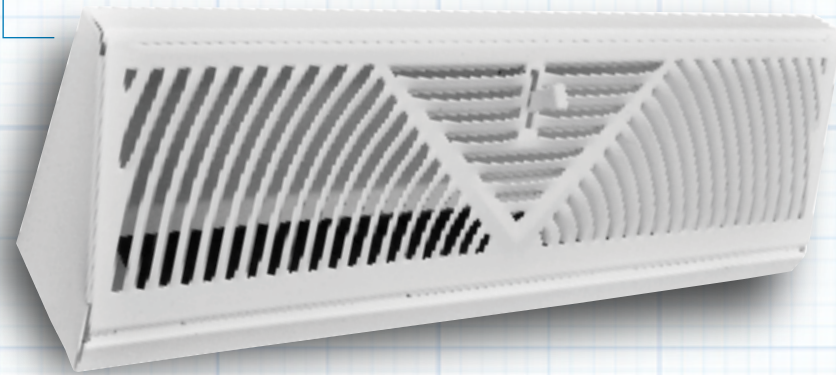

RETURN

15" Shown



Compare to: 115SW 115RW 118SW 118RW 120SW

	115SW	115RW	118SW	118RW	120SW
Hart & Cooley	470	471	470	471	462
Shoemaker	406	407	406	407	--
USAire	1330	1341	1340	1340	--
Continental	150	1505	180	1805	240
Lima	--	--	--	--	72
Airmate	350	351	350	351	350

Features

- Steel construction
- Available in sunburst blade pattern
- Supply register furnished with SmoothGlide dampers
- Available in either non-scuff textured brown or pristine white powder coat finish

Product Detail

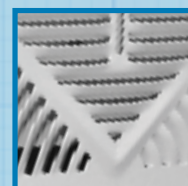

Detail View of Sunburst Fin Design



Easy-Open Tab Face

MODEL 115/118 Bottom and Side View

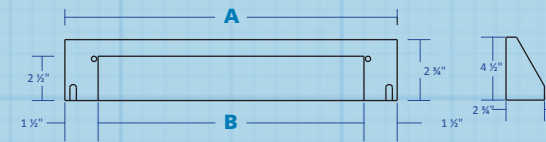

115 / 118 / 120 DIMENSIONS

MODEL	A	B
115	15	12
118	18	15
120	24	21

MODEL 120 Bottom and Side View

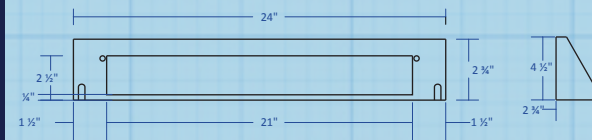

Available Sizes & Options

Model 115SW Supply

15" Shown - Also available in 18" & 24"

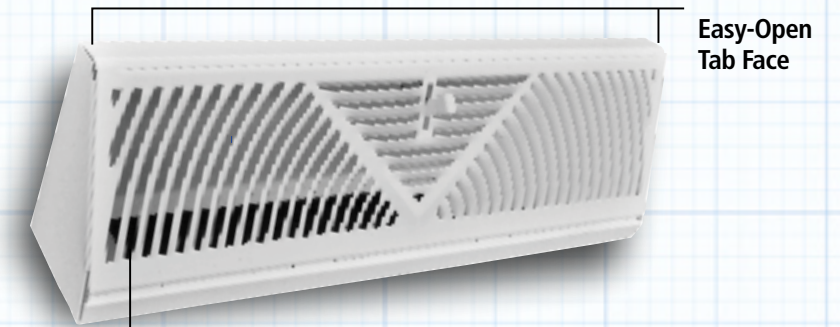

Sunburst fin design

Shown in OPEN position

Model 120SW Supply Only

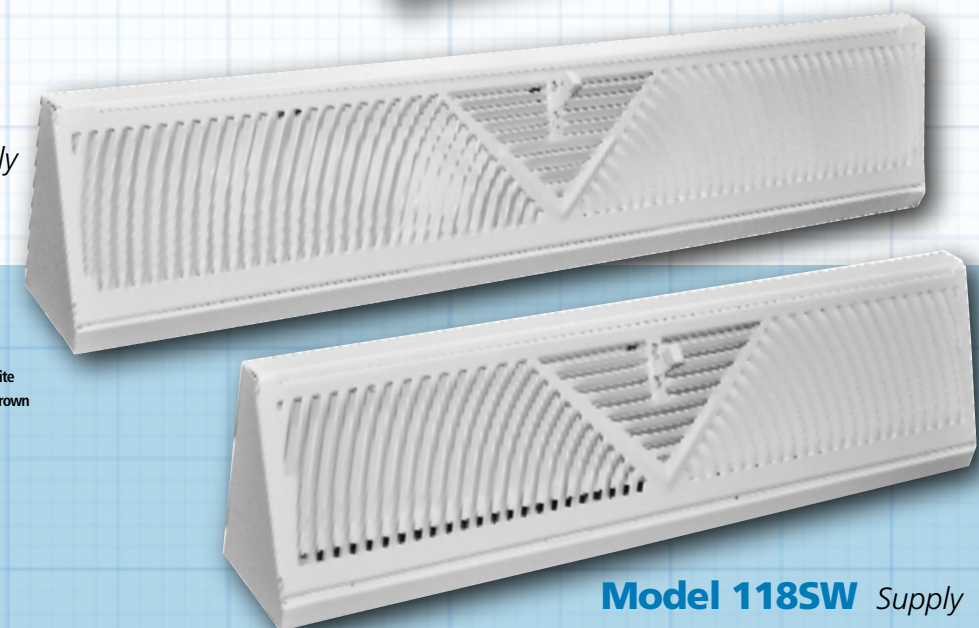

Model 118SW Supply

Model Number Specifications

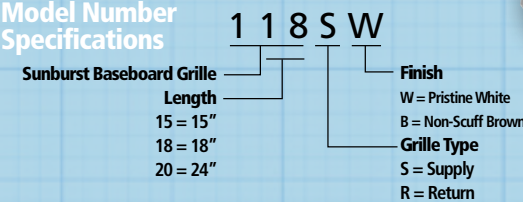

PLEASE CONTACT US FOR ANY SIZES NOT LISTED

Designer Baseboard Series

Each of our decorative baseboard diffusers allow the ability to update your home's look while also improving the heating or cooling. Choose from plated steel, resin composite or solid oak designs. These grilles are easy to install along the baseboard due to the removable faceplate and cleaning them is a snap.



SUPPLY

Oil Rubbed Bronze Finish



Satin Nickel Finish

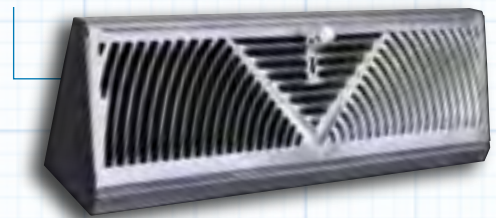

Resin Composite Baseboard White Finish

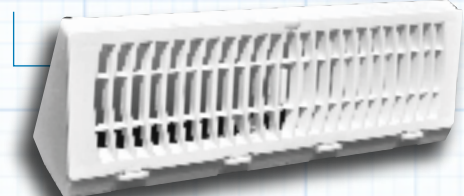

RETURN

Oil Rubbed Bronze Finish



Satin Nickel Finish



Resin Composite Baseboard Brown Finish



Compare to: 115S 115R 118S 118R

	115S	115R	118S	118R
Hart & Cooley	470	471	470	407
Shoemaker	875	875	875	875
USAire	1330	1341	1340	1340
Continental	150	1505	180	1805
Lima	470	471	470	471
Airmate	350	351	350	351

Features

- Steel construction (excluding models SWP and SBP)
- Models SWP and SBP are made from resin composite
- Sunburst blade pattern
- Easy opening tab face
- SmoothGlide damper (excluding SWP and SBP)

Finishes:

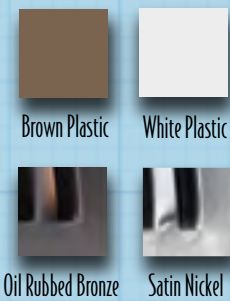

Product Detail



Resin Composite available in 2 finishes Easy-Open Tab Face

MODEL 115/118 Bottom and Side View

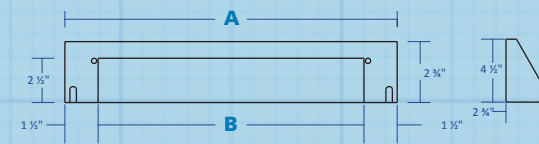

115 / 118 / 120 DIMENSIONS

MODEL	A	B
115	15	12
118	18	15
120	24	21

MODEL 120 Bottom and Side View

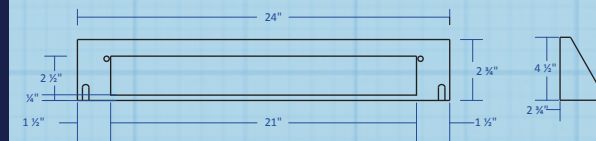

Available in White or Brown Finish

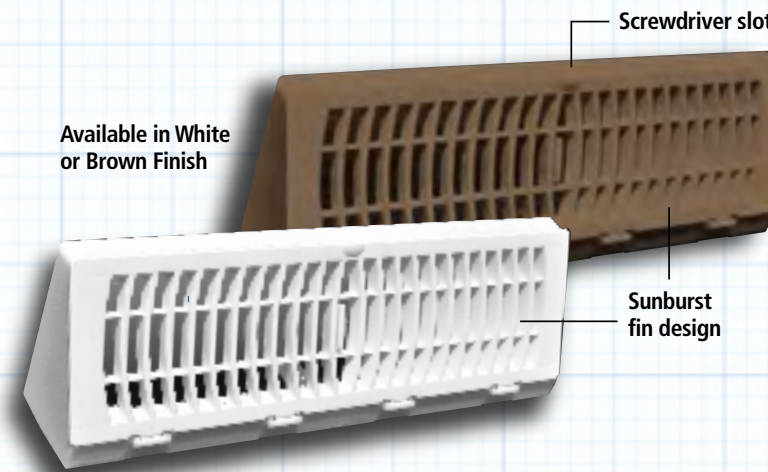

Model Number Specifications

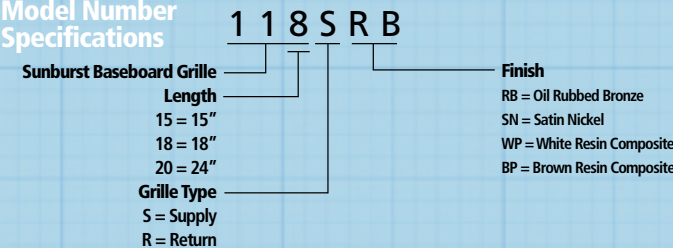

Shown in OPEN position

SUPPLY MODELS STOCKING SIZES AND CARTON QUANTITY CHART

Length (IN)	FINISH					
	W	B	RB	SN	WP	BP
15	20	20	20	20	20	20
18	20	20	20	20	20	20
24	10	10	10	10	N/A	N/A

RETURN MODELS STOCKING SIZES AND CARTON QUANTITY CHART

Length (IN)	FINISH					
	W	B	RB	SN	WP	BP
15	20	20				
18	20	20				
24	10				N/A	N/A

Model 115RB

15" Shown - Also available in 18" and 24".



Model 115SN

15" Shown - Also available in 18" and 24".

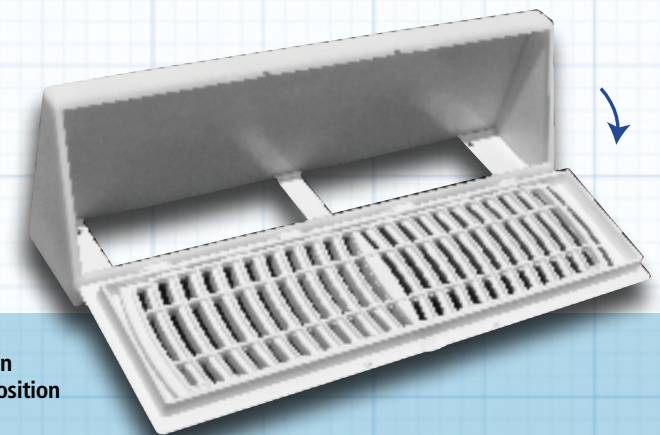

121S Series

TRUaire offers a deluxe baseboard diffuser manufactured with the same high-quality features including SmoothGlide dampers and powder coat finishes. This model comes in either a 24" length or 48" length.



Model 121SW-24

24" Deluxe Baseboard Diffuser

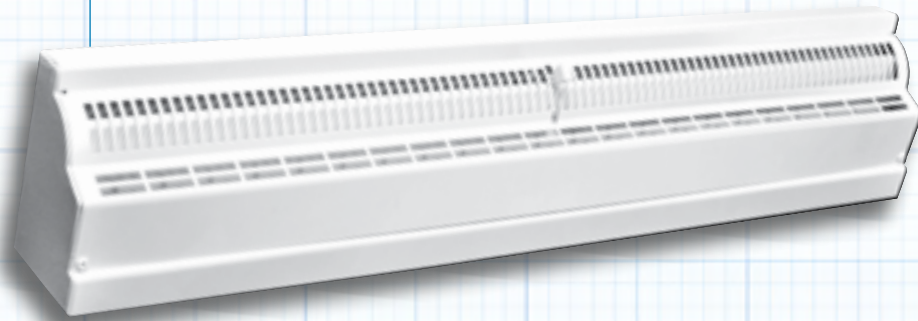

Compare to: 121S

Hart & Cooley	462
Shoemaker	-
USAire	-
Continental	240
Lima	72
Airmate	350

Features

- Steel construction
- Available in 24" and 48" lengths
- Supply register furnished with dampers
- Available in either non-scuff textured brown or pristine white powder coat finish

Available Finishes



Product Detail



Slotted Vent Design Detail View of Damper Latch

Sizes & Carton Quantity Chart

	121SW-24	121SB-24	121SW-48	121SB-48
SIZE				
24	10	10		
48			1	1

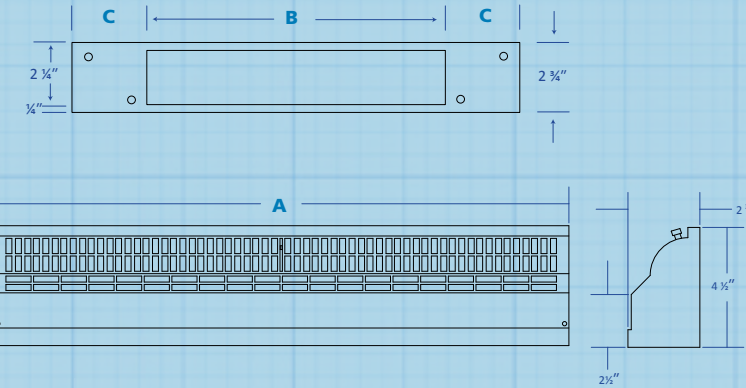

121S-24 & 121S-48 SIZING & DIMENSIONS

MODEL	A	B	C
24	24	16	4
48	48	24	12

Available Sizes & Options

Model 121SW-48 Supply
48" Shown - Also available in 24"

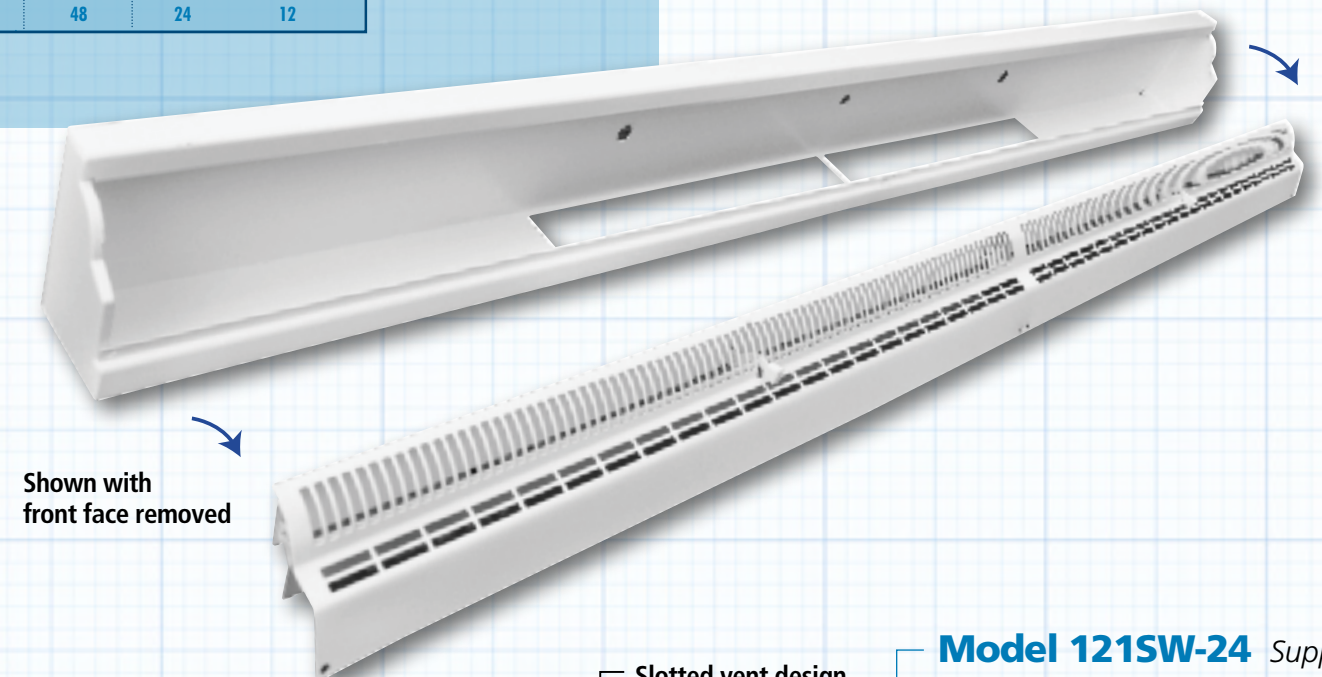

Shown with front face removed

Model 121SW-24 Supply
24" Shown - Also available in 48"



Slotted vent design

Model Number Specifications

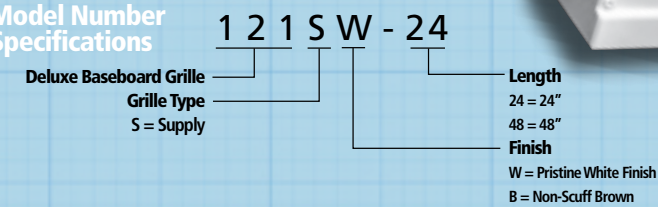

122 / 123 Series

TRUaire proudly offers a complete line of baseboard products, manufactured with the same high-quality features including SmoothGlide dampers and pristine powder-coating. Most of these models are available in 1/2" or 1/3" blade spacing.



Model 123SD-1

Two Way - 1/2" Spaced Blade - 1/4" Turnback

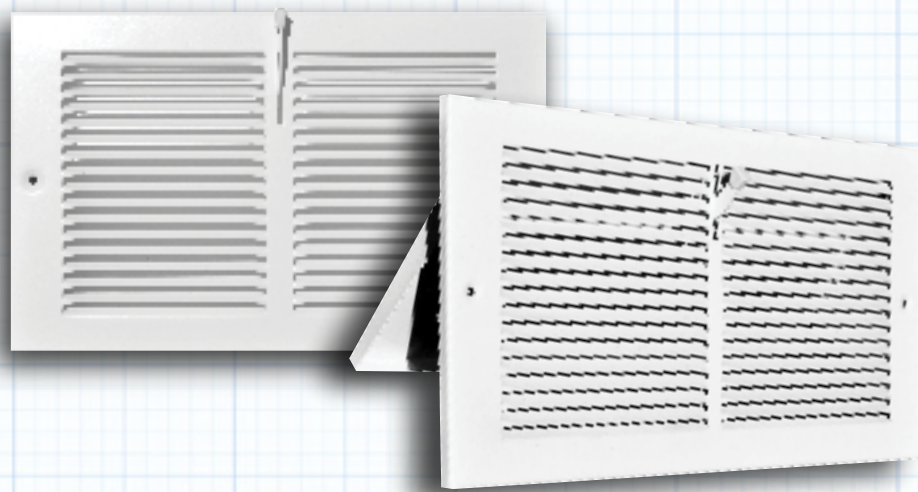

Model 122RW

One Way - 1/2" Spaced Blade - 3/4" Turnback

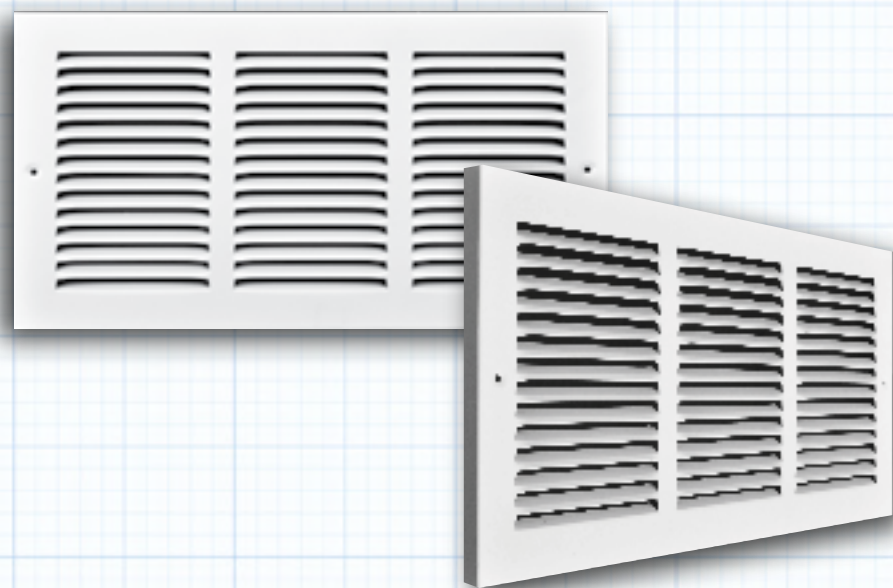

Compare to: 122

Hart & Cooley	674
Shoemaker	1150
USAire	-
Continental	BG21
Lima	60GH7
Airmate	171

Features

- Steel construction
- Available in 1/2" and 1/3" blade spacing
- Countersunk screw holes
- Supply register furnished with SmoothGlide damper
- Pristine white powder coat finish

Product Detail

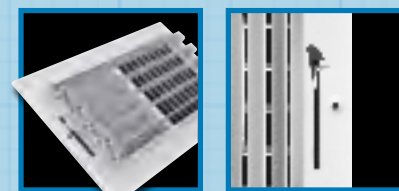

SmoothGlide Damper Linkage and Rivets Detail View of Damper Latch

RETURN

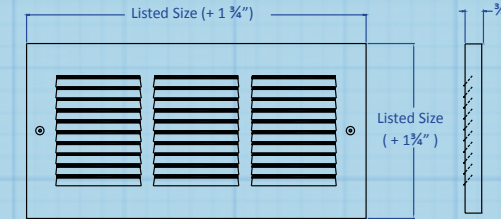

SUPPLY

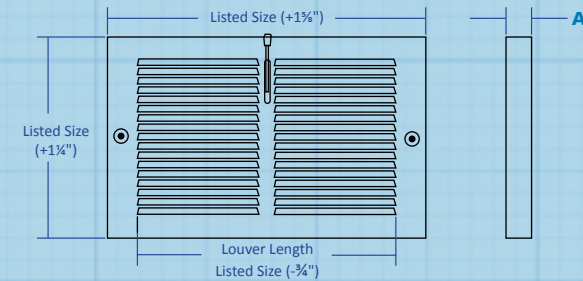

MODEL	A
122SD-1	1/4"
122SD-2	3/4"

Model 123SD-2

Two Way - 1/2" Spaced Blade
3/4" Turnback

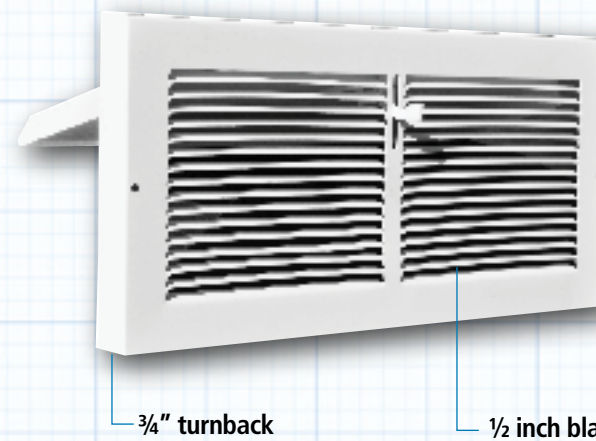

Model 122RW

One Way - 1/2" Spaced Blade
3/4" Turnback

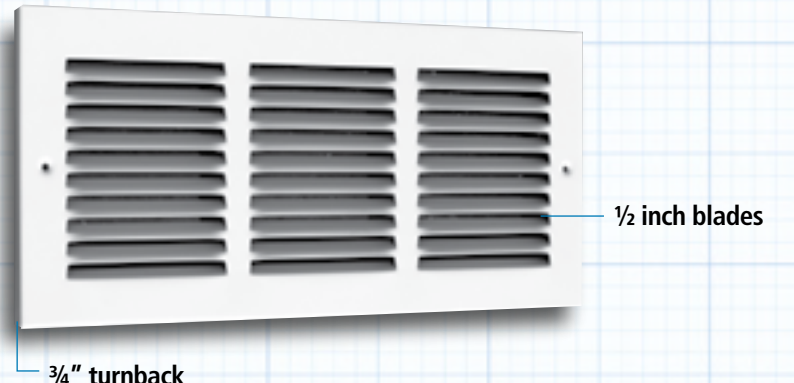

Model Number Specifications

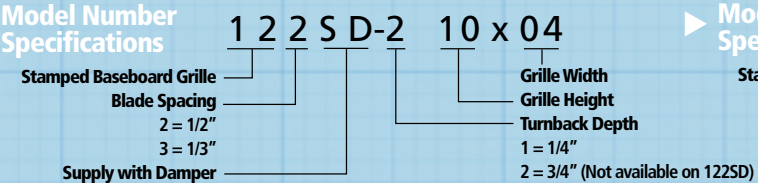

SUPPLY

Model Number Specifications

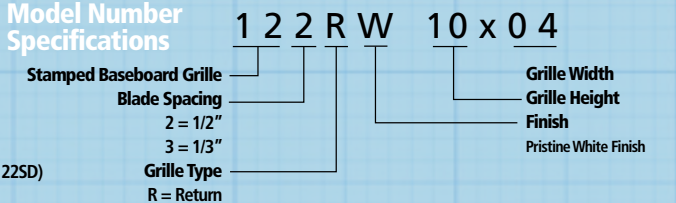

RETURN

122/123 Series

Size (IN)	122RW	122SD-1	123RW	123SD-1	123SD-2
8 x 4		20	20	20	
8 x 6		20	20	20	
10 x 4		20		20	
10 x 6	20	20	20	20	10
10 x 8	20		20		
12 x 4		20		20	
12 x 6	20	20	20	20	10
12 x 8	20		20		
14 x 4			20		
14 x 6		20		20	10
14 x 8	20		20		
14 x 10	20		20		
16 x 6	20		20		
16 x 8	20		20		
20 x 6	20		10		
20 x 8	10		10		
20 x 10			10		
24 x 6	20		20		
24 x 8	10		10		
24 x 10	10		10		
24 x 12	10		10		
30 x 6	20		20		
30 x 8	10		10		
30 x 10	10		10		
30 x 12	10		10		
30 x 14	5				
36 x 6	10		10		
36 x 8	10		10		
36 x 10	10				
36 x 12	5				

123M/124M/125T Series

TRUaire proudly offers a complete line of baseboard products, manufactured with the same high-quality features including SmoothGlide dampers and pristine powder-coating. Most of these models are available in a variety of fin designs, fin spacing, and in either white or brown finishes.



Model 123M

Two Way 1/3" Spaced Blade - 3/4" Turnback



Model 124M

Sidewall Supply - Bottom Open - 3/4" Turnback

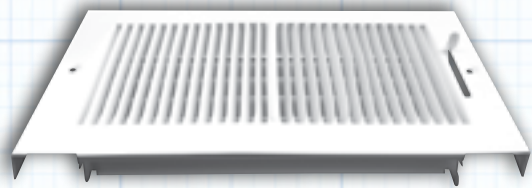

Model 125TS

Single Damper - Supply 1/3" Blade Spacing

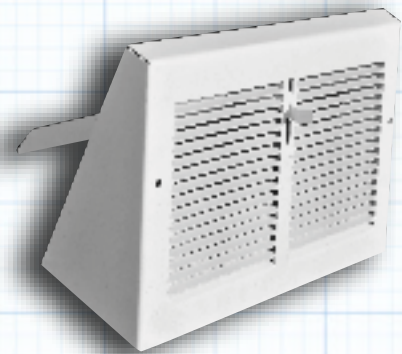

Model 125TR

No Damper - Return 1/3" Blade Spacing



Compare to: 123M 123R 124M 125TR 125TS

Hart & Cooley	664	657	-	658	655
Shoemaker	855	133	855	1165	-
USAire	1300	-	-	-	-
Continental	BG32	BG31	B32	BEG21	55
Lima	-	671	667	652	649
Airmate	-	174	164	-	-

Features

- Steel construction
- Available in 1/3" blade spacing
- Countersunk screw holes
- Supply register furnished with SmoothGlide dampers
- Pristine white powder coat finish

Product Detail

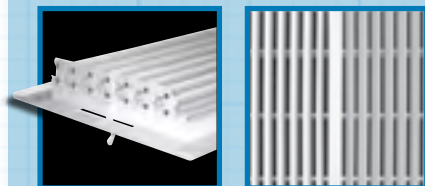

SmoothGlide Damper Linkage and Rivets 1/3" Blade Spacing

123M / 124M / 125T Series Options

STOCKING SIZES AND CARTON QTY CHART

Register Size (IN)	MODEL		
	124M	125TS	125TR
8 x 6		10	
10 x 6	20	10	10
10 x 8	20		
12 x 6	20	10	10
12 x 8	20		
14 x 6	20	10	10
14 x 8	10		10
24 x 6			10
24 x 8			10
30 x 6			10
30 x 8			10

Model 124M

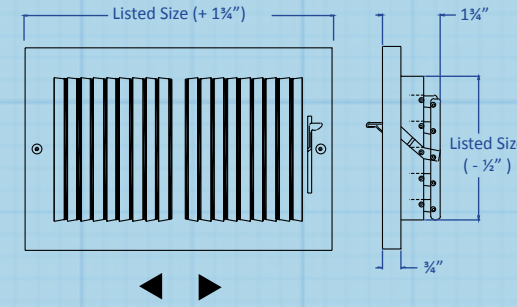

Model 125TS

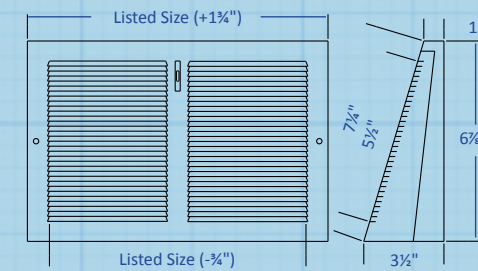

Model 125TR

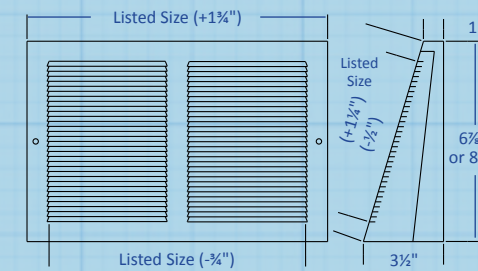

Model 124M

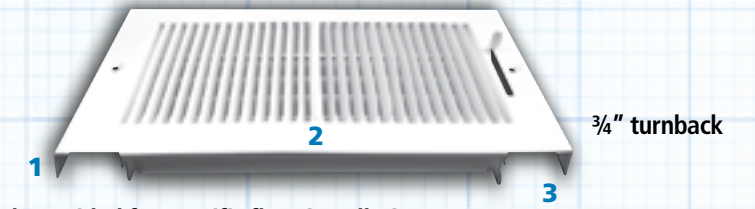

Three-sided for specific floor installations - Without a fourth turnback side on bottom

Model 125T

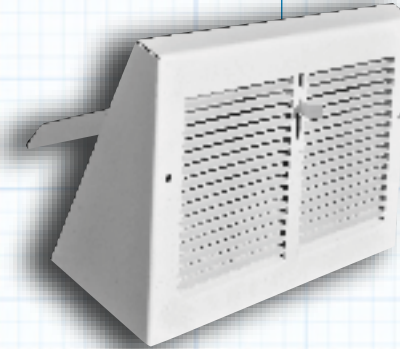

Model Number Specifications

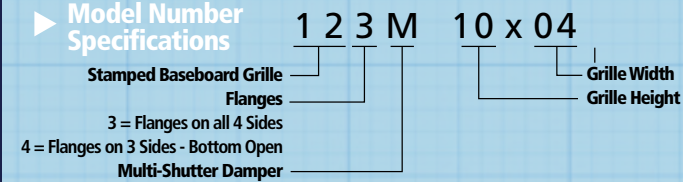

Model Number Specifications

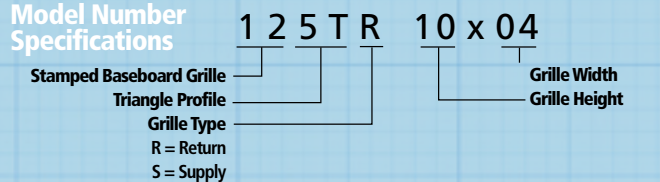

150M Series

The 150M floor register series represents a wide range of variety, creative design and bold innovation. Even the most basic model brings with it unparalleled standards of excellence that is the hallmark of the TRUaire brand. This wide variety of designs includes the basic register model, the deluxe register model and the over-sized mobile home model. Each is available in our high quality non-scuff textured brown or white powder-coat finish.



Model 150MB

Two Way - Brown Finish



Model 150MW

Two Way - White Finish

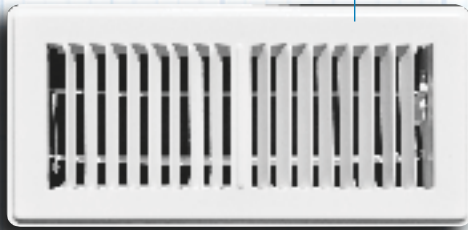

Model 153MB

Three Way - Brown Finish



Model 153MW

Three Way - White Finish



Model 155MM Mobile Home



Model 155MW Mobile Home

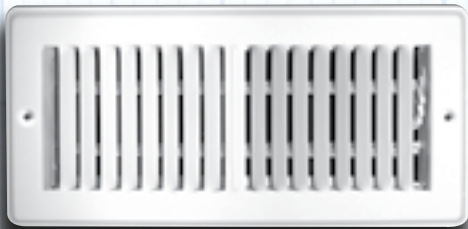

Model 157MB

Deluxe - Brown Finish



Model 157MW

Deluxe - White Finish



Compare to:	150	153	150T	150R
Hart & Cooley	421	--	420	265
Shoemaker	350	--	TS	1600
USAire	1510D	--	1320	1530
Continental	28	--	TG32	F25
Lima	800	--	875	825
Airmate	302	--	301	325

Features

- Heavy steel construction
- Countersunk screw holes on Model 155M
- One piece frame
- SmoothGlide multi-shutter damper
- Foot operated wheel control
- Available in either non-scuff textured brown or pristine white powder coat finish

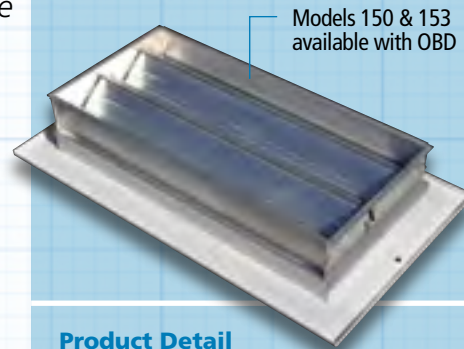

Models 150 & 153 available with OBD

Product Detail



SmoothGlide Damper Linkage and Rivets Revolutionary, New Three-Way Floor Register

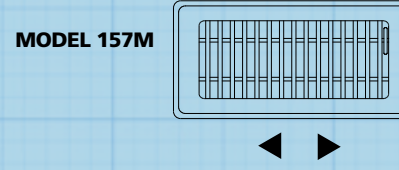
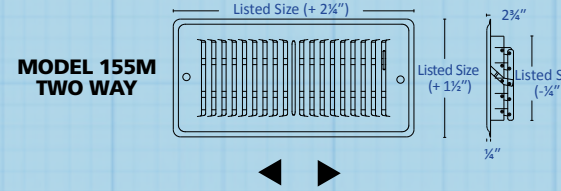
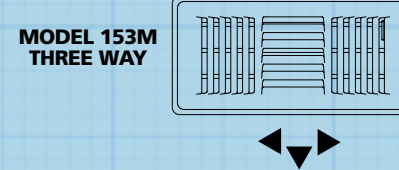
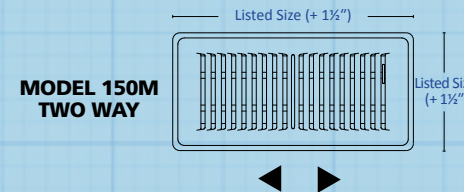
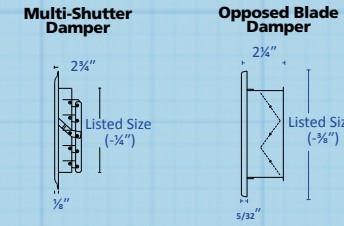

150 Series Options

Specifically designed for greater airflow, which means lower energy costs for you and your home. Available in either white or brown finish and in standard 4"x10" and 4"x12" sizes.

Model 150MB

Two Way - Brown Finish



Model 153MB

Three Way - Brown Finish



Model 155MM Mobile Home



Featuring a wider frame and counter-sunk screw holes, which is ideal for the Mobile Home industry.

Model 157MB Deluxe - Brown Finish



The Deluxe Model is manufactured with individually welded blades, each set at gradually greater angles, for better air dispersion.

Durable Rivets installed AFTER powder coating for smoothest operation

Blade & linkage components are individually powder coated BEFORE assembly

Model Number Specifications

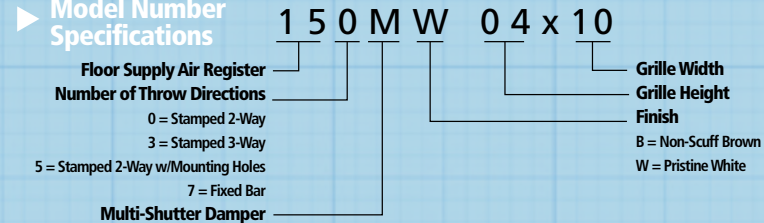

150 SERIES STOCKING SIZES AND CARTON QTY CHART

Register Size (IN)	WIDTH (IN)			
	150MB/MW	153MB/MW	155MM/MW	157MB/MW
2 x 8	20			
2 x 10	20		20	20
2 x 12	20		20	20
2 x 14	20		20	20
4 x 8	20		20	20
4 x 10	20	20	20	20
4 x 12	10	10		20
4 x 14	10	10		10
6 x 8	20			20
6 x 10	10	10	10	10
6 x 12	10	10		10
6 x 14	10	10		10

150TS / 173TS Series

Each model in the toe space grille lineup offers an understated yet dependable and simple vent underneath your cabinet. Available in brown or white, this is a grille only, no damper product.



Model 150TSW

Grille - White Finish

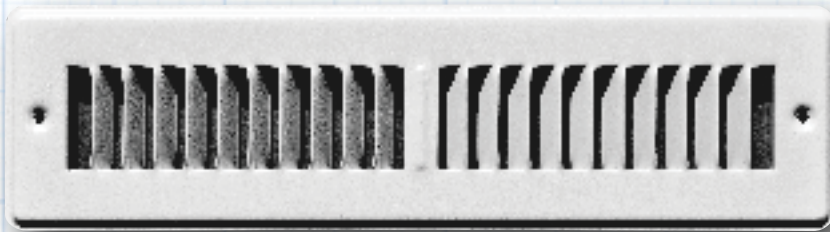

Model 150TSB

Grille - Brown Finish



Model 173TSW

Grille - White Finish



Model 173TSB

Grille - Brown Finish



Compare to: 150TS 173TS

Hart & Cooley	420
Shoemaker	TS
Continental	TG32
USAire	1320

Features

- Steel construction
- Countersunk screw holes
- Available in non-scuff brown or pristine white powder coat

Finishes

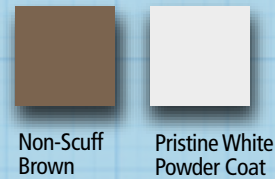

Product Detail

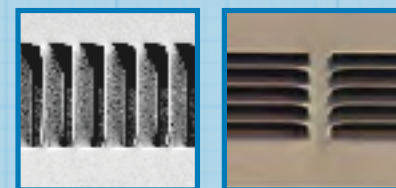

1/2" Blade Spacing on 150TS Models

1/3" Blade Spacing on 173TS Models

150TS AND 173TS SERIES STOCKING SIZES AND CARTON QUANTITY CHART

Register Size (IN)	MODEL			
	150TSB	150TSW	173TSB	173TSW
2 x 8	20	20		
2 x 10	20	20	20	20
2 x 12	20	20	20	20
2 x 14	20	20	20	20
4 x 8	20	20		
4 x 10	20	20		
4 x 12	20	20		
4 x 14	20	20		
6 x 8		20		
6 x 10	20	20		
6 x 12	20	20		
6 x 14	20	20		

Model 150TS

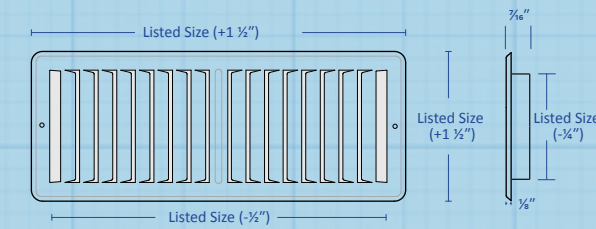

Model 173TS

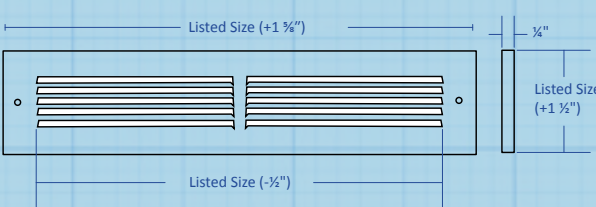

Available Sizes & Options

Model 150TSW

Heavy Duty Toe Space Grille (04" x 10" Size Shown)

Two Way Air Deflection

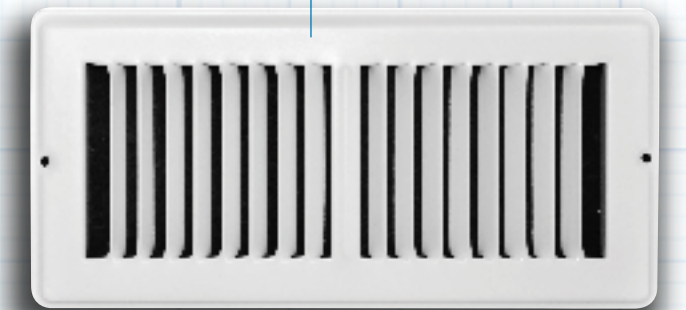

Model 173TSW

Heavy Duty Floor Grille (02" x 10" Size Shown)

Reverse Side Shown



Model Number Specifications

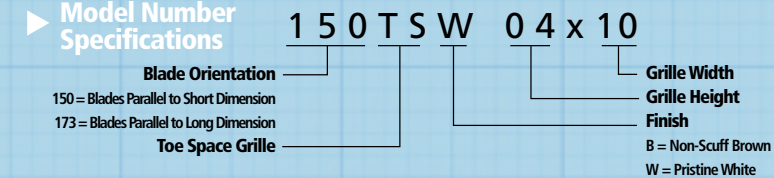

154 Series

These two different floor application products round out the TRUaire floor grille offering, in two very different ways. The 154 Series is perfect when the application calls for extra strength and rigidity in the floor grille. Generally used as a return air product, several sizes are available with an aluminum opposed blade damper.

Model 154-O

Supply register with OBD damper



Model 154R

Return grille



Compare to: 154R 154-O

Hart & Cooley	265	210
Shoemaker	1600	1550
Continental	F25	F20
USAire	1530	1530M

Features

- Steel construction
- Aluminum opposed blade damper
- Non-scuff brown powder coat finish

Finishes



Non-Scuff Brown

Product Detail



Reinforced for extra strength & durability

Detail view of durable bushings on OBD

154R SERIES STOCKING SIZES AND CARTON QUANTITIES

Height (IN)	WIDTH (IN)												
	4	6	8	10	12	14	16	18	20	24	25	30	36
4			10	10	10	10	10	10	10	10		5	
6			10	10	10	10	10	10	5	5		5	2
8	10	10	10	10	10	10	5	5	5	5		5	
10				10	10	5	5	5	5	5		5	
12				10	5	5	5	5	5	5		2	
14						5	5		5	2		2	
16							2	2	2	2		2	
18								2	2	2		2	2
20					5	5			2	2	2	2	
24										2		2	1
30								2					

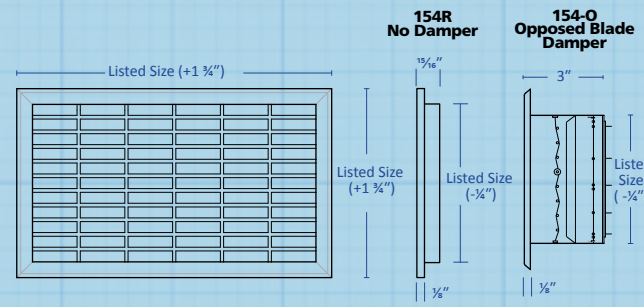

154-O SERIES STOCKING SIZES AND CARTON QUANTITIES

Height (IN)	WIDTH (IN)							
	4	6	18	20	24	25	30	36
4			10	5	5			
6				5	5	5		
8			X	X	5		5	
10					X	5		
12						X		
20								5

Model 154R

Heavy Duty without damper (Reverse side shown)



Model 154-O

Heavy Duty with OBD Option (Reverse side shown)

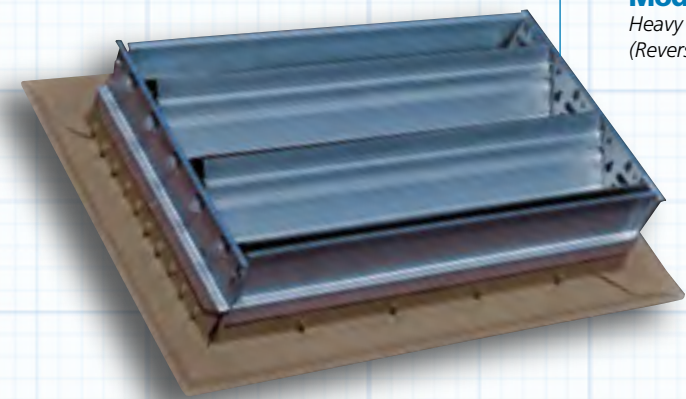

Model Number Specifications

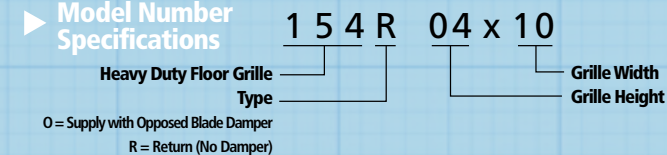

O = Supply with Opposed Blade Damper
R = Return (No Damper)

160 Designer Series

Inspired by fine interiors the world over, TRUaire's Designer Series™ collection of air vent covers, registers and grilles is designed to fit over any existing or new floor opening. Each register is handcrafted using quality materials and remarkable craftsmanship suited for an array of fine architectural styles while complimenting any home's interior.



Model 163

Retro Couture Design

Model 164

Ornamental Scroll Design

Model 165

Cosmopolitan Design

Designer's Series™

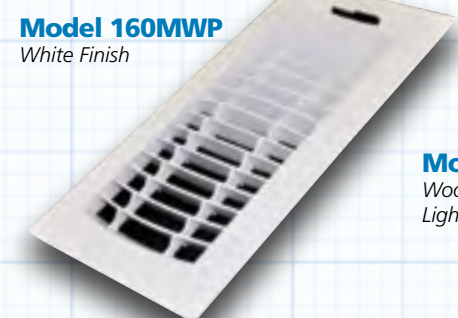
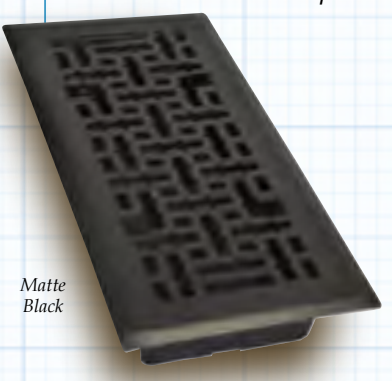
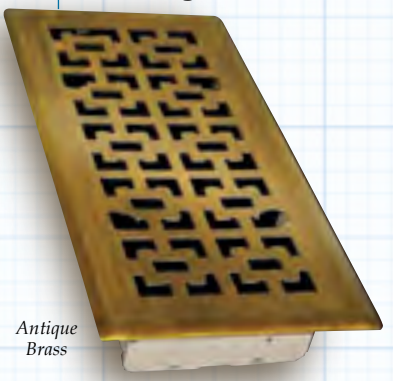
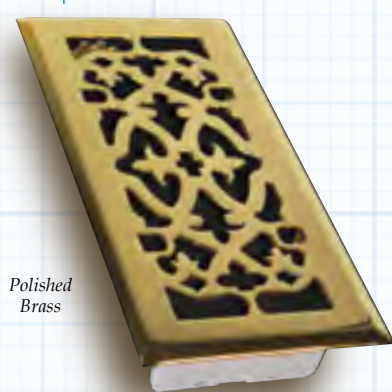
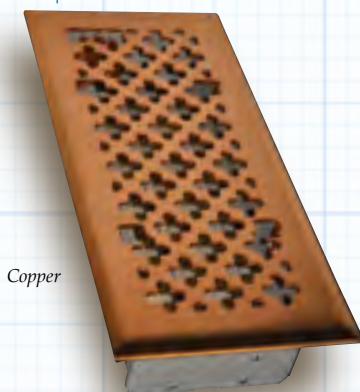

Features

- Steel construction (excluding Model 160)
- Model 160 is made of resin composite
- SmoothGlide multi-shutter damper
- Five decorative designs
- Six designer finishes

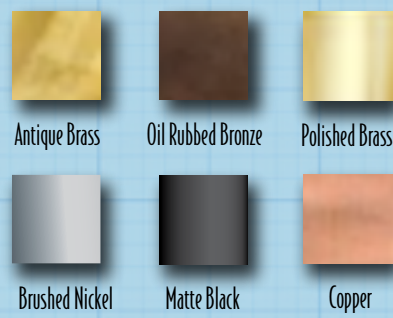

Product Detail



Durable, Laser-Cut Decorative | SmoothGlide Multi-Shutter Damper

163 thru 167 Models

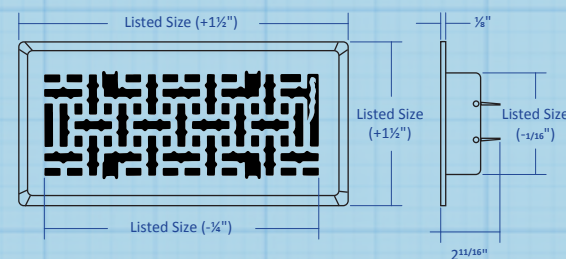

NOTE: Model 167 shown. All dimensions are typical for Models 163 through 167.

Model 160

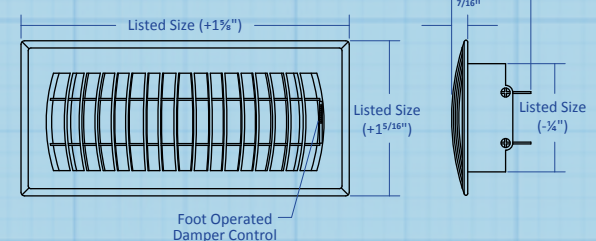

NOTE: Model 160 shown. All dimensions are typical for 160 Series Models.

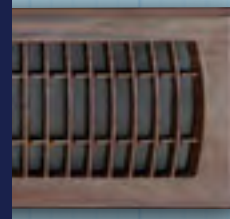

Wood - Dark

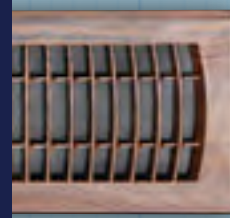

Wood - Medium

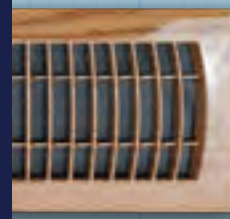

Wood - Light



White

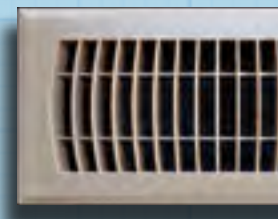

Brown

Model 160 Resin Composite Collection

Model 160 Stocking Sizes and Carton Quantity Chart

Register Size (IN)	FINISH				
	BP	WP	MLP	MMP	MDP
2 x 12	20		10	10	10
4 x 8			10	10	10
4 x 10	20	20	10	10	10
4 x 12		10	10	10	10

Model 163 Retro Couture

Model 163 Stocking Sizes and Carton Quantity Chart

Register Size (IN)	FINISH					
	OB	AB	CP	PB	SN	MB
2 x 12			10			
4 x 8	10					
4 x 10			10		10	
4 x 12						



Copper

Model 164 Ornamental Scroll

Model 164 Stocking Sizes and Carton Quantity Chart

Register Size (IN)	FINISH					
	OB	AB	CP	PB	SN	MB
2 x 12	10				10	
4 x 8	10				10	
4 x 10	10	10	10	10	10	10
4 x 12	10	10			10	10



Satin Nickel

Model 165 Cosmopolitan

Model 165 Stocking Sizes and Carton Quantity Chart

Register Size (IN)	FINISH					
	OB	AB	CP	PB	SN	MB
2 x 12	10	10				
4 x 8	10					
4 x 10	10	10				
4 x 12	10					



Oil Rubbed Bronze

Model 166 Vintage Victorian

Model 166 Stocking Sizes and Carton Quantity Chart

Register Size (IN)	FINISH					
	OB	AB	CP	PB	SN	MB
2 x 12		10	10			
4 x 8		10				
4 x 10		10				
4 x 12						



Antique Brass

Model 167 Modern Contempo

Model 167 Stocking Sizes and Carton Quantity Chart

Register Size (IN)	FINISH					
	OB	AB	CP	PB	SN	MB
2 x 12		10	10			
4 x 8		10				
4 x 10		10				
4 x 12						



Matte Black

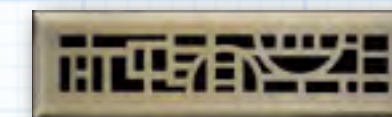

Each design and finish also available in space saving 2" x 12" dimension.

Model Number Specifications

163 - R A B 04 x 10

- Designer's Series
- Grille Face
- 0-M = Resin Composite
- 3-R = Retro Couture
- 4-O = Ornamental Scroll
- 5-C = Cosmopolitan
- 6-V = Vintage Victorian
- 7-M = Modern Contemporary
- Grille Width
- Grille Height
- Finish
- OB = Oil Rubbed Bronze
- AB = Antique Brass CP = Copper
- PB = Polished Brass SN = Satin Nickel
- MB = Matte Black
- BP = Brown (Model 160M Only)
- WP = White (Model 160M Only)
- LW = Light Wood Grain (Model 160 Only)
- MW = Medium Wood Grain (Model 160 Only)
- DW = Dark Wood Grain (Model 160 Only)

168 Solid Oak Series

Inspired by fine interiors the world over, TRUaire's Designer Series™ collection of air vent covers, registers and grilles is designed to fit over any existing or new floor opening. Each register is handcrafted using quality materials and remarkable craftsmanship suited for an array of fine architectural styles while complimenting any home's interior.



Model 168-FL
Solid Oak Floor

Model 168-SQ
Solid Oak Square Floor



Shown in Light Finish

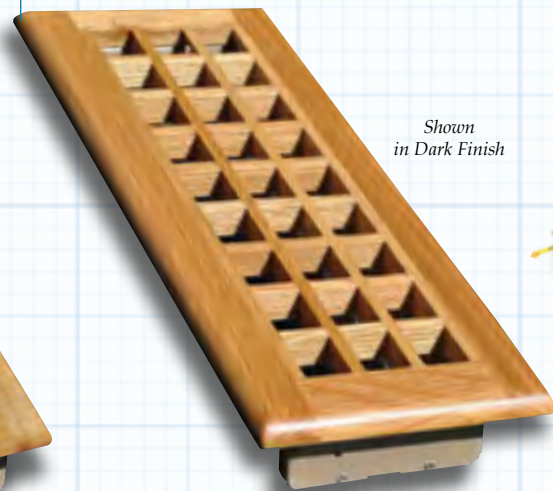

Shown in Dark Finish



Features

- Solid red oak construction
- Choose from three designer finishes
- SmoothGlide multi-shutter damper

Solid Oak Finishes Available:



Unfinished Light Finish Dark Finish

Product Detail



Hand Assembled Oak Components Made from solid wood and hand-stained

Model 168-FM
Solid Oak Flush Mount



Shown in Light Finish

Model 168-SW
Solid Oak Sidewall

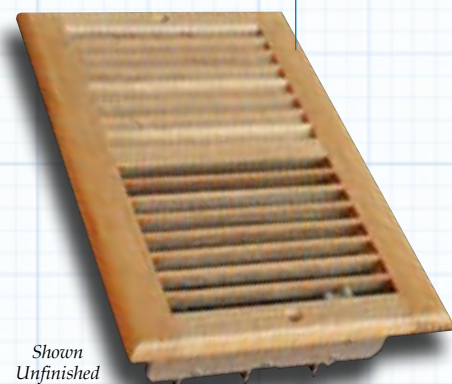

Shown Unfinished

Model 168-BB
Solid Oak Baseboard



Shown in Dark Finish

MODEL 168-FL

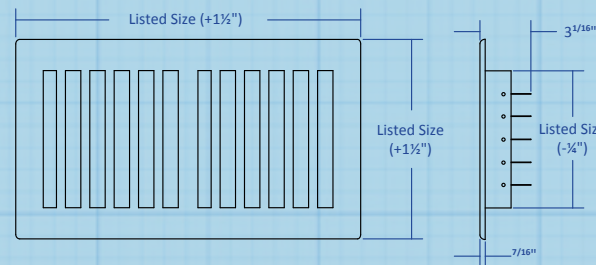

MODEL 168-FM

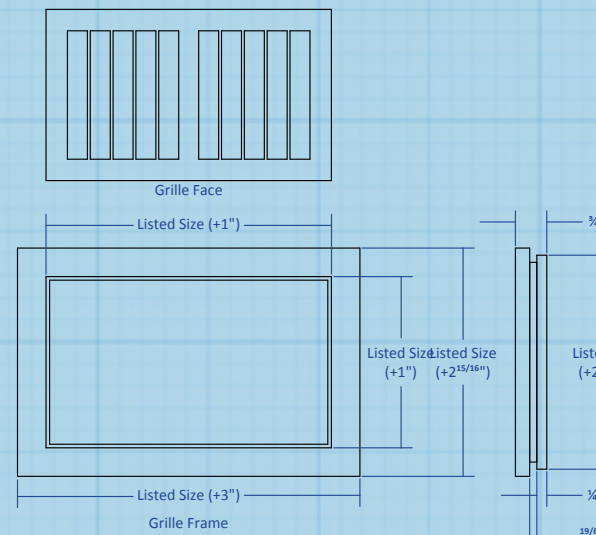

MODEL 168-SQ

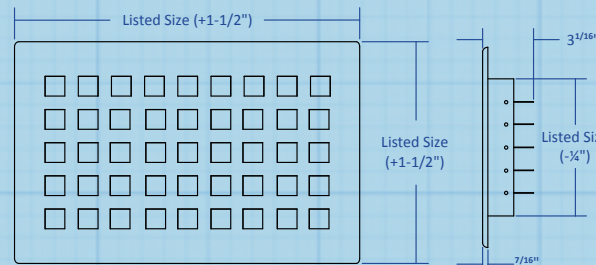

MODEL 168-SW

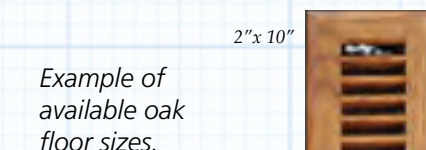
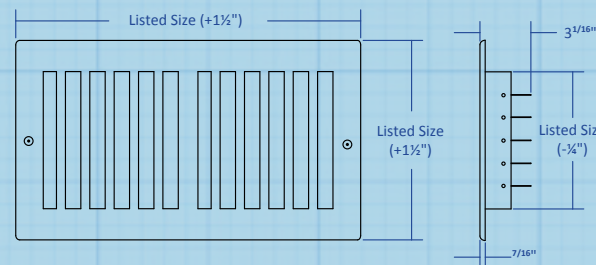

Example of available oak floor sizes.



4\"/>

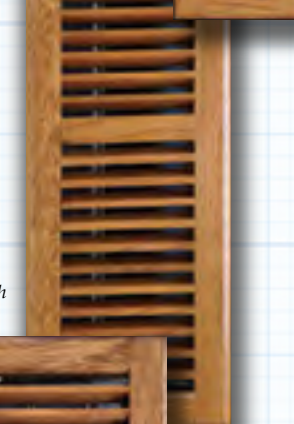

Shown in Dark Finish



6\"/>

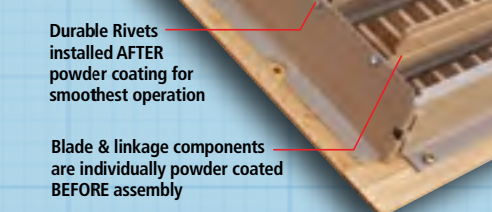

Durable Rivets installed AFTER powder coating for smoothest operation

Blade & linkage components are individually powder coated BEFORE assembly

Model 168-BB Stacking Sizes and Carton Quantity Chart

Register Size (IN)	Finish		
	Dark	Light	Unfinished
15			20
18			10

Model 168-FL Stacking Sizes and Carton Quantity Chart

Register Size (IN)	Finish		
	Dark	Light	Unfinished
2 x 10	10		20
2 x 12	10		20
2 x 14	10		20
4 x 10	20	20	20
4 x 12	10		10
4 x 14		10	
6 x 10	10		5
6 x 12		20	
6 x 14		10	5

Model 168-FM Stacking Sizes and Carton Quantity Chart

Register Size (IN)	Finish		
	Dark	Light	Unfinished
2 x 10	10	10	10
2 x 12	10	10	10
4 x 10	10	10	10
4 x 12	10	10	10
6 x 10	10	10	10
6 x 12	10	10	10

Model 168-SQ Stacking Sizes and Carton Quantity Chart

Register Size (IN)	Finish		
	Dark	Light	Unfinished
2 x 10			
2 x 12			
4 x 10	20		20
4 x 12	10		10
6 x 10			10
6 x 12	10		10

Model 168-SW Stacking Sizes and Carton Quantity Chart

Register Size (IN)	Finish		
	Dark	Light	Unfinished
10 x 4			
10 x 6		10	10
12 x 4			
12 x 6			

170 Series

Stamped steel return grilles represent the most economical way to provide return air. These high quality stamped steel models are not only available in a wide variety of sizes, but blade design, and blade spacing as well. Although most commonly found in a pristine white powder-coat finish, the model 170 is also available in a brown finish.



Model 170
Stamped Return Grille
1/2" Blade Spacing



Model 173
Stamped Return Grille
1/3" Blade Spacing

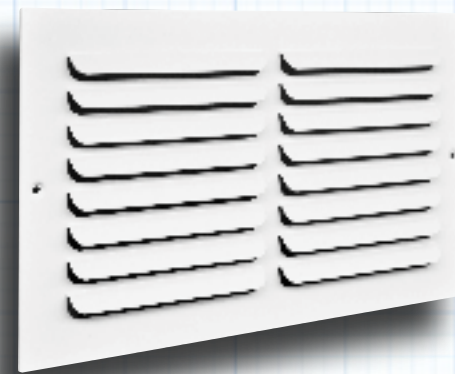

Model 174
Stamped Return Grille
Fixed Curved Blade

Compare to:	170	173
Hart & Cooley	672	650
Shoemaker	1050	1033
USAire	1400	--
Continental	G25	G35
Lima	60GH	63GH
Airmate	170	173

Features

- Stamped steel construction
- Stamped aluminum construction (Model 170 Only)
- Available in 1/2" and 1/3" blade spacing
- Countersunk screw holes
- Pristine white powder coat finish
- Optional non-scuff textured brown finish on 170 models

Finishes

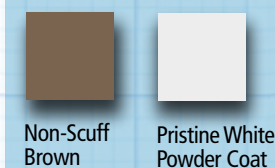

Product Detail

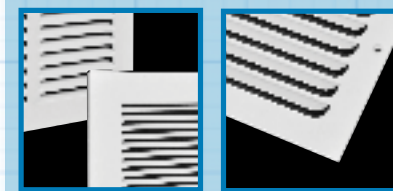

Available in either 1/2" or 1/3" Blade Spacing
Unique curved blade design on Model 174

170 / 173 / 174 SERIES STOCKING SIZES

Height (IN)	WIDTH (IN)															
	6	8	10	12	14	16	18	20	22	24	25	26	28	30	36	40
2								0		0					0	
4	0	0/3	0/3	0/3	0/3	0	0	0/3		0				0/3	0	
6	0/3	0/3	0/3	0/3	0/3	0/3	0/3	0/3	0/3	0/3				0/3/4	0/3	0
8		0/3	0/3	0/3	0/3/4	0/3	0/3	0/3	0/3	0/3/4				0/3/4	0/3	
10			0/3/4	0/3	0/3	0/3	0/3	0/3	0/3	0/3				0/3	0/3	
12			0/3	0/3/4	0/3	0/3	0/3	0/3	0/3	0	0/3/4	0	0	0/3	0	
14		0/4	0	0	0/3/4	0/3	0/3	0/3	0/3	0	0/3	0	0	0/3	0	
16		0		0	0/3	0/3/4	0/3	0/3	0/3	0/3	0	0	0	0/3/4	0	
18				0	3		0/3/4	0/3	0/3	0/3	0	0	0	0/3	0	
20			0	0/3	0/3	0/3	0	0/3/4	0/3	0/3	0	0		0/3/4	0	0
22																
24		0	0	0/3	0/3	0/3	0	0/3	0/3	0/3				0/3	0	
25						0/3		0/3	0/3		0			0		
30		0	0	0/3	0	0/3	0	0/3	0/3	0/3				0/3	0	
32																
36			0	0	0	0	0	0	0	0					0/3	



Model 170 12 x 12

Model 170 / 173

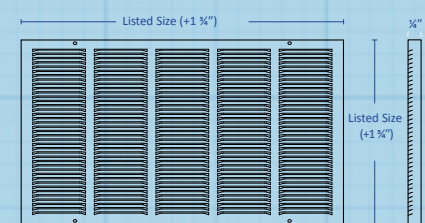

NOTE: Model 170 shown. All dimensions are typical for 170 and 173 Series.

Model 174

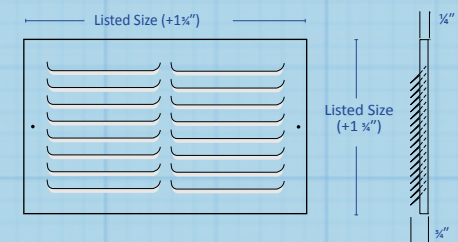

KEY: 0 = 170 3 = 173 4 = 174

170 Series Options

Whether large or small, we have the right grille for the job. Screw-hole placement varies according to typical industry standards.

NOTE: On Models 170 08x04, 10x10, 12x12, 14x10 and 14x14 we offer a 2-hole or 4-hole configuration.

To specify 4-hole when ordering use: 170 14x14-4

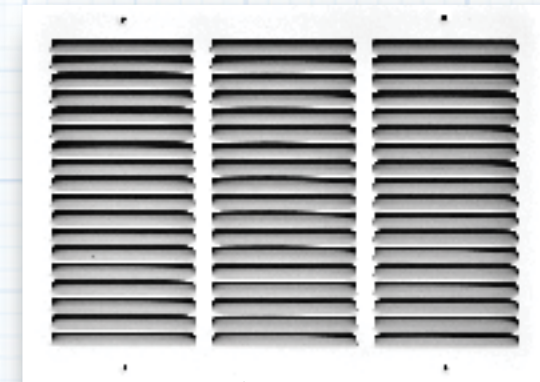

Model 170 20 x 16 -4



Model 170 16 x 20 - 4 Hole

Model Number Specifications

A 170 B L 18 x 08-4

- Material**
Blank = Steel
A = Aluminum (Model 170 Only)
- Stamped Return Air Grille**
- Blade Style**
0 = Model 170 - 1/2" Blade Spacing
3 = Model 173 - 1/3" Blade Spacing
4 = Model 174 - Curved Blade
- Mounting Holes**
Blank = Standard 2 Holes
4 = 4 Mounting Holes (Model 170 Only)
- Grille Height**
- Grille Width**
- Finish**
Blank = Pristine White (Model 170 Only)
B = Non-Scuff Brown (Model 170 Only)
BL = Black (Model 170 Only)

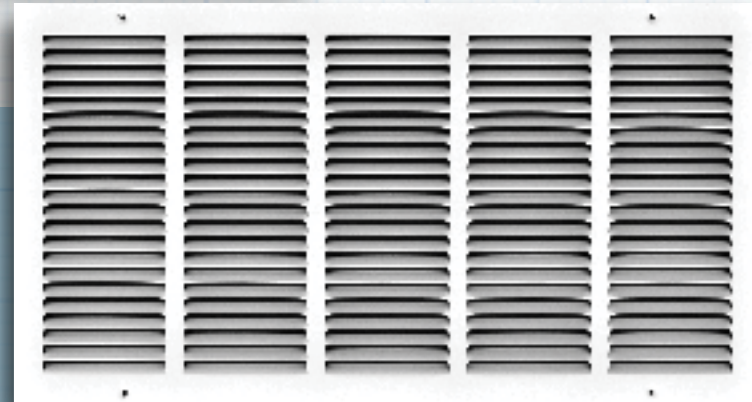

190/194 Series

Different home heating and air-conditioning designs utilize a variety of filter placement strategies. Most new homes in the "sunbelt states" choose to use a filter grille design.

As with everything that TRUaire makes, we offer a wide variety of designs to fit virtually every residential application; different fin spacing, different filter thicknesses, and different door designs. One look at the Comparison Chart, and it becomes clear that no one offers the variety that we do.



Model 190 Fixed face 1/2" blade design

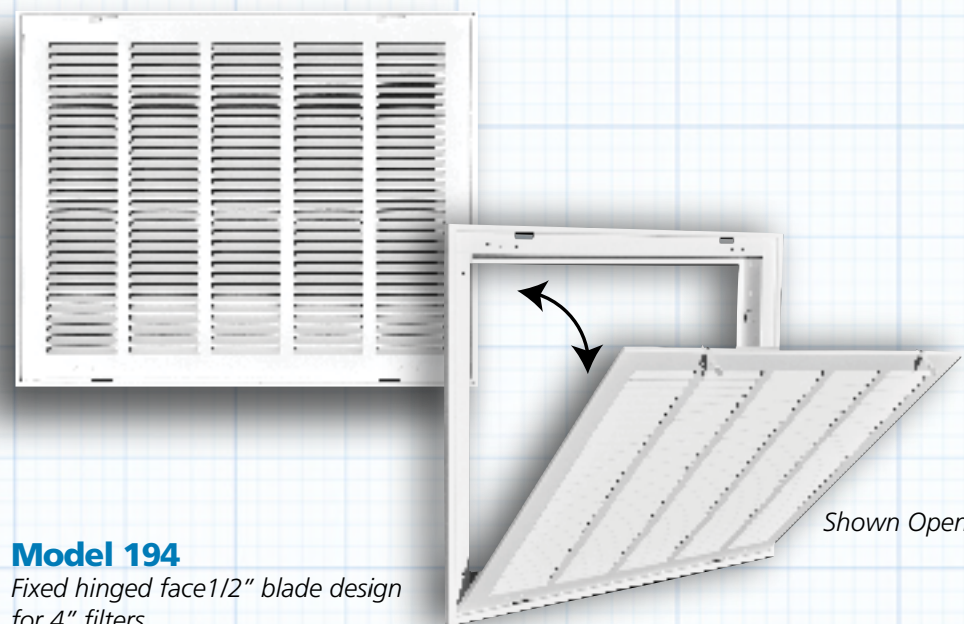

Model 194 Fixed hinged face 1/2" blade design for 4" filters

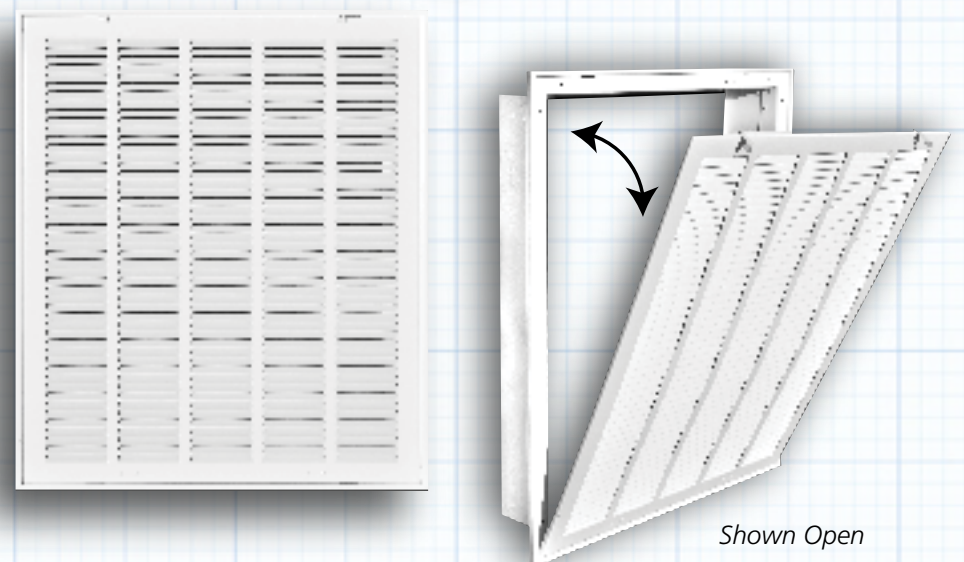

Compare to: 190 194

Hart & Cooley	--	--
Shoemaker	--	FG-4
USAire	--	--
Continental	--	--
Lima	--	--
Airmate	--	--

Features

- Steel construction
- 1/2" blade spacing
- Fixed hinge face
- 190 Series accepts 1" filters
- 194 Series accepts 4" deep filters
- SmoothGlide finger latches
- Pristine white powder coat finish

NOTE: Filters are not included with return air filter grilles.

Product Detail

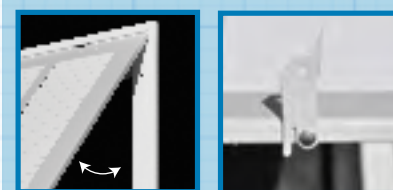

Fixed face design suggested for sidewall applications
SmoothGlide latch for increased durability and ease of use

190 / 194 SERIES STOCKING SIZES

Height (IN)	WIDTH (IN)																
	8	10	12	14	16	18	20	22	24	25	26	29	30	32	36	40	50
6		0					0		0				0				
8	0			0			0		0				0		0		
10		0		0	0		0		0				0	0	0	0	
12			0			0	0		0	0			0		0		
14				0	0		0		0	0	0		0		0		
16		0			0		0		0	0	0		0		0		
18			0			0	0		0				0		0		
20		0	0	0	0	0	0		0	0			0		0	0	0
22								0				0					
24		0	0	0	0	0	0		0				0		0		
25				0	0		0 / 4			0				0			
26				0													
29								0									
30			0	0	0	0	0		0				0		0		
32										0							
36			0	0	0	0	0		0						0		
40																	
50																	



Model 190 16" x 24"

KEY: 0 = 190 4 = 194

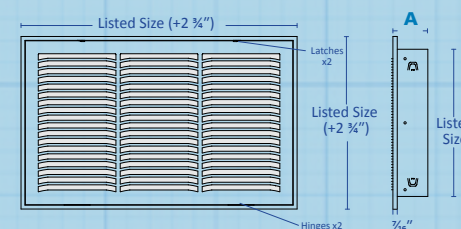

MODEL	A
190	1 3/4"
194	4 11/16"

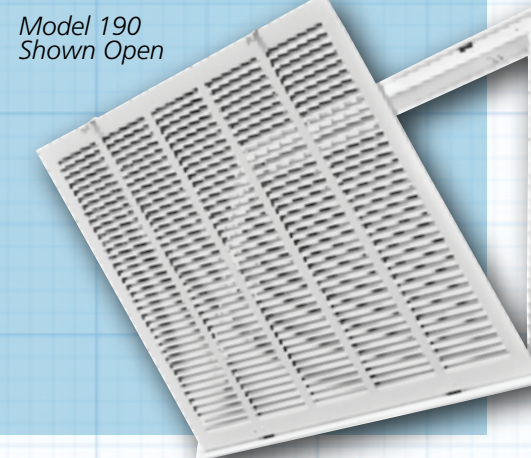

Model 190 Shown Open

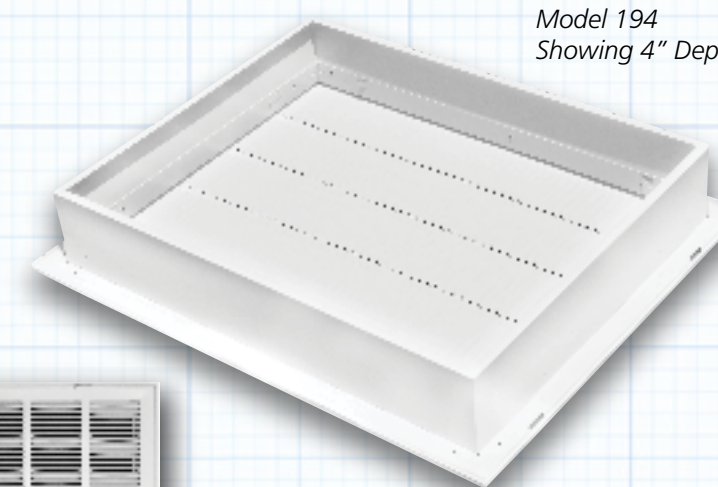

Model 194 Showing 4" Depth



Model 190 24" x 24"

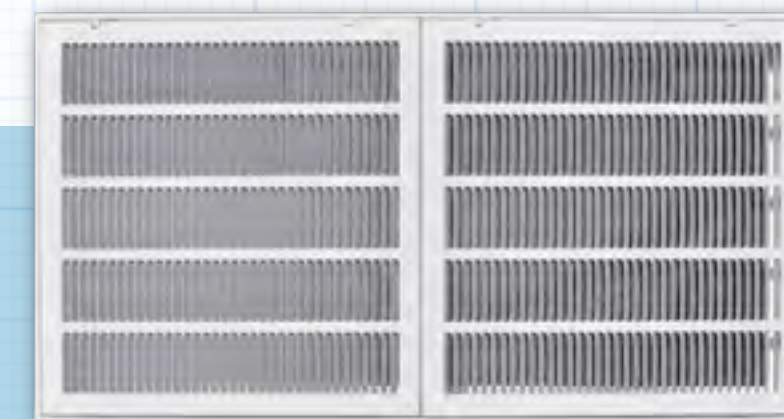

Model 190 40" x 20"

Model Number Specifications

190 18 x 08

Stamped Return Air Grille
Blade Style & Filter Depth
0 = 1/2" Blade Spacing • 1" Deep
4 = 1/2" Blade Spacing • 4" Deep

Grille Height
Grille Width
Face Options
Blank = Fixed Hinge Face
RF = Hinged Removable Face

190RF/192RF/193RF Series

Different home heating and air-conditioning designs utilize a variety of filter placement strategies. Most new homes in the "sunbelt states" choose to use a filter grille design.

As with everything that TRUaire makes, we offer a wide variety of designs to fit virtually every residential application; different fin spacing, different filter thicknesses, and different door designs. One look at the Comparison Chart, and it becomes clear that no one offers the variety that we do.



Model 190RF

Sidewall Filter Grille • Removable face
1/2" blade design

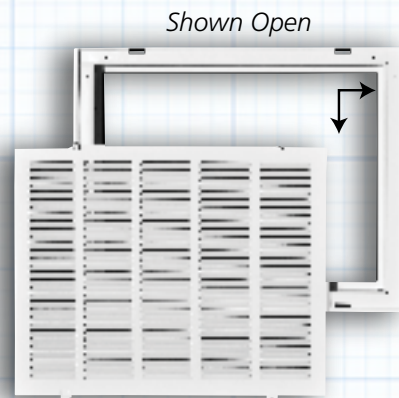

Model 192RF

Sidewall Filter Grille • Removable face
1/2" blade design for 2" filters

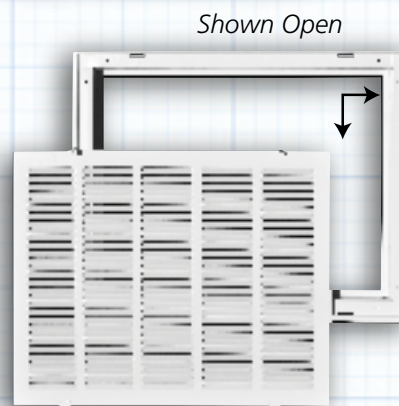

Model 193RF

Sidewall Filter Grille • Removable face
1/3" blade design for 1" filters

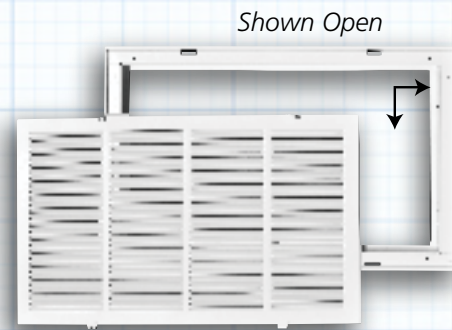

Compare to:	190RF	192RF	193RF
Hart & Cooley	673	--	659
Shoemaker	FG	FG-2	--
USAire	1410F	--	--
Continental	FG-2	--	--
Lima	60GHFF	--	--
Airmate	170FF	--	--

Features

- Steel construction
- Available in 1/2" and 1/3" blade spacing
- Removable face
- 190 and 193 Series accepts 1" filters
- 192 Series accepts 2" deep filters
- SmoothGlide finger latches
- Pristine white powder coat finish

NOTE: Filters are not included with return air filter grilles.

Product Detail

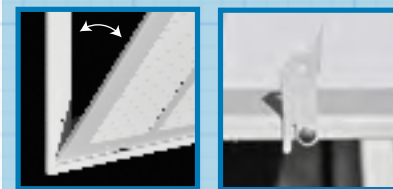

Removable face design suggested for sidewall applications
SmoothGlide latch for increased durability and ease of use

NOTE: Model 190RF shown. All dimensions are typical for 190RF, 192RF and 193RF.

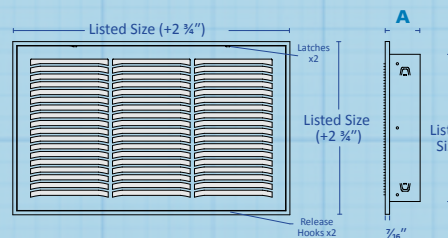

MODEL	A
190RF	1 3/4"
192RF	2 7/8"
193RF	1 3/4"

190RF / 192RF / 193RF SERIES STOCKING SIZES

Height (IN)	WIDTH (IN)															
	8	10	12	14	16	18	20	24	25	28	30	32	36	40	50	
6		0		0	0			0								
8			0	0				0/2								
10		0/3			0		0/3				0/2					
12			0/2/3		0/2	0/2	0/3	0/2/3			0/2					
14				0/2/3			0/2/3	0/2/3	0/2/3	0	0/2/3		0/2			
16					0/3		0/2/3	0/16/2	0/3		0/2		2			
18			0			0/2	0				0/2		0/2			
20		0	0/2/3	0	0	0/2/3	0/2	0/2			0/2/3		0	0	0	
24			0/2	0/2/3	0	0	0/2	0/2/3			0/2/3		0			
25				0/2/3	0/2	0	0/2/3		0/3			0				
26																
30		0	0	0	0	0	0/2/3	0/2/3			0/3					
32							0			0						
36			0		0	0	0	0								
40																
36			0	0	0	0	0			0						
40																
50																

KEY: 0 = 190RF 2 = 192RF 3 = 193RF



Model 190RF 16" x 24"



Model 190RF 12" x 12"



Model 190RF 30" x 14"

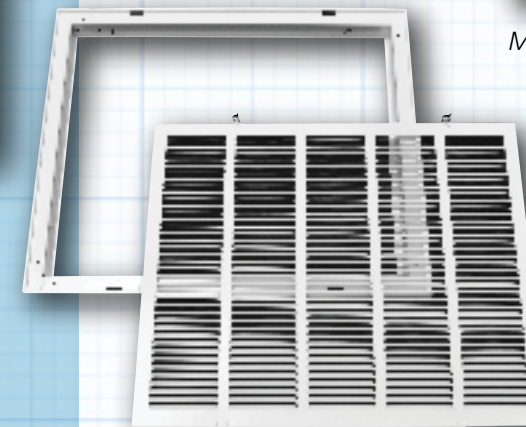

Model 190RF Shown Open

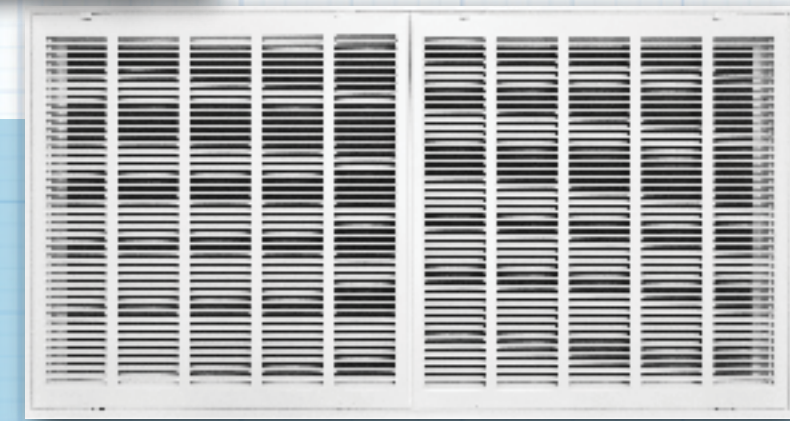

Model 190RF 40" x 20"

Model Number Specifications

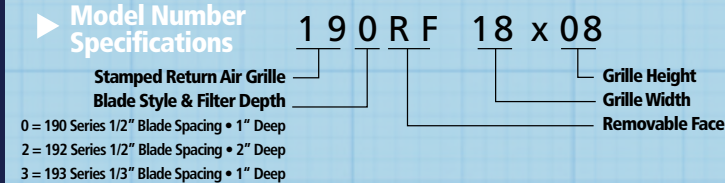

270 Series

When choosing return air grilles, whether filter grille or straight return air, the most economical choice is stamped steel every time. But for a few dollars more, the Fixed Bar models provide the luxury of ruggedness and appearance.

Each heavy gauge bar is individually set at 75 degrees from the face, and spaced 3/4" apart. There's nothing "flimsy" about this grille. It is rock-solid, individually welded, and looks fantastic!



Model 270

Fixed Bar Return Air Grille

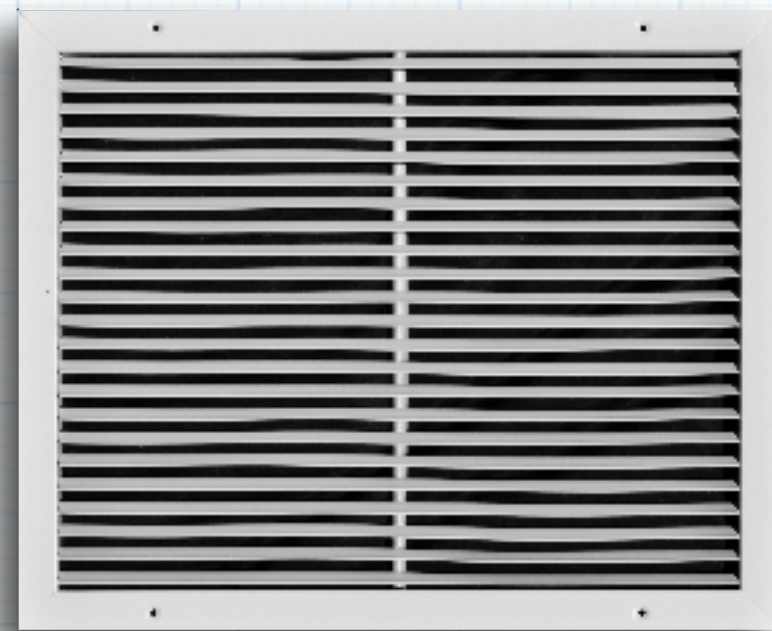

Compare to:	270
Hart & Cooley	94A
Shoemaker	--
USAire	SRH
Continental	FBG40
Lima	S90H
Airmate	280

Features

- Steel construction
- 3/4" blade spacing
- 75° blade pitch from grille face
- Countersunk screw holes on 270 Series
- Fixed hinge face on all return air filter grilles
- Pristine white powder coat finish
- Optional Opposed Blade Damper

Product Detail



Blades at 75 degrees from face

270 SERIES STOCKING SIZES AND CARTON QUANTITY CHART

Height (IN)	WIDTH (IN)																								
	4	6	8	10	12	14	16	17	18	20	22	24	25	26	28	30	32	34	36	38	40	44	48	50	
4				20	20	20	20					10				10			10						
6		20	20	20	20	20	20		10	10		10		5	5	10			10						
8			20	20	20	20	20		10	10		10		5	5	10			10						
10					20	20	20		10	10	10		5	5	5	10			10						
12					10	10	10		10	10		10		5		5			5					5	
14					20	10	10		5	10		5	5		5	5	X		5	5					
16						10	10		10	5		5	5		5	5		5	5		5	?			1
18				10					5	5		5	5		5	5		5	5						
20				10		10			5	5		5	5		5	5		5	5		5				
22											5								5						
24	10				10	5	5			5		5				5			5					1	
25										5			5												
26																									
30						5				5		5				5			5						
36									5																
40										5															

270 Series	
MODEL	A
270	13/16"
270-O	2 1/4"

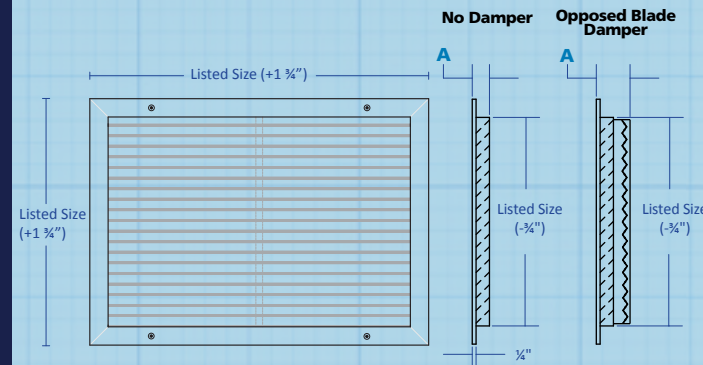

Model 270 20" x 16"

Model 270 16" x 16"



Model 270 14" x 20"

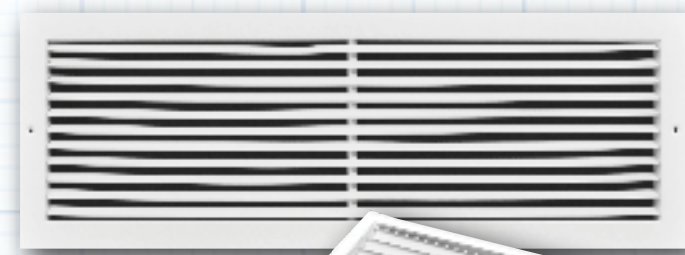

Model 270 26" x 08"

► **Model Number Specifications**

270 - O **18 x 08**

Fixed Bar Return Air Grille Grille Height
 Damper Option Grille Width
 Blank = No Damper
 O = Opposed Blade Damper

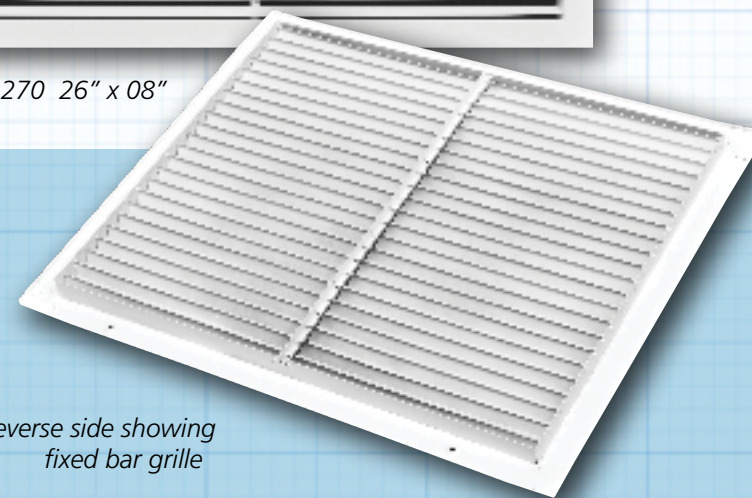

Reverse side showing fixed bar grille

290/292/294 Series

When choosing return air grilles, whether filter grille or straight return air, the most economical choice is stamped steel every time. But for a few dollars more, the Fixed Bar models provide the luxury of ruggedness and appearance.

Each heavy gauge bar is individually set at 75 degrees from the face, and spaced 3/4" apart. There's nothing "flimsy" about this grille. It is rock-solid, individually welded, and looks fantastic!

Model 290

Fixed Bar Return Air Filter Grille

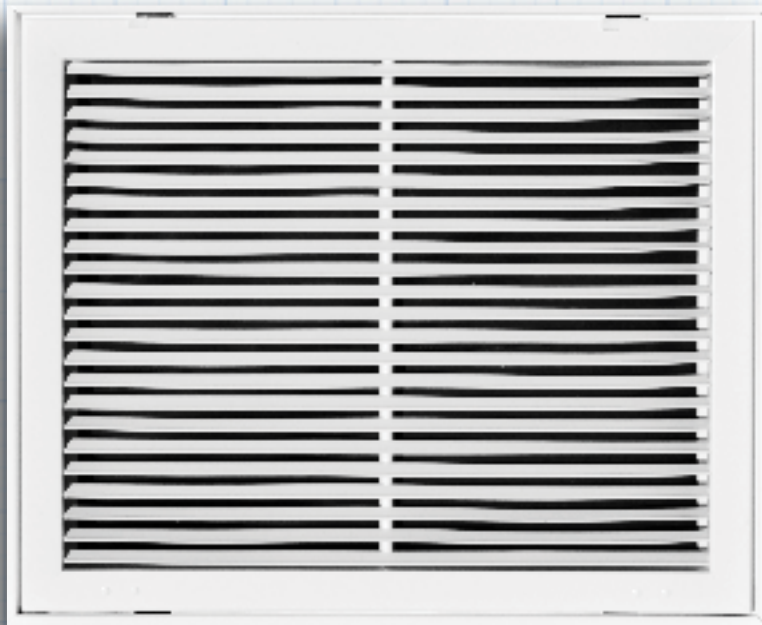

Compare to:	290
Hart & Cooley	96AFB
Shoemaker	920FG-2
USAire	SRHF
Continental	FBFG
Lima	S90HFF
Airmate	280FF

Features

- Steel construction
- 3/4" blade spacing
- 75° blade pitch from grille face
- 290 Series accepts 1" deep filters
- 292 Series accepts 2" deep filters
- 294 Series accepts 4" deep filters
- Fixed hinge face
- Pristine white powder coat finish

NOTE: Filters are not included with return air filter grilles.

Product Detail



Blades at 75 degrees from face

SmoothGlide Latch for increased durability and ease of use

290 / 292 / 294 SERIES STOCKING SIZES AND CARTON QUANTITIES

Height (IN)	WIDTH (IN)													
	10	12	14	16	18	20	22	24	25	30	32	36	40	50
6				0		0		0		0		0		
8						0				0				
10	0 / 2	0		0		0		0		0 / 2				
12		0 / 2			0	0		0 / 2	0	0 / 2		0		
14			0 / 2			0		0 / 2	0	0 / 2 / 4		0		
16				0 / 2		0		0 / 2	0	0 / 2		0 / 2 / 4		
18					0	0		0 / 2		0		0		
20		0	0 / 2			0 / 2		0 / 2	0	0 / 2 / 4		0 / 2	0	0 / 2
22							0							
24		0	0		0	0 / 2		0 / 2		0 / 2		0 / 2		
25			0			0			0		0			
30		0 / 2	0	0	0	0		0						
32									0					
36										0		0		
40														
50														



Model 290 14" x 20"

KEY: 0 = 290 2 = 292 4 = 294

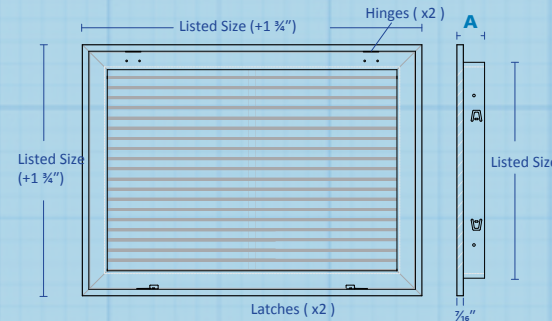

MODEL	A
290	1 7/8"
292	2 7/8"
294	4 11/16"

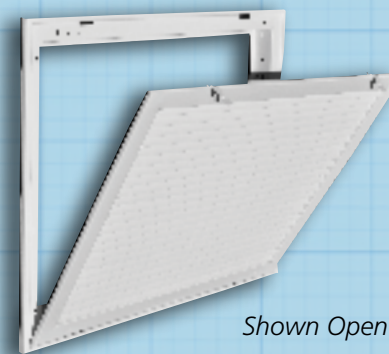

Shown Open



Model 290 accepts 1" filters

Model 290 16" x 16"

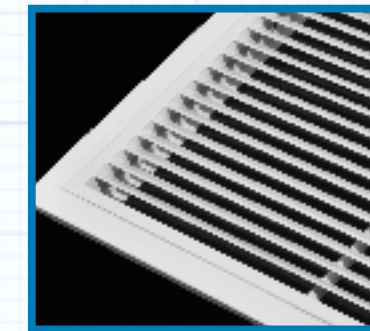

3/4 inch blade spacing



Model 290 20" x 16"

Model Number Specifications

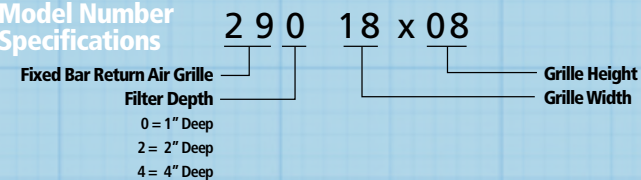

A170 Series

Stamped aluminum return grilles represent the most economical way to provide return air. These high quality stamped aluminum models are not only available in a wide variety of sizes, but blade design, and blade spacing as well. Although most commonly found in a pristine white powder-coat finish, the model A170 is also available in a brown finish.



Model A170

Stamped Return Grille
1/2" Blade Spacing



Compare to:

A170	A170
Hart & Cooley	672
Shoemaker	1050
USAire	1400
Continental	G25
Lima	60GH
Airmate	170

Features

- Stamped aluminum construction
- Available in 1/2" blade spacing
- Countersunk screw holes
- Pristine white powder coat finish
- Optional non-scuff textured brown finish on A170 models

Product Detail

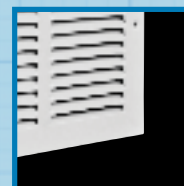

Available in 1/2" Blade Spacing

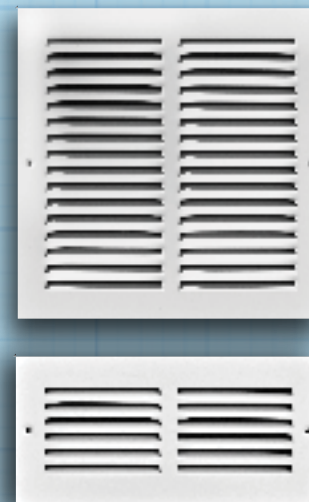
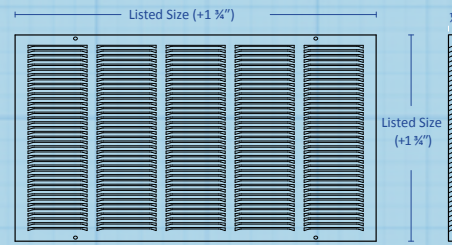

A170 Series Options

Whether large or small, we have the right grille for the job. Screw-hole placement varies according to typical industry standards.

A170 SERIES STOCKING SIZES

Height (IN)	WIDTH (IN)			
	6	8	10	12
6	20			20
8		20		20
10			20	20
12				20
14				20

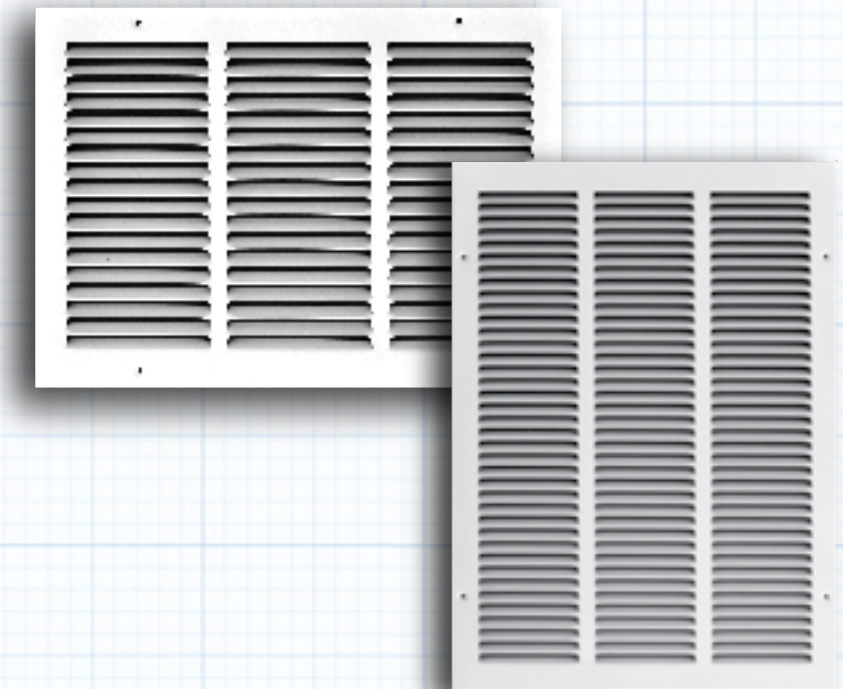

Model Number Specifications

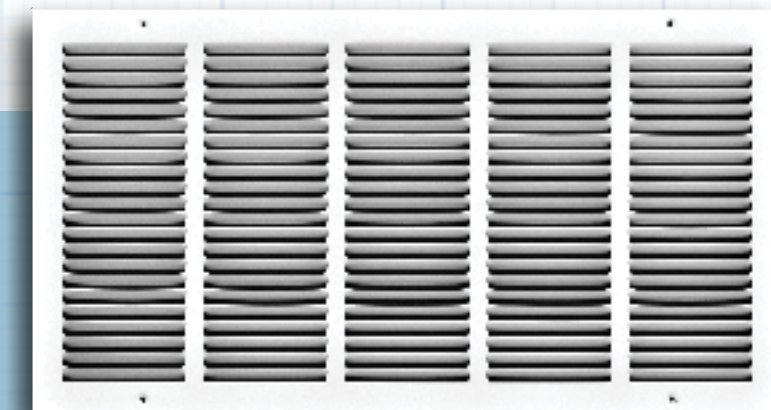
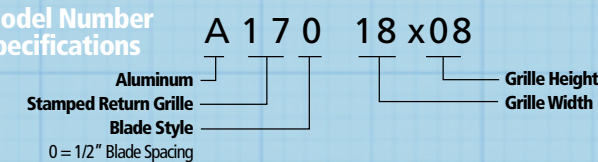

A270 Series

The top-of-the-line Return Air Grille is bar-type. And the best bar-type Return Air Grille is made of aluminum. Lightweight, rust resistant, and durable; Truair's A270 Return Air Grille is the best of the best for residential return air applications.

Each aluminum fixed blade is set at 60 degrees from face and 3/4" apart. Finished in our pristine white powder-coat, this is a tough act to follow!



Model A270

Fixed Bar Return Air Grille

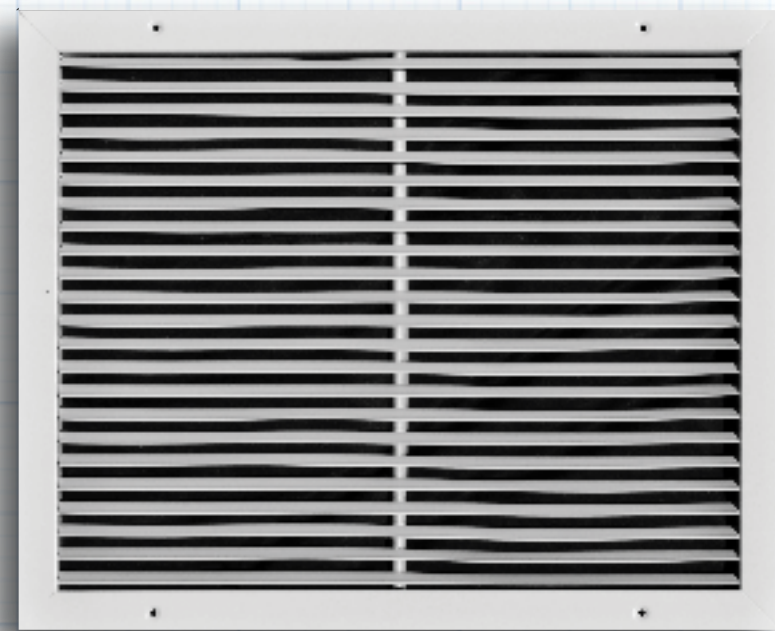

Compare to:	A270
Hart & Cooley	RH45
Shoemaker	905
USAire	RH
Continental	AFBG40
Lima	ALS90
Airmate	E280

Features

- Extruded aluminum construction
- 3/4" blade spacing
- 60° blade pitch from grille face
- Countersunk screw holes
- Pristine white powder coat finish
- Optional 45° blade pitch
- Optional opposed blade damper

Product Detail



Blades at 60 degrees from face

A270 SERIES STOCKING SIZES AND CARTON QUANTITY CHART

Height (IN)	WIDTH (IN)																	
	6	8	10	12	14	16	18	20	22	24	25	28	30	36	40	42	46	48
4	20	20								10								
6	20	20	20	20	20	20	10	10		10			10	10	1			
8		20	20	20	20	20	10	10		10			10					
10			20	20	20	20	10	10	10	10			10	10				
12				10		10	10	10		10		5	5	5				
14					10		5	10		5	5	5	5					
16								5		5	5	5	5					1
18					10	5	5	5		5			5	5		1		
20				10	10	5		5		5	5		5					
22									5									
24			10	10	5	5	5	5		5			5					
25					5	5		5										
30					5		5											
36					5		5			5								1
42	1																	

A270 Series	
MODEL	A
A270	1"
A270-O	2 7/16"

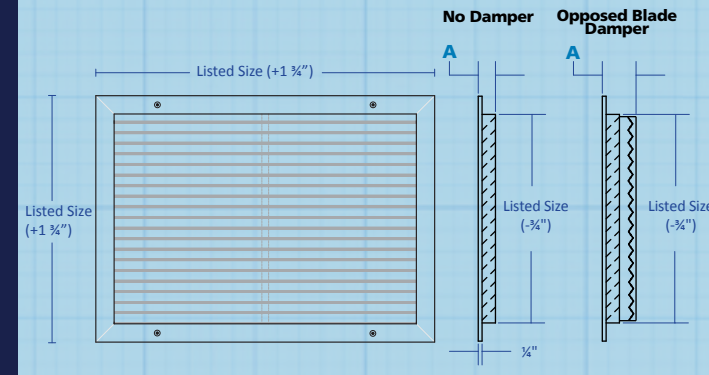

Shown in Aluminum Finish

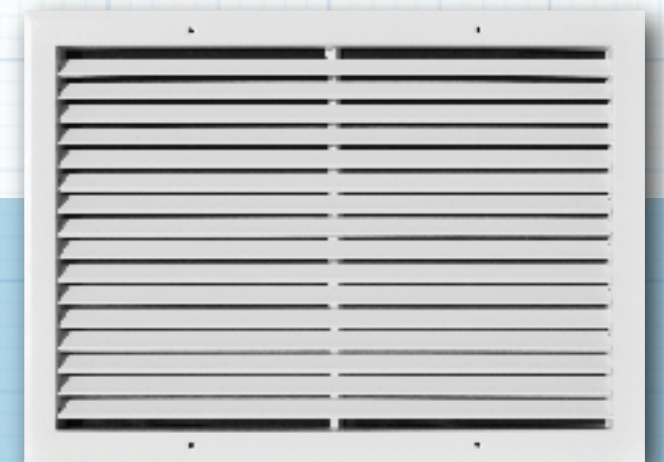

Model Number Specifications

A 270 - 45 - O 18 x 08

Aluminum Fixed Bar Return Grille
Blade Pitch: Blank = 30°, 45 = 45°

Grille Height: 18
Grille Width: 08
Damper Option: Blank = No Damper, O = Opposed Blade Damper

A290 Series

The top-of-the-line Return Air Grille is bar-type. And the best bar-type Return Air Grille is made of aluminum. Lightweight, rust resistant, and durable; Truair's A290 Return Air Filter Grille is the best of the best for residential return air applications.

Each aluminum fixed blade is set at 60 degrees from face and 3/4" apart. Finished in our pristine white powder-coat, this is a tough act to follow!



Model A290

Aluminum Fixed Bar Return Air Filter Grille



Easy-to-open slide latch

Compare to:	A290
Hart & Cooley	RHF45
Shoemaker	--
USAire	RHF
Continental	--
Lima	ALS90HFF
Airmate	E289FF

Features

- Extruded aluminum construction
- 3/4" blade spacing
- 60° blade pitch from grille face
- Accepts 1" deep filters
- Fixed hinge or removable face
- Pristine white powder coat finish
- Optional 45° blade pitch

NOTE: Filters are not included with return air filter grilles.

Product Detail



Blades at 60 degrees from face Detail view of slide latch from face

A290 SERIES STOCKING SIZES AND CARTON QUANTITIES

Height (IN)	WIDTH (IN)																
	8	10	12	14	16	18	20	22	24	25	28	30	32	36	40	44	48
6		1	1	1					1								
8	1		1	1					1								
10		1		1	1				1			1	1				
12			1		1	1			1			1	1		1		
14				1		1	1		1	1		1	1		1		
16					1	1	1		1	1		1	1		1		
18			1			1	1		1	1		1	1		1		
20		1	1	1	1	1	1		1	1		1	1	1	1	1	
22								1									
24			1	1	1	1	1		1			1		1			1
25				1	1		1			1							
30			1	1	1	1	1		1			1					
36									1								
40							1										
48									1								

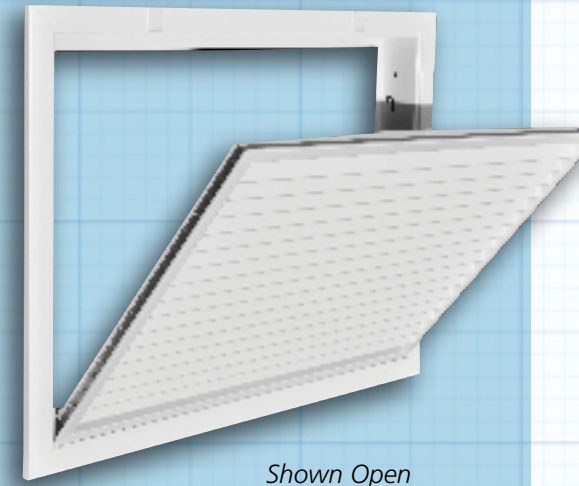
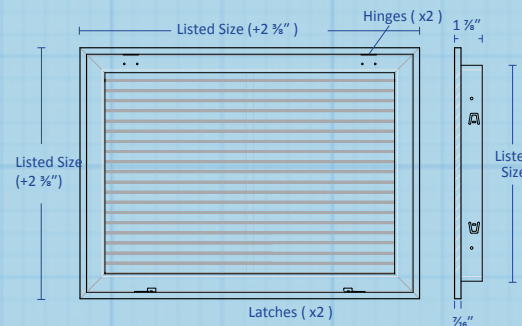

Shown Open

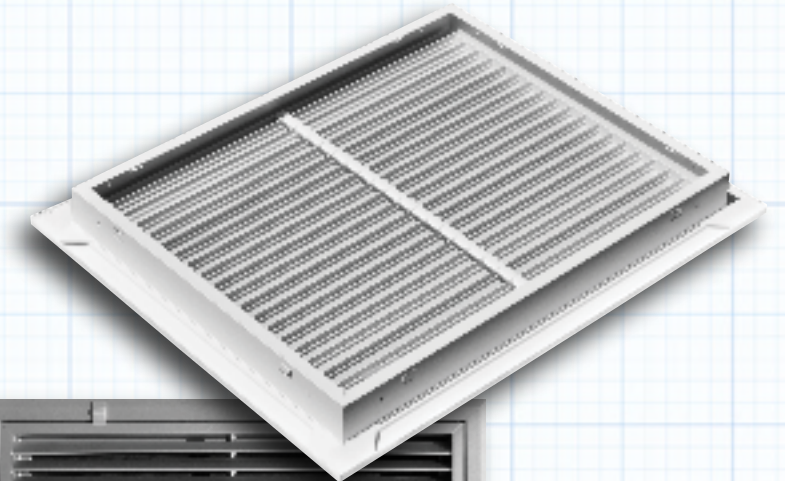

Model A290RF-AL
Shown in Aluminum Finish



Model Number Specifications

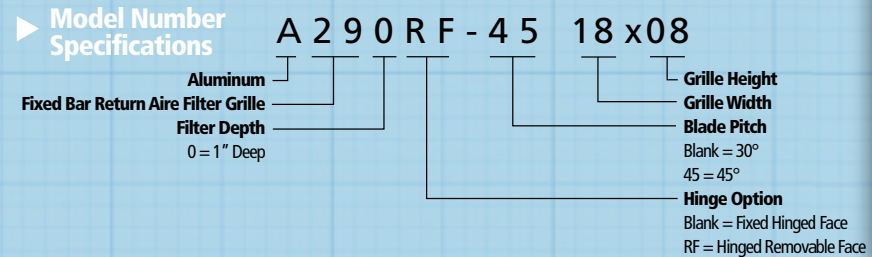

A900 Series

Truair's A900 Series surface mounted grilles feature a clean, crisp architectural appearance and are manufactured to provide strength and durability. The A900 Series comes in either a 1/2" x 1/2" x 1/2" egg crate face or a 51% free area perforated face with aluminum extruded frame that has countersunk mounting holes. The egg crate can be specified in acrylic or aluminum which are constructed with thin, interlocking strips assembled into a square grid pattern.



Model A920

Perforated Face Surface Mount Return Air Grill

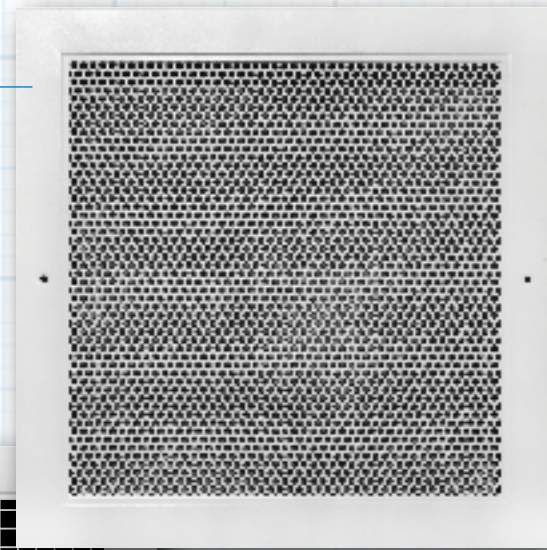

Model A960

Acrylic Egg Crate Surface Mount Return Air Grill

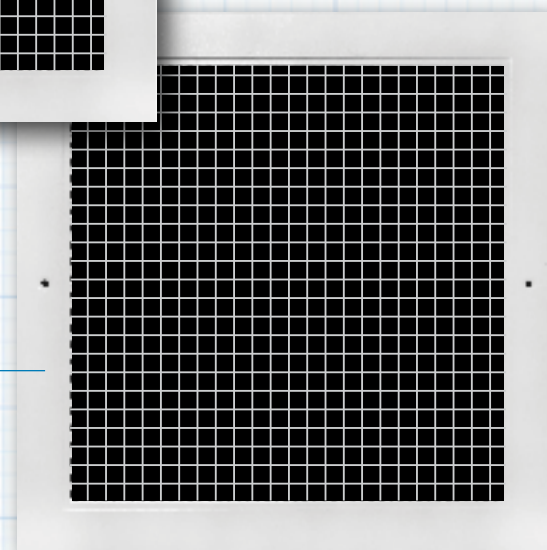

Model A970

Aluminum Egg Crate Surface Mount Return Air Grill

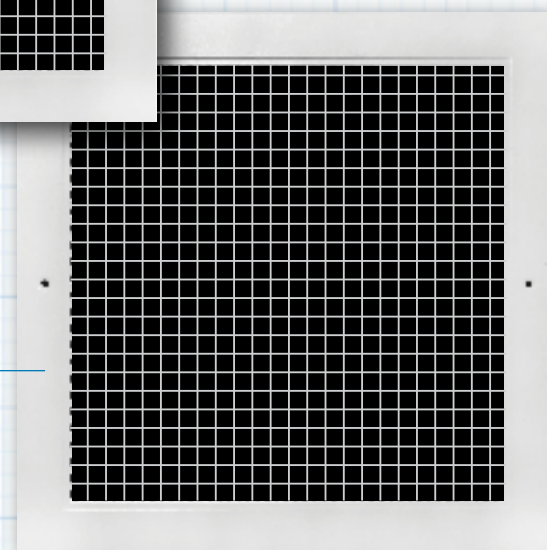

Features

- Extruded aluminum frame construction
- Available in either perforated or egg crate face
- 51% free area perforated
- Acrylic or aluminum 1/2" x 1/2" x 1/2" egg crate
- Countersunk screw holes
- Pristine white powder coat finish

Product Detail

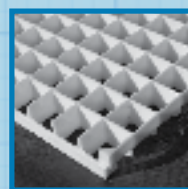

Acrylic Egg Crate

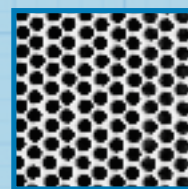

Steel Perforated Face
51% Open Area



Aluminum Egg Crate

Model A920

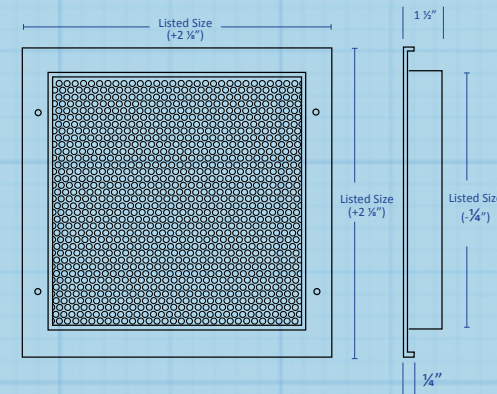

Model A960 / A970

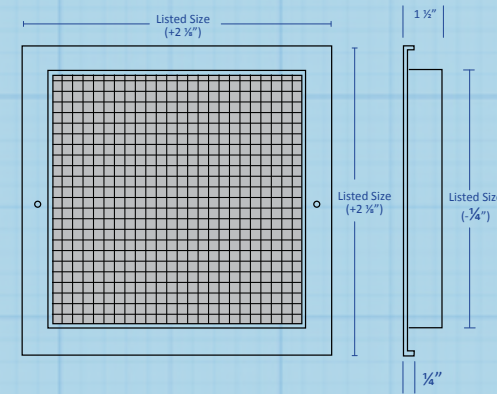

A900 Series Options

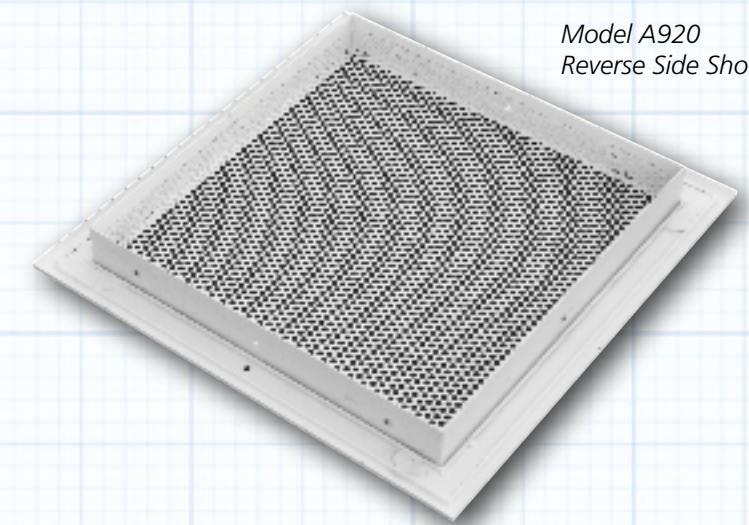

*Model A920
Reverse Side Shown*

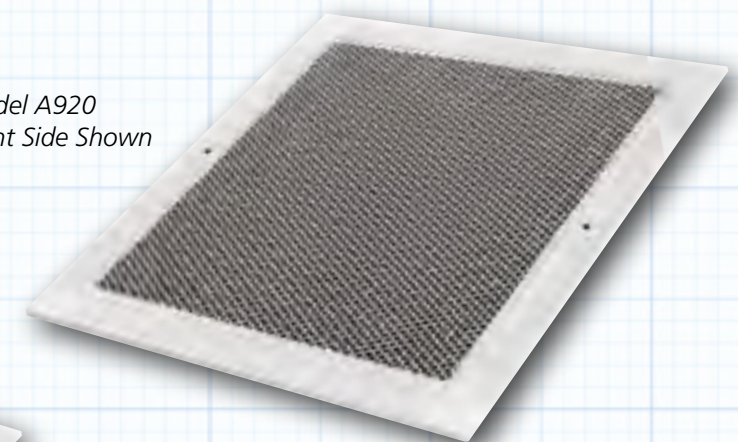

*Model A920
Front Side Shown*

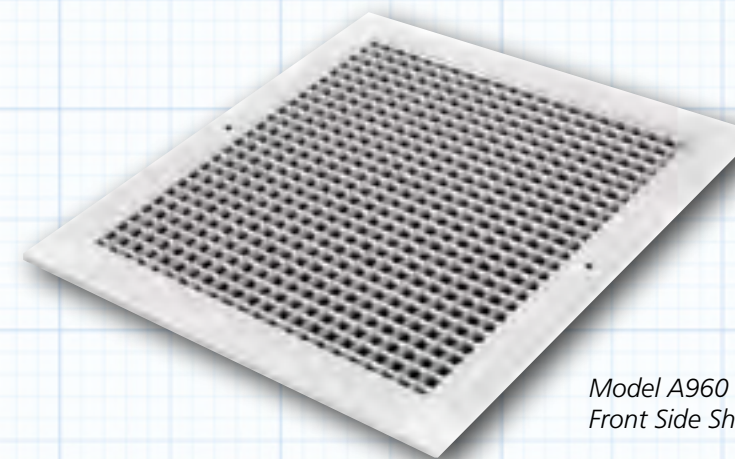

*Model A960
Front Side Shown*

Model Number Specifications

A 9 7 0 - S Q 18 x 08

Egg Crate Grille Material
2 = Steel Perforated
6 = Acrylic
7 = Aluminum

**Grille Height
Grille Width
Square Neck**

1010 / 1020MAS Series

The 1000 Series T-Bar models are designed with budget in mind. These diffusers come with an attractive perforated steel face finished in pristine white powder-coat. The supply model (MAS) includes an air deflector for enhanced air distribution.

These diffusers can be ordered with the universal R6 molded fiberglass back, with a heavy duty steel back and fixed collar or a combination of both the formed steel back, collar, and R6 insulation.

Model 1010MAS / MAR

With universal R6 fiberglass back

Reverse side shown



Model 1020MAS / MAR

With steel back and fixed collar

Reverse side shown

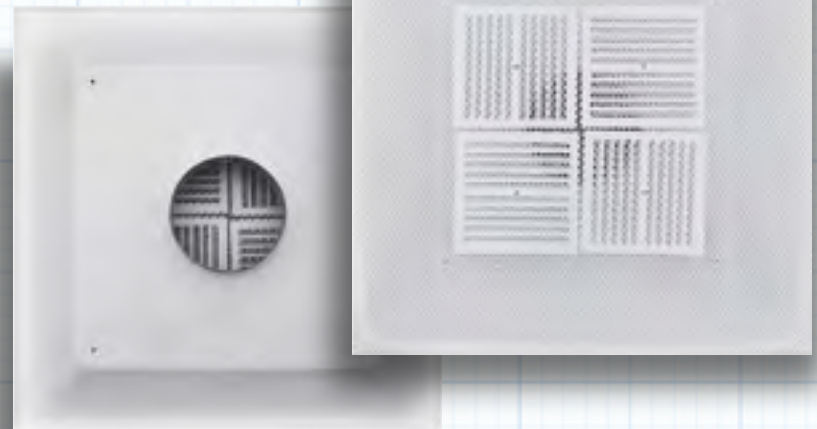

Compare to:	1010
Hart & Cooley	REN/RENPS
Titus	
Shoemaker	110/111
Metal Aire	7300
Price	
Krueger	

Features

- Steel construction
- 51% open free area perforated face
- Seismic support tabs
- (4) Air deflectors on MAS Models
- Molded R6 insulated back on 1010 Models
- Universal cut-in collars on 1010 Models
- TRUaire Super Collar on 1020 Models
- Pristine white powder coat finish
- Optional molded R6 insulated back available on 1020 Models
- Optional butterfly damper
- Optional radial damper

Product Detail

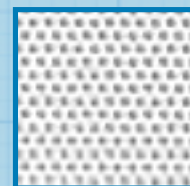

Steel Perforated Face
51% Open Area



Seismic Support Tabs

MODEL 1010
Universal molded R6 fiberglass back

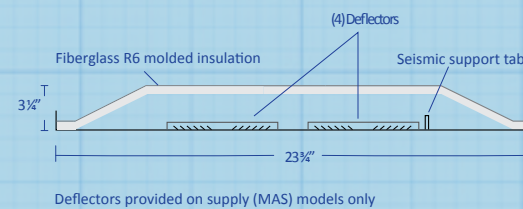

Deflectors provided on supply (MAS) models only

MODEL 1020
Uninsulated: Steel backing with fixed collar

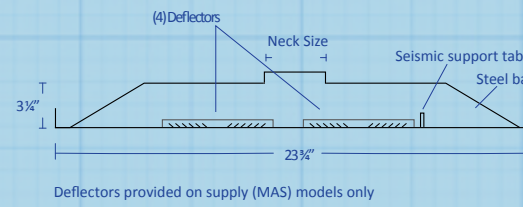

Deflectors provided on supply (MAS) models only

MODEL 1020-INS (Insulated)
Insulated: R6 backing with fixed collar

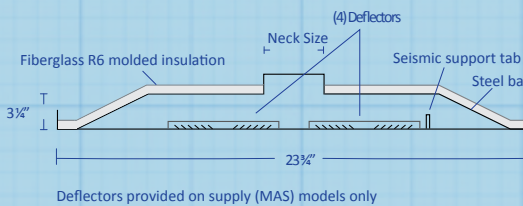

Deflectors provided on supply (MAS) models only

1010 MAS/MAR Options

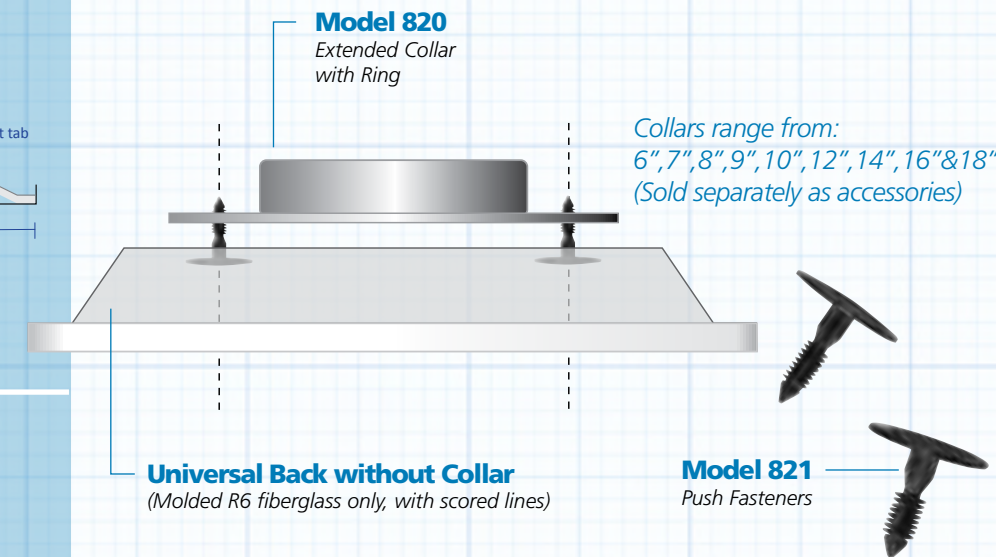

Universal Back without Collar
(Molded R6 fiberglass only, with scored lines)

Model 821
Push Fasteners

1020 MAS/MAR Options

Steel Back - with Collar
(Uninsulated with fixed collar)

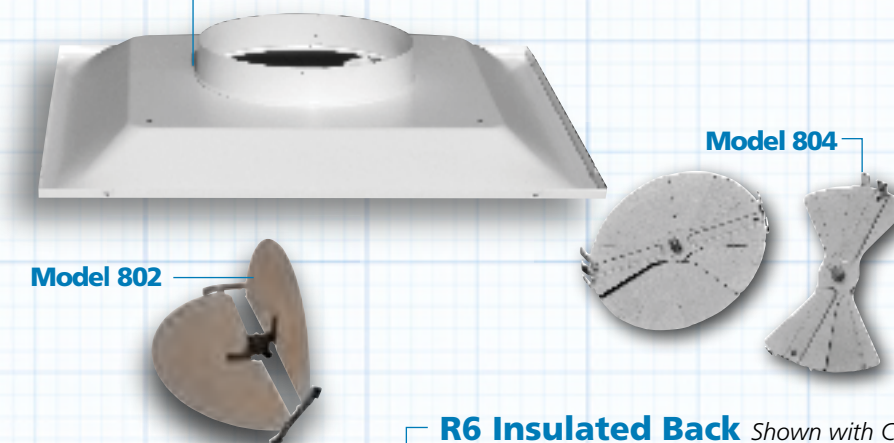

Model 802

Model 804

R6 Insulated Back Shown with Collar
(Insulated with scored lines and fixed collar)

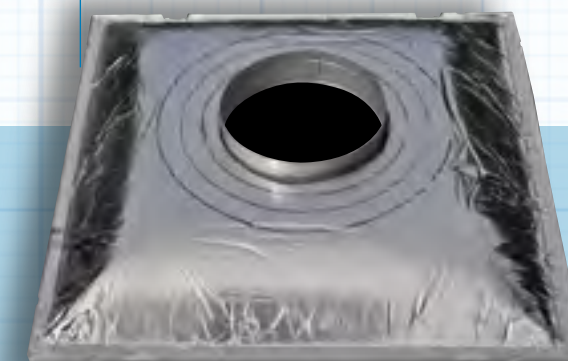

Model Number Specifications

1010MAS/08IN/BD

- T-Bar Perforated Face Diffuser
- Back: 10 = Molded R6 Insulated Universal Back, 20 = Steel Back
- Fixed Face Type: S = Supply with Deflectors, R = Return without Deflectors
- Neck Size (1020 Only): R6 = Steel Back & Molded R6 Insulated Back, 06 = 6"Ø, 08 = 8"Ø, 10 = 10"Ø, 12 = 12"Ø, 14 = 14"Ø
- Damper Option (1020 Only): Blank = No Damper, BD = Butterfly Damper, RAD = Radial Damper
- R6 Insulation Option (1020 Only): Blank = No Molded R6 Insulated Back, IN = Molded R6 Insulated Back

1120S Series

Drawing from our close relationship with contractors who know the industry, these T-Bar Grilles cut installation time by utilizing a unique plenum frame design. The three face designs available are perforated steel, acrylic eggcrate and aluminum eggcrate. These easy to use and ready to go T-Bar Grilles come with or without the 1 1/2" ductboard.

The 1120 perforated model is available as either a Supply Diffuser employing the stamped deflector or return. Each model is also available in full-size T-Bar configurations including half T-Bar and double T-Bar dimensions.

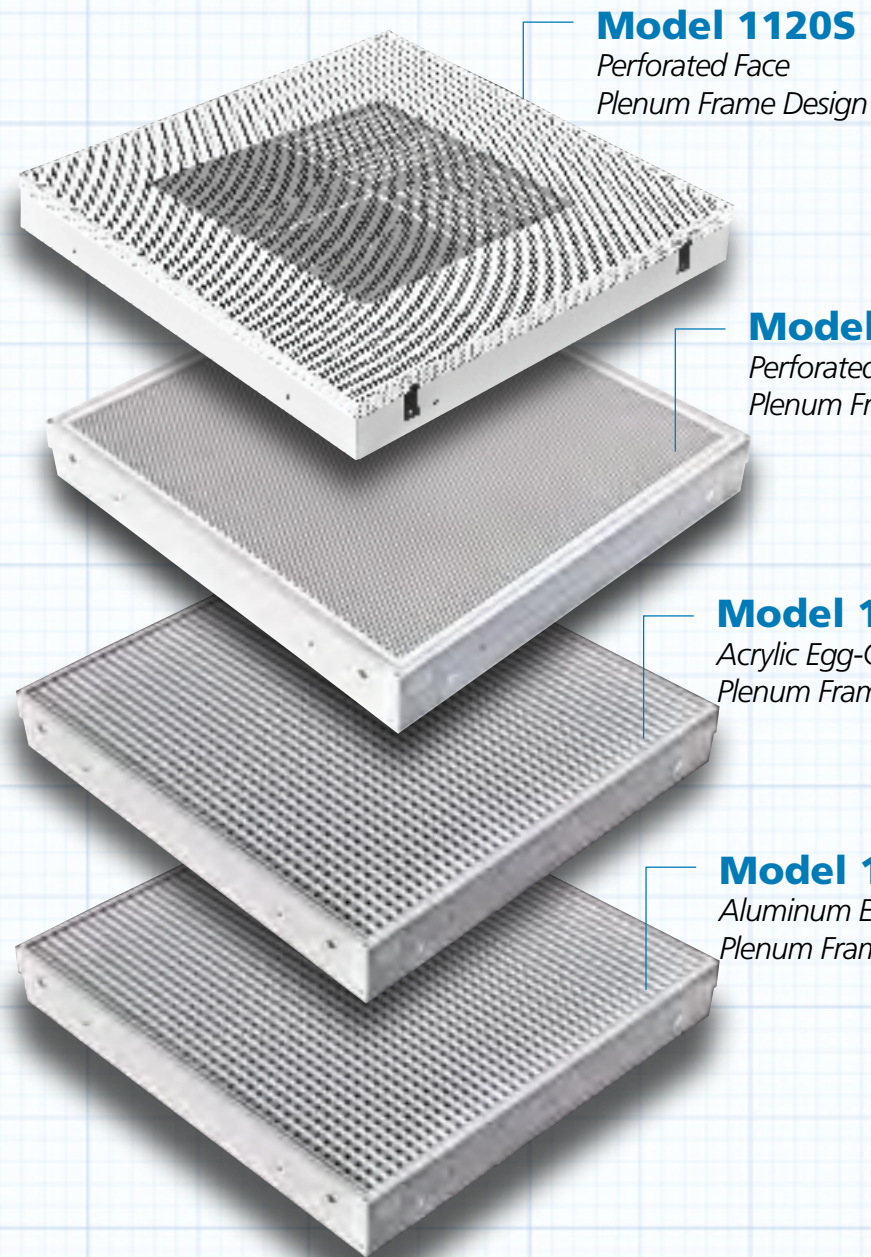

Model 1120S
Perforated Face
Plenum Frame Design

Model 1124R
Perforated Face
Plenum Frame Design

Model 1130
Acrylic Egg-Crate Face
Plenum Frame Design

Model 1140
Aluminum Egg-Crate Face
Plenum Frame Design

Features

- Steel construction
- Perforated or egg crate face
- Perforated face with 51% open free area
- Acrylic or aluminum egg crate
- Plenum frame design
- Available in 3 sizes
- Pristine white powder coat finish
- Optional ductboard back

Product Detail



Plenum box on reverse side



Seismic support tabs

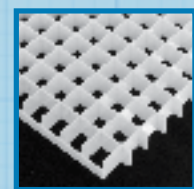

Acrylic Egg Crate

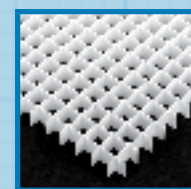

Aluminum Egg Crate

Model 1120

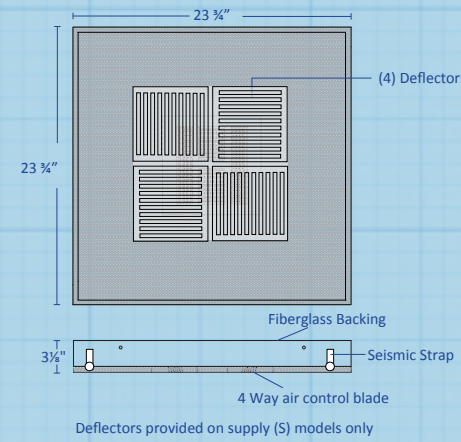

Model 1130 / 1140

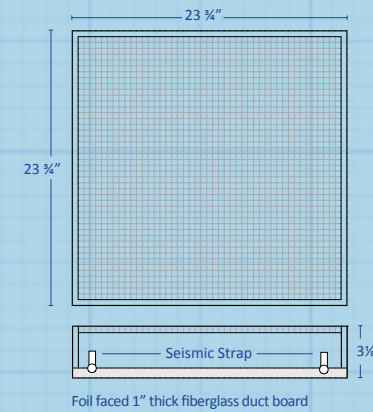

Model 1124R

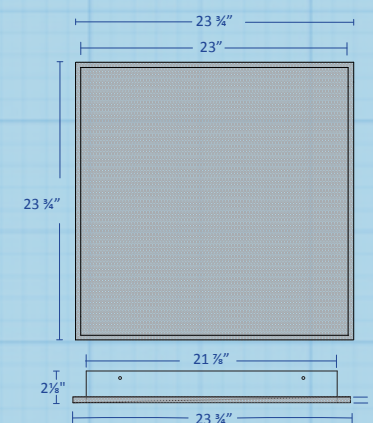

Model Number Specifications

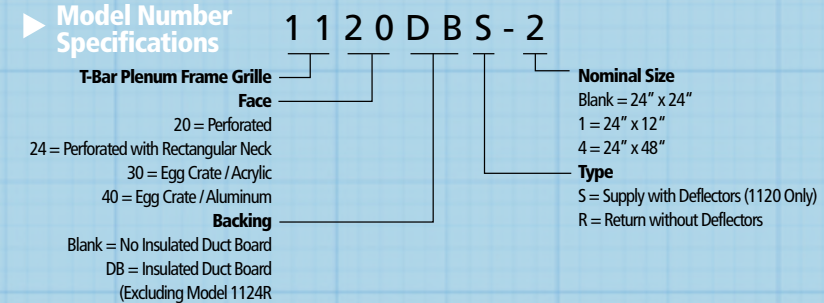

1120S Series Options



Model 1120S
Shown with Supply Deflectors

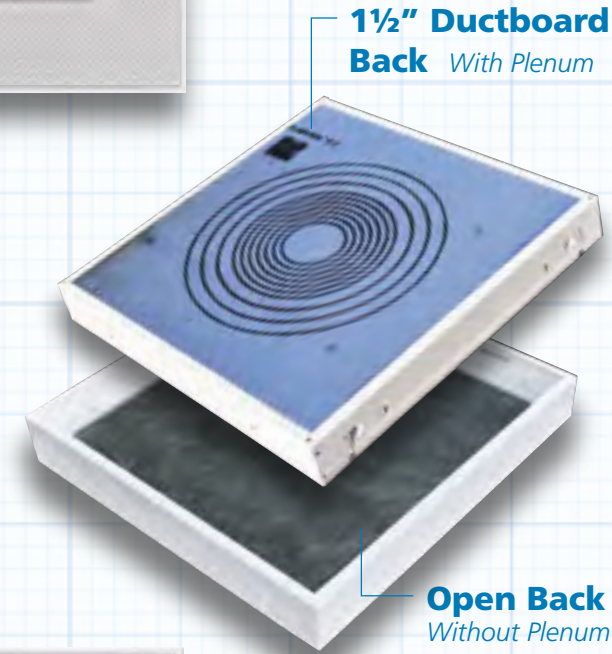

1 1/2" Ductboard Back With Plenum

Open Back Without Plenum

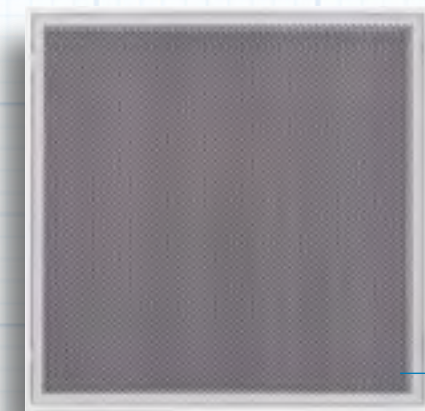

Model 1124R



Detail View showing mitered corner and perforated face with 51% open area.

1400 Series

The 1400 Series is a set of hinged perforated face T-Bar products. Choose from models providing the luxury of high-quality adjustable blades, smooth and even 360° airflow, or the economy of adjustable deflectors. The 1444RG is the perfect match for either Supply Diffuser. Every 1400 Series Diffuser comes standard with the TRUaire Super-Collar and is also available with optional insulation.

Model 1400CB

T-Bar Perforated Curved Blade - Supply Diffuser

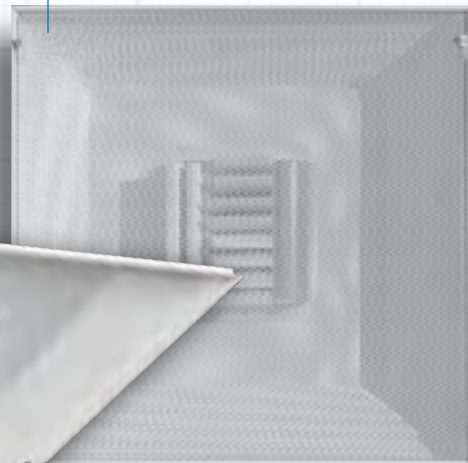

Model 1420AB

T-Bar Perforated Supply Diffuser with Rotating Deflectors

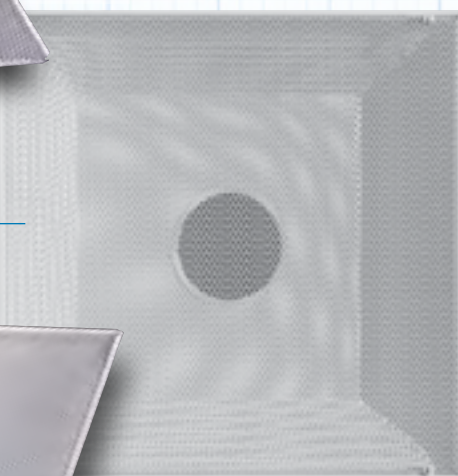

Model 1444RG

T-Bar Perforated Return Grille

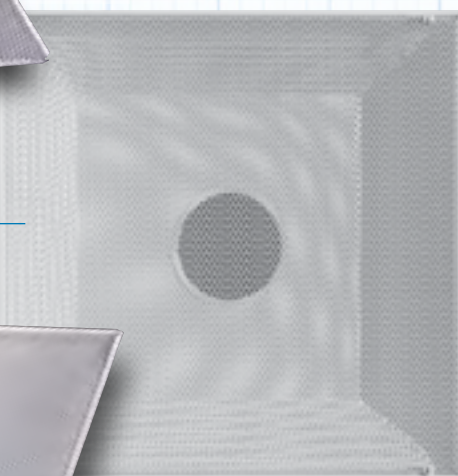

Model 1480RD

T-Bar Perforated Supply Diffuser

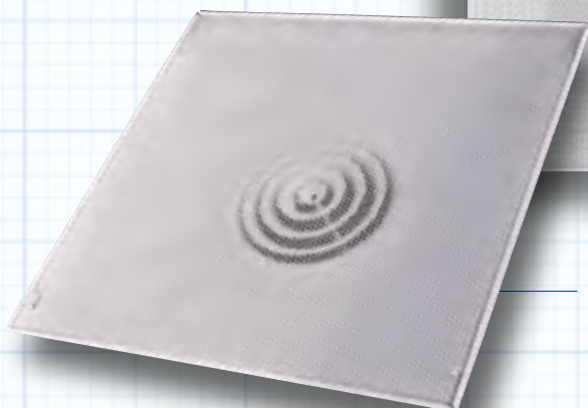

Compare to:	1400	1444	1480
Hart & Cooley	CBPS	CBPR	--
Titus	PCS	PDR	--
Shoemaker	825	830	--
Metal Aire	7600	--	--
Price	--	--	--
Krueger	--	--	--

Features

- Steel construction
- Seismic support tabs
- TRUaire Super Collar
- Hinged 51% free open area perforated face
- Fine line available on 1400CB and 1444RG Models
- Pristine white powder coat finish
- Optional molded R6 insulated back

Product Detail

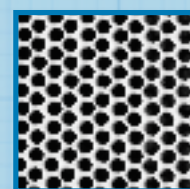

Steel Perforated Face 51% Open Area

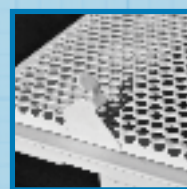

SmoothGlide™ Latch Technology

Lay-In Perforated Hinge Face Diffusers

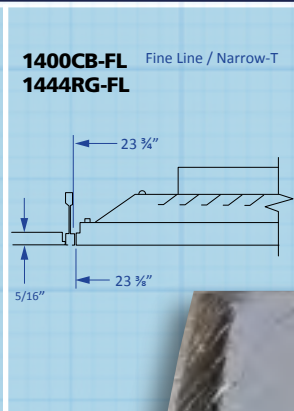
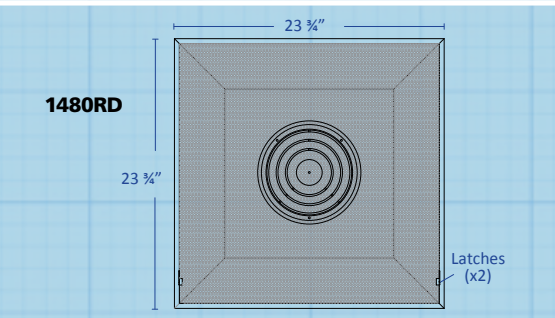
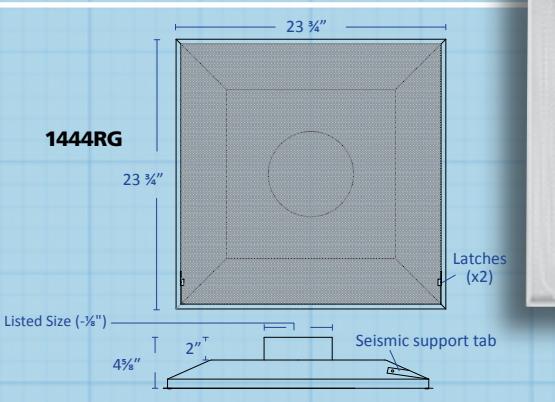
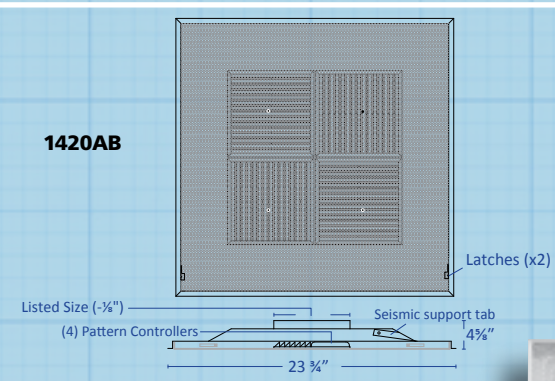
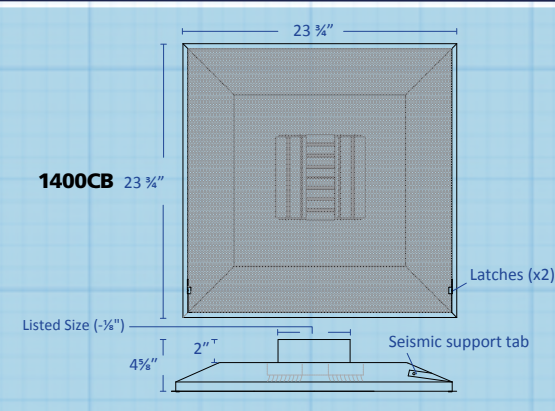

1400 Series Options

Optional Molded Insulated Back



Super Collar

2"

Model 1444RG
Perforated Return Grille

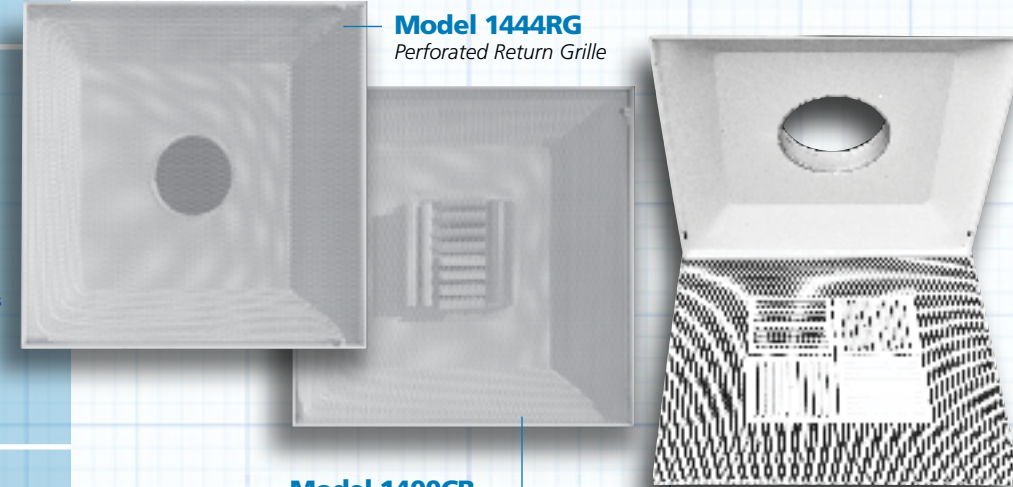

Model 1400CB
Curved Blade Supply Diffuser

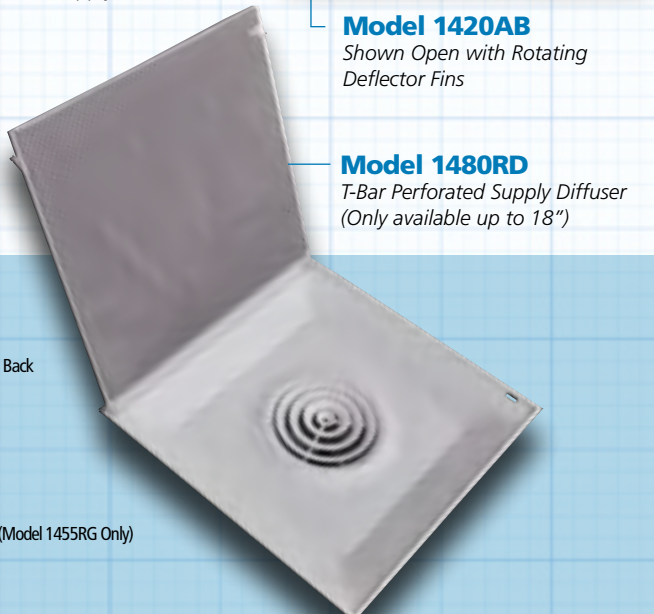

Model 1420AB
Shown Open with Rotating Deflector Fins

Model 1480RD
T-Bar Perforated Supply Diffuser (Only available up to 18")

Model Number Specifications

1400CB-FL/08IN

T-Bar Hinged Perforated Face Diffuser Style

- 00CB = Curved Blade Supply
- 20AB = Deflector Supply
- 44RG = Round Neck Return
- 55RG = Square Neck Return
- 80RD = Round Supply

Fine Line

- Blank = Lay-In
- FL = Fine Line

(Only Available on 1400CB and 1444RG)

R6 Insulation Option

- Blank = No Molded R6 Insulated Back
- IN = Molded R6 Insulated Back

Neck Size

- 06 = 6"Ø
- 08 = 8"Ø
- 10 = 10"Ø
- 12 = 12"Ø
- 14 = 14"Ø or 14 = 14" x 14" (Model 1455RG Only)
- 16 = 16"Ø
- 18 = 18"Ø
- 20 = 20"Ø

1110 Series

There are four basic face designs available in our T-Bar Return Panel product line with a couple of options for each model to address every installation concern. Every model is designed to be simple and flexible; ranging from the economy of stamped steel to the more luxurious and stylish look of aluminum egg crate.

Model 1110RG

Stamped Steel Panel

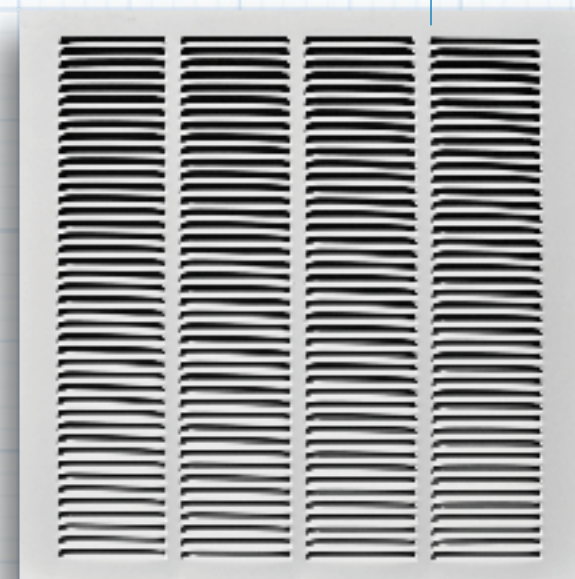

Model 1210RG

Model A1210RG

Fixed Bar Panel

60° Blade Angle from Face

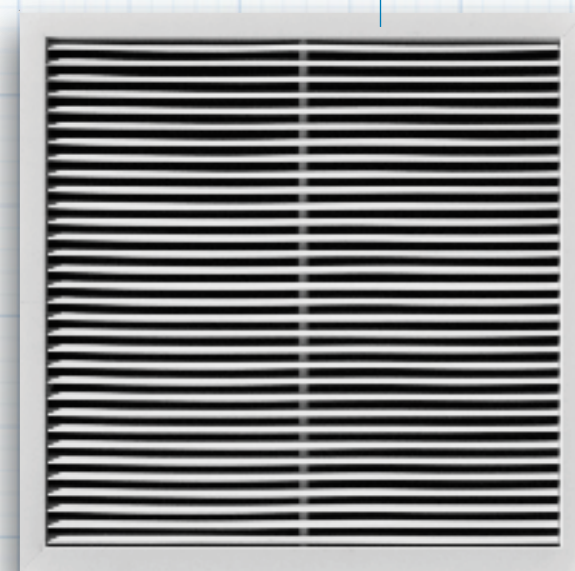

Features

- Versatile face designs
- T-Bar or Surface mount
- Rugged steel or aluminum models
- Durable white powder-coat

Product Detail



Stamped Steel with 1/2" Blade Spacing

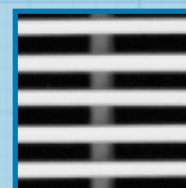

Steel Fixed Bar with 3/4" Blade Spacing

Model 1110RG - Stamped Steel Panel

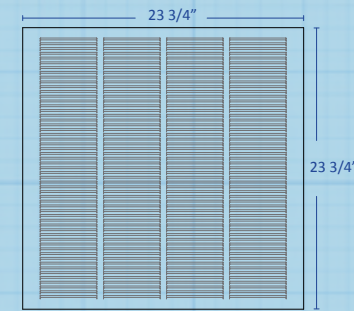

Model 1210RG / A1210RG - Fixed Bar Panel

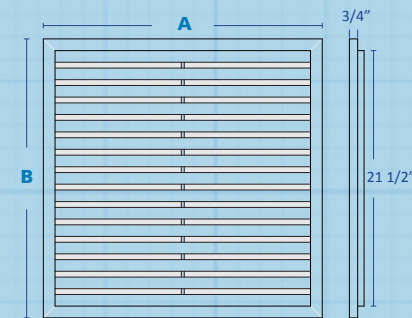

1110 SERIES DIMENSIONS

MODEL	A	B
-1	23 3/4"	11 3/4"
-2	23 3/4"	23 3/4"
-4	47 3/4"	23 3/4"



Model 1110RG - Detail View of Stamped Steel Panel with 1/2" Blade Spacing

Model Number Specifications

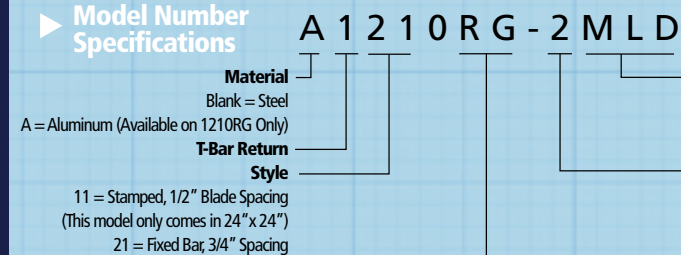

1110 Series Options

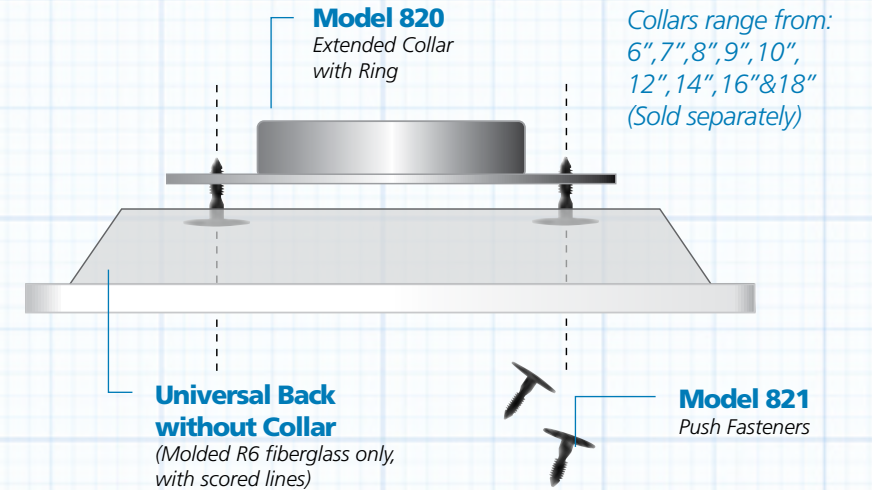

Model 1210RG
Model A1210RG

Fixed Bar Panel
60° Blade Angle from Face

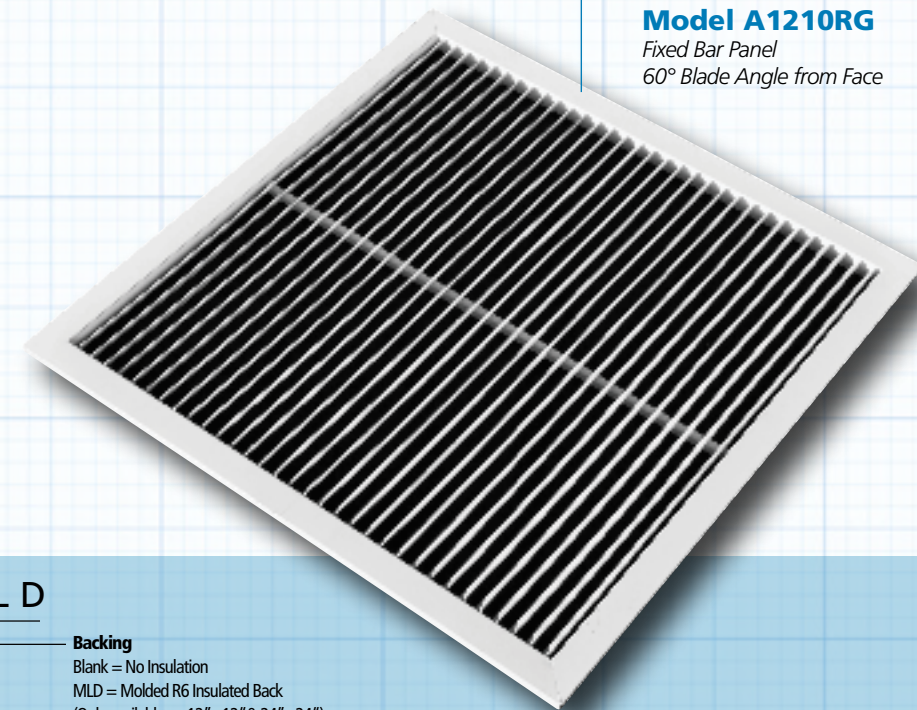

1900 Series

There are four basic face designs available in our T-Bar Return Panel product line with a couple of options for each model to address every installation concern. Every model is designed to be simple and flexible; ranging from the economy of stamped steel to the more luxurious and stylish look of aluminum egg crate.

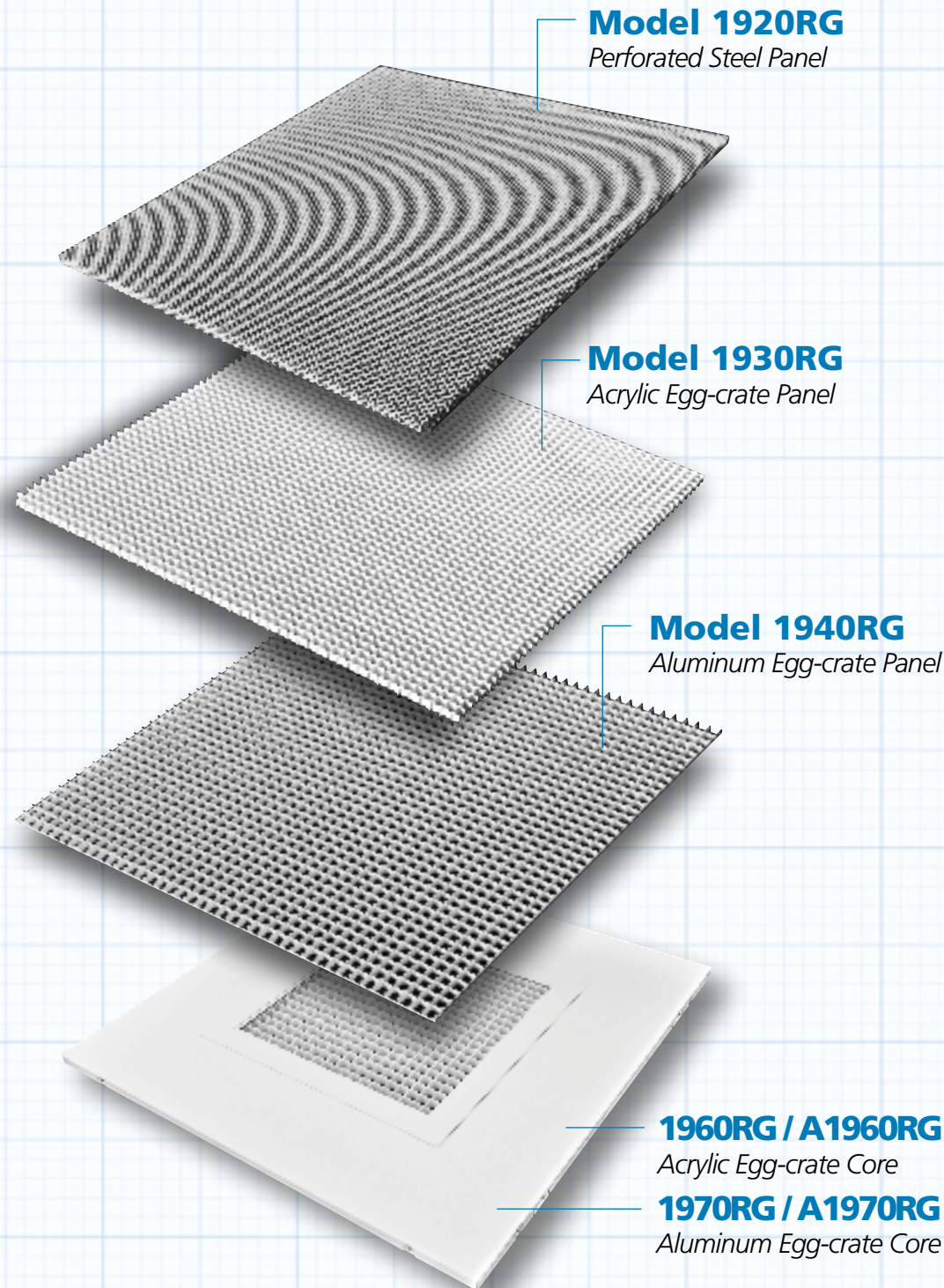

Model 1920RG
Perforated Steel Panel

Model 1930RG
Acrylic Egg-crate Panel

Model 1940RG
Aluminum Egg-crate Panel

1960RG / A1960RG
Acrylic Egg-crate Core

1970RG / A1970RG
Aluminum Egg-crate Core

Features

- Versatile face designs
- T-Bar or Surface mount
- Rugged steel or aluminum models
- Durable white powder-coat (except aluminum egg-crate)

Product Detail

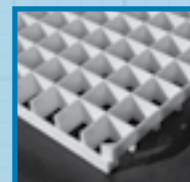

Acrylic Egg Crate Aluminum Egg Crate

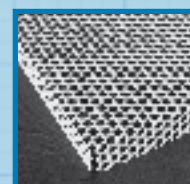

Perforated Face

Model 1920RG

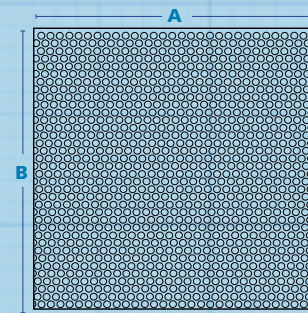

Model 1930RG / 1940RG

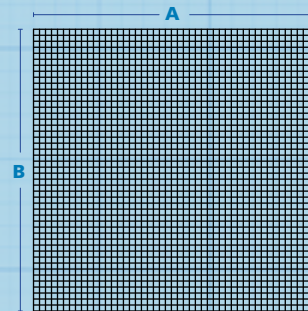

1900 SERIES DIMENSIONS

MODEL	A	B
-0	11 3/4"	11 3/4"
-1	11 3/4"	23 3/4"
-2	23 3/4"	23 3/4"
-4	23 3/4"	23 3/4"

Model 1960RG / 1970RG

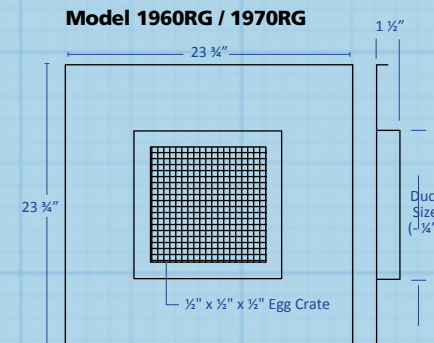

Model Number Specifications

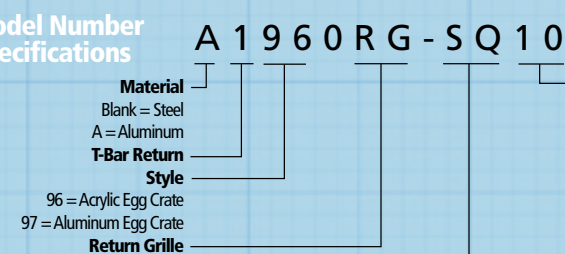

Model Number Specifications

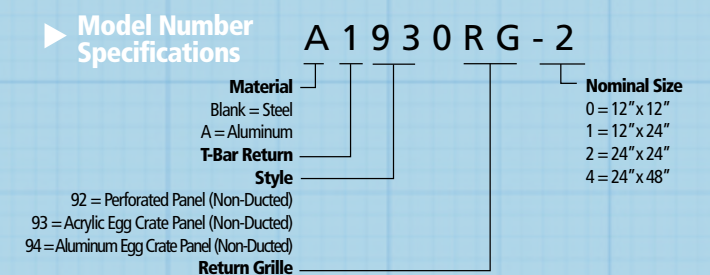

T-Bar Return Air Panel Options

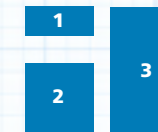

12" x 24"
Perforated
Face Shown

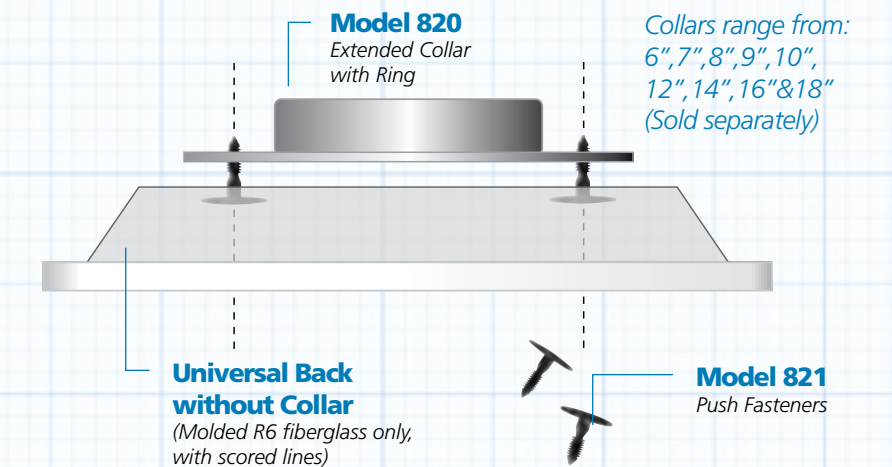
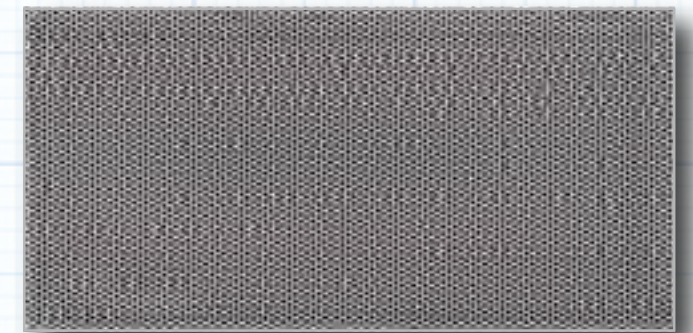

2000 Series

Step Down Diffusers go by many names; Lay-ins, Cone Diffusers, or even T-Bar Diffusers. The term "T-Bar" comes from the shape of the railing that holds the ceiling tiles in a drop ceiling. The railing forms a grid of squares and T-Bar Diffusers are designed to fit, or "lay-in", those grid squares.

The "cone" shape of the diffuser allows for a maximum volume of airflow into the air-conditioned space.



Model 2000PD
Model A2000PD
Single Plaque Diffuser



Model 2003CD
Model A2003CD
2 Cone Diffuser



Model 2004CD
Model A2004CD
3 Cone Diffuser



Compare to:

	2000PD	2003CD	2004CD
Hart & Cooley	DPD	FPD/FPD3	FPD/FPD3
Titus	OMNI	TMS	TMS
Shoemaker	HL	HVL/HVD	HVL/HVD
Metal Aire	5750	5800	5800
Price		SCD	SCD
Krueger	PLQ	1400	1400

Features

- Steel construction
- Aluminum construction on 2000PD, 2003CD and 2004CD
- Seismic support tabs
- TRUaire Super Collar
- Pristine white powder coat finish
- Optional molded R6 insulated back
- Optional butterfly damper
- Optional radial damper

Product Detail

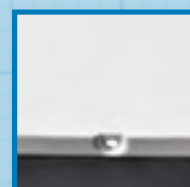

Recessed hanger wire hole

MODEL 2013CD

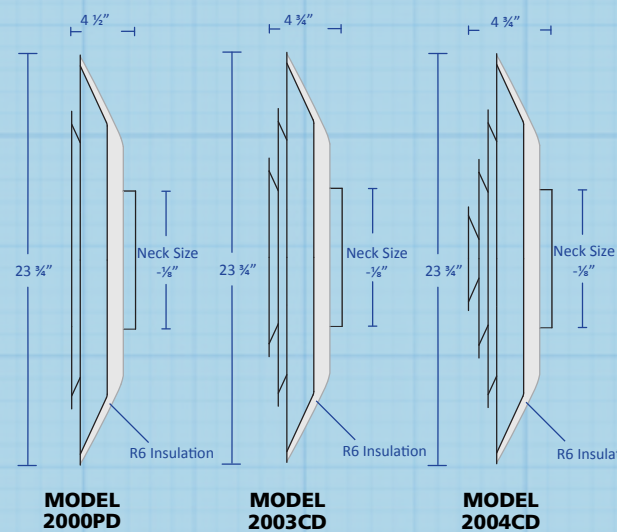
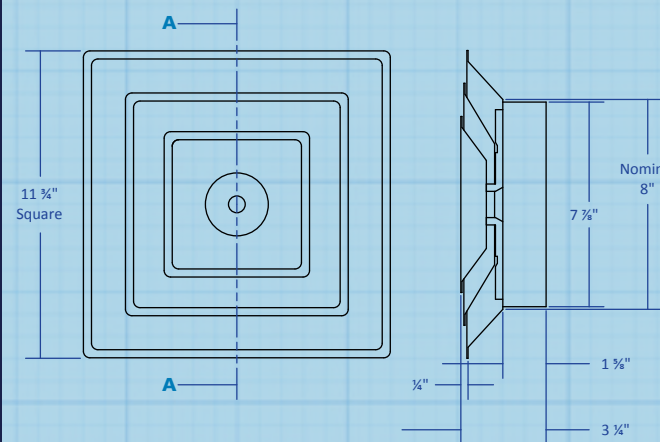

OPTIONAL DAMPERS

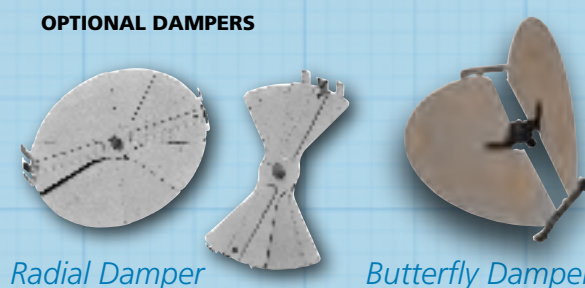

Radial Damper

Butterfly Damper

Model Number Specifications

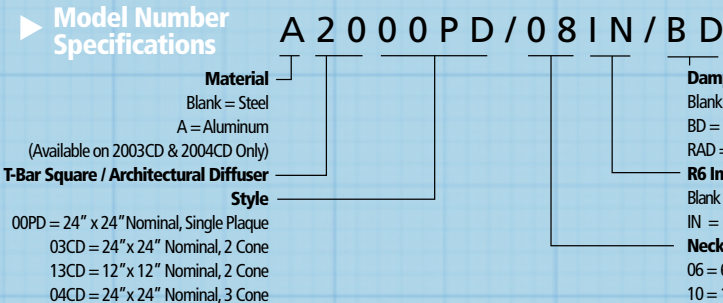

2000 Series Options

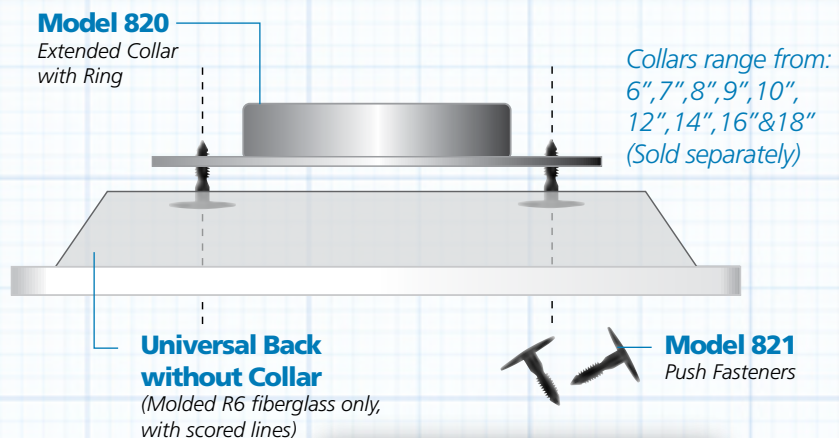

Steel Back with Collar
(uninsulated, fixed Super-Collar)



R6 Insulated Steel Back with Collar
(Steel back, R6 insulation, fixed Super-Collar)

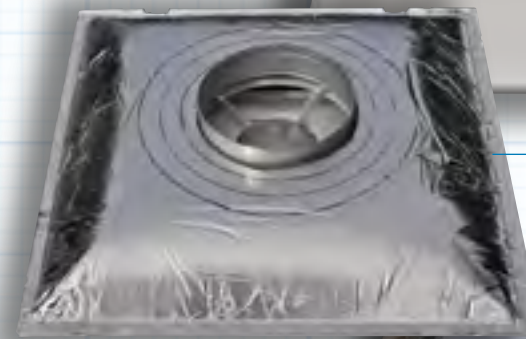

R6 Insulated Steel Back without Collar



Super Collar 2"



This exclusive Truair Super-collar is the Installer's dream come true. Made from extra-heavy gauge Electro-galvanized steel, this collar will not flex or buckle under the pressure of a zip-screw gun. It stands a full 2" tall, and comes with a solid steel "bead" around the entire collar to help prevent any flex duct slippage.

2600 Series

The 2600 Series diffusers are the perfect blend of style, function, and economy. As with everything TruAire makes, economy doesn't mean sacrificing quality. Manufactured with the highest standards, using heavy gauge steel and finished with our pristine white powder-coat, these stamped four-way diffusers utilize a large curved blade design providing a wide area of effective air diffusion. The outwardly curved blade pattern is an architecturally attractive design proving that form can also follow function.

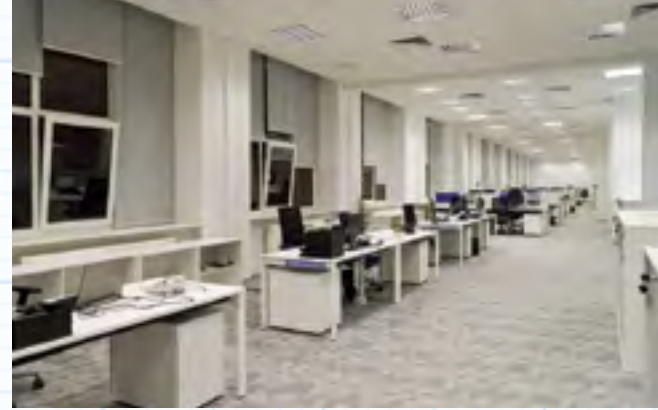

Model 2604SC

Curved Blade Diffuser - Steel Construction



Compare to: 2604SC

Hart & Cooley	--
Shoemaker	104
USAire	--
Continental	--
Lima	--
Airmate	--

Features

- Steel construction
- Seismic support tabs
- Stamped curved blade
- Pristine white powder coat finish
- Optional molded R6 insulated back
- Optional butterfly damper
- Optional radial damper
- Optional opposed blade damper

Product Detail



Optional Opposed Blade Damper

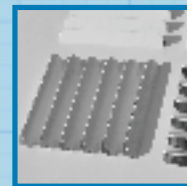

Detail view of stamped curved blades

2600 Series Options

Model 2604SC

No Damper

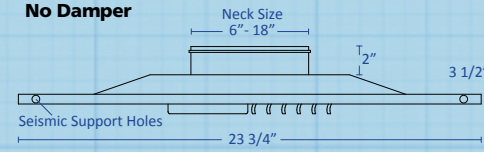

Opposed Blade Damper

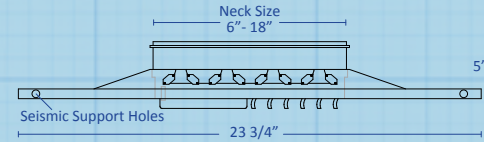

Insulated Back

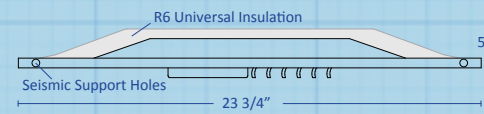

Model 2604SC-RD

With Round Neck

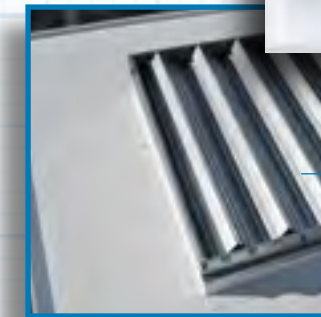

Opposed Blade Damper
With Traditional Square Neck

*Detail view - Model 2604SC
Reverse side shown with
Optional Opposed Blade Damper*

Model 802

Butterfly Damper

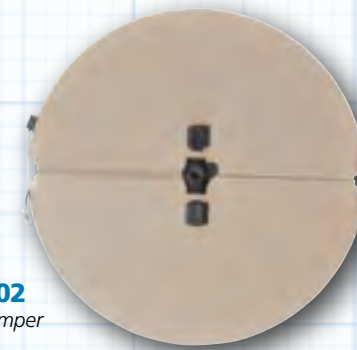

Model 804

Radial Damper

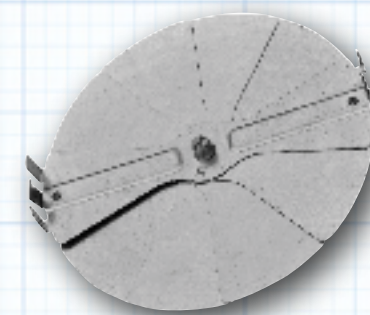

Model Number Specifications

2604SCOR10IN

T-Bar Stamped Curved Blade Diffuser

(4-Way Only)

Damper Option

Blank = No Damper

O = Opposed Blade

Neck Geometry

RD = Round

SQ = Square

R6 Insulation Option

Blank = No Molded R6 Insulated Back

IN = Molded R6 Insulated Back

Neck Size

06 = 6"Ø

08 = 8"Ø

10 = 10"Ø

12 = 12"Ø

14 = 14"Ø

16 = 16"Ø

18 = 18"Ø

4000 Series

The 4000 Series T-Bar Filter Grille line-up is a comprehensive combination of design, function, and budget. From the economy of stamped steel to the shine of aluminum egg-crate, and every design in between, we pour the same commitment to quality into every product.

Whether you're building your own plenum box or utilizing our pre-made plenum backs, we've got the right design and the right installation options to fit every project.

Model 4010FG

Stamped Face Return - 1/2" Fins

Model 4060FG

Stamped Face Return - 1/3" Fins



**Model 4020FG
Model A4020FG**

Fixed Bar Return Air Filter Grille

Model 4030FG

Perforated Face
Return Air Filter Grille

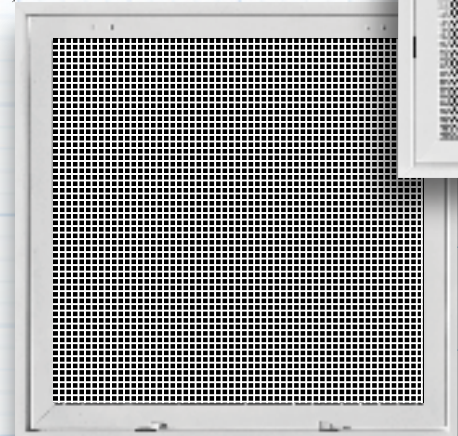

Model 4040FG (Acrylic)
Egg-Crate Return Air Filter Grille

Model 4050FG (Aluminum)
Egg-Crate Return Air Filter Grille



Compare to:	4020	4030	4050
Hart & Cooley	96AFBT	PFT/PFTI	REF5T
Titus			50FF-3
Shoemaker		105/106	600TFG
Metal Aire			CC5FB-TB
Price			80FF-TB
Krueger			EGCS

Features

- Steel construction
- Aluminum construction on A4020FG
- Fixed hinge face
- 5 face styles
- 1", 2" or 4" deep filter options
- 3 available sizes
- SmoothGlide Finger Latches
- Pristine white powder coat finish
- Optional molded R6 insulated back on filter Option 1
- Optional ductboard back on filter Option Ø and Option 4

NOTE: Filters are not included with return air filter grilles.

Product Detail

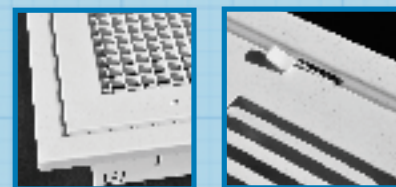

Premium Egg Crate SmoothGlide Latch

NOTE: All dimensions shown are typical for Model 4000 Series filter grilles.

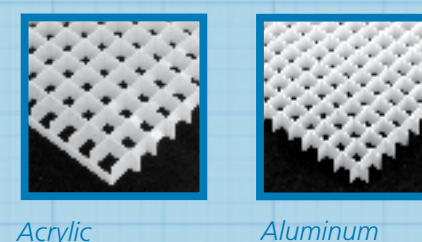
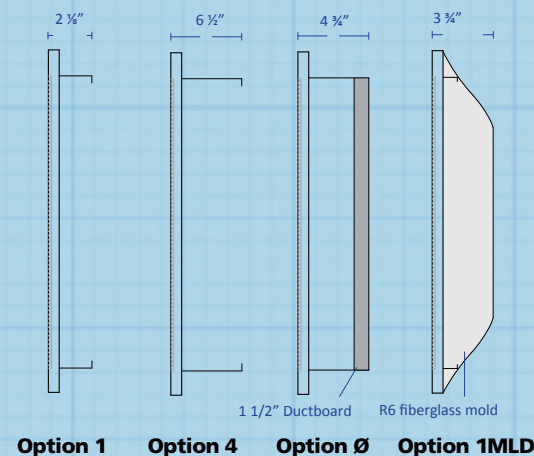
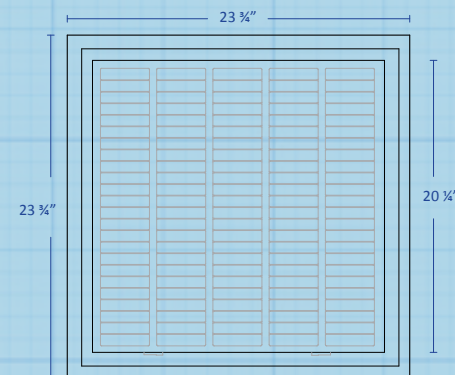

Acrylic Aluminum

4000 Series Options

Open Back - Without Duct Board

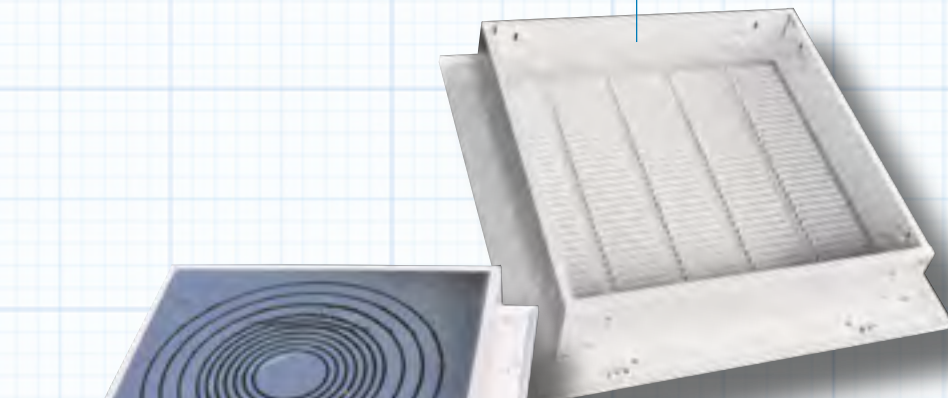

1 1/2" Ductboard Back



Universal R6 Molded Fiberglass Back

(*NOTE: The molded R6 back is available with 1" deep filter and 24"x 24" size)

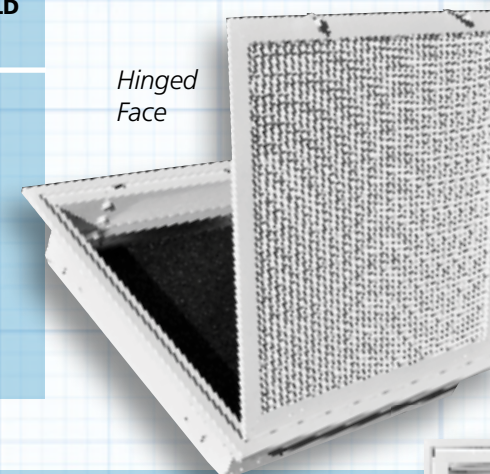

Hinged Face



Model 4020FG-4
Fixed Bar Return Air Filter Grille - 24" x 48"

Model Number Specifications

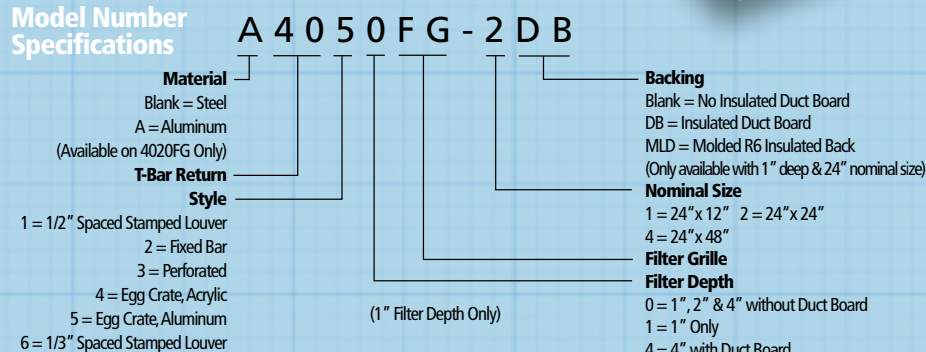

5200 Series

The 5200 Series Diffuser stands alone as the most versatile of all T-Bar Supply Diffusers. Four individually mounted aluminum snap-in **cores** can be arranged in one, two, three, or four-way throw configurations. The Model 5200 can also be arranged in a two-way corner throw for added versatility.

These four core sections are positioned together forming a square in the interior of either a top quality aluminum T-Bar panel, or less expensive steel T-Bar panel; both are 100% powder-coated to prevent rust and corrosion. Available with either steel or aluminum panels and in square or round duct connections or with the optional Opposed Blade Damper.

Model 5200CB

Aluminum Core - Steel Panel



Model A5200CB

Aluminum Core - Aluminum Panel

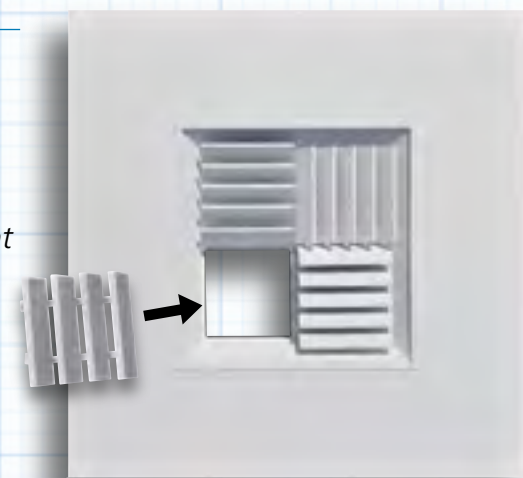

Shown with core component removed



Compare to:	5200	A5200
Hart & Cooley	MCDST	MCDST
Titus	MCD-3	MCD-3
Shoemaker	700MA	700MA
Metal Aire	9000	9000
Price	AMCD	AMCD
Krueger	1200	1200

Features

- Extruded aluminum core
- Available with either steel or aluminum panel
- Field configurable throw patterns; one, two, three or four way
- Pristine white powder coat finish
- Optional molded R6 insulated back
- Optional opposed blade damper

Product Detail

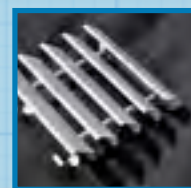

Detachable Cores



Recessed hanger wire hole

NOTE: All dimensions shown are typical for both Model 5200CB and A5200CB.

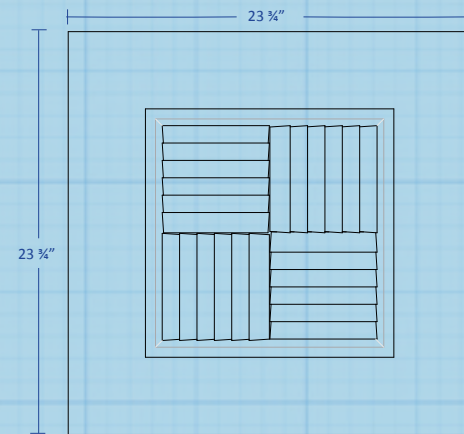

SQUARE NECK

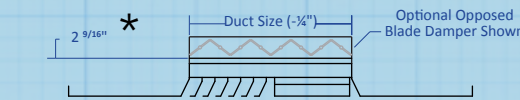

ROUND NECK

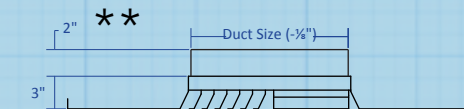

NOTES:

- *Optional opposed blade damper will increase height to 4 1/16"
- **Optional opposed blade damper will increase height to 5"

Field Configurable Throw Patterns

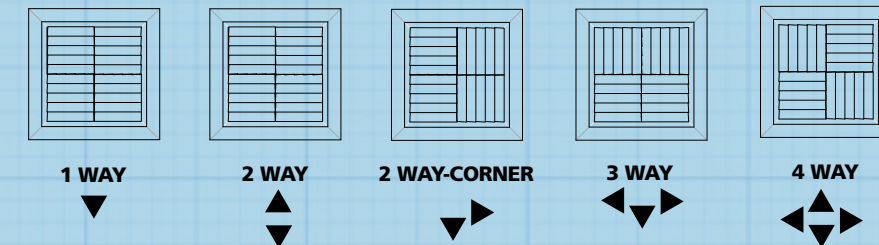

Detachable core panels can be arranged in a variety of airflow patterns

Model Number Specifications

A 5 2 0 0 C B O - R D 0 8 - I N

Material	A = Aluminum Panel / Aluminum Core	R6 Insulation Option	Blank = No Molded R6 Insulated Back
T-Bar Modular Core Diffuser		Neck Size	IN = Molded R6 Insulated Back
Damper Option	Blank = No Damper		06 = 6"Ø
	O = Opposed Blade		08 = 8"Ø
Neck Geometry			10 = 10"Ø
	RD = Round		12 = 12"Ø
	SQ = Square		14 = 14"Ø
			16 = 16"Ø
			18 = 18"Ø
			20 = 20"Ø

5200 Series Options



Round Collar (RD)

Traditional Square Neck (SQ)

Opposed Blade Damper with Round Collar

Opposed Blade Damper with Traditional Square Neck

5400 Series

This attractive T-Bar design comes in a sleek low-profile blade arrangement, engineered to be "flush" with the ceiling. This diffuser might be considered the architects first choice for small to medium-sized commercial projects.

The all aluminum blade construction, in one, two, three, four-way, and even two-way corner throw configurations, can be ordered in a matching aluminum T-Bar panel, or a rugged steel T-Bar panel. The back of this diffuser comes in 6, 9, 12, 15, and 18-inch square neck configurations or with a Universal Fiberglass Back. Optional high-quality Opposed Blade Dampers and optional insulation rounds out the offering.



Compare to:	5400	A5400
Hart & Cooley	SRT/ART	SRT/ART
Titus	TDC	TDC
Shoemaker	700	700
Metal Aire	5500	5500
Price	SMD	SMD
Krueger	SH23	SH23

Model 5400SD Aluminum Core / Steel Panel
Model A5400SD Aluminum Core / Aluminum Panel
 4-Way Deflection (Shown with blades removed)

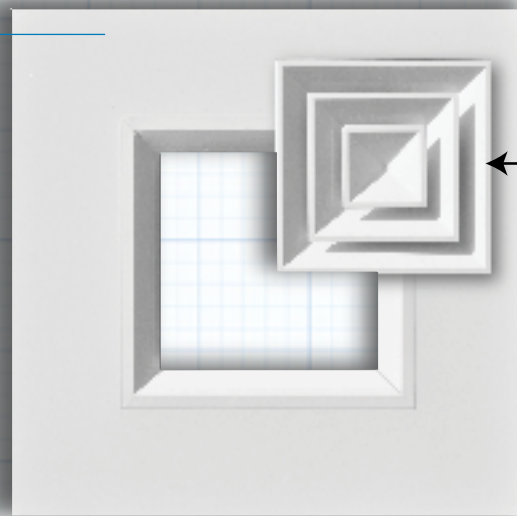

Easy-to-change modular blades are interchangeable. Choose from air-throw patterns below. **NOTE:** Model 5404SD is most common.

Features

- Extruded aluminum core
- Available with steel or aluminum panel
- 5 air-throw patterns
- Removable center core
- Pristine white powder coat finish
- Optional molded R6 insulated back
- Optional opposed blade damper

Product Detail



Recessed hanger wire hole



Low-Profile Blade Design

Lay-In Directional Diffuser

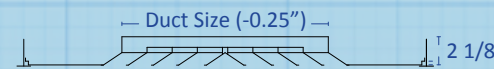
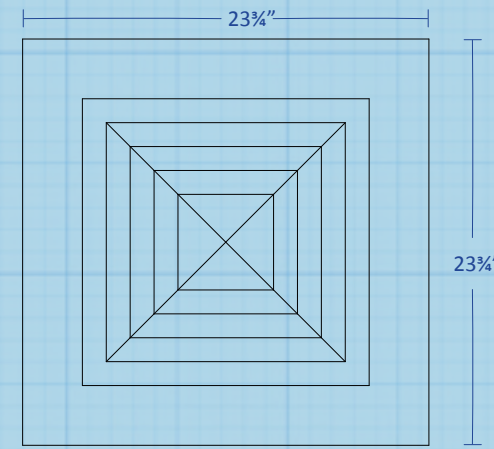

Accessory Part - 5400SD-06PAN
 (Available accessory frame steel panel ONLY)

5400 Series Options

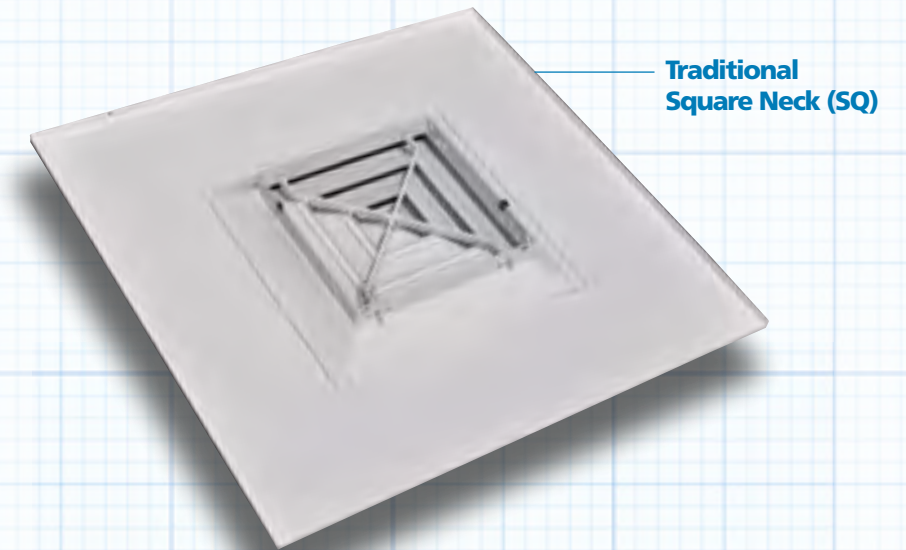

OBD with Traditional Square Neck

R6 Insulated Steel Back without Collar

Throw Patterns:

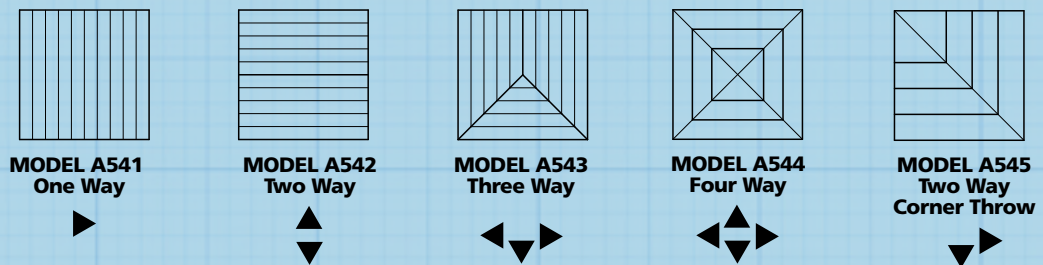

Model Number Specifications

A 5 4 0 4 S D O - R D 0 8 - I N

Material	A = Aluminum Panel / Aluminum Core	R6 Insulation Option	Blank = No Molded R6 Insulated Back
T-Bar Directional Diffuser		Neck Size	IN = Molded R6 Insulated Back
Throw Directions	1 = 1 Way 2 = 2 Way Parallel 3 = 3 Way 4 = 4 Way 5 = 2 Way Corner	06 = 6"Ø 08 = 8"Ø 10 = 10"Ø 12 = 12"Ø 14 = 14"Ø 16 = 16"Ø 18 = 18"Ø 20 = 20"Ø	Neck Geometry
Square Diffuser		RD = Round SQ = Square	
Damper Option	Blank = No Damper O = Opposed Blade Damper		



SU Series

TRUaire's SU series universal spiral duct supply grilles are designed to be installed directly on round or spiral duct, eliminating the need for costly register taps and offer a clean, low profile appearance. These grilles come in either vertical single deflection or front vertical double deflection. They have 3/4" spacing and individually adjustable blades and a high density closed cell foam gasket on each end which allow the grille to form seamlessly to multiple duct diameters. Optional air scoop extracts air from the duct, allowing for air balancing and uniform air flow.



Model SU1A
Single Deflection
Aluminum Finish

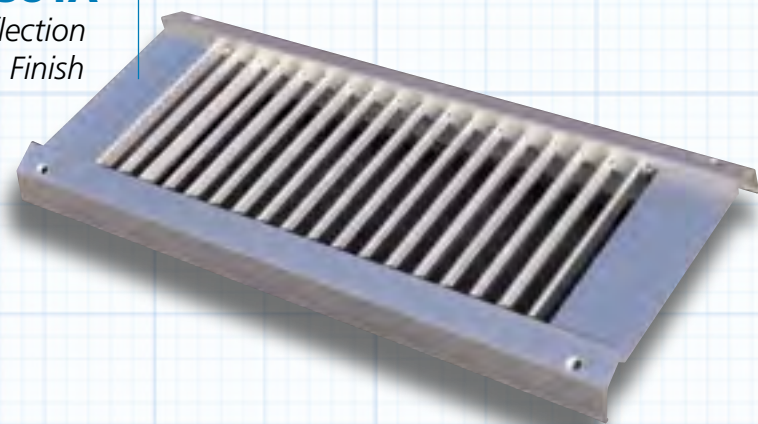

Model SU2W
Double Deflection
Pristine White Finish

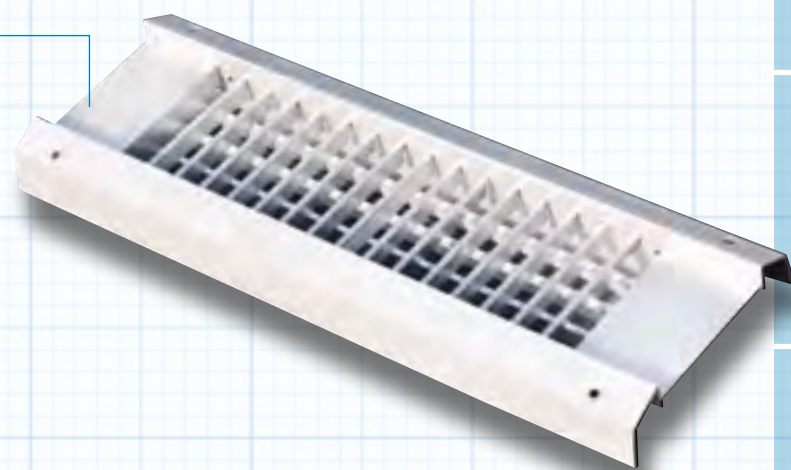

Compare to:

	SU1	SU2
Hart & Cooley	USV	USV1+
Titus	US301F	US300F
Shoemaker	USR52	USR34
Metal Aire	--	--
Price	--	--
Krueger	DMGSU	DMGDU

Features

- Aluminum construction
- SU1 is single deflection with individually adjustable vertical blades
- SU2 is double deflection with individually adjustable blades with vertical front blades
- 3/4" blade spacing
- Open cell foam gasket for air tight seal
- Pristine white or aluminum powder coat finishes
- Optional scoop damper

Available Finishes



Product Detail

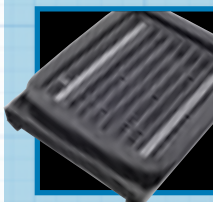

Reverse side of Universal Model showing thick foam

SU Model Dampers

Optional Scoop Damper

An optional air scoop is available to divert a portion of the airstream out through the register



Detail View of Scoop Option

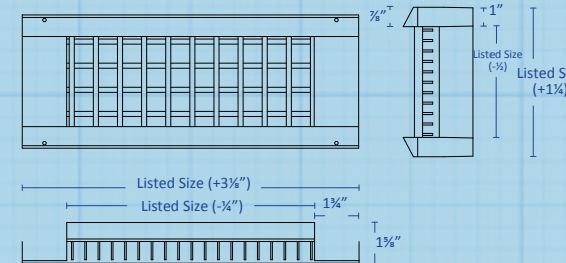

Model SU Minimum / Maximum Duct Diameters

Duct Diameter (IN)	GRILLE HEIGHT (IN)					
	3	4	6	8	10	12
Min/Max	6/36	8/36	10/36	12/36	14/36	26/36



Detail View of reverse side of Model SU2A

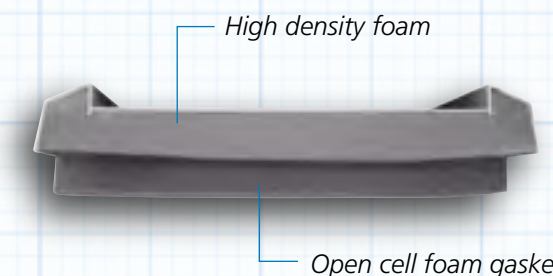

Profile View showing high density foam perimeter

Model Number Specifications

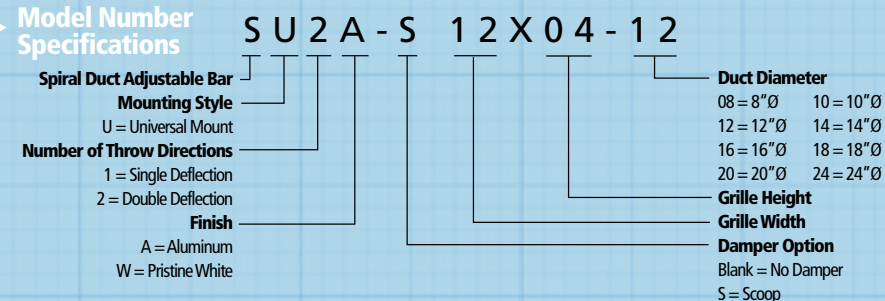

SD Series

TRUaire's SD series spiral duct supply grilles are designed to be installed directly on round or spiral duct, eliminating the need for costly register taps and offers a clean appearance. The curved saddle of these grilles is designed to follow the contour of round or spiral duct for a tight fit. These grilles come in either a vertical single deflection or front vertical double deflection. Optional air scoop or optional aluminum opposed blade damper both have a screwdriver adjustment which is accessible through the face of the registers allowing for air balancing and uniform air flow.



Model SD1A-O

Saddle Type
Single Deflection
White Finish

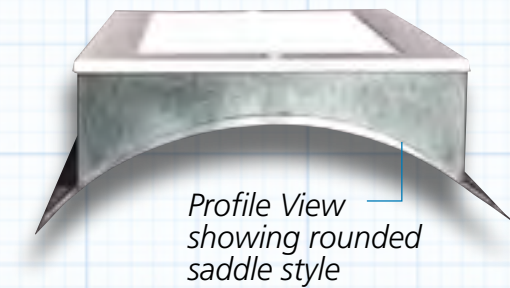
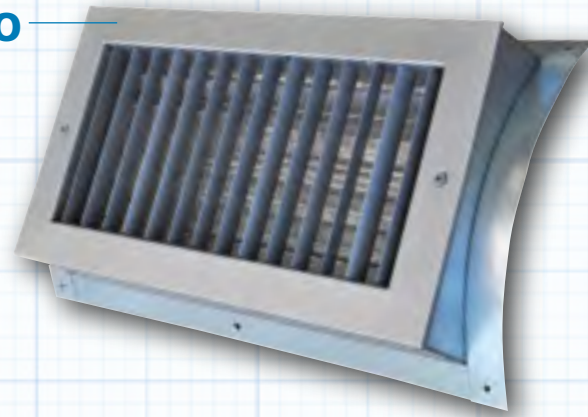

Model SD2W

Saddle Type
Double Deflection
Aluminum Finish



Compare to:

SD	SD
Hart & Cooley	USV
Titus	US
Shoemaker	
Metal Aire	
Price	SDG
Krueger	DMG

Features

- Aluminum construction
- Galvanized saddle construction
- 3/4" blade spacing
- SD1 is single deflection with individually adjustable vertical blades
- SD2 is double deflection with individually adjustable blades with vertical front blades
- Pristine white or aluminum powder coat finishes
- Optional scoop damper
- Optional opposed blade damper

Available Finishes



Product Detail



Optional Opposed Blade Damper

SD1/ SD2 Model Dampers

Optional Scoop Damper

An optional air scoop is available to divert a portion of the airstream out through the register

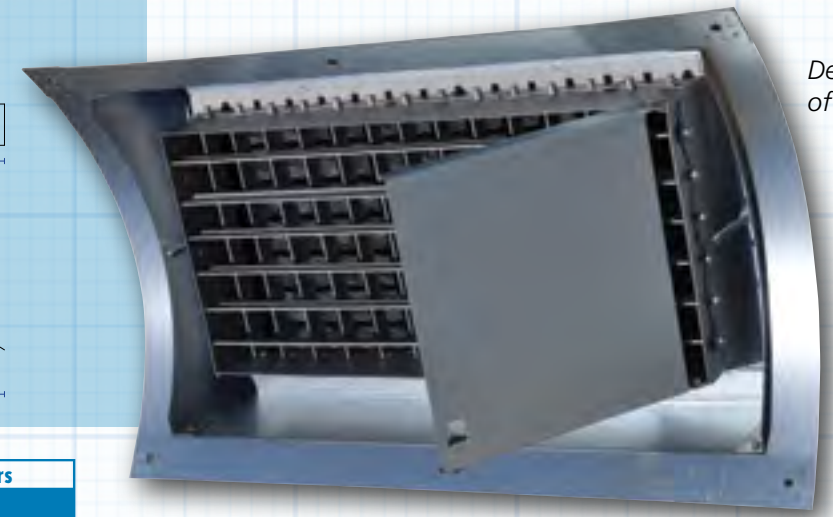
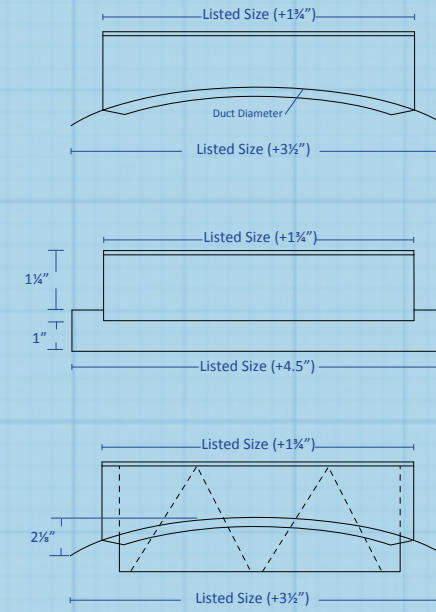

Detail View of Scoop Option

Model SD Minimum / Maximum Duct Diameters

Duct Diameter (IN)	GRILLE HEIGHT (IN)					
	3	4	6	8	10	12
Min/Max	10/36	10/36	12/36	20/36	24/36	24/36

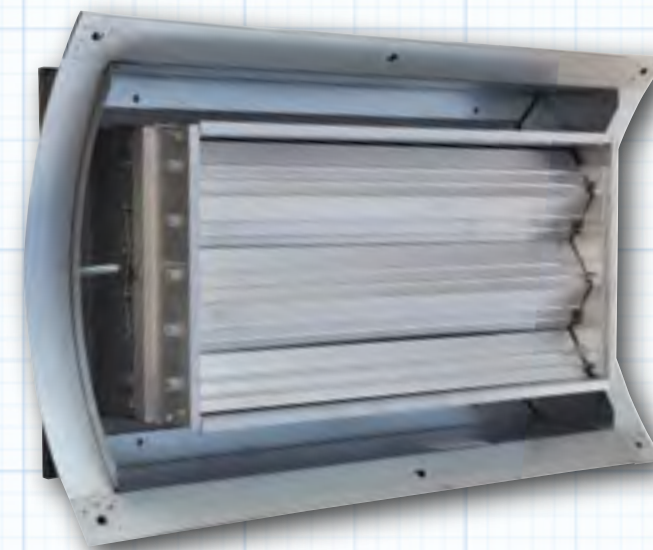

Detail View of Opposed Blade Damper Option

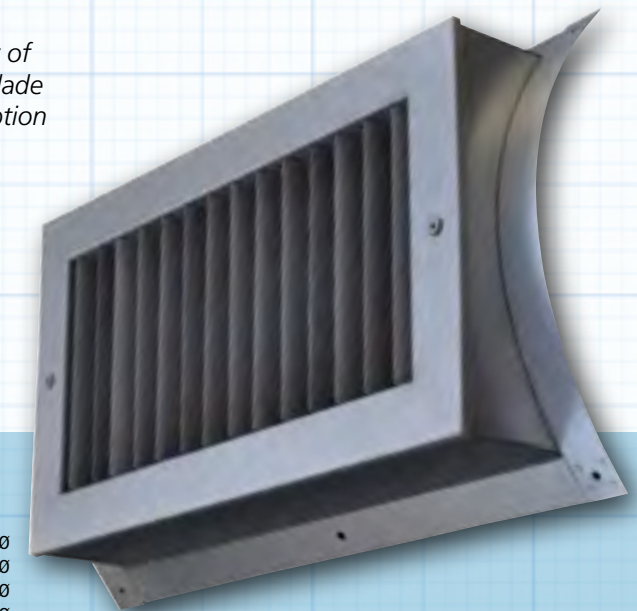

Detail View of blade spacing, saddle mount style and frame with aluminum finish.

Model Number Specifications

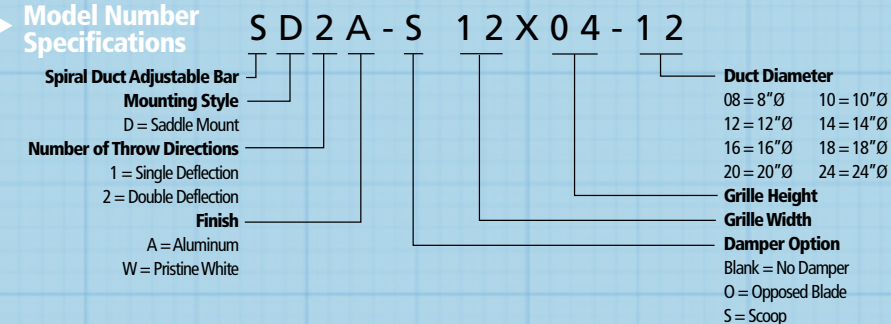

SF Series

Truairé's SF series spiral duct supply grilles are designed to be installed directly on round or spiral duct, eliminating the need for costly register taps and offers a clean, low profile appearance. The curved frame of these grilles is designed to follow the contour of round or spiral duct and has a closed cell gasket for an air tight fit. These grilles come in either vertical single deflection or front vertical double deflection. Optional air scoop or optional aluminum opposed blade damper both have a screwdriver adjustment which is accessible through the face of the registers allowing for air balancing and uniform air flow.



Model SF1A

Saddle Type
Single Deflection
Aluminum Finish



Model SF2W-S

Saddle Type
Double Deflection
Aluminum Finish
with Scoop

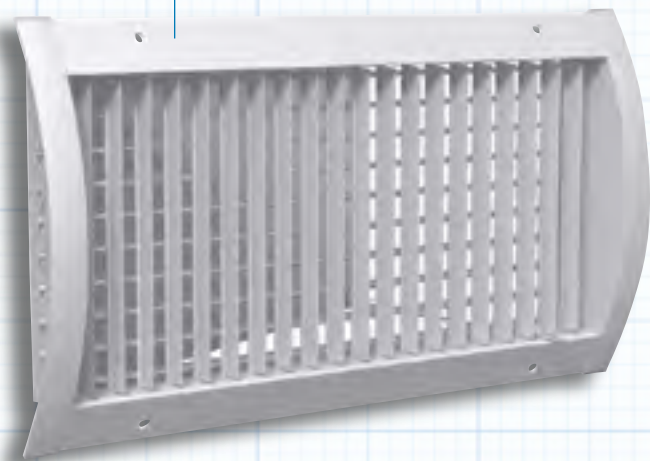

Compare to:	SF1	SF2
Hart & Cooley	SV	SVH
Titus	S301F	S300F
Shoemaker	SD52	SD34
Metal Aire	4002PCF	4004PCF
Price	--	SDGE
Krueger	DMGSR	DMGDR

Features

- Aluminum construction
- SF1 is single deflection with individually adjustable vertical blades
- SF2 is double deflection with individually adjustable blades with vertical front blades
- Foam gasket for air tight seal
- 3/4" blade spacing
- Pristine white or aluminum powder coat finishes
- Optional scoop damper
- Optional opposed blade damper

Available Finishes

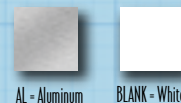

Product Detail



Optional Opposed Blade Damper

SF1/ SF2 Model Options

Optional Scoop Damper

An optional air scoop is available to divert a portion of the airstream out through the register.

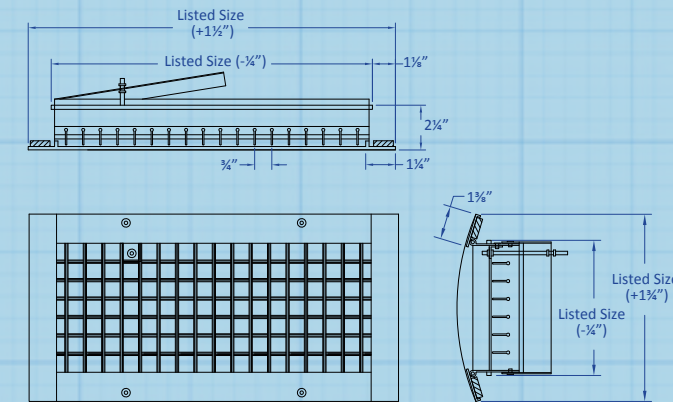

Duct Diameter (IN)	GRILLE HEIGHT (IN)					
	3	4	6	8	10	12
Min/Max	6/36	8/36	10/36	12/36	14/36	16/36

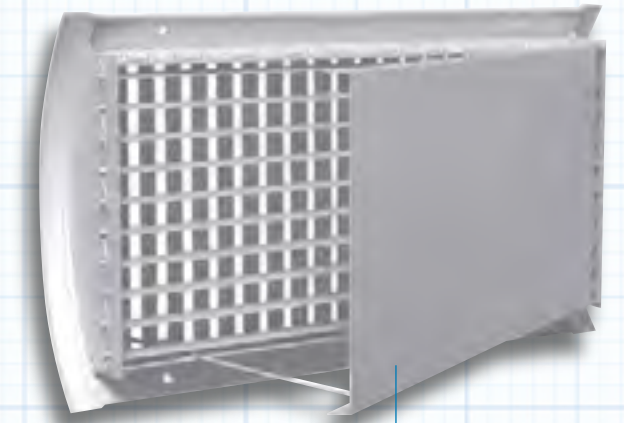

Detail View of Scoop Option in Pristine Powder Coat White Finish

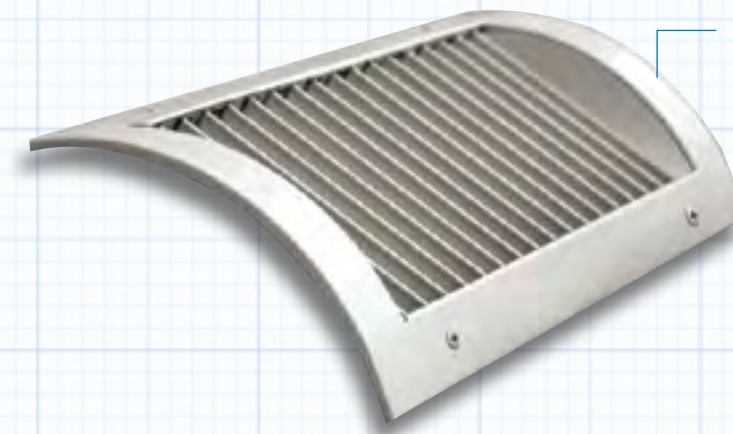

Profile View of Single Deflection in Aluminum Finish

Model Number Specifications

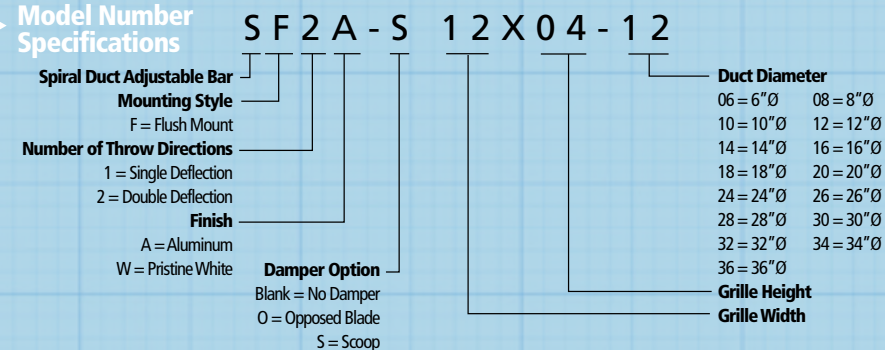

LD / LDR Series

Sleek and unobtrusive; linear slot diffusers are the architects dream come true. Long narrow slots take the place of traditional "blades". The installation is flush with the wall or ceiling, and the diffuser all but disappears within the natural lines of the structure.

Linear Slot Diffusers come in an almost endless variety of sizes, styles, lengths, widths and configurations. However, by far the most common, most used model is the simplest; standard 3/4" 2-slot diffuser in 2', 4', and 6' lengths. In stock, and on the shelf.



Model LD1
1 Slot Linear Diffuser

Model LD2
2 Slot Linear Diffuser

Model LD3
3 Slot Linear Diffuser

Model LD4
4 Slot Linear Diffuser

Compare to:	LD Series
Hart & Cooley	S75-1-2
Titus	ML
Price	SDS
Shoemaker	LSD
Metalaire	6600

Features

- Extruded aluminum construction
- 1/2", 3/4" and 1" slot widths
- 1 to 8 slots available
- Supply or return; Returns have omitted pattern deflectors
- 6 foot maximum one-piece construction
- Available in two end styles
- Custom Lengths available in both the LD and LDR models
- Pristine white powder coat finish

Product Detail



Reverse side of Linear Diffuser showing slots Detail of Extension Coupler

Features

- Extruded aluminum construction
- 0° or 15° deflection
- 6 foot maximum one-piece construction
- Custom lengths available
- Pristine white powder coat finish

Model LB
Linear Bar Diffuser - 1/4" Bar, 1/2" Spacing

MODEL LD

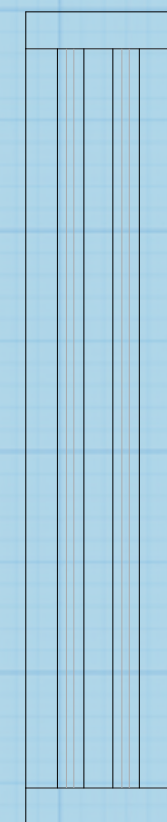

Model LD / LDR Series Dimensions (IN)																
Slot Size	1 SLOT		2 SLOT		3 SLOT		4 SLOT		5 SLOT		6 SLOT		7 SLOT		8 SLOT	
A	B	C	B	C	B	C	B	C	B	C	B	C	B	C	B	C
1/2"	2 3/4"	1 5/8"	4"	2 7/8"	5 1/4"	4 1/8"	6 1/2"	5 3/8"	7 3/4"	6 5/8"	9"	7 7/8"	10 1/4"	9 1/8"	11 1/2"	10 3/8"
3/4"	3"	1 7/8"	4 1/2"	3 3/8"	6"	4 7/8"	7 1/2"	6 3/8"	9"	7 7/8"	10 1/2"	9 3/8"	12"	10 7/8"	13 1/2"	12 3/8"
1"	3 1/4"	2 1/8"	5"	3 7/8"	6 3/4"	5 5/8"	8 1/2"	7 3/8"	10 1/4"	9 1/8"	12"	10 7/8"	13 3/4"	12 5/8"	15 1/2"	14 3/8"

Choose number of slots and slot size, then determine corresponding measurements using chart below:

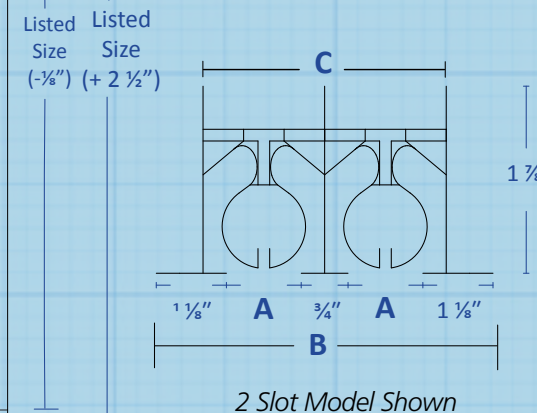

Greater Design Flexibility

TRUaire's linear slot diffusers offer high performance with a 180° range of air pattern adjustment and complete flow rate control. Each model features a solid extruded aluminum border and frame construction which is sure to compliment any modern architectural design giving you true flexibility in application.

Optional flat end plate

Model LD
3-Slot Linear Diffuser
Reverse Side Shown with Adjustable Pattern Deflectors and Flat End Plate.

Channel style mounting bracket included

Model LB
Linear Bar Diffuser
Reverse Side Shown with 1/4" Bar and 1/2" Spacing.

MODEL LB

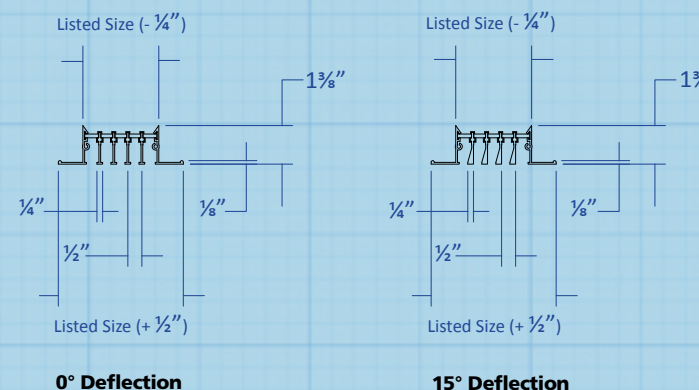

Model Number Specifications

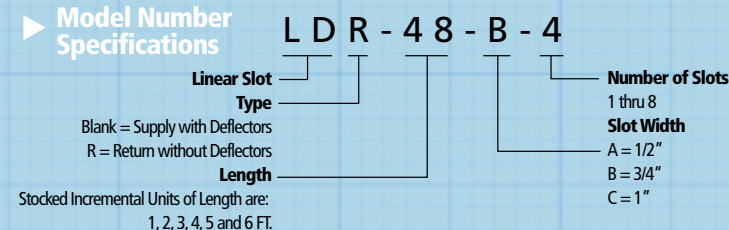

Model Number Specifications

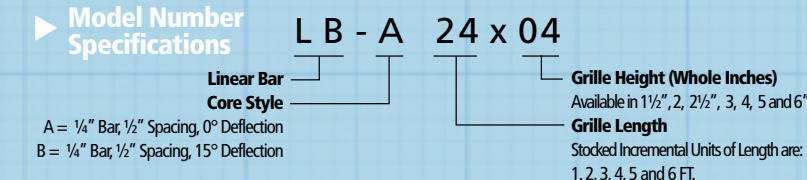

PTA Series

TRUAire's PTA series premium line of PTAC grilles will enhance the outside aesthetics of any hotel, extended-stay properties, suites, assisted living, student housing or any other facility that uses Packaged Terminal Air Conditioners and Heat Pumps. The PTAC grilles come in two styles, the standard, cost effective, one piece stamped durable aluminum grille or the extruded aluminum architectural fixed bar grille. Both styles of rear grilles provide protecting for the outdoor components from the damaging effects of harsh weather.



PTA170

PTAC Grille - Aluminum Stamped Louver

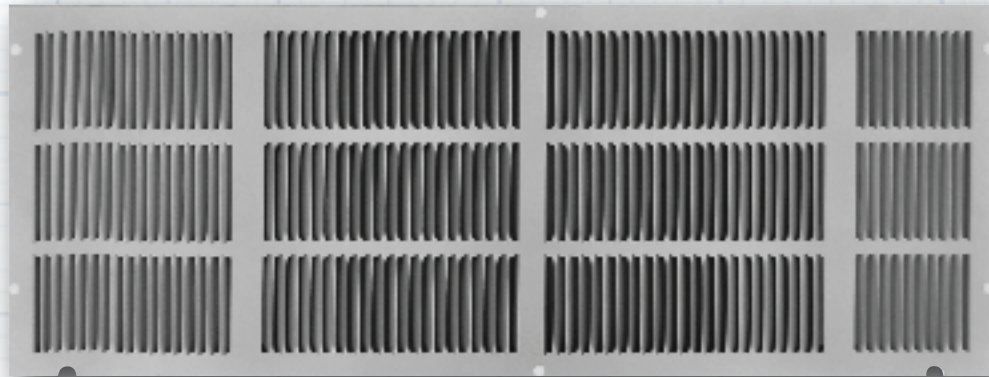

PTA170 Features

- Stamped aluminum construction
- 1/2" louver spacing
- 50° louver pitch
- 3 powder coat finishes; brown, white or aluminum

PTA270 Features

- Extruded aluminum construction
- 3/4" blade spacing
- 50° blade pitch
- 3 powder coat finishes; brown, white or aluminum

PTA270 / PTA271 / PTA272

PTAC Grille - Extruded Aluminum Fixed Bar



Available Finishes



Product Detail



Detail View of Stamped Blades on Model PTA170

Detail View of Louvered Blades on Model PTA270

Model PTA170 - Aluminum Stamped Louver

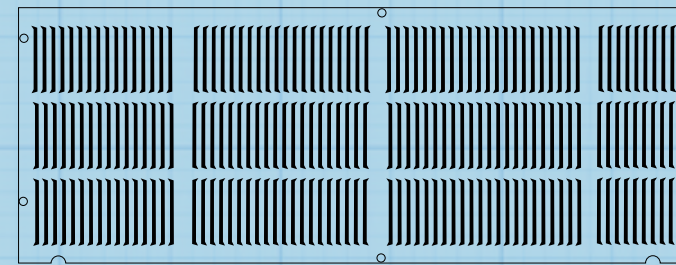

Model PTA270 - Aluminum Fixed Bar Type

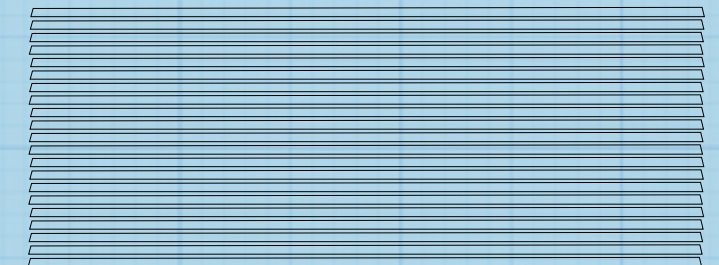

Model PTA270 detail view of reverse side showing blade spacing, fixed bar style and aluminum finish.

Detail View of Reverse Side on Model PTA170

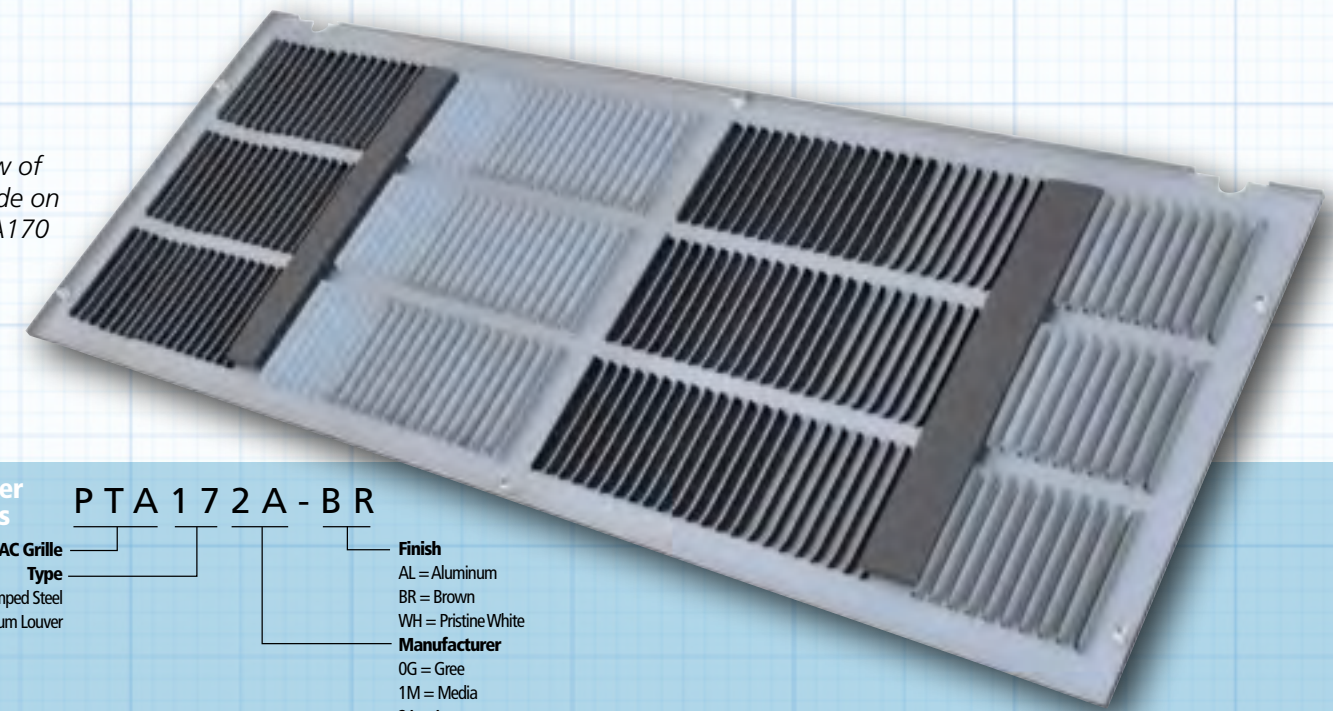

Model Number Specifications

PTA 172 A - B R

- PTAC Grille Type**
17 = Stamped Steel
27 = Aluminum Louver
- Finish**
AL = Aluminum
BR = Brown
WH = Pristine White
- Manufacturer**
OG = Gree
1M = Media
2A = Amana

ACD690 / 670 Series

Truairé's ACD690 Series access doors and 670 Series access panels are an economical and attractive access door for walls and/or ceilings. Both models are ideally suited for apartment, condominiums and office buildings where easy access to mechanical, electrical and plumbing fixtures behind a walls and/or ceilings is required.

They are designed for installations in drywall, plaster, masonry, tile or any flush surface. These access doors have concealed fixed hinges and Smooth-Glide Technology finger latches. ACD690 access doors have a 1-3/8" exposed flange that completely conceals the wall and/or ceiling opening while the 670 Series access panels are oversized by 1-3/8" to completely conceal the listed wall and/or ceiling opening providing a clean finish look.



Model ACD690
Solid Face Access Door
Hinged Face



Model 670
Solid Face Access Panel
Screw Mount

Compare to:

	ACD690
Hart & Cooley	HCAD
Shoemaker	AD
USAire	LAD
Continental	AD
Lima	--
Airmate	--

Features

- Steel construction
- Fixed hinge panel on ACD690 only
- SmoothGlide finger latches on ACD690 only
- Pristine white powder coat finish

Product Detail

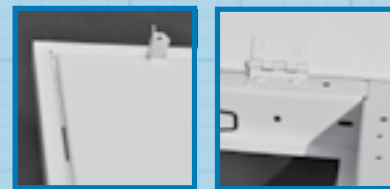

Access Panel Latch Access Panel Fixed Hinge

Model ACD690 - Solid Face Access Door

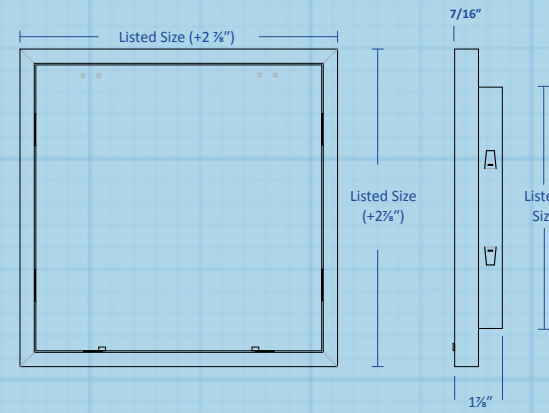

Model ACD670 - Solid Face Access Panel

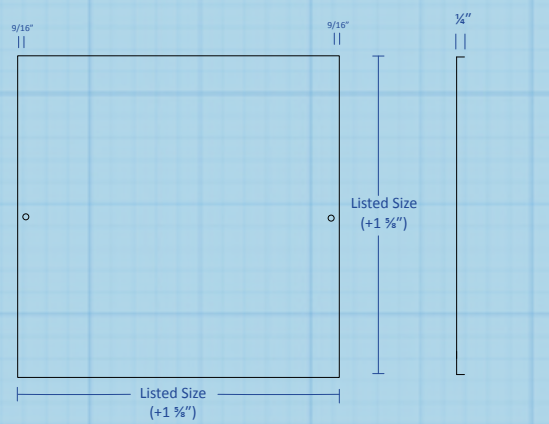

ACD690 Series Features

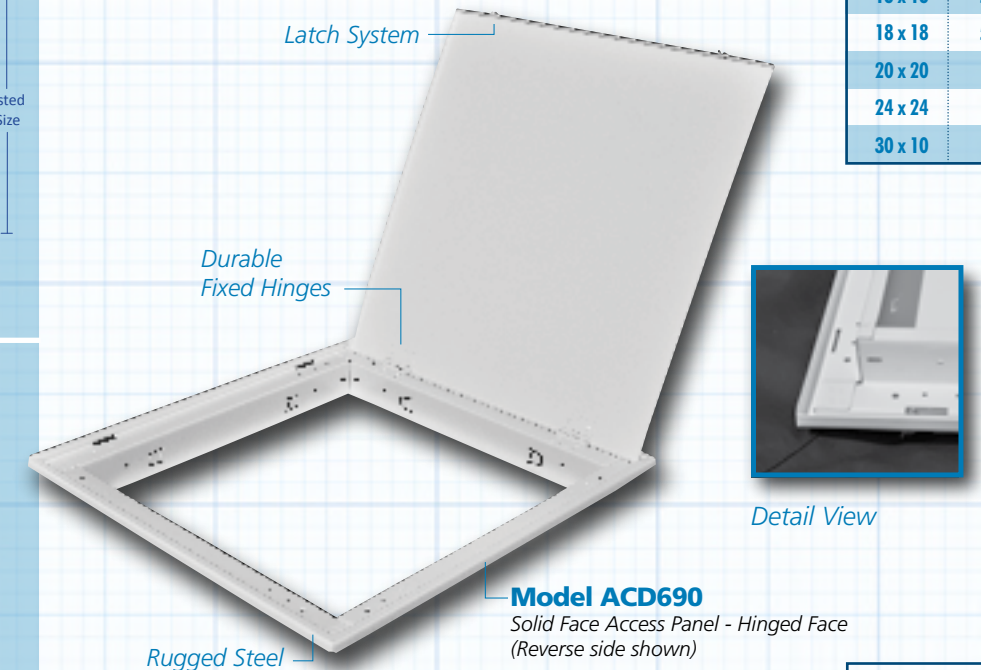

Model ACD690

SIZE	CARTON QTY.
10 x 10	10
12 x 12	10
14 x 14	10
16 x 16	5
18 x 18	5
20 x 20	1
24 x 24	1
30 x 10	1

Model 670

SIZE	CARTON QTY.
10 x 10	20
12 x 12	20
14 x 14	20
16 x 16	10

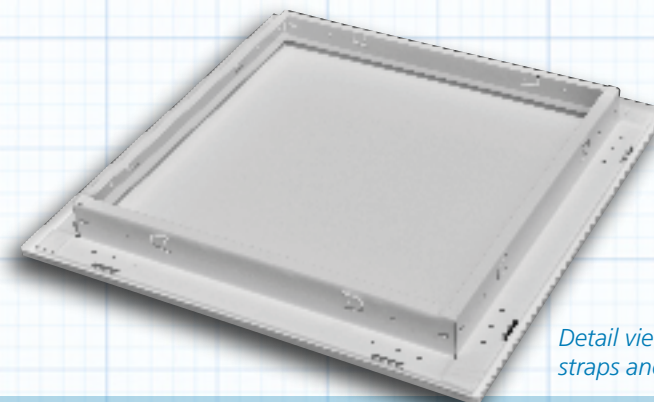

Detail view showing seismic straps and mounting options.

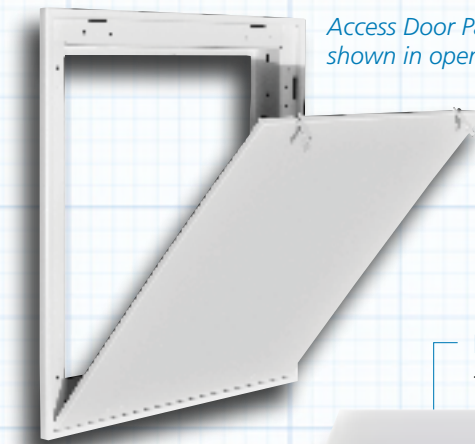

Access Door Panel shown in open position

Model Number Specifications **ACD690 18 X 18**

Type of Access
Blank = Screw Mounted Panel
ACD = Hinged Door
Access Style
690 = Small Hinged
670 = Screw Mount

Access Door Height
Access Door Width

Detail showing recessed screw holes. Model mounts using two supplied screws.

ACD2400 Series

TRUaire's ACD2400 series split access doors are an economical and attractive access door for ceilings and are manufactured using the highest quality materials to provide strength and durability. TRUaire's ACD2400 split access doors are ideally suited for apartment, condominiums and office building where easy access to mechanical equipment located above a ceiling is required. These access doors are split into three sections, allowing the center section to be opened without opening the side sections.

These access panels can be ordered with a solid face or a louvered return air filter grille each having concealed fixed hinges and easy-open SmoothGlide Technology finger latches.

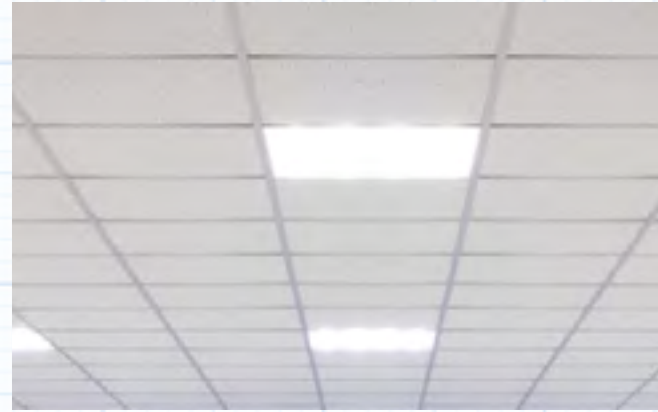

Features

- Steel construction
- Unique segmented face design
- Easy filter access
- Completely removable panels
- Center panel is louvered or solid face
- SmoothGlide finger latches
- Pristine white powder coat finish

Product Detail



1. All Panels Closed



2. Center Panel Open



3. Center & Left Panel Open



Model ACD2440S
Solid Face Access Panel

Model ACD2440L
Louvered Face Access Panel

ACD2400 Series Options

Model ACD2440L (Louvered)
Louvered center panel is used for non-ducted return air applications.



Shown in closed position

Model ACD2440S (Solid)
The solid center panel is used for ducted return air applications.

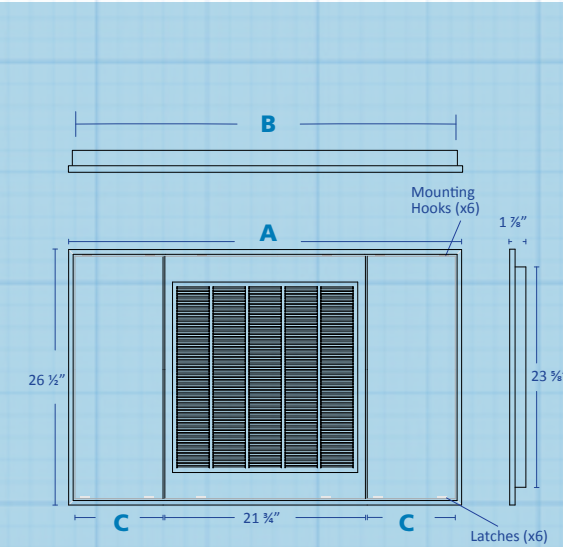
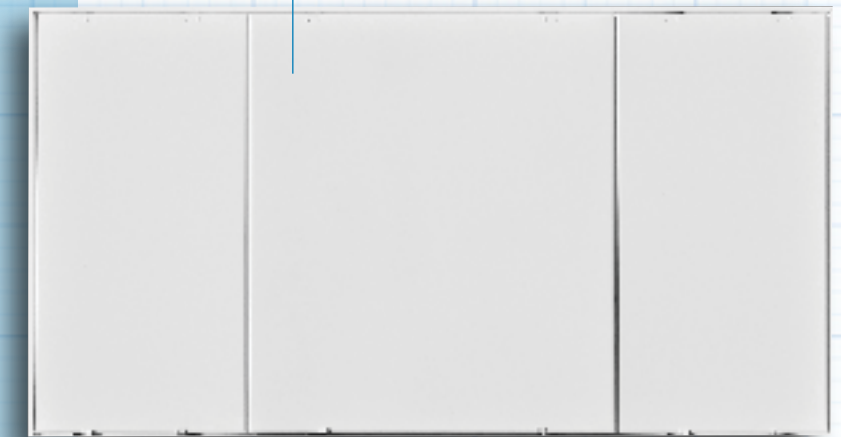

ACD2400 Series Dimensions			
MODEL	A	B	C
2440	46 1/2"	39 5/8"	9 3/4"
2446	48 1/2"	45 5/8"	12 3/4"
2452	54 1/2"	51 5/8"	15 3/4"
2460	62 1/2"	59 5/8"	19 3/4"

Model Number Specifications

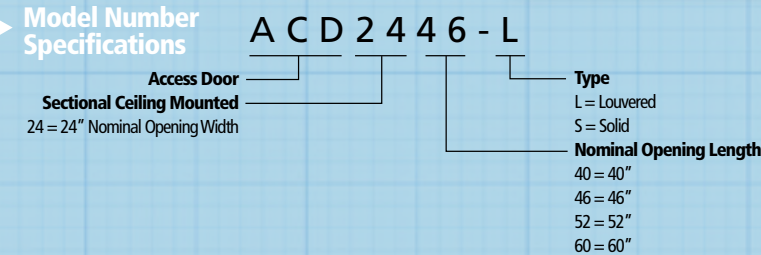

SmoothGlide™ Latch Technology



ACP Series

Truairé's ACP series access ceiling panels are designed to allow access to HVAC equipment located above hard cast ceilings. These access ceiling panels come in either a return air filter grille style or a solid panel style. The return air filter grille style can be ordered with one or two 18" x 18" nominal louvered panels. The main access panel is held closed to the frame by thumb screws. The access ceiling panel installs flush on to the drywall which has been applied directly below the HVAC equipment.



Model ACP-L

Louvered Ceiling Access Panel



Model ACP-S

Solid Ceiling Access Panel



Features

- Steel construction
- Hinged main panel
- Separate hinged filter access on LF
- 1/2" blade spacing on LF Models
- 40° blade pitch on LF Models
- SmoothGlide finger latches on filter access
- Pristine white powder coat finish

Product Detail



Durable, Mitered Corner

Model ACP-L Louvered Ceiling Access Panel

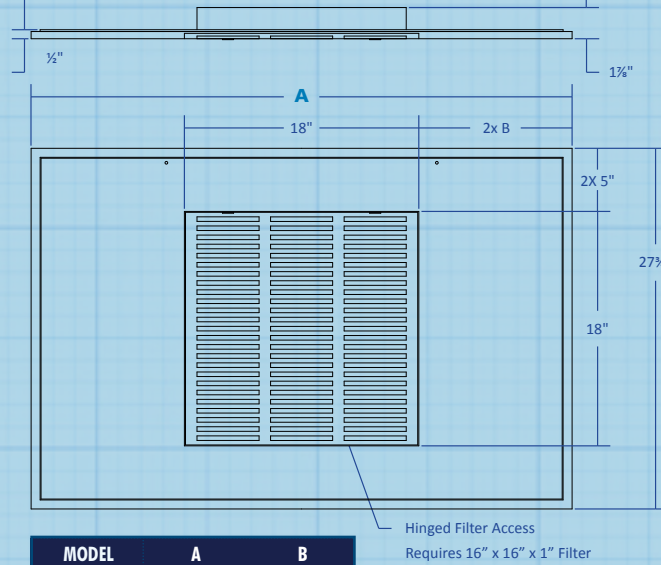

MODEL	A	B
ACP2844-LF1	43 1/4"	12 5/8"
ACP2850-LF1	49 1/4"	15 5/8"
ACP2856-LF1	55 3/4"	18 7/8"

Model ACP-LF Solid Ceiling Access Panel

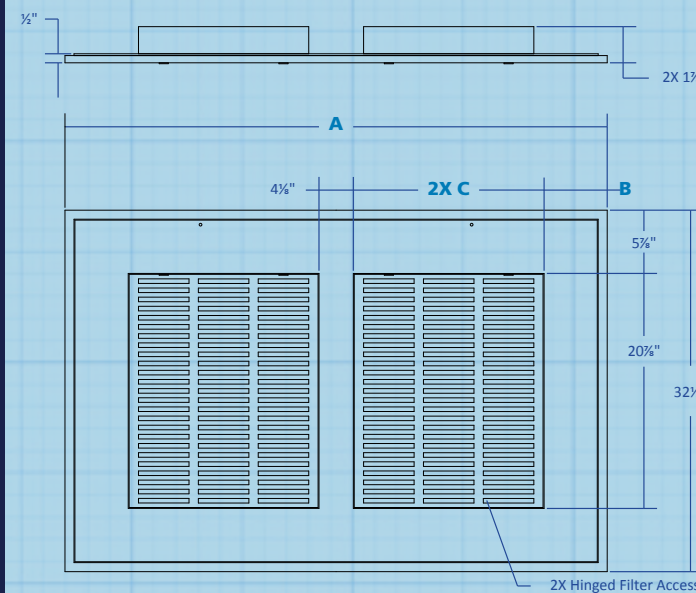

MODEL	A	B	C	FILTERS
ACP3348-LF2	43"	5 1/16"	16 7/8"	(2) 18" x 14" x 1
ACP3360-LF2	60"	7 1/16"	20 7/8"	(2) 18" x 18" x 1

Model Number Specifications

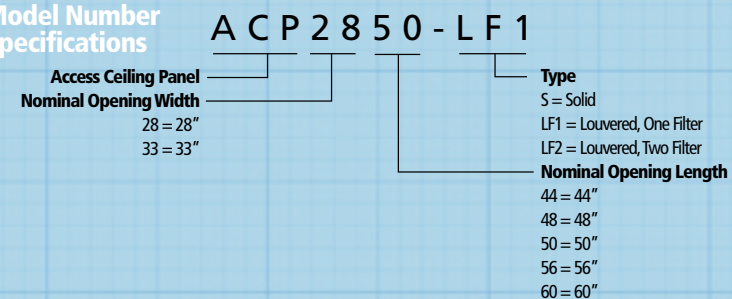

ACP Series Features

Model ACP-L (Louvered)

Louvered center panel is used for non-ducted return air applications.

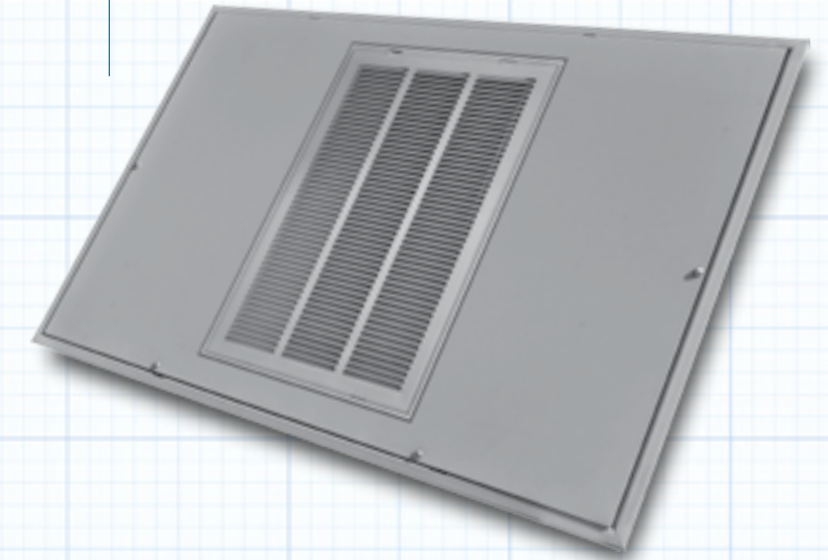

Model ACP-S (Solid)

The solid center panel is used for ducted return air applications.

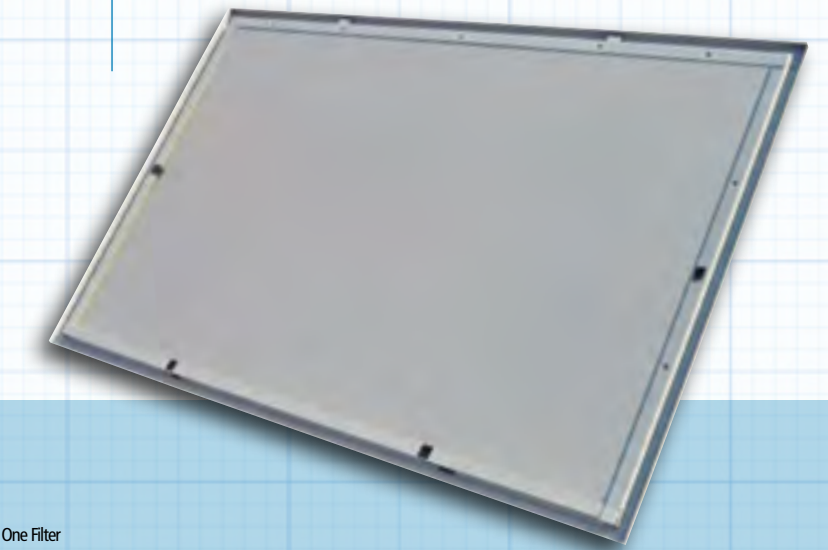

AWD Series

TRUaire's AWD series access wall doors are designed to allow access to HVAC equipment located behind walls. These access wall doors come in either a return air panel or a solid panel. The return air panel has stamped louvers on the bottom portion with filter access achieved by removal of the panel. The panel secures to the frame by tabs on the bottom edge and two quarter-turn fasteners in the upper corners. The access wall door installs flush on to the drywall which has been applied directly in front of the HVAC equipment.



Model AWD-L
Wall Access Door Panel

Features

- Steel construction
- 5/8" blade spacing
- 20° blade pitch
- Pristine white powder coat finish

Model AWD-S
Wall Access Door Panel



Product Detail



Stamped Louver Blades

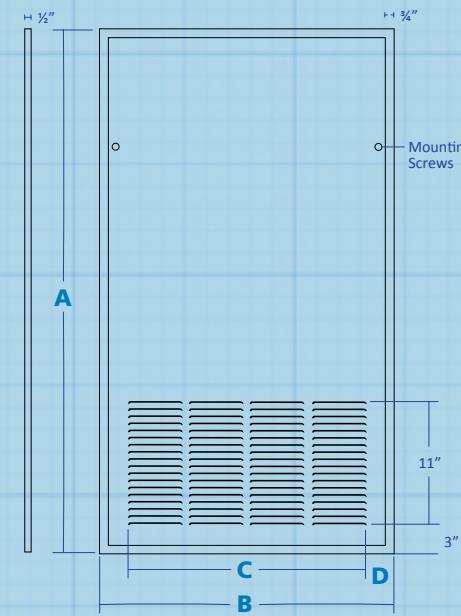

MODEL	A	B	C	D
AWD 4324-L	43 1/8"	24 3/8"	15 7/8	4 1/4
AWD 4828-L	47 5/8"	27 1/2"	21 3/8	3



MODEL	A	B
AWD 4324-S	43 1/8"	24 3/8"
AWD 4828-S	47 5/8"	27 1/2"

Model Number Specifications

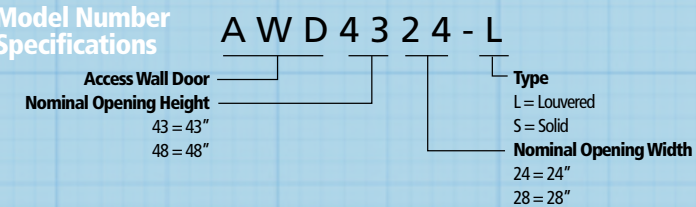

AWD Series Features

Model AWD-1L (Louvered)

Louvered center panel is used for non-ducted return air applications.

Shown in closed position

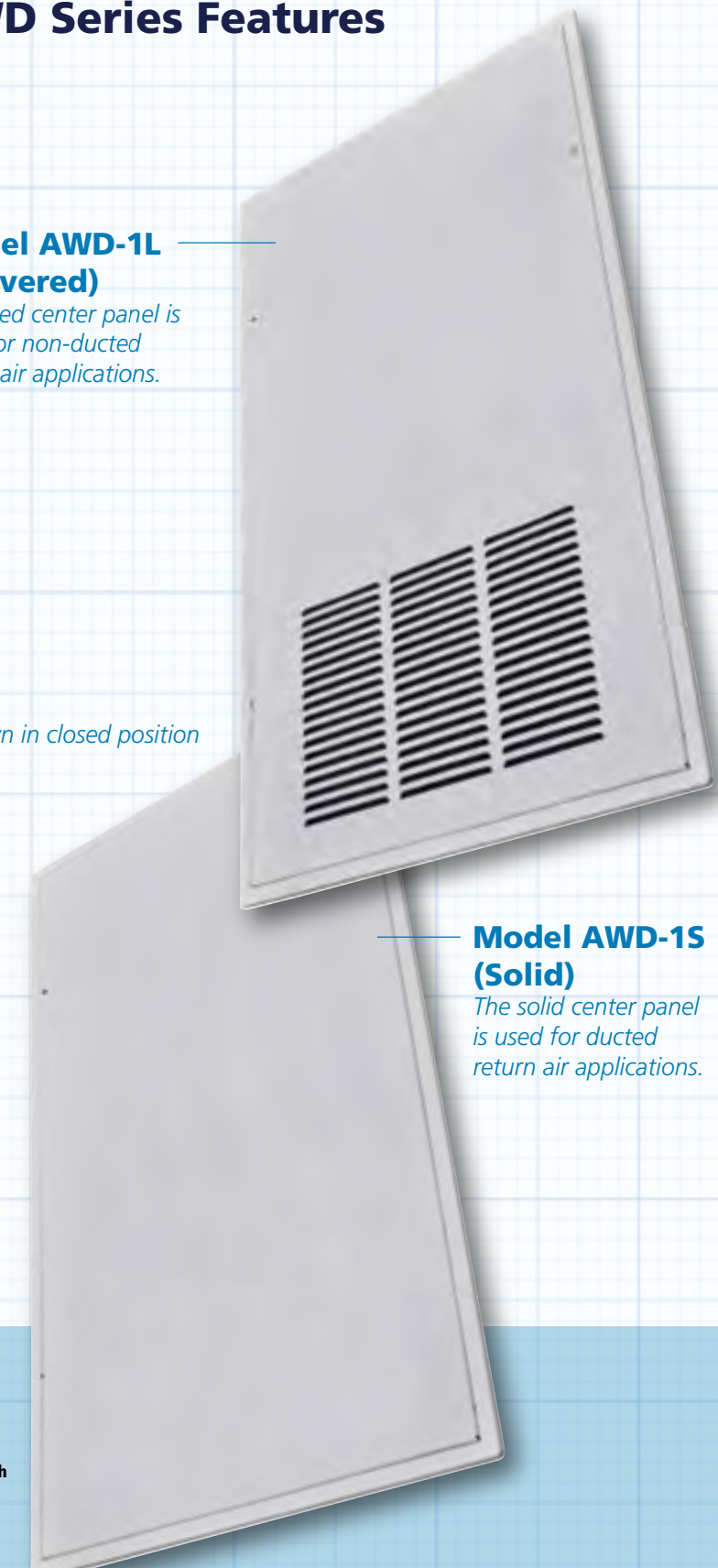

Model AWD-1S (Solid)

The solid center panel is used for ducted return air applications.

Model 801

Butterfly damper & installation ring

Truair's 801 combination butterfly damper and mounting ring allows the installation of the 800 series with a damper. Truair's 801 butterfly damper and mounting rings are manufactured using the highest quality materials to provide strength and durability. These combination butterfly dampers and mounting rings are offered from 6" diameter to 18" diameter, increments of 2". These butterfly dampers are opened and closed using either the tee handle half round adjustment tool supplied with butterfly damper or a regular flat blade screwdriver through the face of the diffuser. These combination butterfly damper and mounting rings are made entirely out of steel and are powder coated a durable brown finish and come supplied with half round tee handle adjustment tool.

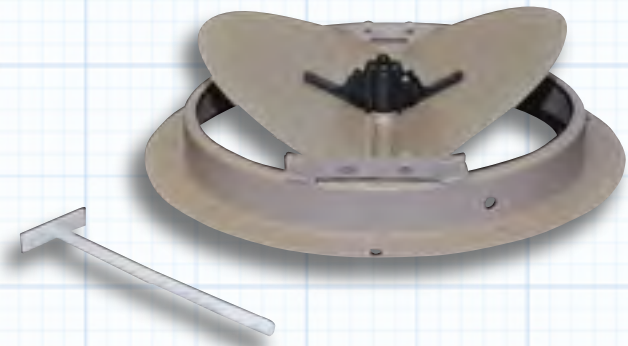

Model 802

Butterfly damper

Truair's 802 butterfly dampers mount directly onto the round neck of the diffusers or grille for a means of volume control for effective air balancing. Truair's 802 butterfly dampers are manufactured using the highest quality materials to provide strength and durability. These round butterfly dampers are offered from 6" diameter to 18" diameter, increments of 2". These butterfly dampers are opened and closed using either the tee handle half round adjustment tool supplied with butterfly damper or a regular flat blade screwdriver through the face of the diffuser. These butterfly dampers blades are made from steel and are powder coated a durable brown finish and come supplied with half round tee handle adjustment tool.

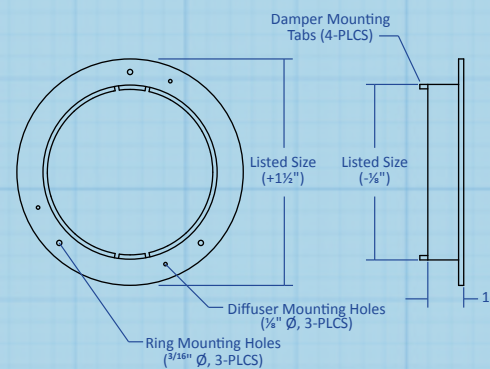
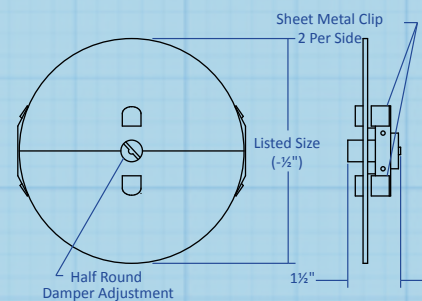
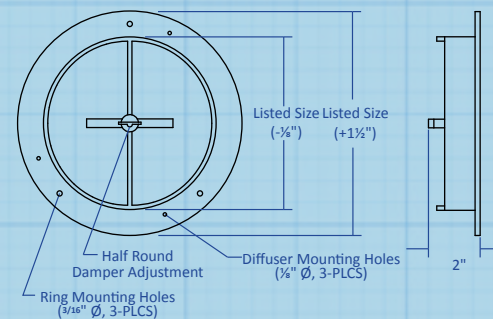
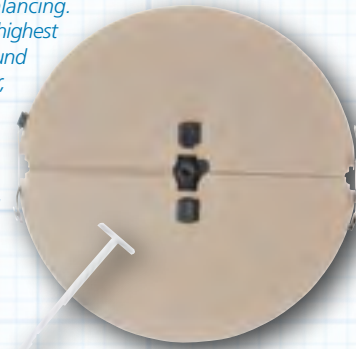

Model 803

Mounting Ring

Truair's 803 mounting ring allows the installation of the 800 series without a damper. Truair's 803 mounting rings are manufactured using the highest quality materials to provide strength and durability. These mounting rings are offered from 6" diameter to 18" diameter, increments of 2". These mounting rings are made entirely out of steel and are powder coated a durable brown finish and come supplied with the mounting screws.

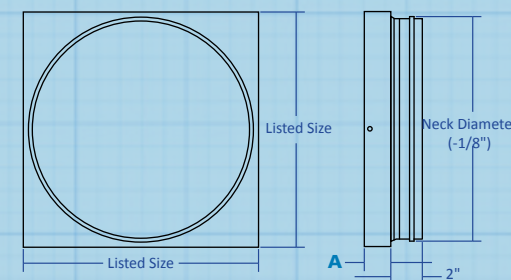
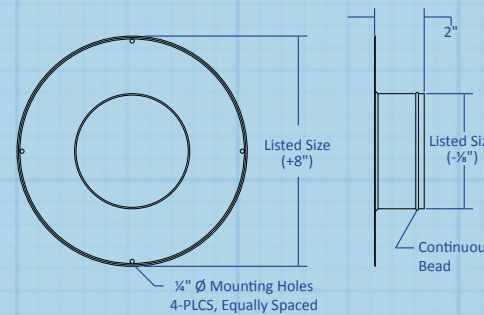
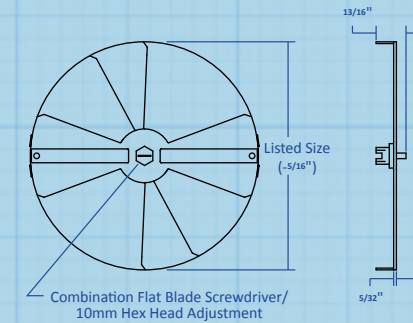
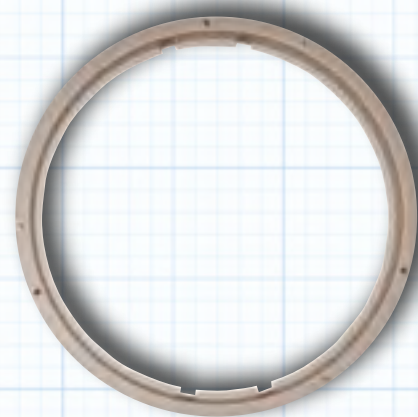

DAMPER OPTION	A
With Damper	4"
Without Damper	2"

Model 804

Radial Damper

Truair's 804 radial dampers mount directly onto the round neck of the diffusers or grille for a means of volume control for effective air balancing. Truair's 804 radial dampers are manufactured using the highest quality materials to provide strength and durability. These round radial dampers are offered from 6" diameter to 18" diameter, increments of 2". These radial dampers are opened and closed using either the tee handle 10mm hex head adjustment tool supplied with radial damper or a regular flat blade screwdriver through the face of the diffuser. The blades of the radial damper slide at right angles to the duct. These radial dampers blades are made entirely from electro-galvanized steel for corrosion resistance and come supplied with a 10mm hex head tee handle adjustment tool.

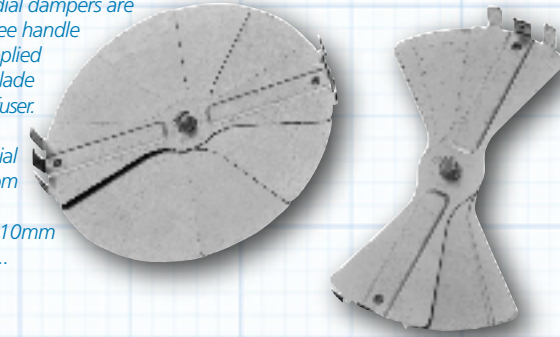

Model 820

Ring Collar

Truair's 820 Ring Collar has a unique snap-in design which helps with ease of installation. Truair's 820 ring collars are manufactured using the highest quality materials to provide strength and durability. These ring collars have a 2" high beaded duct collar for superior strength as well as retention for flexible duct connections. These ring collars are made entirely from electro-galvanized steel for corrosion resistance.



Model 821

Push Pin Fasteners

- Push pins come in packages of 20. (Please order in quantities divisible by 20)
- Used with Model 820 pictured above



Model SQRD

Square to Round Transition

Truair's SQRD square-to-round transitions allow the installation of round or flexible duct to square neck diffusers. Truair's SQRD square-to-round transitions are manufactured using the highest quality materials to provide strength and durability. These square-to-round transitions have a 2" high beaded duct collar for superior strength as well as retention for flexible duct connections. These square-to-round transitions come in two depths, 2" deep for connecting directly to the diffuser and 4" deep for when the diffuser requires a control damper. These square-to-rounds are made entirely from electro-galvanized steel for corrosion resistance.

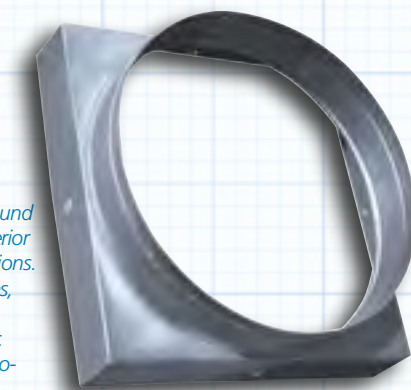

Model 5000XF
Surface Mounting Frame

Truair's 5000XF aluminum surface mounting frames allow the installation of T-bar style diffusers and grilles into plaster or gypsum board hard cast ceilings. Truair's 5000XF surface mounting frames are manufactured using the highest quality materials to provide strength and durability. The surface mounting frame comes in four different sizes. Diffuser or grille with flex connection can be lifted out of frame to access ceiling space. The surface mount frames are made entirely out of extruded aluminum and are powder coated a durable pristine white finish and come supplied with corresponding mounting screws.

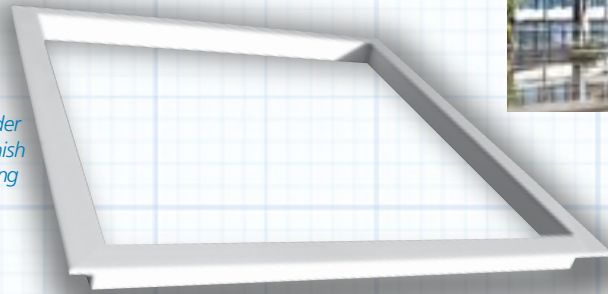

SIZE	A	B	C	D	E	F
12 x 12	14"	14"	12 1/16"	12 1/16"	11 1/8"	11 1/8"
24 x 12	26"	14"	24 1/16"	12 1/16"	23 1/8"	11 1/8"
24 x 24	26"	26"	24 1/16"	24 1/16"	23 1/8"	23 1/8"
24 x 48	26"	50"	24 1/16"	48 1/16"	23 1/8"	47 1/8"

Model AL-OBD
Aluminum Opposed Blade Damper

Truair's AL-OBD aluminum opposed blade dampers mount directly to the neck of the diffuser or grille for a means of volume control for effective air balancing. Truair's AL-OBD aluminum opposed blade dampers are manufactured using the highest quality materials to provide strength and durability. These aluminum opposed blade dampers are opened and closed by a screwdriver adjustment which is accessible through the face of the registers. These aluminum opposed blade dampers are made entirely from extruded aluminum and have durable nylon bushings to ensure blades stay in place and do not rattle.

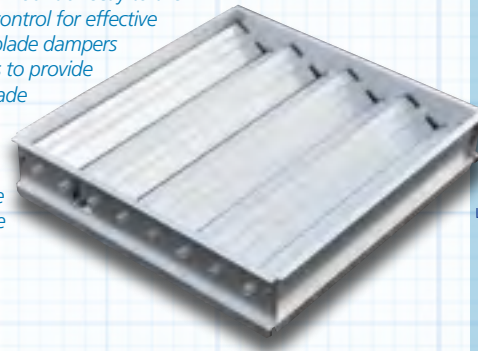

Outside



Model 1056FB
Insulated Back

Truair's 1056FB series insulated back is designed to prevent the back pans of the T-Bar Lay-In style grilles and diffusers from sweating. Truair's 1056FB insulated backs are manufactured using the highest quality materials to provide strength and durability. These insulated backs are made of 1/2" fiberglass insulation that has an aluminum foil vapor barrier bonded to the back side and are molded to fit the contour of the back pan.



Inside

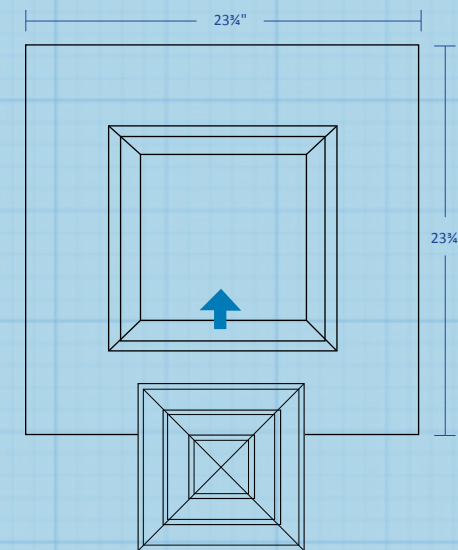
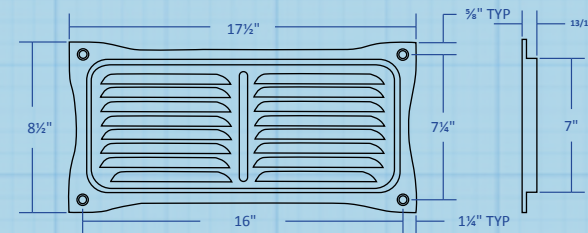
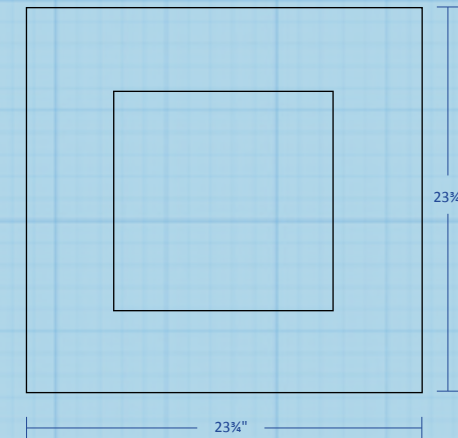
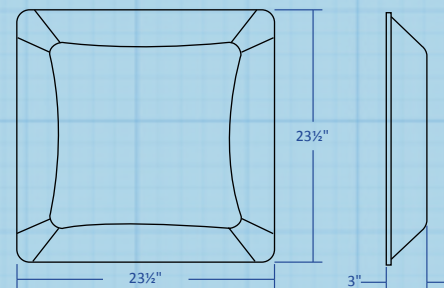
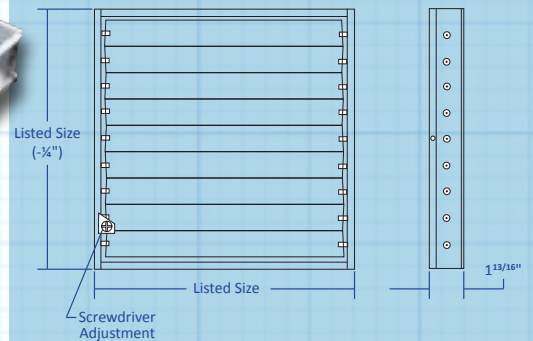
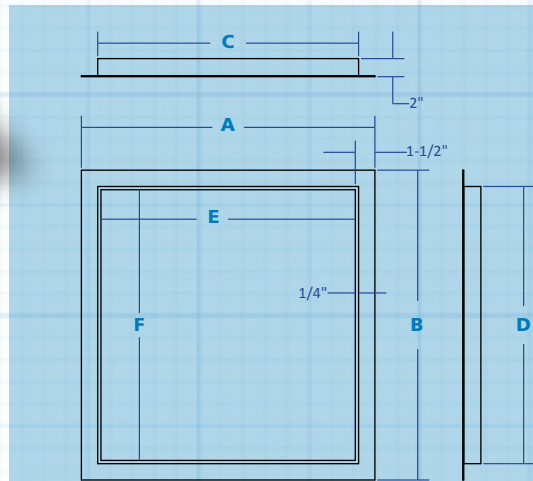

Model 5000P
T-Bar Panel

Truair's 5000P series T-Bar panels are designed to accept A500 series diffusers. Truair's 5000P series T-Bar panels are manufactured using the highest quality materials to provide strength and durability. These T-Bar panels have a pre-punched square hole on center for the field mounting of the A500 series diffusers. These 5000P series T-Bar panels are made from steel and are powder coated a nice, durable pristine white.

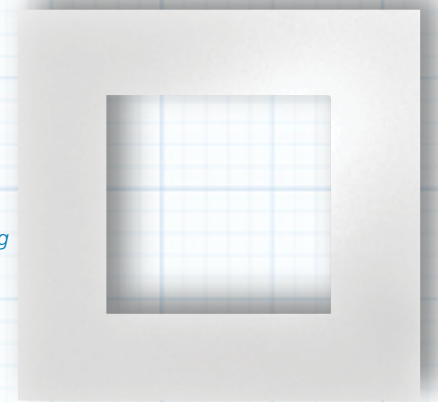

Model FV640G
Louvered Foundation Vent

Truair's FV640G series foundation vents are designed to keep crawl spaces dry and allow light to enter. When moisture build-up is reduced, so are the chances of rot, mildew, instability and pest infestations such as termites. Truair's FV640G series are manufactured using the highest quality materials to provide strength and durability. These foundation vents are stamped out of a single piece of 26-gauge electro-galvanized steel. The FV640G series foundation vents are ideally suited for stucco and exterior applications.

Model FV640G

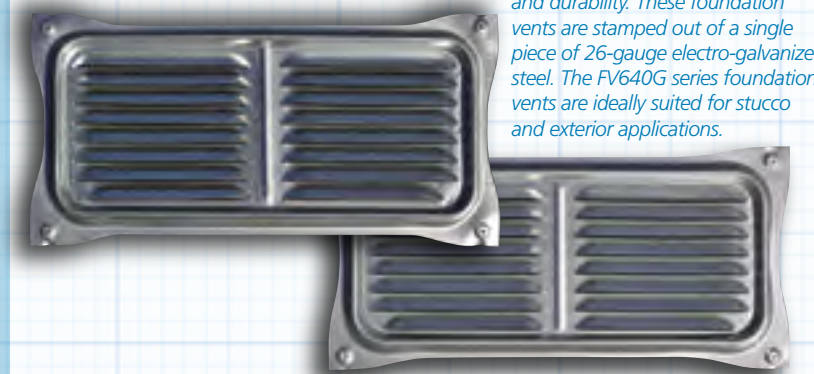

Model FV640GS - Louvered Foundation Vent

- Shown with and without wire mesh backing. Please specify your preference when ordering.

5400SD Series
T-Bar Panel

Truair's 5400SD series T-Bar panels are designed to accept A540 series diffuser's center cores. Truair's 5400SD series T-Bar panels are manufactured using the highest quality materials to provide strength and durability. These T-Bar panels have the diffuser frame mounted on a steel panel. These 5400SD series T-Bar panels are powder coated a durable pristine white.

