

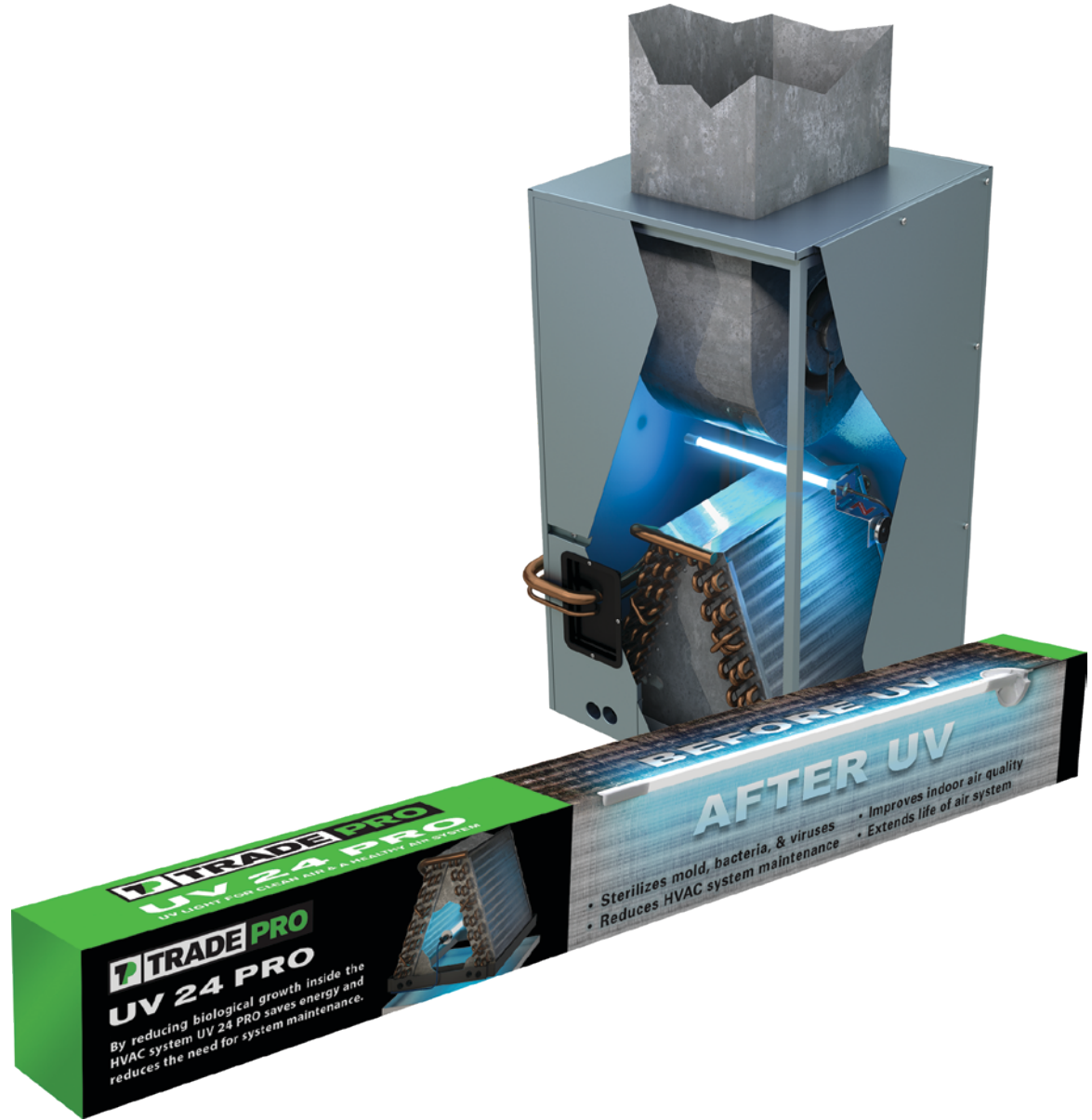

FOR INDUSTRY PROFESSIONALS



GERMICIDAL UV LIGHT

Features and Benefits

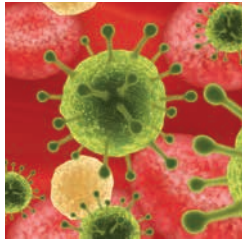

VIRUSES



BACTERIA

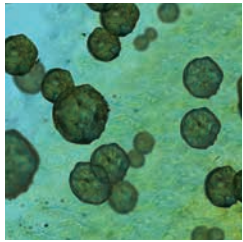

MOLD

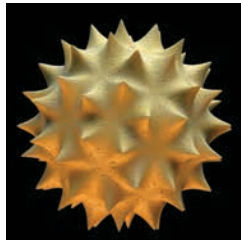

ALLERGENS

STERILIZES BIOLOGICAL PATHOGENS

Germicidal UV Light is proven to sterilize all types of biological contaminants after just a few seconds of exposure.



24 VAC ELECTRONIC POWER SUPPLY

Easy to install low-voltage 24 VAC electronic power supply connects to HVAC system internal power.

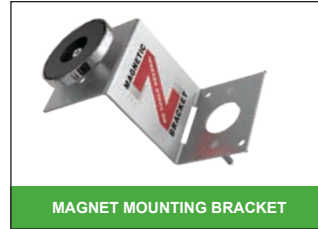

MAGNET MOUNTING BRACKET

Magnetic Z-Bracket for quick mounting onto metal surfaces. Base snaps off for A-plate mounting with screws.



TPUVL UVC LAMP

100% 254 NM germicidal UVC spectrum lamp with Unshielded quartz hot filament. Effective for one year.



TPUVL-OS UVC LAMP

90% Standard 254 NM Germicidal UVC, 10% 185 NM Odor Oxidation. Unshielded quartz hot filament. Effective for one year.



DISINFECTS THE AIR & HVAC SYSTEM SURFACES

The TradePro Germicidal UV light is ideal for both furnaces and air handlers. Installing the light near the coils keeps them free of mold which saves energy and extends the life of the HVAC system. It also improves indoor air quality by sterilizing airborne biological pathogens such as viruses, bacteria, and allergens.

TradePro UV Specs

Part #	TP-UV24-PRO
UVC Lamp	TPUVL 100% 254 NM Germicidal UVC Spectrum Unshielded Quartz Hot Filament Effective 1 Year
Part #	TP-UV24OS-PRO
UVC Lamp	TPUVL-OS 90% Standard 254 NM Germicidal UVC 10% 185 NM Odor Oxidation Unshielded Quartz Hot Filament Effective 1 Year
COMMON	
Dimensions	Lamp: 15"L x 0.74" Dia. Power Supply: 4.2"L x 1.8" W x 1"D
Weight	Weight - 1 lb.
Electrical	24 VAC +/- 20%, 60 Hz, 0. 68 Amps, 16 VA
Kit Includes	Power Supply, 6' Lamp Cable, UV Lamp, Magnetic 'Z' Mounting Bracket, Mounting Hardware, Panel Indicator
Warranty	UV Lamp: 90 Days Power Supply: 1 Year

- A** UVC Lamp
- B** Magnetic Z-Bracket
- C** Lamp Cable
- D** Electronic Power Supply
- E** Lamp connector

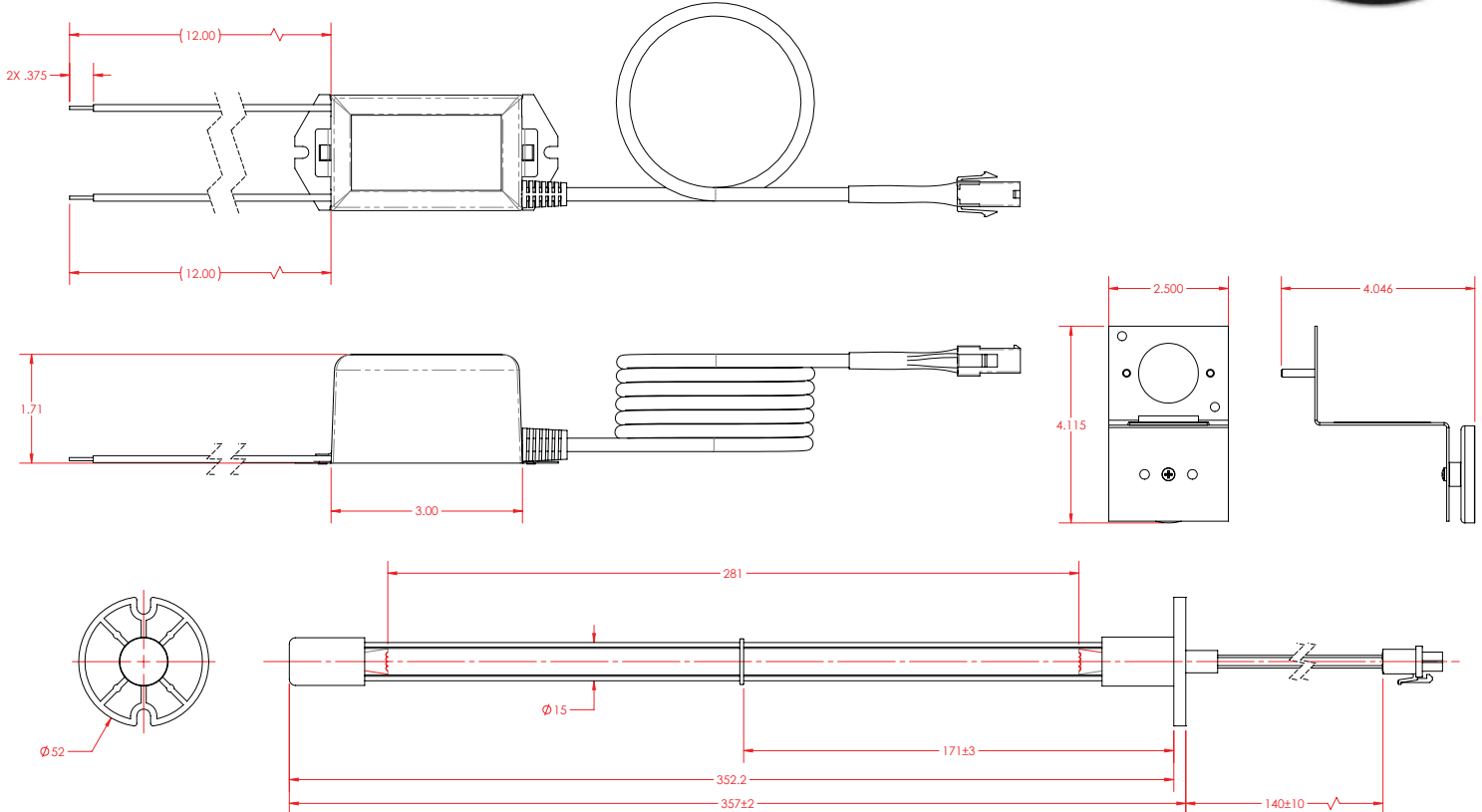
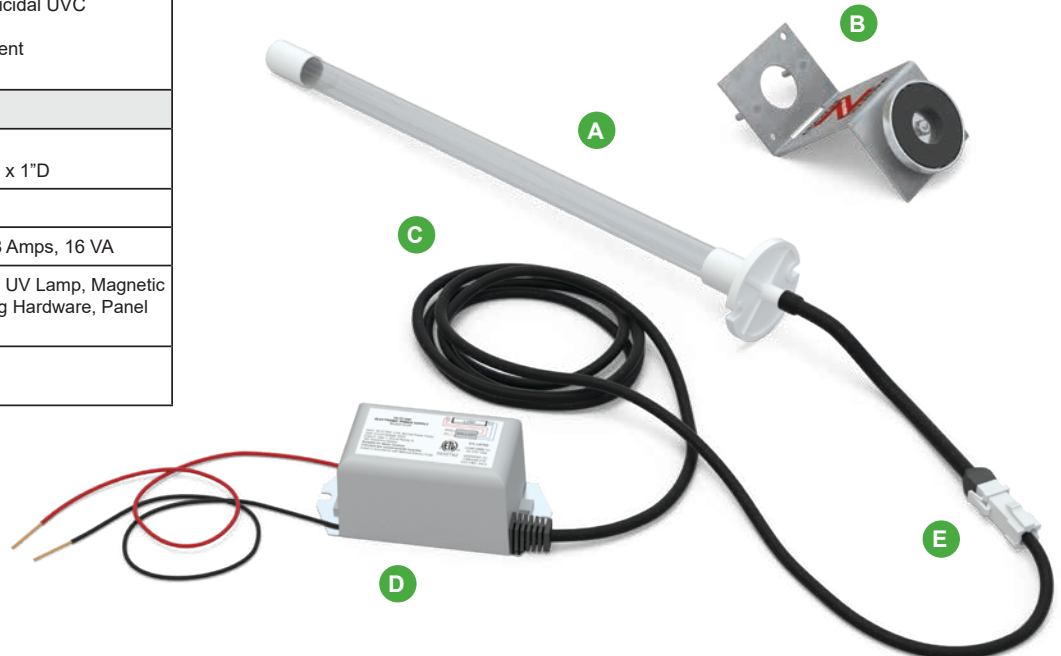

Why Sell TradePro Germicidal UV Lights

TradePro Germicidal UV Lights extend the life of the HVAC system and save energy by reducing biofilm on cooling coils. They also improve indoor air quality by sterilizing airborne biological contaminants such as viruses, bacteria, mold, and allergens.

UVC disinfection is a proven technology that has been used for over a century in hospitals, water treatment facilities, and agriculture.

TradePro Germicidal UV Light systems are similar in form and function to the popular Blue-Tube UV from Fresh-Aire UV.

TradePro UV Specs

Part #	TP-UV24-PRO
UVC Lamp	TPUVL-OS 100% 254 NM Germicidal UVC Spectrum Unshielded Quartz Hot Filament Effective 1 Year
Part #	TP-UV24OS-PRO
UVC Lamp	TPUVL-OS 90% Standard 254 NM Germicidal UVC 10% 185 NM Odor Oxidation Unshielded Quartz Hot Filament Effective 1 Year
	COMMON
Dimensions	Lamp: 15"L x 0.74" Dia. Power Supply: 4.2'L x 1.8"W x 1"D
Weight	Weight - 1 lb.
Electrical	24 VAC +/- 20%, 60 Hz, 0.68 Amps, 16 VA
Kit Includes	Power Supply, 6' Lamp Cable, UV Lamp, Magnetic 'Z' Mounting Bracket, Mounting Hardware, Panel Indicator
Warranty	UV Lamp: 90 Days Power Supply: 1 Year

Blue-Tube UV Specs

UV Lamp	254 nm germicidal UV-C, quartz hot filament	
Dimensions	Lamp: 15"L x 0.74" Dia. ER Power Supply: 4.1"W x 1.7" H x 1.8"D ST Power Supply: 5.0"W x 1.1" H x 2.4"D	
ER models Electrical	18-32 VAC, 60 Hz, 0.68 Amps, 16 VA	
SI/DI models Electrical	120-277 VAC, 50/60 Hz, 0.41 amp/120V thru 0.18amp/277V	
Kit Includes	Power Supply, 6' Lamp Cable, UV Lamp, Magnetic 'Z' Bracket, Mounting Hardware, Panel Indicator, Installation Slicker	
Warranty	Lifetime for all parts except lamp	
US Patent #	7,704,463	
Part Numbers		
18-32 VAC		
TUV-BTER	1 Year Lamp	TUVL-115P
TUV-BTER2	2 Year Lamp	TUVL-215P
120-277 VAC		
TUV-BTST	1 Year Lamps	TUVL-115P
TUV-BTST2	2 Year Lamps	TUVL-215P