

### 13 SEER, R-410A

### PACKAGE HEAT PUMP FOR MANUFACTURED HOUSING, RESIDENTIAL, AND LIGHT COMMERCIAL APPLICATIONS 2 – 5 TONS

### Single Phase, 208/230 V, 60 Hz

#### BUILT TO LAST, EASY TO INSTALL AND SERVICE

- Compact, fully self-contained, electric cooling unit with horizontal supply and return ducts
- Light weight, compact construction ideal for manufactured housing and residential applications
- Environmentally sound R-410A refrigerant
- Vibration isolation provides quiet operation. Compressors have internal over current protection
- Liquid refrigerant filter driers
- Hand holds built into the unit base pan
- Designed to be serviced from both the side and front
- Accessory electric heaters with single point connections
- Durable pre-painted steel cabinet
- No-rust base pan with integrated drain pan standard on all units
- Direct-drive ECM multispeed, blower motor standard on all models
- Louvered coil enclosure for protection against vandalism and hail damage
- Aerodynamic fan blade design reduces the overall sound
- All models available with optional factory installed tin-coated copper evaporator coil. (These models are identified with letters TP in the 11th and 12th positions in the model numbers)



#### LIMITED WARRANTY\*

- 5-year parts limited warranty (including compressor and coils)  
–With timely registration, an additional 5 year parts limited warranty (including compressor and coils)
- \*Applies to original purchaser/homeowner, some limitations may apply. See warranty certificate for details.



Use of the AHRI Certified TM Mark indicates a manufacturer's participation in the program. For verification of certification for individual products, go to [www.ahrirectory.org](http://www.ahrirectory.org).



#### UNIT PERFORMANCE DATA

Model Number	COOLING			HEATING		Unit Dimensions H x W x D in [mm]	Operating Weight lbs [kg]
	Capacity BTU/h	SEER	EER	NET HEATING CAPACITY	HSPF		
PHJ324000K000A PHJ324000KTP0A	24,000	13.5	11.5	23,800	7.7	30 [765]x51 [1295]x32 [813]	263 [120]
PHJ330000K000A PHJ330000KTP0A	28,800	13.5	11.5	28,600	7.7	30 [765]x51 [1295]x32 [813]	264 [120]
PHJ336000K000A PHJ336000KTP0A	36,000	13.5	11.5	34,400	7.7	34 [867]x51 [1295]x32 [813]	285 [130]
PHJ342000K000A PHJ342000KTP0A	41,500	13.5	11.5	41,000	7.7	42 [1070]x51 [1295]x32 [813]	339 [154]
PHJ348000K000A PHJ348000KTP0A	46,500	13.5	11.5	46,500	7.7	42 [1070]x51 [1295]x32 [813]	358 [163]
PHJ360000K000A PHJ360000KTP0A	55,000	13.0	11.0	55,000	7.7	42 [1070]x51 [1295]x32 [813]	371 [169]

MODEL NOMENCLATURE									
MODEL SERIES	1	2, 3	4	5,6	7,8,9	10	11,12	13	14
	<b>P</b>	<b>HJ</b>	<b>3</b>	<b>36</b>	<b>000</b>	<b>K</b>	<b>00</b>	<b>0</b>	<b>A</b>
P = Package									
HJ = Heat Pump									
3 = 13			<b>SEER</b>						
24 = 2 Tons									
30 = 2.5 Tons									
36 = 3 Tons									
42 = 3.5 Tons									
48 = 4 Tons									
60 = 5 Tons				<b>NOMINAL COOLING CAPACITY</b>					
000 = no factory heat					<b>NOMINAL HEATING BTUH (input)</b>				
K = 208/230-1-60						<b>VOLTAGE</b>			
00 = No options									
TP – Tin Plated Evaporator Main Tubes							<b>FACTORY INSTALLED OPTIONS</b>		
0 = Standard									<b>FEATURE CODE</b>
Sales Model Digit									

### AHRI CAPACITY RATINGS – COOLING CAPACITIES AND EFFICIENCIES

PHJ3	NOMINAL TONS	STANDARD CFM	NET COOLING CAPACITY AT 95°F (35°C) (Btuh)	EER†	SEER**
24	2	800	24,000	11.5	13.5
30	2.5	1000	28,800	11.5	13.5
36	3	1200	36,000	11.5	13.5
42	3.5	1400	41,500	11.5	13.5
48	4	1600	46,500	11.5	13.5
60	5	1750	55,000	11.0	13.0

### AHRI CAPACITY RATINGS – HEATING CAPACITIES AND EFFICIENCIES

PHJ3	NET HEATING CAPACITY AT 47°F (8.3°C) (Btuh)	COP @ 17°F (-8.3°C)	NET HEATING CAPACITY AT 17°F (-8.3°C) (Btuh)	COP @ 17°F (-8.3°C)	HSPF**
24	23,800	3.7	13,200	2.3	7.7
30	28,600	3.7	15,600	2.3	7.7
36	34,400	3.5	18,800	2.2	7.7
42	41,000	3.6	23,200	2.3	7.7
48	46,500	3.6	27,000	2.3	7.7
60	55,000	3.4	31,800	2.2	7.7

**LEGEND**

dB—Sound Levels (decibels)

db—Dry Bulb

SEER—Seasonal Energy Efficiency Ratio

wb—Wet Bulb

COP—Coefficient of Performance

\* Air Conditioning Heating & Refrigeration Institute

† At "A" conditions—80°F (26.7°C) indoor db/67°F

(19.4°C) indoor wb & 95°F (35°C) outdoor db.

\*\* Rated in accordance with U.S. Government DOE

Department of Energy) test procedures and/or AHRI Standards

210/240-08.

**Notes:**

1. Ratings are net values, reflecting the effects of circulating fan heat.

Ratings are based on:

Cooling Standard: 80°F (26.7°C) db, 67°Fwb (19.4°C) indoor entering–air

temperature and 95°F db (35°C) outdoor entering–air temperature.

2. Before purchasing this appliance, read important energy cost and efficiency

information available from your retailer.



Use of the AHRI Certified TM Mark indicates a manufacturer's participation in the program For verification of certification for individual products, go to [www.ahridirectory.org](http://www.ahridirectory.org).



### A-Weighted Sound Power Level (dBA)

PHJ3	STANDARD RATING (dBA)	TYPICAL OCTAVE BAND SPECTRUM (dBA without tone adjustment)						
		125	250	500	1000	2000	4000	8000
24	73	61	63.5	68	65.5	59	52	46
30	74	65.5	63	65	64.5	61	56.5	53.5
36	75	64.5	68.5	69.5	69	64.5	59	51.5
42	77	70.5	67	72	70.5	65	60	51.5
48	76	68.5	70	70	70	65.5	60.5	53.5
60	79	66	71.5	72.5	74	70.5	65.5	57.5

<b>PHYSICAL DATA – PHJ3</b>						
<b>UNIT SIZE</b>	<b>24</b>	<b>30</b>	<b>36</b>	<b>42</b>	<b>48</b>	<b>60</b>
<b>NOMINAL CAPACITY (ton)</b>	2	2.5	3	3.5	4	5
<b>SHIPPING WEIGHT (lb)</b>	312	314	334	388	407	420
<b>(kg)</b>	142	143	152	177	185	191
<b>COMPRESSOR TYPE</b>	SCROLL					
<b>REFRIGERANT</b>	R-410A					
<b>REFRIGERANT QUANTITY (lb)</b>	5.50	6.70	5.85	7.00	7.50	8.50
<b>QUANTITY (kg)</b>	2.49	3.04	2.65	3.18	3.40	3.86
<b>OUTDOOR METERING DEVICE</b>	Piston					
<b>ORIFICE OD (in.)</b>	0.049	0.049	0.057	0.061	0.067	0.073
<b>(mm)</b>	1.245	1.245	1.448	1.549	1.702	1.854
<b>OUTDOOR COIL ROWS...FINS/in.</b>	2...20	2...20	2...20	2...20	2...20	2...20
<b>FACE AREA (sq. ft)</b>	9.1	9.1	10.2	13.0	15.5	15.5
<b>OUTDOOR FAN NOMINAL AIRFLOW (cfm)</b>	2000	2000	2800	3100	2900	3200
<b>DIAMETER (in.)</b>	20	20	20	20	20	20
<b>DIAMETER (mm)</b>	508	508	508	508	508	508
<b>MOTOR HP (RPM)</b>	1/8 (825)	1/8 (825)	1/4 (1100)	1/4 (1100)	1/4 (1100)	1/3 (1110)
<b>INDOOR METERING DEVICE</b>	Piston					TXV
<b>ORIFICE OD (in.)</b>	0.059	0.059	0.067	0.073	0.080	N/A
<b>(mm)</b>	1.499	1.499	1.702	1.854	2.032	
<b>INDOOR COIL ROWS...FINS/in.</b>	3...12	3...12	3...12	3...12	3...12	3...12
<b>FACE AREA (sq. ft)</b>	4.3	4.3	4.9	4.9	4.9	6.1
<b>INDOOR BLOWER NOMINAL COOLING AIRFLOW (cfm)</b>	800	1000	1200	1400	1600	1750
<b>NOMINAL SIZE D x L (in.)</b>	10 x 8	10 x 8	11 x 9	11 x 9	11 x 10	11 x 10
<b>(mm)</b>	254 x 203	254 x 203	279 x 229	279 x 229	279 x 254	279 x 254
<b>MOTOR (HP)</b>	1/3	1/3	1/2	1/2	3/4	1
<b>HIGH-PRESSURE SWITCH (psig) CUTOUT RESET (AUTO)</b>	650 +/- 15 420 +/- 25					
<b>LOW-PRESSURE SWITCH (psig) CUTOUT RESET (AUTO)</b>	20 +/- 5 45 +/- 10					
<b>RETURN-AIR FILTERS THROWAWAY (in.) (mm)</b>	20x20x1 508x508x25	20x24x1 508x610x25	24x30x1 610x762x25		24x36x1 610x914x25	

\*Required filter sizes shown are based on the AHRI (Air Conditioning, Heating and Refrigeration Institute) rated airflow at a velocity of 300 ft/min for throwaway type or 450 ft/min for high capacity type. Recommended filters are 1-in. (25.4 mm) thick.

PHJ3 ACCESSORIES		
Accessory Model Number	Description	Use With
CPLOWAMB001A00	Motormaster® II Low Ambient Control	ALL
CPHSTART002A00	Compressor Start Kit	ALL
CPCRKHTR007A00	240V Crankcase Heater	24 – 36
NPCRKHTR004A00		42 – 60

ELECTRIC HEATERS				
Accessory Model Number	Nominal Capacity	Stages	Circuit Breaker	Use With
CPHEATER125A00	3.8 / 5.0	1	NO	24 – 42
CPHEATER126A00	3.8 / 5.0	1	YES	ALL
CPHEATER127A00	5.6 / 7.5	2	NO	24
CPHEATER128A00	5.6 / 7.5	2	YES	ALL
CPHEATER129A00	7.5 / 10.0	2	NO	NONE
CPHEATER130A00	7.5 / 10.0	2	YES	ALL
CPHEATER131A00	11.3 / 15.0	2	YES	36 – 60
CPHEATER132A00	15.0 / 20.0	2	YES	48 – 60

**Note:** If installing an accessory heater, the thermostat must have capability to energize "G" (fan) on a call for "W" (strip heat).

Multiplication Factors		
HEATER kW RATING	VOLTAGE DISTRIBUTION	MULTIPLICATION FACTOR
240	200	.69
	208	.75
	230	.92
	240	1.00

Example: 15.0 kW (at 240v) heater on 208v  
 = 15.0 (.75 mult factor)  
 = 11.25 capacity at 208v

# UNIT DIMENSIONS - PHJ324-36

UNIT	ELECTRICAL CHARACTERISTICS		UNIT WT.		UNIT HEIGHT		CENTER OF GRAVITY IN [MM]		
	LBS.	KG.	A	X	Y	Z	X	Y	Z
PHJ324	207	120	30-1/8 [765]	14 [356]	19 [483]	14 [356]	19 [483]	14 [356]	14 [356]
PHJ330	207	120	30-1/8 [765]	14 [356]	19 [483]	14 [356]	19 [483]	14 [356]	14 [356]
PHJ336	207	120	34-1/8 [867]	14 [356]	19 [483]	16 [408]	19 [483]	16 [408]	16 [408]

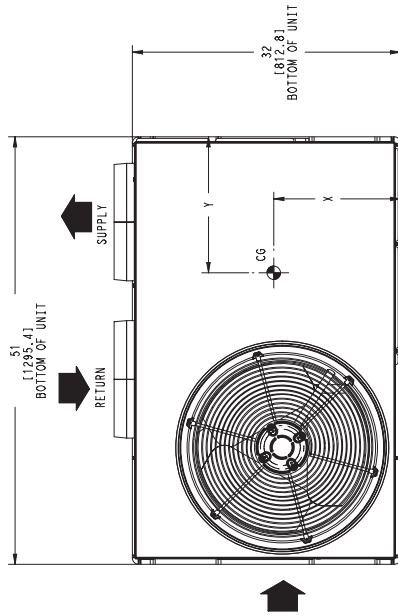

TOP VIEW

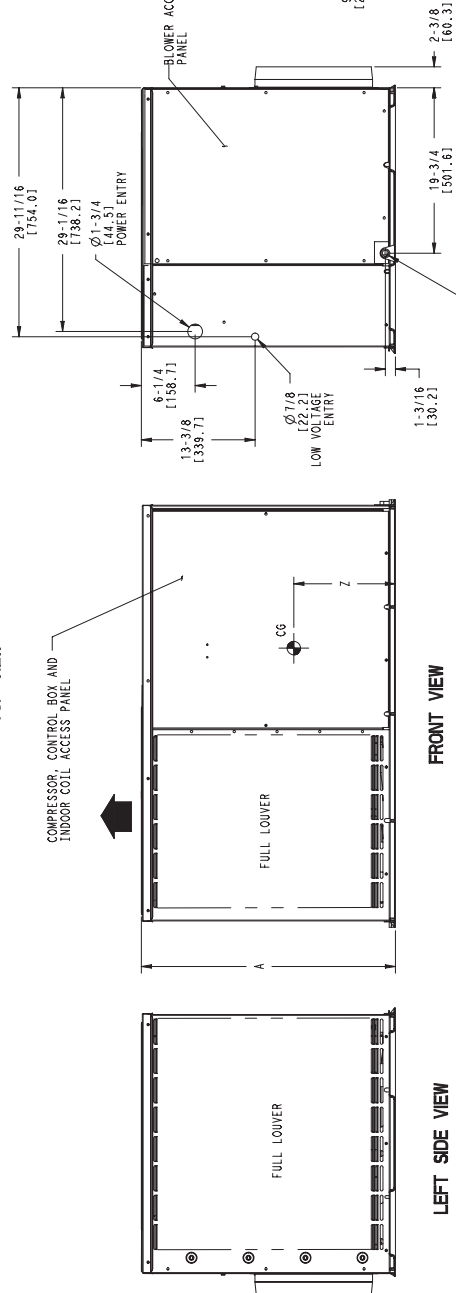

FRONT VIEW

LEFT SIDE VIEW

RIGHT SIDE VIEW

REAR VIEW

**REQUIRED CLEARANCES TO COMBUSTIBLE MATL.**

TOP OF UNIT.....	INCHES [MM]
SIDE OF UNIT.....	0
SIDE OF UNIT WITH DUCT OPENINGS.....	0
SIDE OF UNIT OPPOSITE DUCT OPENINGS.....	0

**NEC REQUIRED CLEARANCES**

BETWEEN UNITS, POWER ENTRY SIDE.....	INCHES [MM]
UNIT AND UNGROUNDED SURFACES, POWER ENTRY SIDE.....	42.0 [1067]
UNIT AND BLOCK OR CONCRETE WALLS AND OTHER GROUNDED SURFACES, POWER ENTRY SIDE.....	36.0 [914]
UNIT AND BLOCK OR CONCRETE WALLS AND OTHER GROUNDED SURFACES, POWER ENTRY SIDE.....	42.0 [1067]

**REQUIRED CLEARANCE FOR SERVICING**

TOP OF UNIT, OPPOSITE DUCT OPENINGS.....	INCHES [MM]
SIDE OF UNIT WITH POWER ENTRY.....	36.0 [914]
TOP OF UNIT, OPPOSITE DUCT OPENINGS.....	36.0 [914]
SIDE OF UNIT WITH POWER ENTRY.....	30.0 [762]
TOP OF UNIT, OPPOSITE DUCT OPENINGS.....	30.0 [762]

NOTE: CLEARANCES MUST BE MAINTAINED TO PREVENT REGULATION OF AIR FROM UNIT AND CONDENSATE DISCHARGE. A REMOVABLE FENCE OR BARRICADE REQUIRES NO CLEARANCE.

DIMENSIONS IN [ ] ARE IN MM

# UNIT DIMENSIONS – PHJ342–60

UNIT	ELECTRICAL CHARACTERISTICS		UNIT WT.			UNIT HEIGHT			CENTER OF GRAVITY IN [MM]		
	LG.	MG.	A	X	Y	Z	A	X	Y	Z	
PHJ342	339	154	42-1/8 [1070]	14 [356]	19 [483]	19-3/4 [503]					
PHJ348	358	163	42-1/8 [1070]	14 [356]	19 [483]	19-3/4 [503]					
PHJ360	371	169	42-1/8 [1070]	14 [356]	19 [483]	19-3/4 [503]					

**REQUIRED CLEARANCES TO COMBUSTIBLE MATL.**

TOP OF UNIT..... INCHES [MM] .....0  
 BOTTOM OF UNIT WITH DUCT OPENINGS.....0  
 SIDE OF UNIT OPPOSITE DUCT OPENINGS.....0

**MEC. REQUIRED CLEARANCES**

BETWEEN UNITS, POWER ENTRY SIDE..... INCHES [MM] .....0  
 UNIT AND UNGROUNDED SURFACES, POWER ENTRY SIDE.....36.0 [914]  
 UNIT AND BLOCK OR CONCRETE WALLS AND OTHER GROUNDED SURFACES, POWER ENTRY SIDE.....42.0 [1067]

**REQUIRED CLEARANCE FOR SERVICING**

TOP OF UNIT..... INCHES [MM] .....36.0 [914]  
 SIDE OF UNIT OPPOSITE DUCT OPENINGS.....30.0 [762]  
 SIDE OF UNIT WITH DUCT OPENINGS.....30.0 [762]  
 (EXCEPT FOR NEC REQUIREMENTS)

NOTE: CLEARANCES MUST BE MAINTAINED TO PREVENT RECIRCULATION OF AIR FROM OUTDOOR FAN DISCHARGE. A REMOVABLE FENCE OR BARRICADE REQUIRES NO CLEARANCE.

DIMENSIONS IN [ ] ARE IN MM

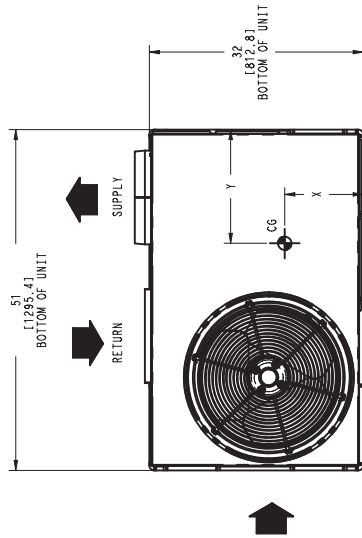

TOP VIEW

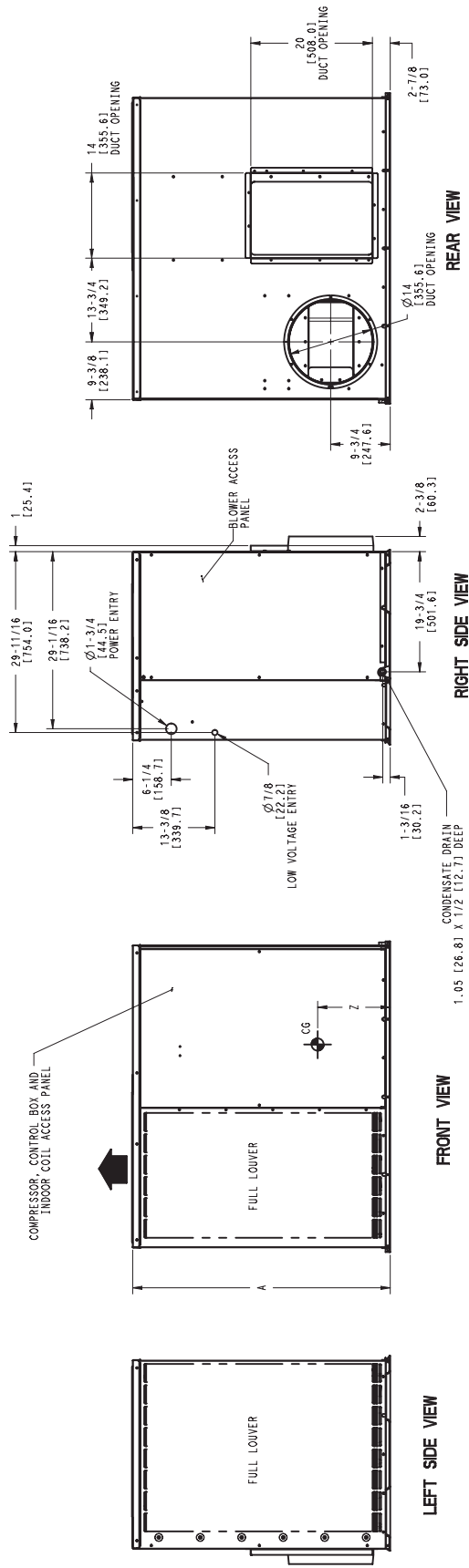

REV	50ZH500473
	-

# SELECTION PROCEDURE

## I. DETERMINE COOLING AND HEATING REQUIREMENTS AT DESIGN CONDITIONS

Given:

- Required Cooling Capacity (TC) ..... 28,000 Btuh
- Sensible Heat Capacity (SHC) ..... 20,500 Btuh
- Required Heating Capacity ..... 28,550 Btuh
- Outdoor Entering–Air Temperature ..... 95°F (35°C)
- Outdoor–Air Winter Design Temperature 20°F (–6.7°C)
- Indoor–Air Winter Design Temperature ..... 70°F (21.1°C)
- Indoor Entering–Air Temperature ..... 80°F (26.7°C)  
edb, 67°F ewb (19.4°C)
- Indoor–Air Quantity ..... 1000 CFM
- External Static Pressure ..... 0.20 IN. W.C.
- Electrical Characteristics (V–Ph–Hz) ..... 230–1–60  
edb — entering dry bulb  
ewb — entering wet bulb

## II. SELECT UNIT BASED ON REQUIRED COOLING CAPACITY

Enter Cooling Capacities table at condenser entering temperature of 95°F (35°C), indoor air entering at 1000 cfm and 67°F (19.4°C) ewb (entering wet bulb). The 50ZHB030 unit will provide a total cooling capacity of 28,800 Btuh and a sensible heat capacity of 21,600 Btuh.

For indoor–air temperature other than 80°F edb (entering dry bulb), calculate sensible heat capacity correction, as required, using the formula found in Note 3 following the cooling capacities tables.

NOTE: Unit ratings are net capacities.

## III. SELECT ELECTRIC HEAT

Enter the 50ZHB030 Heating Capacities table at 1000 CFM. At 70°F (21.1°C) return indoor air and 20°F (–6.7°C) air entering outdoor coil, the integrated heating capacity is 16,740 Btuh. (Select integrated heating capacity value since deductions for outdoor–coil frost and defrosting have already been made. No correction is required.)

The required heating capacity is 28,550 Btuh. Therefore, 11,810 Btuh (28,550 – 16,740) additional electric heat is required.

Determine additional electric heat capacity in kW.

$$\frac{11,810 \text{ Btuh}}{3414 \text{ Btuh/kW}} = 3.46 \text{ kW of heat required}$$

Enter the Accessory Electric Heater Usage table on page 4 for 208/240v. single–phase, 50ZHB030 unit. The 5–kW heater at 240v most closely satisfies the heating required. To calculate kW at 230v, multiply the heater kW by multiplication factor 0.92 found in the Multiplication Factors table on page 5.

$$5 \text{ kW} \times 0.92 = 4.6 \text{ kW}$$

$$4.6 \times 3414 = 15,704 \text{ Btuh}$$

To calculate kW at 208 v, see Multiplication Factors table on page 5.

Total unit heating capacity is 32,444 Btuh (16,740 +15,704).

## IV. DETERMINE FAN SPEED AND POWER REQUIREMENTS AT DESIGN CONDITIONS

Before entering the air delivery tables, calculate the total static pressure required. From the given, the Accessory Electric Heat Pressure Drop table, and the Filter Pressure Drop table, find:

External static pressure	0.20 IN. W.C.
Filter	0.09 IN. W.C.
Electric heat	0.04 IN. W.C.
Total static pressure	0.33 IN. W.C.

Enter the table for Dry Coil Air Delivery — Horizontal Discharge at 1000 CFM and 230v high speed. The blower will deliver 1036 CFM @ 0.40 IN W.C. static pressure. This will adequately handle job requirements.



# BALANCE POINT WORKSHEET

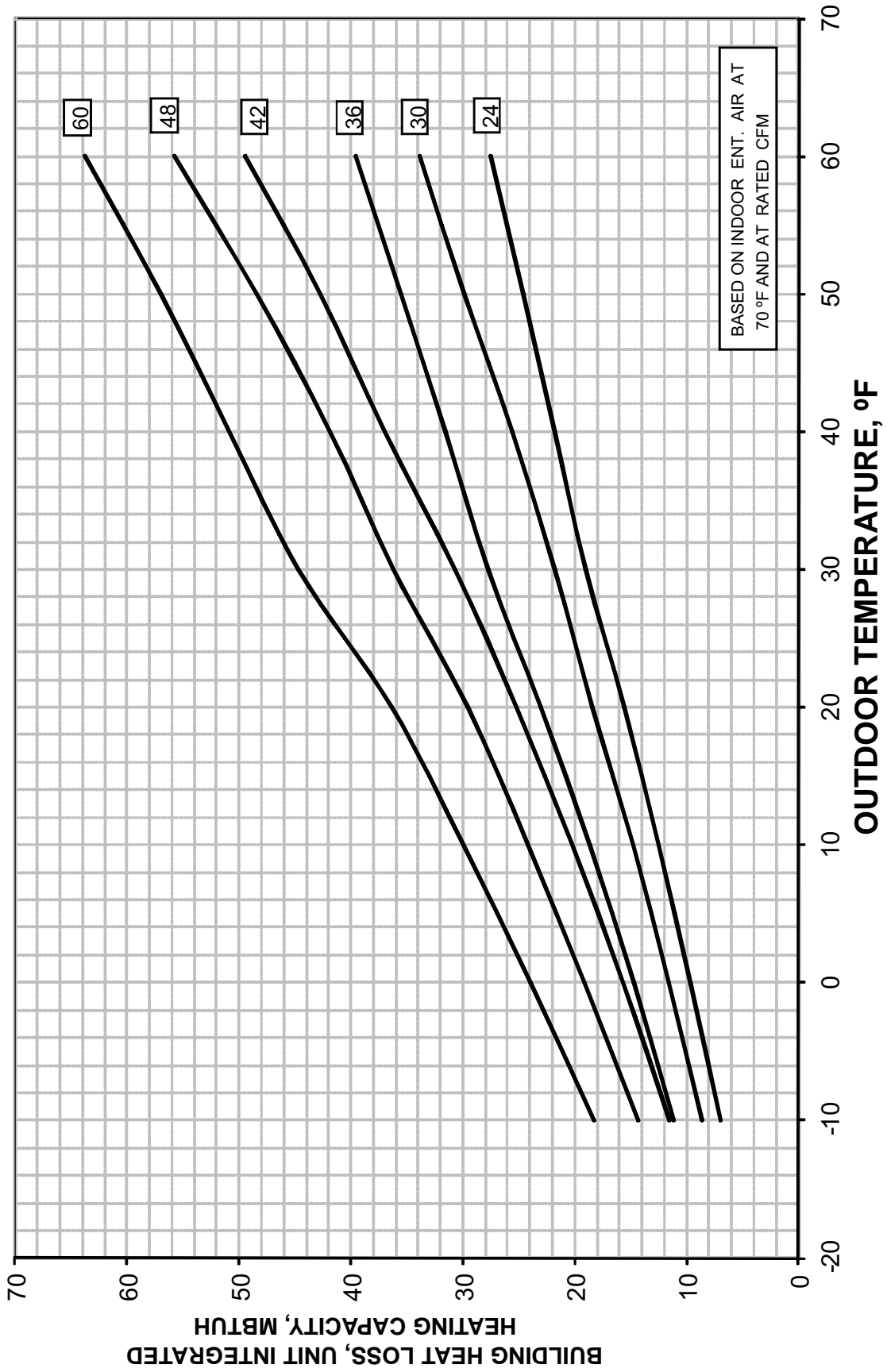

# PERFORMANCE DATA

## Cooling Capacities

### PHJ324

EVAPORATOR AIR		CONDENSER ENTERING AIR TEMPERATURES °F (°C)																			
		75 (24)			85 (29)			95 (35)			105 (41)			115 (46)			125 (52)				
		Return Air db °F (°C)	CFM	EWB °F (°C)	Capacity MBtuh		Total Sys KW	Capacity MBtuh		Total Sys KW	Capacity MBtuh		Total Sys KW	Capacity MBtuh		Total Sys KW	Capacity MBtuh		Total Sys KW		
Total	Sens				Total	Sens		Total	Sens		Total	Sens		Total	Sens						
700 / 0.08	700	700	57 (14)	22.96	22.96	1.61	22.41	22.41	1.82	21.85	21.85	2.05	20.67	20.67	2.30	19.14	19.14	2.58	17.50	17.50	2.90
	800	800	62 (17)	23.69	23.69	1.61	21.68	21.68	1.82	21.56	21.56	2.06	20.80	21.27	2.30	19.18	19.18	2.58	17.53	17.53	2.90
	900	900	63* (17)	24.01	23.29	1.62	17.85	17.48	1.83	22.50	17.48	2.06	21.20	17.16	2.30	19.18	19.18	2.58	16.93	16.93	2.89
	700	700	67 (19)	25.13	17.88	1.62	17.79	17.60	1.84	23.72	17.60	2.07	22.89	17.60	2.33	21.31	17.22	2.61	19.11	16.34	2.91
	800	800	72 (22)	26.32	14.26	1.63	14.21	13.86	1.85	25.12	13.86	2.09	24.29	13.62	2.35	23.47	13.52	2.64	21.77	13.02	2.96
800 / 0.10	700	700	57 (14)	23.63	23.63	1.63	23.07	23.07	1.84	22.46	22.46	2.07	21.68	21.68	2.33	20.19	20.19	2.61	18.49	18.49	2.92
	800	800	62 (17)	24.06	22.94	1.63	22.84	22.84	1.84	22.60	22.82	2.07	21.71	21.71	2.33	20.22	20.22	2.61	18.53	18.53	2.92
	900	900	63 (17)	24.35	18.61	1.63	18.46	18.37	1.84	22.84	18.37	2.08	21.72	18.34	2.33	19.71	17.50	2.60	17.41	16.44	2.91
	700	700	67 (19)	25.41	18.51	1.64	18.54	18.38	1.86	24.00	18.38	2.09	23.13	18.35	2.35	21.77	18.42	2.63	19.57	17.63	2.93
	800	800	72 (22)	26.54	14.57	1.65	14.57	14.26	1.87	25.38	14.26	2.10	24.52	14.04	2.36	23.60	13.86	2.66	22.15	13.70	2.98
900 / 0.11	700	700	57 (14)	24.11	24.11	1.64	23.60	23.60	1.86	22.95	22.95	2.09	22.34	22.34	2.35	21.00	21.00	2.63	19.26	19.26	2.94
	800	800	62 (17)	24.35	23.89	1.65	23.70	23.84	1.86	22.36	22.36	2.09	22.37	22.37	2.35	21.03	21.03	2.63	19.29	19.29	2.95
	900	900	63 (17)	24.59	19.25	1.65	19.21	19.15	1.86	23.08	19.15	2.09	22.09	19.38	2.34	20.12	18.68	2.62	17.82	17.82	2.93
	700	700	67 (19)	25.62	19.06	1.66	19.22	18.7	1.87	24.22	19.09	2.10	23.35	19.14	2.36	22.12	19.49	2.65	19.95	18.82	2.96
	800	800	72 (22)	26.70	14.83	1.66	14.85	14.60	1.89	25.57	14.60	2.12	24.68	14.39	2.38	23.72	14.27	2.67	22.41	14.30	3.00

# Heating Capacities

### PHJ324

INDOOR AIR		OUTDOOR COIL ENTERING AIR TEMPERATURES °F (°C)																							
		-10 (-23)			0 (-18)			10 (-12)			20 (-7)			30 (-1)			40 (4)			50 (10)			60 (16)		
		Return Air db °F (°C)	CFM	Capacity MBtuh	Total Sys KW	Capacity MBtuh	Total Sys KW	Capacity MBtuh	Total Sys KW	Capacity MBtuh	Total Sys KW	Capacity MBtuh	Total Sys KW	Capacity MBtuh	Total Sys KW	Capacity MBtuh	Total Sys KW	Capacity MBtuh	Total Sys KW	Capacity MBtuh	Total Sys KW	Capacity MBtuh	Total Sys KW		
Total	Integ																							Total	Integ
65 (18)	700	728	6.69	1.47	9.93	9.14	1.58	12.73	11.69	1.65	15.77	14.31	1.71	19.17	16.80	1.76	22.00	22.00	1.80	24.93	24.93	1.86	28.00	28.00	1.93
	800	738	6.79	1.47	10.06	9.26	1.57	12.89	11.83	1.64	16.00	14.51	1.69	19.24	16.86	1.73	22.03	22.03	1.76	24.89	24.89	1.80	27.83	27.83	1.86
	900	747	6.88	1.48	10.19	9.37	1.57	13.05	11.98	1.63	16.17	14.67	1.67	19.28	16.90	1.70	22.02	22.02	1.73	24.80	24.80	1.76	27.58	27.58	1.80
70 (21)	700	6.86	6.31	1.54	9.53	8.77	1.65	12.35	11.33	1.73	15.38	13.95	1.79	18.97	16.62	1.85	21.76	21.76	1.90	24.66	24.66	1.96	27.67	27.67	2.03
	800	6.97	6.42	1.54	9.68	8.91	1.65	12.52	11.49	1.72	15.59	14.14	1.77	19.05	16.69	1.82	21.81	21.81	1.85	24.65	24.65	1.90	27.55	27.55	1.96
	900	7.08	6.51	1.55	9.80	9.02	1.65	12.67	11.63	1.71	15.77	14.30	1.76	19.10	16.73	1.79	21.82	21.82	1.82	24.59	24.59	1.86	27.34	27.34	1.90
75 (24)	700	6.38	5.87	1.61	9.11	8.38	1.73	11.94	10.96	1.81	14.96	13.57	1.88	18.68	16.37	1.96	21.53	21.53	2.00	24.41	24.41	2.06	27.35	27.35	2.14
	800	6.50	5.98	1.61	9.25	8.51	1.73	12.11	11.12	1.80	15.18	13.76	1.86	18.85	16.51	1.92	21.58	21.58	1.95	24.41	24.41	2.00	27.27	27.27	2.06
	900	6.62	6.09	1.62	9.38	8.63	1.72	12.26	11.25	1.79	15.35	13.92	1.84	18.92	16.57	1.89	21.60	21.60	1.92	24.34	24.34	1.96	27.07	27.07	2.01

See Legend and Notes on page 16.

# PERFORMANCE DATA (CONT.)

## Cooling Capacities

### PHJ330

EVAPORATOR AIR		CONDENSER ENTERING AIR TEMPERATURES °F (°C)																	
		75 (24)			85 (29)			95 (35)			105 (41)			115 (46)			125 (52)		
		Capacity MBtuh		Total Sys kW	Capacity MBtuh		Total Sys kW	Capacity MBtuh		Total Sys kW	Capacity MBtuh		Total Sys kW	Capacity MBtuh		Total Sys kW	Capacity MBtuh		Total Sys kW
CFM / BF	EWB °F (°C)	Total	Sens	Total	Sens	Total	Sens	Total	Sens	Total	Sens	Total	Sens	Total	Sens	Total	Sens	Total	Sens
875 / 0.08	57 (14)	27.82	27.30	27.30	2.20	26.53	26.53	2.45	25.50	25.50	2.75	24.19	24.19	3.08	22.57	22.57	3.47		
	62 (17)	28.38	27.75	25.67	2.20	26.84	25.54	2.46	25.63	25.09	2.75	24.24	24.24	3.08	22.60	22.60	3.47		
	63 (17)	28.69	28.06	20.76	2.21	27.16	20.58	2.46	25.94	20.16	2.75	24.37	19.46	3.08	22.28	18.53	3.45		
	67 (19)	29.82	29.31	20.71	2.22	28.51	20.67	2.48	27.39	20.44	2.77	26.01	20.06	3.10	24.38	19.55	3.48		
	72 (22)	31.10	30.75	16.22	2.24	30.03	16.06	2.50	29.06	15.79	2.80	27.80	15.42	3.13	26.20	14.93	3.51		
1000 / 0.09	57 (14)	28.43	27.96	27.96	2.23	27.26	27.26	2.49	26.29	26.29	2.78	25.07	25.07	3.11	23.66	23.66	3.49		
	62 (17)	28.74	28.15	27.00	2.23	27.28	27.28	2.49	26.31	26.31	2.78	25.10	25.10	3.11	23.69	23.69	3.49		
	63 (17)	28.99	28.39	21.71	2.23	27.51	21.66	2.49	26.30	21.37	2.78	24.79	20.84	3.11	22.73	19.92	3.49		
	67 (19)	30.09	29.60	21.54	2.24	28.80	21.60	2.50	27.69	21.48	2.80	26.31	21.22	3.13	24.66	20.78	3.51		
	72 (22)	31.31	30.99	16.61	2.26	30.28	16.51	2.52	29.32	16.30	2.82	28.04	15.98	3.16	26.45	15.54	3.54		
1125 / 0.10	57 (14)	28.85	28.44	28.44	2.25	27.77	27.77	2.51	26.82	26.82	2.81	25.64	25.64	3.14	24.25	24.25	3.52		
	62 (17)	29.02	28.45	28.45	2.25	27.79	27.79	2.51	26.84	26.84	2.81	25.66	25.66	3.14	24.27	24.27	3.52		
	63 (17)	29.21	28.63	22.55	2.26	27.76	22.62	2.51	26.56	22.44	2.80	25.09	22.04	3.13	23.18	21.25	3.51		
	67 (19)	30.29	29.82	22.26	2.27	29.01	22.42	2.53	27.91	22.42	2.82	26.53	22.26	3.16	24.87	21.88	3.53		
	72 (22)	31.49	31.16	16.94	2.28	30.46	16.89	2.55	29.51	16.74	2.84	28.22	16.46	3.18	26.63	16.08	3.56		

# Heating Capacities

## PHJ330

INDOOR AIR		OUTDOOR COIL ENTERING AIR TEMPERATURES °F (°C)																							
		-10 (-23)			0 (-18)			10 (-12)			20 (-7)			30 (-1)			40 (4)			50 (10)			60 (16)		
		Capacity MBtuh		Total Sys kW	Capacity MBtuh		Total Sys kW	Capacity MBtuh		Total Sys kW	Capacity MBtuh		Total Sys kW	Capacity MBtuh		Total Sys kW	Capacity MBtuh		Total Sys kW	Capacity MBtuh		Total Sys kW			
Return Air db °F (°C)	CFM	Total	Integ	Total	Integ	Total	Integ	Total	Integ	Total	Integ	Total	Integ	Total	Integ	Total	Integ	Total	Integ	Total	Integ				
65 (18)	875	8.92	8.21	1.74	11.84	10.90	1.81	15.00	13.77	1.88	18.52	16.80	1.96	21.87	19.17	2.03	25.66	25.66	2.12	29.97	29.97	2.24	34.48	34.48	
	1000	9.05	8.32	1.74	11.99	11.03	1.81	15.17	13.93	1.87	18.67	16.93	1.94	22.07	19.34	2.01	25.91	25.91	2.09	30.27	30.27	2.18	34.10	34.10	
	1125	9.16	8.43	1.75	12.12	11.15	1.81	15.34	14.08	1.87	18.80	17.05	1.93	22.24	19.48	1.99	26.12	26.12	2.07	30.15	30.15	2.14	33.52	33.52	
70 (21)	875	8.51	7.83	1.82	11.47	10.55	1.90	14.63	13.42	1.97	18.30	16.60	2.06	21.60	18.93	2.14	25.33	25.33	2.23	29.56	29.56	2.30	34.13	34.13	
	1000	8.65	7.96	1.83	11.63	10.70	1.89	14.81	13.59	1.96	18.45	16.74	2.04	21.80	19.10	2.11	25.59	25.59	2.19	29.89	29.89	2.30	33.85	33.85	
	1125	8.77	8.07	1.84	11.77	10.83	1.90	14.97	13.74	1.96	18.58	16.85	2.03	21.97	19.25	2.09	25.80	25.80	2.17	29.95	29.95	2.25	33.38	33.38	
75 (24)	875	8.05	7.41	1.90	11.06	10.17	1.99	14.23	13.06	2.07	18.03	16.35	2.17	21.33	18.69	2.25	25.00	25.00	2.34	29.16	29.16	2.46	33.79	33.79	
	1000	8.19	7.54	1.91	11.22	10.32	1.99	14.41	13.23	2.06	18.20	16.51	2.15	21.52	18.86	2.22	25.25	25.25	2.30	29.48	29.48	2.41	33.58	33.58	
	1125	8.31	7.65	1.92	11.36	10.45	1.99	14.57	13.38	2.05	18.35	16.64	2.14	21.69	19.00	2.20	25.47	25.47	2.28	29.68	29.68	2.36	33.18	33.18	

See Legend and Notes on page 16.

# PERFORMANCE DATA (CONT.)

## Cooling Capacities

### PHJ336

EVAPORATOR AIR		CONDENSER ENTERING AIR TEMPERATURES °F (°C)																	
		75 (24)			85 (29)			95 (35)			105 (41)			115 (46)			125 (52)		
		Capacity MBtuh		Total Sys kW	Capacity MBtuh		Total Sys kW	Capacity MBtuh		Total Sys kW	Capacity MBtuh		Total Sys kW	Capacity MBtuh		Total Sys kW	Capacity MBtuh		Total Sys kW
CFM / BF	EWB °F (°C)	Total	Sens	Total	Sens	Total	Sens	Total	Sens	Total	Sens	Total	Sens	Total	Sens	Total	Sens	Total	
1050 / 0.07	57 (14)	34.80	34.80	2.48	33.68	2.76	32.36	3.07	30.96	3.42	29.36	3.81	27.11	4.25	27.11	4.25	27.11	4.25	
	62 (17)	35.83	32.61	2.49	34.48	2.77	32.91	3.10	31.22	3.42	29.40	3.81	27.15	4.25	27.15	4.25	27.15	4.25	
	63 (17)	36.36	26.67	2.50	34.99	2.77	33.37	3.08	31.59	3.42	29.44	3.81	26.40	4.24	26.40	4.24	26.40	4.24	
1200 / 0.08	67 (19)	38.38	26.96	2.51	37.11	2.79	35.50	3.10	33.63	3.45	31.66	3.84	29.23	4.28	29.23	4.28	29.23	4.28	
	72 (22)	40.73	21.67	2.53	39.62	2.81	38.08	3.12	36.22	3.48	34.03	3.87	31.85	4.33	31.85	4.33	31.85	4.33	
	57 (14)	35.86	35.86	2.52	34.74	2.80	33.39	3.11	31.88	3.46	30.41	3.85	28.30	4.30	28.30	4.30	28.30	4.30	
1350 / 0.10	62 (17)	36.46	34.39	2.52	35.13	2.80	33.57	3.11	31.90	3.46	30.44	3.85	28.33	4.30	28.33	4.30	28.33	4.30	
	63 (17)	36.90	27.87	2.53	35.55	2.80	33.90	3.11	32.04	3.46	30.02	3.85	27.04	4.28	27.04	4.28	27.04	4.28	
	67 (19)	38.89	28.05	2.54	37.62	2.82	36.00	3.13	34.09	3.48	32.05	3.88	29.71	4.32	29.71	4.32	29.71	4.32	
1350 / 0.10	72 (22)	41.16	22.23	2.56	40.07	2.84	38.52	3.16	36.64	3.51	34.40	3.91	32.17	4.36	32.17	4.36	32.17	4.36	
	57 (14)	36.64	36.64	2.55	35.54	2.83	34.17	3.14	32.57	3.49	30.97	3.89	29.13	4.34	29.13	4.34	29.13	4.34	
	62 (17)	36.96	35.90	2.55	35.68	2.83	34.18	3.14	32.60	3.49	31.00	3.89	29.16	4.34	29.16	4.34	29.16	4.34	
1350 / 0.10	63 (17)	37.33	28.93	2.56	35.96	2.83	34.29	3.14	32.38	3.49	30.42	3.88	27.54	4.31	27.54	4.31	27.54	4.31	
	67 (19)	39.26	29.02	2.57	38.01	2.85	36.36	3.16	34.43	3.51	32.34	3.91	30.07	4.36	30.07	4.36	30.07	4.36	
	72 (22)	41.47	22.69	2.59	40.40	2.87	38.85	3.19	36.95	3.54	34.68	3.94	32.39	4.39	32.39	4.39	32.39	4.39	

# Heating Capacities

## PHJ336

INDOOR AIR		OUTDOOR COIL ENTERING AIR TEMPERATURES °F (°C)																							
		-10 (-23)			0 (-18)			10 (-12)			20 (-7)			30 (-1)			40 (4)			50 (10)			60 (16)		
		Capacity MBtuh		Total Sys kW	Capacity MBtuh		Total Sys kW	Capacity MBtuh		Total Sys kW	Capacity MBtuh		Total Sys kW	Capacity MBtuh		Total Sys kW	Capacity MBtuh		Total Sys kW	Capacity MBtuh		Total Sys kW	Capacity MBtuh		Total Sys kW
Return Air db °F (°C)	CFM	Total	Integ	Total	Integ	Total	Integ	Total	Integ	Total	Integ	Total	Integ	Total	Integ	Total	Integ	Total	Integ	Total	Integ	Total	Integ		
65 (18)	1050	11.54	10.62	2.30	15.05	13.85	2.39	18.95	17.39	2.49	23.38	21.20	2.60	27.98	24.52	2.70	31.92	31.92	2.79	36.05	36.05	2.88	40.34	40.34	
	1200	11.73	10.79	2.31	15.27	14.05	2.39	19.21	17.63	2.48	23.78	21.56	2.58	28.06	24.59	2.66	31.92	31.92	2.74	35.94	35.94	2.82	40.00	40.00	
	1350	11.90	10.95	2.32	15.46	14.23	2.40	19.42	17.83	2.48	24.29	22.03	2.59	28.07	24.59	2.64	31.86	31.86	2.71	35.73	35.73	2.78	39.47	39.47	
70 (21)	1050	10.95	10.08	2.41	14.50	13.34	2.51	18.42	16.90	2.61	22.76	20.64	2.71	27.71	24.28	2.83	31.59	31.59	2.92	35.66	35.66	3.02	39.91	39.91	
	1200	11.15	10.25	2.42	14.72	13.55	2.51	18.67	17.14	2.60	23.07	20.92	2.69	27.78	24.34	2.79	31.61	31.61	2.87	35.59	35.59	2.96	39.62	39.62	
	1350	11.31	10.41	2.44	14.91	13.72	2.52	18.89	17.34	2.60	23.35	21.17	2.69	27.83	24.38	2.77	31.57	31.57	2.84	35.43	35.43	2.91	39.19	39.19	
75 (24)	1050	10.32	9.49	2.54	13.90	12.79	2.63	17.85	16.38	2.73	22.18	20.12	2.84	27.45	24.05	2.98	31.26	31.26	3.07	35.27	35.27	3.17	39.45	39.45	
	1200	10.51	9.67	2.55	14.12	13.00	2.63	18.11	16.62	2.73	22.49	20.40	2.82	27.54	24.13	2.94	31.29	31.29	3.01	35.23	35.23	3.10	39.24	39.24	
	1350	10.67	9.82	2.56	14.31	13.17	2.64	18.33	16.82	2.72	22.75	20.63	2.81	27.60	24.18	2.91	31.28	31.28	2.98	35.11	35.11	3.06	38.87	38.87	

See Legend and Notes on page 16.

# PERFORMANCE DATA (CONT.)

## Cooling Capacities

### PHJ342

EVAPORATOR AIR		CONDENSER ENTERING AIR TEMPERATURES °F (°C)																	
		75 (24)			85 (29)			95 (35)			105 (41)			115 (46)			125 (52)		
		CFM / BF	EWB °F (°C)	Capacity MBtuh		Total Sys kW	Capacity MBtuh		Total Sys kW	Capacity MBtuh		Total Sys kW	Capacity MBtuh		Total Sys kW	Capacity MBtuh		Total Sys kW	
Total	Sens			Total	Sens		Total	Sens		Total	Sens		Total	Sens					
1225 / 0.11	57 (14)	39.44	39.44	2.86	37.89	37.89	3.16	35.26	35.26	3.49	32.83	32.83	3.86	30.29	30.29	4.29	27.53	27.53	4.77
	62 (17)	40.83	36.35	2.87	38.87	35.37	3.17	35.71	33.63	3.49	32.88	32.88	3.86	30.33	30.33	4.29	27.57	27.57	4.77
	63* (17)	41.77	29.61	2.87	39.75	28.75	3.18	36.73	27.48	3.50	33.21	26.03	3.87	29.73	24.59	4.28	25.94	22.96	4.74
	67 (19)	45.20	30.87	2.90	43.07	30.03	3.21	40.81	29.14	3.56	37.31	27.80	3.92	33.36	26.29	4.33	29.48	24.79	4.80
	72 (22)	50.06	25.07	2.95	47.76	24.23	3.26	45.31	23.37	3.61	42.72	22.45	4.01	39.72	21.41	4.44	34.69	19.71	4.89
1400 / 0.12	57 (14)	40.99	40.99	2.91	39.36	39.36	3.22	37.54	37.54	3.56	34.31	34.31	3.92	31.63	31.63	4.35	28.76	28.76	4.83
	62 (17)	41.70	38.58	2.91	39.63	39.63	3.22	37.60	37.60	3.56	34.36	34.36	3.92	31.67	31.67	4.35	28.79	28.79	4.83
	63 (17)	42.59	31.37	2.92	40.50	30.50	3.23	38.19	29.53	3.57	33.90	27.77	3.92	30.31	26.24	4.33	26.48	24.45	4.79
	67 (19)	46.07	32.76	2.95	43.87	31.91	3.26	41.50	31.00	3.61	38.85	29.98	3.99	34.05	28.14	4.38	30.05	26.52	4.85
	72 (22)	51.04	26.26	3.00	48.65	25.41	3.32	46.10	24.53	3.67	43.42	23.60	4.06	40.39	22.57	4.50	35.44	20.92	4.95
1575 / 0.14	57 (14)	42.35	42.35	2.96	40.65	40.65	3.27	38.82	38.82	3.62	35.74	35.74	3.98	32.82	32.82	4.41	29.82	29.82	4.89
	62 (17)	42.53	42.53	2.96	40.70	40.70	3.27	38.86	38.86	3.62	35.78	35.78	3.98	32.86	32.86	4.41	29.85	29.85	4.89
	63 (17)	43.27	33.10	2.97	41.11	32.21	3.27	38.76	31.24	3.62	34.51	29.44	3.96	30.83	27.78	4.38	26.99	26.99	4.84
	67 (19)	46.80	34.63	3.00	44.50	33.75	3.31	42.09	32.83	3.66	39.37	31.78	4.04	34.65	29.90	4.44	30.55	28.07	4.90
	72 (22)	51.83	27.42	3.05	49.36	26.56	3.36	46.75	25.67	3.72	43.98	24.73	4.11	40.93	23.70	4.55	36.05	22.10	5.00

# Heating Capacities

## PHJ342

INDOOR AIR		OUTDOOR COIL ENTERING AIR TEMPERATURES °F (°C)																							
		-10 (-23)			0 (-18)			10 (-12)			20 (-7)			30 (-1)			40 (4)			50 (10)			60 (16)		
		Return Air db °F (°C)	CFM	Capacity MBtuh		Total Sys kW	Capacity MBtuh		Total Sys kW	Capacity MBtuh		Total Sys kW	Capacity MBtuh		Total Sys kW	Capacity MBtuh		Total Sys kW	Capacity MBtuh		Total Sys kW	Capacity MBtuh		Total Sys kW	
Total	Integ			Total	Integ		Total	Integ		Total	Integ		Total	Integ		Total	Integ		Total	Integ		Total	Integ		Total
65 (18)	1225	12.14	11.17	2.54	16.20	14.90	2.65	20.68	18.98	2.77	25.59	23.21	2.90	31.13	27.28	3.05	37.09	37.09	3.24	42.85	42.85	3.42	49.49	49.49	3.66
	1400	12.39	11.40	2.56	16.49	15.17	2.66	21.02	19.29	2.78	25.98	23.56	2.89	31.77	27.84	3.04	37.47	37.47	3.20	43.38	43.38	3.37	50.17	50.17	3.58
	1575	12.62	11.61	2.58	16.72	15.38	2.68	21.29	19.54	2.78	26.30	23.86	2.89	32.51	28.49	3.04	37.84	37.84	3.17	43.84	43.84	3.33	50.78	50.78	3.53
70 (21)	1225	11.34	10.44	2.65	15.44	14.20	2.77	19.93	18.30	2.90	24.86	22.54	3.03	30.27	26.52	3.18	36.59	36.59	3.40	42.22	42.22	3.58	48.72	48.72	3.83
	1400	11.56	10.63	2.67	15.69	14.43	2.79	20.24	18.58	2.90	25.22	22.87	3.02	30.70	26.90	3.16	36.98	36.98	3.36	42.72	42.72	3.52	49.41	49.41	3.75
	1575	11.77	10.83	2.70	15.95	14.67	2.80	20.54	18.85	2.91	25.57	23.19	3.02	31.12	27.27	3.15	37.32	37.32	3.33	43.18	43.18	3.48	49.98	49.98	3.69
75 (24)	1225	10.50	9.66	2.78	14.61	13.45	2.90	19.14	17.57	3.03	24.09	21.85	3.17	29.48	25.83	3.32	36.02	36.02	3.56	41.59	41.59	3.76	47.96	47.96	4.00
	1400	10.74	9.88	2.80	14.89	13.70	2.92	19.48	17.88	3.03	24.48	22.20	3.16	29.93	26.23	3.30	36.44	36.44	3.52	42.07	42.07	3.70	48.62	48.62	3.92
	1575	10.95	10.08	2.83	15.16	13.95	2.93	19.78	18.16	3.04	24.81	22.50	3.16	30.33	26.57	3.29	36.81	36.81	3.49	42.52	42.52	3.65	49.20	49.20	3.87

See Legend and Notes on page 16.

# PERFORMANCE DATA (CONT.)

## Cooling Capacities

### PHJ348

EVAPORATOR AIR		CONDENSER ENTERING AIR TEMPERATURES °F (°C)																	
		75 (24)			85 (29)			95 (35)			105 (41)			115 (46)			125 (52)		
		Capacity MBtuh		Total Sys kW	Capacity MBtuh		Total Sys kW	Capacity MBtuh		Total Sys kW	Capacity MBtuh		Total Sys kW	Capacity MBtuh		Total Sys kW	Capacity MBtuh		Total Sys kW
CFM / BF	EWB °F (°C)	Total	Sens	Total	Sens	Total	Sens	Total	Sens	Total	Sens	Total	Sens	Total	Sens	Total	Sens	Total	Sens
		1400 / 0.07	57 (14)	45.20	45.20	43.33	3.55	41.34	41.34	3.95	38.12	38.12	4.35	35.13	35.13	4.81	32.15	32.15	5.34
62 (17)	46.71		41.68	40.56	3.56	39.40	39.40	3.95	38.15	38.15	4.35	35.19	35.19	4.81	32.20	32.20	5.34		
63 (17)	47.53		34.01	32.92	3.56	31.77	31.77	3.96	38.58	29.94	4.36	34.57	28.26	4.80	30.67	26.63	5.30		
1600 / 0.08	57 (14)	50.96	35.23	34.13	3.59	45.76	33.06	3.99	42.98	31.99	4.43	38.86	30.18	4.90	34.57	28.52	5.40		
	62 (17)	55.43	28.68	27.63	3.62	49.88	26.55	4.04	46.91	25.38	4.49	43.79	24.21	4.97	39.86	22.94	5.50		
	67 (14)	47.06	47.06	45.06	3.62	45.06	42.96	4.01	40.20	40.20	4.44	36.87	36.87	4.90	33.65	33.65	5.42		
1800 / 0.09	57 (14)	44.55	3.22	45.42	43.39	3.61	42.99	42.99	4.01	40.27	4.45	36.93	36.93	4.90	33.71	33.71	5.42		
	63 (17)	48.45	35.96	34.89	3.61	43.34	33.74	4.01	39.68	32.11	4.43	35.40	30.31	4.86	31.36	28.61	5.36		
	67 (19)	51.88	37.20	36.11	3.63	46.50	35.00	4.04	43.61	33.83	4.48	39.76	32.48	4.95	35.41	30.72	5.47		
1800 / 0.09	72 (22)	56.33	29.83	28.78	3.67	50.61	27.67	4.09	47.54	26.48	4.54	44.33	25.28	5.02	40.46	24.19	5.55		
	57 (14)	48.51	48.51	46.40	3.66	44.19	44.19	4.06	41.80	41.80	4.50	38.40	38.40	4.98	35.00	35.00	5.50		
	62 (17)	46.97	3.26	46.43	3.66	44.24	44.24	4.06	41.85	41.85	4.50	38.45	38.45	4.98	35.05	35.05	5.50		
1800 / 0.09	63 (17)	49.16	37.79	36.66	3.66	43.90	35.58	4.06	40.60	34.14	4.49	36.11	32.25	4.92	31.98	30.41	5.42		
	67 (19)	52.56	39.02	37.94	3.68	49.88	37.94	4.09	44.10	35.61	4.53	40.41	34.58	5.01	36.05	32.74	5.53		
	72 (22)	57.00	30.86	29.81	3.71	51.17	28.67	4.14	48.00	27.47	4.59	44.74	26.23	5.07	40.90	25.30	5.60		

# Heating Capacities

## PHJ348

INDOOR AIR		OUTDOOR COIL ENTERING AIR TEMPERATURES °F (°C)																							
		-10 (-23)			0 (-18)			10 (-12)			20 (-7)			30 (-1)			40 (4)			50 (10)			60 (16)		
		Capacity MBtuh		Total Sys kW	Capacity MBtuh		Total Sys kW	Capacity MBtuh		Total Sys kW	Capacity MBtuh		Total Sys kW	Capacity MBtuh		Total Sys kW	Capacity MBtuh		Total Sys kW	Capacity MBtuh		Total Sys kW	Capacity MBtuh		Total Sys kW
Return Air db °F (°C)	CFM	Total	Integ	Total	Integ	Total	Integ	Total	Integ	Total	Integ	Total	Integ	Total	Integ	Total	Integ	Total	Integ	Total	Integ	Total	Integ		
		65 (18)	1400	14.74	13.56	2.91	19.51	17.95	3.03	24.50	22.49	3.16	29.84	27.06	3.30	36.36	31.86	3.49	42.03	42.03	3.65	48.56	48.56	3.83	56.09
1600	14.97		13.78	2.93	19.78	18.20	3.05	24.81	22.77	3.17	30.21	27.40	3.29	36.69	32.15	3.47	42.45	42.45	3.61	49.14	49.14	3.77	56.41	56.41	3.93
1800	15.18		13.97	2.96	20.01	18.42	3.07	25.09	23.02	3.18	30.54	27.69	3.30	36.97	32.40	3.46	42.85	42.85	3.59	49.61	49.61	3.74	56.58	56.58	3.87
70 (21)	1400	14.15	13.01	3.03	18.92	17.41	3.16	23.91	21.95	3.29	29.23	26.51	3.44	35.88	31.44	3.65	41.47	41.47	3.81	47.90	47.90	4.01	55.42	55.42	4.22
	1600	14.38	13.23	3.06	19.20	17.66	3.17	24.23	22.24	3.30	29.61	26.85	3.43	36.25	31.76	3.62	41.91	41.91	3.77	48.47	48.47	3.95	55.82	55.82	4.12
	1800	14.58	13.42	3.09	19.44	17.89	3.19	24.51	22.49	3.31	29.91	27.12	3.44	36.54	32.02	3.61	42.30	42.30	3.75	48.94	48.94	3.91	56.01	56.01	4.06
75 (24)	1400	13.47	12.39	3.17	18.27	16.81	3.30	23.28	21.37	3.44	28.57	25.91	3.59	34.52	30.25	3.77	40.95	40.95	3.98	47.26	47.26	4.19	54.69	54.69	4.42
	1600	13.71	12.61	3.20	18.55	17.07	3.31	23.59	21.66	3.44	28.95	26.25	3.58	35.67	31.25	3.78	41.38	41.38	3.94	47.82	47.82	4.13	55.19	55.19	4.32
	1800	13.93	12.81	3.23	18.80	17.30	3.33	23.88	21.92	3.45	29.27	26.55	3.58	36.05	31.59	3.77	41.73	41.73	3.91	48.28	48.28	4.09	55.43	55.43	4.25

See Legend and Notes on page 16.

# PERFORMANCE DATA (CONT.)

## Cooling Capacities

### PHJ360

EVAPORATOR AIR		CONDENSER ENTERING AIR TEMPERATURES °F (°C)																	
		75 (24)			85 (29)			95 (35)			105 (41)			115 (46)			125 (52)		
		CFM / BF	EWB °F (°C)	Capacity MBtuh	Sens	Total Sys kW	Capacity MBtuh	Sens	Total Sys kW	Capacity MBtuh	Sens	Total Sys kW	Capacity MBtuh	Sens	Total Sys kW	Capacity MBtuh	Sens	Total Sys kW	
1750 / 0.07	57 (14)	54.52	54.52	4.20	52.33	52.33	4.64	49.95	49.95	5.15	47.38	47.38	5.72	44.60	44.60	6.38	41.59	41.59	7.12
	62 (17)	56.27	50.77	4.22	53.60	49.30	4.66	50.80	47.71	5.16	47.84	45.93	5.73	44.67	44.67	6.38	41.64	41.64	7.13
	63* (17)	56.95	41.26	4.23	54.26	39.89	4.67	51.36	38.44	5.17	48.25	36.89	5.74	44.95	44.95	6.38	41.42	41.42	7.12
2000 / 0.08	67 (19)	61.09	42.88	4.29	58.15	41.49	4.74	55.00	40.00	5.24	51.65	38.45	5.80	48.09	48.09	6.45	44.32	44.32	7.18
	72 (22)	66.41	34.97	4.38	63.15	33.61	4.83	59.71	32.21	5.33	56.05	30.72	5.89	52.18	52.18	6.53	48.10	48.10	7.26
	57 (14)	56.68	56.68	4.29	54.29	54.29	4.73	51.73	51.73	5.24	48.97	48.97	5.81	46.00	46.00	6.47	42.79	42.79	7.21
2250 / 0.09	62 (17)	57.54	54.21	4.30	54.80	52.58	4.74	51.96	50.72	5.24	49.03	49.03	5.81	46.05	46.05	6.47	42.84	42.84	7.21
	63 (17)	58.11	43.67	4.31	55.28	42.25	4.75	52.24	40.72	5.24	49.00	39.11	5.81	45.56	45.56	6.45	41.91	41.91	7.19
	67 (19)	62.22	45.44	4.37	59.12	43.99	4.82	55.82	42.46	5.31	52.33	40.83	5.88	48.65	48.65	6.52	44.74	44.74	7.24
2250 / 0.09	72 (22)	67.55	36.49	4.46	64.13	35.07	4.91	60.55	33.62	5.40	56.77	32.08	5.97	52.77	52.77	6.60	48.56	48.56	7.32
	57 (14)	58.41	58.41	4.38	55.86	55.86	4.82	53.14	53.14	5.32	50.22	50.22	5.90	47.08	47.08	6.55	43.72	43.72	7.28
	62 (17)	58.68	57.16	4.38	55.91	55.91	4.82	53.20	53.20	5.33	50.28	50.28	5.90	47.13	47.13	6.55	43.76	43.76	7.28
2250 / 0.09	63 (17)	58.96	45.93	4.38	56.01	44.46	4.82	52.86	42.90	5.32	49.50	41.22	5.88	45.99	45.99	6.52	42.28	42.28	7.25
	67 (19)	63.00	47.85	4.44	59.77	46.34	4.89	56.38	44.78	5.38	52.77	43.10	5.94	49.00	49.00	6.58	45.05	45.05	7.30
	72 (22)	68.37	37.89	4.53	64.84	36.45	4.98	61.16	34.96	5.48	57.25	33.36	6.04	53.15	53.15	6.67	48.87	48.87	7.39

# Heating Capacities

## PHJ360

INDOOR AIR		OUTDOOR COIL ENTERING AIR TEMPERATURES °F (°C)																							
		-10 (-23)			0 (-18)			10 (-12)			20 (-7)			30 (-1)			40 (4)			50 (10)			60 (16)		
		Return Air db °F (°C)	CFM	Capacity MBtuh	Total Sys kW	Capacity MBtuh	Total Sys kW	Capacity MBtuh	Total Sys kW	Capacity MBtuh	Total Sys kW	Capacity MBtuh	Total Sys kW	Capacity MBtuh	Total Sys kW	Capacity MBtuh	Total Sys kW	Capacity MBtuh	Total Sys kW						
65 (18)	1750	18.85	17.34	3.59	24.42	22.47	3.74	30.31	27.82	3.89	36.67	33.26	4.05	44.81	39.26	4.27	51.11	44.41	4.41	57.40	47.40	4.57	64.43	64.43	4.76
	2000	19.17	17.64	3.63	24.78	22.80	3.77	30.70	28.18	3.90	37.14	33.68	4.05	45.15	39.56	4.24	51.28	43.36	4.36	57.44	47.44	4.50	64.37	64.37	4.67
	2250	19.46	17.90	3.67	25.09	23.09	3.80	31.05	28.49	3.93	37.55	34.05	4.06	45.29	39.68	4.23	51.40	43.34	4.34	57.42	47.42	4.47	64.21	64.21	4.61
70 (21)	1750	17.97	16.54	3.74	23.63	21.75	3.91	29.57	27.14	4.07	35.90	32.56	4.23	44.24	38.77	4.48	50.62	42.62	4.62	56.88	47.99	4.79	63.78	63.78	4.99
	2000	18.29	16.83	3.78	23.99	22.07	3.93	29.96	27.50	4.08	36.36	32.98	4.22	44.70	39.17	4.44	50.85	42.62	4.57	56.96	47.99	4.72	63.74	63.74	4.89
	2250	18.58	17.10	3.82	24.31	22.37	3.96	30.31	27.82	4.10	36.76	33.34	4.23	44.98	39.41	4.42	50.96	42.62	4.55	56.97	47.99	4.68	63.66	63.66	4.83
75 (24)	1750	17.07	15.71	3.90	22.79	20.97	4.08	28.78	26.41	4.25	35.10	31.83	4.42	42.45	37.20	4.63	50.18	41.84	4.84	56.35	47.99	4.68	63.13	63.13	5.22
	2000	17.37	15.98	3.94	23.15	21.30	4.10	29.18	26.78	4.26	35.55	32.24	4.41	43.17	37.83	4.61	50.40	41.79	4.79	56.46	47.99	4.68	63.14	63.14	5.12
	2250	17.65	16.24	3.98	23.47	21.59	4.13	29.53	27.10	4.28	35.95	32.60	4.42	44.25	38.77	4.64	50.52	41.79	4.76	56.49	47.99	4.68	63.12	63.12	5.06

See Legend and Notes on page 16.

## PERFORMANCE DATA (CONT.)

### LEGEND

BF— Bypass Factor  
 db — Dry Bulb  
 edb— Entering Dry— Bulb  
 Ewb — Entering Wet— Bulb  
 KW — Total Unit Power Input  
 ldb— Leaving Dry— Bulb  
 lwb— Leaving Wet— Bulb  
 SHC — Sensible Heat Capacity (1000 Btuh)  
 TC — Total Capacity (1000 Btuh) (net)

\* At 75°F (23.9°C) entering dry bulb (Tennessee Valley Authority [TVA] rating conditions); all other at 80°F (26.75°C) entering dry bulb.

### COOLING NOTES:

1. Ratings are net; they account for the effects of the evaporator—fan motor power and heat.
2. Direct interpolation is permissible. Do not extrapolate.
3. The following formulas may be used:

$$t_{ldb} = t_{edb} - \frac{\text{Sensible capacity (Btuh)}}{1.10 \times \text{CFM}}$$

$$t_{lwb} = \frac{\text{Wet-bulb temperature corresponding to enthalpy}}{\text{air leaving evaporator coil } (t_{lwb})} = \frac{\text{total capacity (Btuh)}}{4.5 \times \text{CFM}}$$

Where:  $h_{ewb}$  = Enthalpy of air entering evaporator coil

4. The SHC is based on 80°F (26.7°C) edb temperature of air entering evaporator coil. Below 80°F (26.7°C) edb, subtract (corr factor x CFM) from SHC. Above 80°F (26.7°C) edb, add (corr factor x CFM) to SHC.

Correction Factor =  $1.10 \times (1 - \text{BF}) \times (\text{edb} + 80)$ .



**Filter Pressure Drop (IN. W.C.)**

UNIT SIZE PHJ3	FILTER SIZE in. (mm)	500	600	700	800	900	1000	1100	1200	1300	1400	1500	1600	1700	1800	1900	2000	2100	2200
24	20x20x1 (508x508 x25)	0.06	0.07	0.08	0.10	0.12	0.13	0.14	0.15	—	—	—	—	—	—	—	—	—	—
30	20x24x1 (508x610 x25)	—	—	—	0.08	0.09	0.10	0.11	0.13	0.14	0.15	0.16	—	—	—	—	—	—	—
36 – 42	24x30x1 (610x762 x25)	—	—	—	0.04	0.05	0.06	0.07	0.07	0.08	0.09	0.10	—	—	—	—	—	—	—
48 – 60	24x36x1 (610x914 x25)	—	—	—	—	—	—	—	0.06	0.07	0.07	0.08	0.09	0.09	0.10	0.11	0.12	0.13	0.14

**Accessory Electric Heat Pressure Drop (IN. W.C.)**

HEATER kW	CFM							
	800	1000	1200	1400	1600	1800	2000	2200
5–20	0.033	0.037	0.042	0.047	0.052	0.060	0.067	0.075

**Wet Coil Delivery\*— (Deduct 10% for 208–Volt Operation)**

230 VOLT HORIZONTAL DISCHARGE												
UNIT PHJ3	SPEED TAP	AIR DELIVERY <sup>2</sup>	EXTERNAL STATIC PRESSURE (IN. W.C.)									
			0.1	0.2	0.3	0.4	0.5	0.6	0.7	0.8	0.9	1.0
24	1	CFM	933	799	758	707	675	608	549	497	435	394
	2	CFM	1016	921	882	854	809	761	711	668	599	552
	3	CFM	1079	1041	1003	970	944	909	866	810	764	724
30	1	CFM	1052	1018	984	943	914	879	833	795	732	678
	2	CFM	1141	1107	1069	1036	1006	974	932	899	856	784
	3	CFM	1246	1213	1181	1144	1108	1078	1043	1015	973	931
36	1	CFM	1311	1253	1195	1136	1083	1023	958	895	818	729
	2	CFM	1413	1364	1313	1256	1203	1148	1084	1022	969	882
	3	CFM	1571	1525	1473	1423	1364	1313	1261	1210	1156	1090
42	1	CFM	1499	1434	1394	1349	1307	1273	1232	1169	1108	1038
	2	CFM	1568	1532	1497	1459	1407	1381	1346	1304	1252	1185
	3	CFM	1635	1593	1560	1523	1484	1439	1406	1369	1335	1264
48	1	CFM	1657	1625	1590	1554	1517	1486	1448	1417	1381	1340
	2	CFM	1707	1673	1644	1614	1586	1549	1515	1479	1449	1407
	3	CFM	1931	1900	1870	1840	1809	1778	1749	1714	1683	1646
60	1	CFM	1837	1798	1753	1716	1677	1637	1590	1549	1497	1445
	2	CFM	1910	1872	1835	1795	1748	1711	1673	1623	1568	1525
	3	CFM	2098	2065	2032	1996	1956	1917	1877	1839	1798	1753

\*Air delivery values are based on operating voltage of 230v, wet coil, without filter or electric heater. Deduct filter and electric heater pressure drops to obtain static pressure available for ducting.

**NOTES:**

1. Do not operate the unit at a cooling airflow that is less than 350 cfm for each 12,000 Btu/h of rated cooling capacity. Evaporator coil frosting may occur at airflows below this point.
2. Standard Cubic Feet per Minute.

ELECTRICAL DATA													
UNIT PHJ3	V-PH-HZ	RANGE				OFM	IFM	NOMINAL	FLA		MCA		MOCP **
		MIN	MAX	RLA	LRA	FLA	FLA	kW *	208	240	208	230	
24	208/230-1-60	197	253	12.8	58.3	0.9	2.8	-/-	-	-	19.7	19.7	30
								3.8/5	18.0	20.8	42.2	45.7	45/50
								5.6/7.5	27.0	31.3	53.5	58.8	60/60
								7.5/10	36.1	41.7	64.8	71.8	70/80
30	208/230-1-60	197	253	14.1	73.0	0.9	2.8	-/-	-	-	21.3	21.3	30
								3.8/5	18.0	20.8	43.8	47.3	45/50
								5.6/7.5	27.0	31.3	55.1	60.5	60/70
								7.5/10	36.1	41.7	66.5	73.5	70/80
36	208/230-1-60	197	253	16.7	79.0	1.5	4.1	-/-	-	-	26.5	26.5	40
								3.8/5	18.0	20.8	49.0	52.5	50/60
								5.6/7.5	27.0	31.3	60.2	65.6	70/70
								7.5/10	36.1	41.7	71.6	78.6	80/80
42	208/230-1-60	197	253	18.2	112.0	1.5	4.1	-/-	-	-	28.3	28.3	40
								3.8/5	18.0	20.8	50.8	54.3	60/60
								5.6/7.5	27.0	31.3	62.0	67.4	70/70
								7.5/10	36.1	41.7	73.4	80.4	80/90
48	208/230-1-60	197	253	22.3	117.0	1.5	6.0	-/-	-	-	35.4	35.4	50
								3.8/5	18.0	20.8	57.9	61.4	60/70
								5.6/7.5	27.0	31.3	69.1	74.5	70/80
								7.5/10	36.1	41.7	80.5	87.5	90/90
60	208/230-1-60	197	253	26.4	134.0	1.9	7.6	-/-	-	-	42.5	42.5	60
								3.8/5	18.0	20.8	65.0	68.5	70/70
								5.6/7.5	27.0	31.3	76.3	81.6	80/90
								7.5/10	36.1	41.7	87.6	94.6	90/100
								11.3/15	54.1	62.5	110.1	120.6	125/125
								15.0/20.0	72.1	83.3	132.6	146.6	150/150

\* kW @ 208/240

\*\* HACR Type Circuit breaker

LEGEND

FLA – Full Load Amps

LRA – Locked Rotor Amps

MCA – Minimum Circuit Amps

MOCP – Maximum Overcurrent Protection

RLA – Rated Load Amps

NOTES:

1. In compliance with NEC (National Electrical Code) requirements for multimotor and combination load equipment (refer to NEC Articles 430 and 440), the overcurrent protective device for the unit shall be Power Supply fuse. The CGA (Canadian Gas Association) units may be fuse or circuit breaker.

2. Minimum wire size is based on 60°C copper wire. If other than 60°C wire is used, or if length exceeds wire length in table, determine size from NEC.

\*Heater capacity (kW) based on heater voltage of 208v & 240v. If power distribution voltage to unit varies from rated heater voltage, heater kW will vary accordingly.

# TYPICAL INSTALLATION

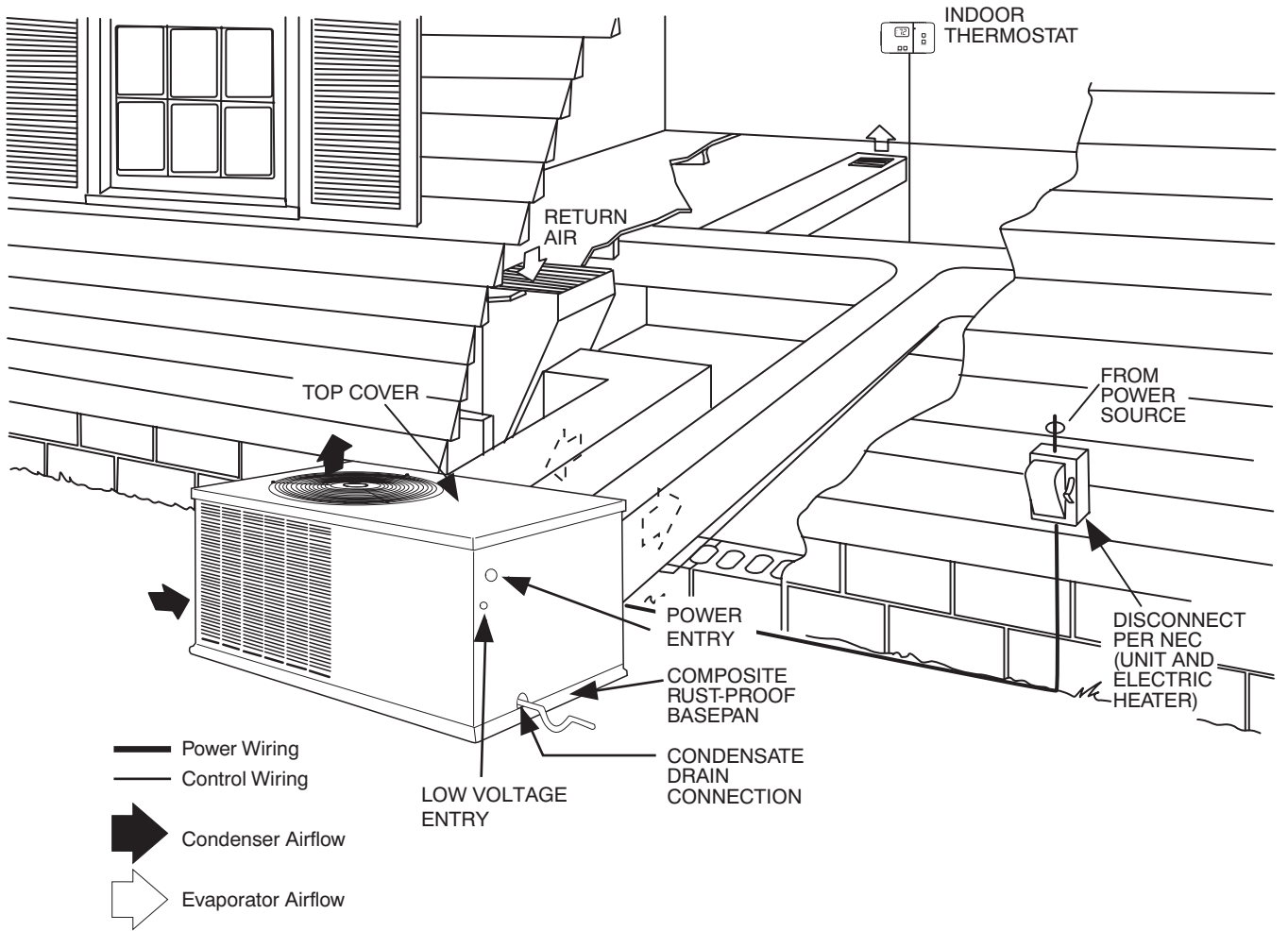

# TYPICAL CONNECTION WIRING SCHEMATIC 208/230-1-60

## CONNECTION WIRING DIAGRAM

**DANGER: ELECTRICAL SHOCK HAZARD DISCONNECT POWER BEFORE SERVICING**

USE COPPER CONDUCTORS ONLY  
FIELD SUPPLY POWER  
208/230 VAC, 60 HZ, 1PH

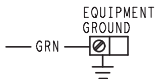

FOR WIRING WITH  
ELECTRIC HEATERS  
SEE SCHEMATIC  
ON HEATER ACCESSORY.

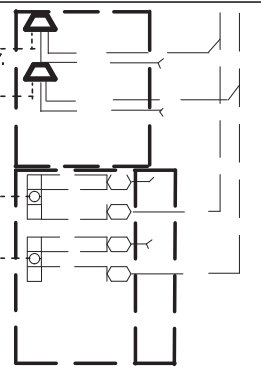

24 Volt  
Thermostat  
Connections

- R — RED
- O — ORN
- W2 — WHT
- Y — YEL
- C — BRN
- G — GRN

ACCESSORY  
ELECTRIC HEAT  
24 Volt  
Thermostat  
Connections  
(SEE NOTE 7)

- W3 — PNK
- W3 — VIO
- W2 — GRY
- W2 — WHT
- C — BRN

ACCESSORY ELECTRIC HEAT  
(24 VOLT HEATER RELAY CONNECTIONS)

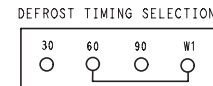
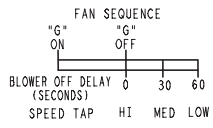
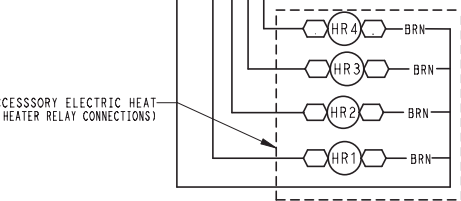
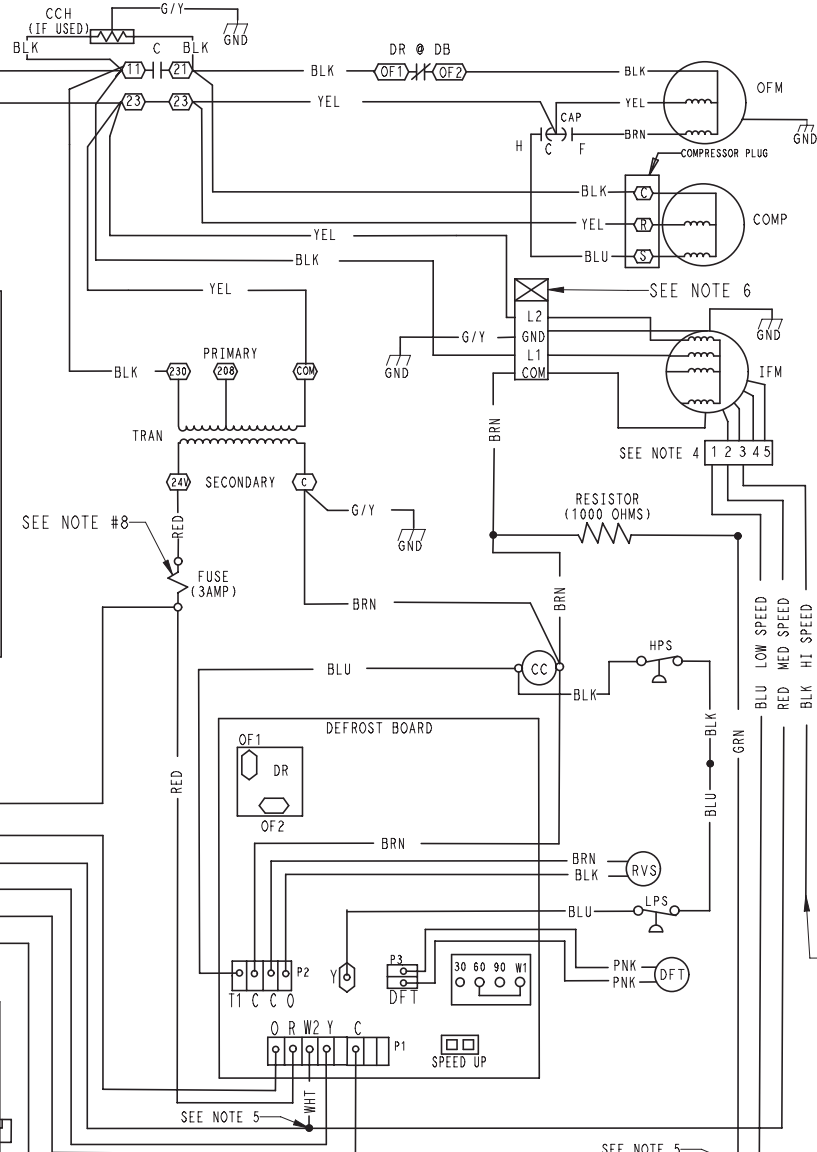

### COLOR CODE

- BLK BLACK
- BLU BLUE
- BRN BROWN
- GRN GREEN
- GRY GREY
- G/Y GREEN/YELLOW
- ORN ORANGE
- PNK PINK
- RED RED
- VIO VIOLET
- WHT WHITE
- YEL YELLOW

### LEGEND

- △ FIELD SPLICE
- TERMINAL (MARKED)
- TERMINAL (UNMARKED)
- SPLICE
- FACTORY WIRING
- - - FIELD CONTROL WIRING
- - - FIELD POWER WIRING
- - - ACCESSORY OR OPTIONAL WIRING
- C CONTACTOR
- CAP CAPACITOR
- CC CONTACTOR COIL
- CCH CRANK CASE HEATER
- COMP COMPRESSOR MOTOR
- DB DEFROST BOARD
- DFT DEFROST THERMOSTAT
- DR DEFROST RELAY
- GND GROUND
- HR HEATER RELAY
- IFM INDOOR FAN MOTOR
- LPS LOW PRESSURE SWITCH
- HPS HIGH PRESSURE SWITCH
- OFM OUTDOOR FAN MOTOR
- PLUG PLUG
- RVS REVERSING VALVE SOLENOID
- TRAN TRANSFORMER

### NOTES:

1. IF ANY OF THE ORIGINAL WIRES FURNISHED ARE REPLACED, IT MUST BE REPLACED WITH THE SAME TYPE OF WIRE OR IT'S EQUIVALENT
2. USE CONDUCTORS SUITABLE FOR AT LEAST 75°C (167°F)
3. FOR FIELD INSTALLATION.
4. FACTORY WIRING FOR SPEED SELECTOR PLUG
5. CHANGING OF SPEED TAPS MAY BE REQUIRED WHEN USING FIELD INSTALLED ELECTRIC HEATERS. CONSULT INSTALLATION INSTRUCTIONS TO DETERMINE CORRECT SPEED TAP SETTING.
6. \*DO NOT DISCONNECT PLUG UNDER LOAD.\*
7. MULTI-STAGE HEATER SHOWN. SINGLE STAGE HEATERS HAVE WHITE AND BROWN WIRES ONLY.
7. FUSE MANUFACTURED BY LITTELFUSE, P/N 257003.

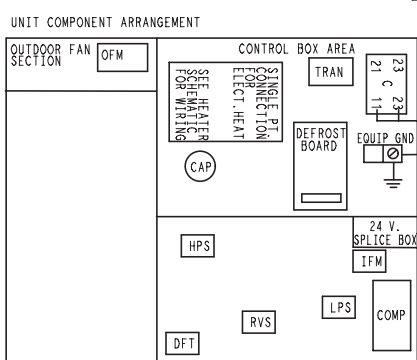

# TYPICAL LADDER WIRING SCHEMATIC 208/230-1-60

## LADDER WIRING DIAGRAM

DANGER: ELECTRICAL SHOCK HAZARD DISCONNECT POWER BEFORE SERVICING

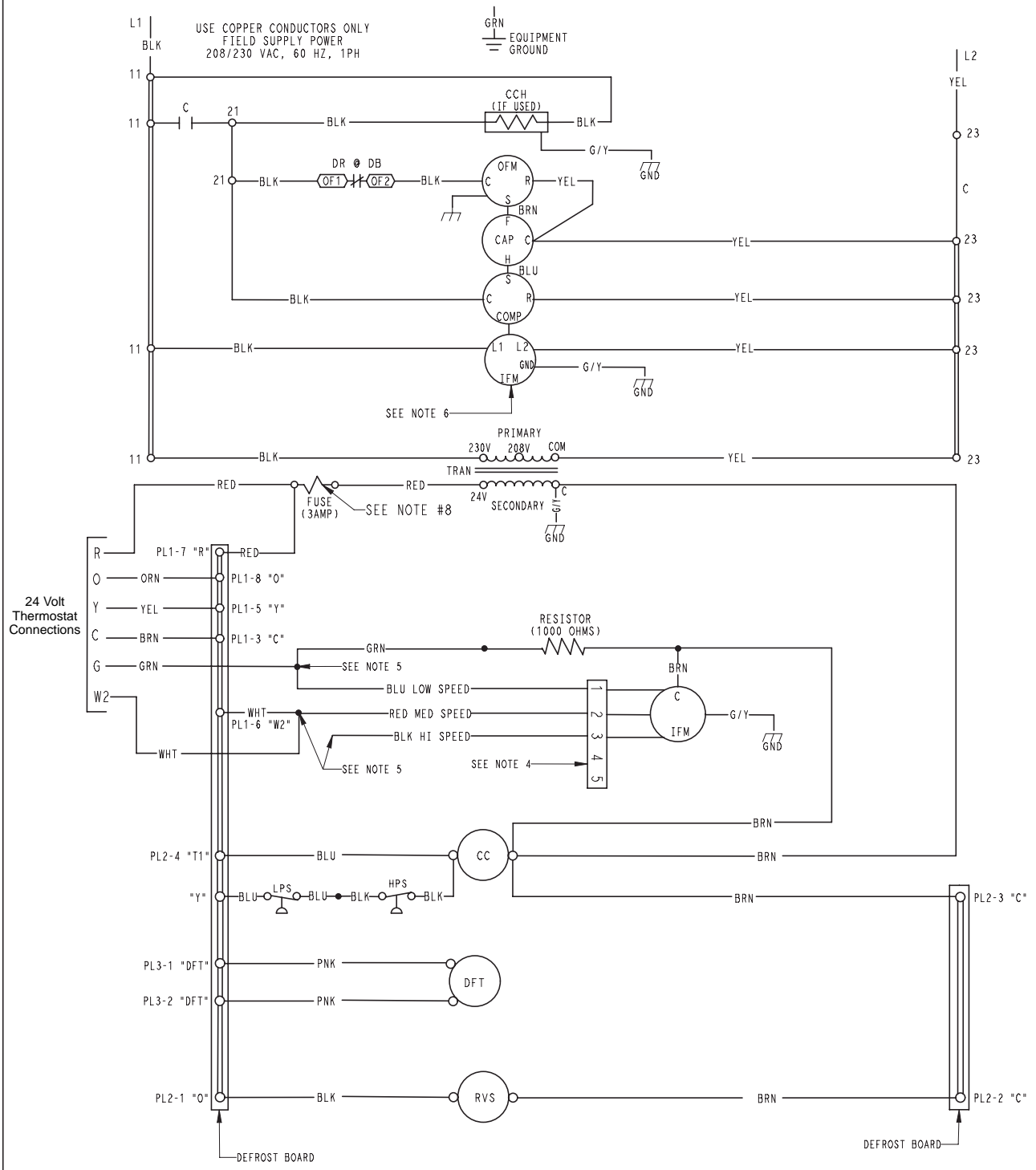

50ZH500517 A

# TYPICAL FIELD WIRING

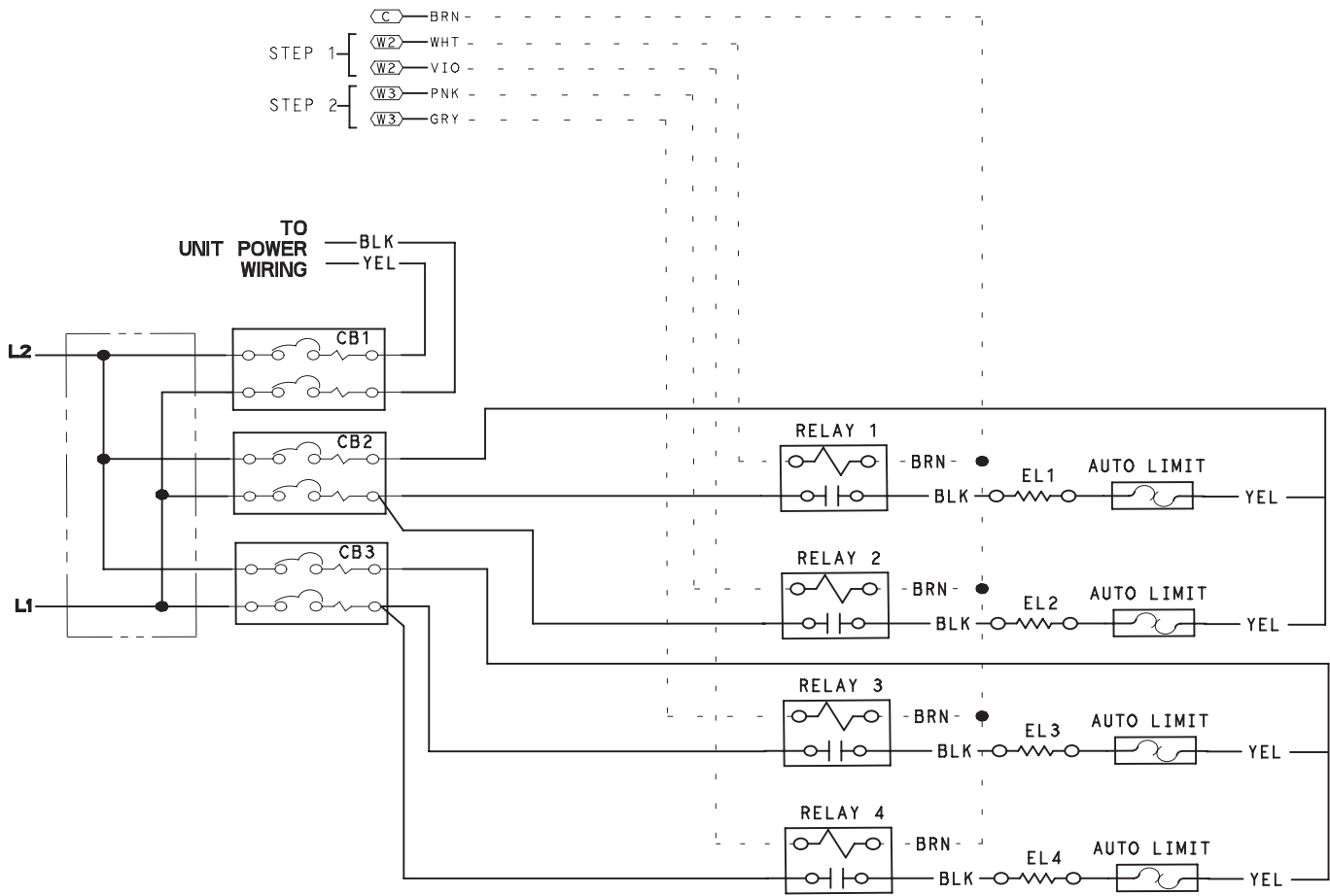

Note: 20 kW shown. Smaller heater have fewer elements and controls.

## CONTROLS

### Sequence of operation

When power is supplied to unit, the transformer (TRAN) is energized.

**Cooling Operation** — With a call for cooling (O,Y,G), the reversing valve, contactor, and indoor fan are energized. When the cooling demand is met, Y and G are de-energized, shutting off the contactor (compressor, outdoor fan). The indoor fan stops after a 60 second delay.

**Heating Operation** — With a call for heating (Y,G), the contactor and indoor fan are energized. When the heating demand is met, Y and G are de-energized, shutting off the contactor (compressor, outdoor fan). The indoor fan stops after a 60 second delay.

**Continuous Fan** — With the continuous indoor fan option selected on the thermostat, G is continuously energized keeping the indoor fan running at all times.

**Defrost** — The defrost control is a time/temperature control which includes a field-selectable time period between defrost cycles of 30, 60, and 90 minutes. Electronic timer and defrost cycle start only when contactor is energized and defrost thermostat (DFT) is closed.

Defrost mode is identical to cooling mode, except outdoor fan motor stops and a bank of optional electric heat turns on to warm air supplying the conditioned space.

## APPLICATION DATA

Condensate trap — A 2-in. (51 mm) condensate trap must be field supplied.

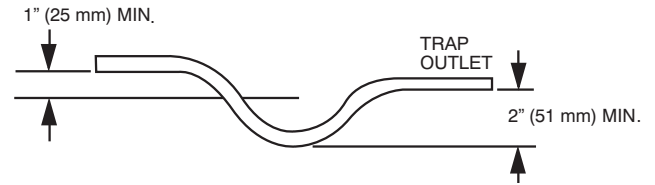

**Maximum cooling airflow** — To minimize the possibility of condensate blow-off from the evaporator, airflow through the units should not exceed 450 CFM/ton.

**Minimum cooling airflow** — The minimum cooling airflow is 350 cfm/ton.

**Minimum cooling operating outdoor air temperature** — All standard units have a minimum ambient operating temperature of 40°F (4.4°C). With accessory low ambient temperature kit, units can operate at temperatures down to 0°F (-17.8°C).

**Maximum operating outdoor air temperature** — Maximum outdoor operating air temperature for cooling is 125°F (51.7°C).

## GUIDE SPECIFICATIONS

### SMALL PACKAGED PRODUCT AIR-TO-AIR HEAT PUMP CONSTANT VOLUME APPLICATION

#### HVAC GUIDE SPECIFICATIONS

SIZE RANGE: 2 TO 5 TONS, NOMINAL (COOLING)

#### MODEL NUMBER: PHJ3

#### PART I – GENERAL

##### SYSTEM DESCRIPTION

Outdoor packaged, electrically controlled, air-to-air heat pump utilizing a scroll compressor for heating and cooling duty. Unit shall discharge supply air horizontally as shown on contract drawings.

##### QUALITY ASSURANCE

- A. Unit shall be rated in accordance with AHRI Standards 210/240, and 270. Designed in accordance with UL Standard 1995.**
- B. Unit shall be designed to conform to ASHRAE 15.**
- C. Unit shall be UL listed as a total package for safety requirements.**
- D. Insulation and adhesive shall meet NFPA 90A requirements for flame spread and smoke generation.**

##### DELIVERY, STORAGE, AND HANDLING

Unit shall be stored and handled per manufacturer's recommendations.

#### PART 2– PRODUCTS

##### EQUIPMENT

##### A. General:

Factory-assembled, single piece, air-to-air heat pump. Contained within the unit enclosure shall be all factory wiring, piping, controls, and refrigerant charge (R-410A).

##### B. Unit Cabinet:

1. Unit cabinet shall be constructed of phosphated, bonderized, zinc-coated, prepainted steel.
2. Basepan shall be made of a single-piece non-corrosive, composite material.
3. Indoor fan compartment cabinet surfaces shall be insulated with a minimum 1/2 in. (12.7 mm) thick, flexible insulation, coated on the air side, with aluminum foil-faced insulation.
4. Cabinet panels shall be easily removable for servicing.
5. Unit shall have a factory-installed, sloped, noncorrosive, condensate drain.
6. Unit insulation conforms to ASHRAE 62P.

##### C. Fans:

1. Indoor Blower (Indoor Fan):
  - a. Fan shall be multispeed, direct drive as shown on the equipment drawings.
  - b. Fan wheel shall be made from steel, be double-inlet type. It shall have forward-curved blades with a corrosion-resistant finish and shall be dynamically balanced.
2. Outdoor fan shall be of the direct-driven propeller type with aluminum blades, riveted to corrosion-resistant steel spiders. It shall be dynamically balanced, and shall discharge air upwards.

##### D. Compressor:

Fully-hermetic scroll type with external vibration isolation.

##### E. Coils:

1. Indoor and outdoor coils shall have aluminum-plate fins mechanically bonded to seamless copper tubes with all joints brazed.
2. Tube sheet openings shall be bellied to prevent tube wear.
3. Outdoor coil shall be protected by metal louvered panels.

##### F. Refrigerant Components:

1. TXV and AccuRater feed system.
2. Service gauge connections on suction and discharge lines.
3. Equipped with liquid line filter drier.
4. Equipped with accumulators on all sizes.

##### G. Controls and Safeties:

1. Unit Controls:
  - a. Unit shall be complete with self-contained low voltage control circuit.
  - b. Unit shall incorporate an outdoor coil defrost system to prevent excessive frost accumulation during heating cycle and shall be controlled as follows:
    - (1.) Defrost shall be initiated on the basis of time and coil temperature.
    - (2.) A 30/60/90-minute timer shall activate defrost cycle only if coil temperature is low enough to indicate a heavy frost condition.
    - (3.) Defrost cycle shall terminate when defrost thermostat is satisfied or shall have a positive termination time of 10 minutes.



## GUIDE SPECIFICATIONS (CONT)

2. Safeties:
  - a. High Pressure Switch
  - b. Loss of Charge Switch

### H. Operating Characteristics:

1. Unit shall be capable of starting and running at 125°F (51.7°C) ambient outdoor temperature.
2. Compressor with standard controls shall be capable of operation down to 40°F (4.4°C) ambient outdoor temperature in cooling duty.
3. Compressor shall be capable of operation in heating cycle down to -20°F (-28.9°C) ambient outdoor-air temperature.
4. Unit shall be capable of simultaneous heating duty and defrost cycle operation when using electric heaters indicated in Section L, Special Features.

### I. Electrical Requirements:

All unit power wiring shall enter unit cabinet at a single location.

### J. Motors:

1. Compressor motors shall be of the refrigerant-cooled type with line break thermal and current overload protection.
2. All fan motors shall have permanently lubricated bearings and inherent automatic-reset thermal overload protection.
3. Outdoor-fan motor shall be totally enclosed.

### K. Grille

1. Louvered Grille:

Louvered grille shall be standard on all units.

### L. Special Features Available

1. Coil Options:

Shall include factory-installed optional tin-plated indoor coil.
2. Thermostat:

To provide for two-stage heating and one-stage cooling in addition to manual or automatic changeover and indoor fan control.
3. Low-Ambient Package:

Shall consist of a solid-state control and outdoor coil temperature sensor for controlling outdoor fan motor operation, which shall allow unit to operate down to 0°F (-17.8°C) outdoor ambient temperature in cooling.
4. Crankcase Heater:

Shall provide anti-floodback protection for low-load cooling applications.
5. Electric heaters:
  - a. Electric heater shall be available as a field-installed option.
  - b. Heater elements shall be open wire type, adequately supported and insulated with ceramic bushings.
  - c. Electric heater packages must provide single point power connection capability.
6. Compressor Start Kit:

Shall be available to give a boost to the compressor motor at each start-up.
7. Outdoor Thermostat Kit:

Thermostat allows for staging of electric heaters based on outdoor air temperature.