

80% ECM Single Stage Heating Furnace

EASIER TO SELL

- 80% AFUE
- Supports two-stage cooling units
- Flame roll-out sensors standard
- Category I venting
- Blocked vent switch
- Dehumidification feature in cooling
- 24 VAC humidifier terminal
- Electronic air cleaner terminal
- F8MXL model California NOx approved
- Certified to leak 2 percent or less of nominal air conditioning CFM delivered when pressurized to 1-inch Water Gauge with all present air inlets, air outlets, and condensate drain port(s) sealed

TOUGHER

- ECM blower motor
- Adjustable heating blower OFF delay
- Factory set blower ON delay
- RPJ aluminized steel heat exchanger
- High temperature limit control prevents overheating
- Direct ignition with Silicon Nitride ignitor
- One piece prepainted steel cabinet

QUIETER

- In-shot burners
- Insulated blower compartment

EASIER TO INSTALL AND SERVICE

- 33 1/3" (847mm) high, for ease of installation
- Innovative knobs for easy door removal and secure attachment
- Factory shipped for natural gas, with propane gas conversion kits available
- Four position – upflow/downflow/horizontal (left/right) installation
- Three position vent elbow capability
- Through the casing flue pipe for counterflow applications
- Common venting with other Category I appliances
- Masonry chimney adapter available
- Self diagnostics
- Slide out blower assembly

WARRANTY *

- 1 year No Hassle Replacement™ limited warranty
- 20 year heat exchanger limited warranty
- 5 year parts limited warranty
 - With timely registration, an additional 5 year parts limited warranty

* Applies to original purchaser/homeowner, some limitations may apply. See warranty certificate for complete details.



Illustrations and photographs are only representative. Some product models may vary.

WARNING

This furnace is not designed for use in mobile homes, trailers, or recreational vehicles. Such use could result in property damage and/or death.



ISO 9001
QMI-SAI Global



Use of the AHRI Certified TM Mark indicates a manufacturer's participation in the program. For verification of certification for individual products, go to www.ahrirectory.org.



Model	Size	Input (MBTUH)	Efficiency AFUE	Cooling Capacity CFM range @ .5 in. w.c. (125 Pa)	Dimensions H x W x D Inches (Millimeters)	Shipping Wt. Lbs (Kg)
F8MXN F8MXL	0451408A	44,000	80%	430 – 1035	33-1/3 x 14-3/16 x 29 (847 x 360 x 737)	104 (47)
	0701716A	66,000	80%	835 – 1460	33-1/3 x 17-1/2 x 29 (847 x 445 x 737)	126 (57)
	0902116A	88,000	80%	805 – 1665	33-1/3 x 21 x 29 (847 x 533 x 737)	140 (64)
	1102120A	110,000	80%	990 – 2040	33-1/3 x 21 x 29 (847 x 533 x 737)	152 (69)
	1352420A	132,000	80%	1125 – 2070	33-1/3 x 24-1/2 x 29 (847 x 622 x 737)	163 (74)

MODEL NUMBER IDENTIFICATION GUIDE										
DIGIT POSITION	1	2	3	4	5	6,7,8	9,10	11,12	13	14
F = Mainline	F	8	M	X	L	045	14	12	A	1
N = Entry	EFFICIENCY		POSITION		TYPE		FEATURE		HEAT INPUT	
8 = 80% AFUE										
M = Multiposition										
V = Variable Speed Blower Motor – ECM										
X = ECM Blower Motor										
S = Single-stage										
T = Two-stage										
N = Standard										
L = Low NOx										
045 = 44,000 BTU/hr										
070 = 66,000 BTU/hr										
090 = 88,000 BTU/hr										
110 = 110,000 BTU/hr										
135 = 132,000 BTU/hr										
14 = 14-3/16"										
17 = 17-1/2"										
21 = 21"										
24 = 24-1/2"										
08 = 800 CFM										
12 = 1200 CFM										
14 = 1400 CFM										
16 = 1600 CFM										
20 = 2000 CFM										
22 = 2200 CFM										
NOMINAL MAXIMUM COOLING AIRFLOW @ .5 IN. W.C.										
SALES (MAJOR) REVISION DIGIT										
ENGINEERING (MINOR) REVISION DIGIT										

ECM—Electronically Commutated Motor

ACCESSORIES PART NUMBER IDENTIFICATION GUIDE								
DIGIT POSITION	1	2	3	4	5, 6, 7	8, 9	10, 11	
N = Non-Branded	N	A	H	A	001	01	DH	
BRANDING		PRODUCT GROUP		KIT USAGE		MAJOR SERIES		
A = Accessory								
H = Heating								
A = Original								
B = 2nd Generation								
Product Identifier Number								
Package Quantity								
Type of Kit (Example: DH = Draft Hood – Chimney Adapter)								

PHYSICAL DATA						
NATURAL GAS		0451408A	0701716A	0902116A	1102120A	1352420A
OUTPUT CAPACITY BTUH* (Nonweatherized ICS) †	F8MXL Upflow, all F8MXN	36,000	53,000	72,000	90,000	107,000
	F8MXL Downflow/Horizontal	34,000	51,000	69,000	86,000	102,000
INPUT BTUH*	F8MXL Upflow, all F8MXN	44,000	66,000	88,000	110,000	132,000
	F8MXL Downflow/Horizontal	42,000	63,000	84,000	105,000	126,000
AFUE † *	Nonweatherized ICS	80.0	80.0	80.0	80.0	80.0
TRANSFORMER (24 volt)		40 VA				
CERTIFIED TEMP RISE RANGE - °F (°C)		30-60 (17-33)	25-55 (14-31)	35-65 (19-36)	30-60 (17-33)	40-70 (22-39)
CERTIFIED EXT STATIC PRESSURE	Heating	0.10	0.12	0.15	0.20	0.20
	Cooling	0.50	0.50	0.50	0.50	0.50
AIRFLOW CFM‡	Heating	735	1230	1345	1890	1865
	Cooling	1035	1460	1665	2040	2070
LIMIT CONTROL		SPST				
HEATING BLOWER CONTROL		Solid-State Time Operation				
BURNERS (Monoport)		2	3	4	5	6
GAS CONNECTION SIZE		1/2 inch NPT				
GAS VALVE (Redundant) Manufacturer		White-Rodgers				
Minimum Inlet Pressure (in. w.c.)		4.5 (Natural Gas)				
Maximum Inlet Pressure (in. w.c.)		13.6 (Natural Gas)				
IGNITION DEVICE		Hot Surface				
COOLING CAPACITY CFM range (.5 in. w.c.)		430 - 1035	835 - 1460	805 - 1665	990 - 2040	1125 - 2070

* Gas input ratings are certified for elevations to 2000 ft. (610 M). In USA, for elevations above 2000 ft. (610 M), reduce ratings 4 percent for each 1000 ft. (305 M) above sea level. Refer to National Fuel Gas Code NFPA 54/ANSI Z223.1-2009 Table F.4 or furnace Installation Instructions.

† Capacity in accordance with U.S. Government DOE test procedures.

‡ Airflow shown is for bottom only return-air supply in comfort mode (as shipped). For air delivery above 1800 CFM, see Air Delivery Table for other options. A filter is required for each return-air supply.

ICS — Isolated Combustion System

ELECTRICAL DATA							
F8MXN & F8MXL	VOLTS- HERTZ- PHASE	OPERATING VOLTAGE RANGE*		MAXIMUM UNIT AMPS	MAXIMUM WIRE LENGTH FT (M)‡	MAXIMUM FUSE OR CKT BKR AMPS†	MINIMUM WIRE GAGE
		Maximum	Minimum				
0451408A	115-60-1	127	104	8.1	34 (10)	15	14
0701716A	115-60-1	127	104	10.8	26 (8)	15	14
0902116A	115-60-1	127	104	11.4	25 (7)	15	14
1102120A	115-60-1	127	104	14.2	31 (9)	20	12
1352420A	115-60-1	127	104	14.2	31 (9)	20	12

* Permissible limits of the voltage range at which the unit operates satisfactorily.

† Time-delay type is recommended.

‡ Length shown is as measured 1 way along wire path between unit and service panel for maximum 2 percent voltage drop.

UNIT DIMENSIONS

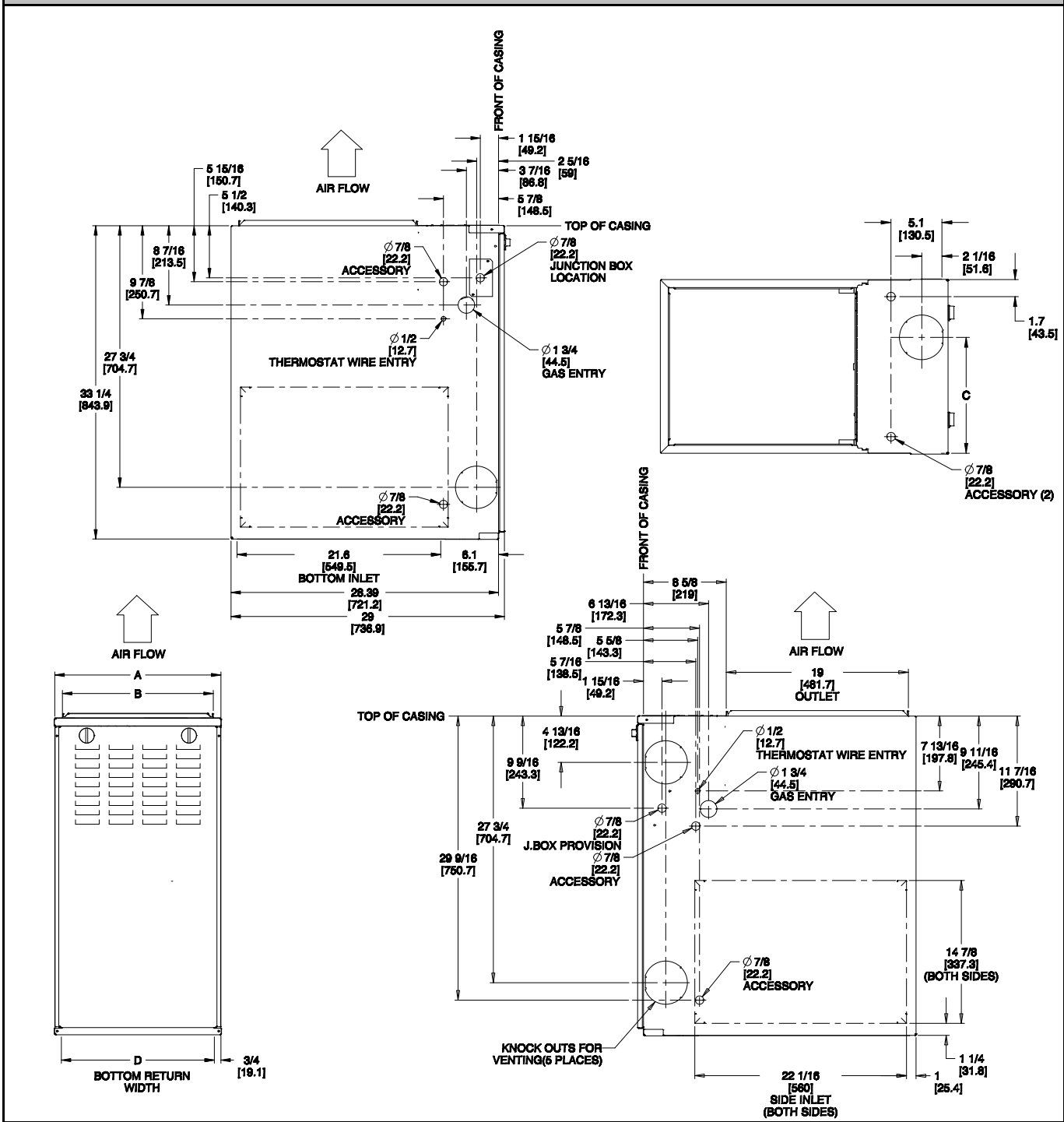

NOTES:

1. Two additional 7/8 inch (22 mm) diameter holes are located in the top plate.
2. Minimum return-air openings at furnace, based on metal duct. If flex duct is used, see flex duct manufacturer's recommendations for equivalent diameters.
 - a. For 800 CFM—16 inch (406 mm) round or 14-1/2 x 12 inch (368 x 305 mm) rectangle.
 - b. For 1200 CFM—20 inch (508 mm) round or 14-1/2 x 19-1/2 inch (368 x 495 mm) rectangle.
 - c. For 1600 CFM—22 inch (559 mm) round or 14-1/2 x 22-1/16 inch (368 x 560mm) rectangle.
 - d. For airflow requirements above 1800 CFM, see Air Delivery table in Product Data literature for specific use of single side inlets. The use of both side inlets, a combination of 1 side and the bottom, or the bottom only will ensure adequate return air openings for airflow requirements above 1800 CFM.

F8MXN & F8MXL	A	B	C	D	VENT CONNECTION SIZE (see Notes 1 & 2)	SHIP WT LB (KG)
	CABINET WIDTH IN (MM)	OUTLET WIDTH IN (MM)	TOP AND BOTTOM OUTLET IN (MM)	BOTTOM INLET WIDTH IN (MM)		
0451408A	14-3/16 (360)	12-9/16 (319)	9-5/16 (237)	12-11/16 (322)	4	104 (47)
0701716A	17-1/2 (445)	15-7/8 (403)	11-9/16 (294)	16-1/8 (410)	4	126 (57)
0902116A	21 (533)	19-3/8 (492)	13-5/16 (338)	19-1/2 (495)	4	140 (64)
1102120A	21 (533)	19-3/8 (492)	13-5/16 (338)	19-1/2 (495)	4	152 (69)
1352420A	24-1/2 (622)	22-7/8 (581)	15-1/16 (383)	23 (584)	4 (Note 1)	163 (74)

1. 135 size furnaces require 5 inch (127 mm) vents. Use a 4-5 inch (102-127 mm) vent adaptor between furnace and vent stack.
2. See installation instructions for complete installation requirements.

VENT CONFIGURATIONS

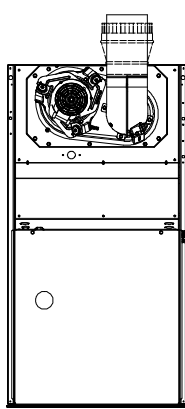

SEE NOTES: 1,2,4,7,8,9
UPFLOW

A02058

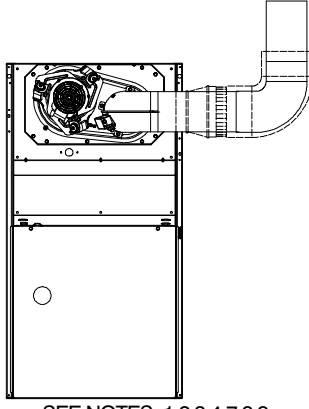

SEE NOTES: 1,2,3,4,7,8,9
UPFLOW

A02059

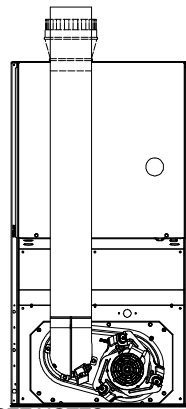

SEE NOTES: 1,2,4,5,7,8,9
DOWNFLOW

A02061

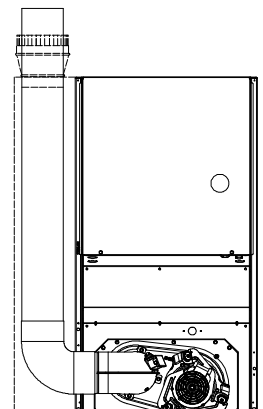

SEE NOTES: 1,2,4,5,6,7,8,9
DOWNFLOW

A02062

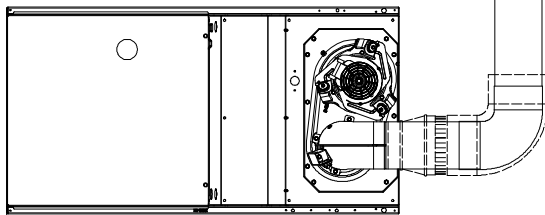

SEE NOTES: 1,2,4,7,8,9
HORIZONTAL RIGHT

A02069

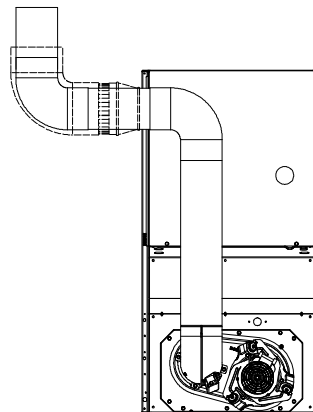

SEE NOTES: 1,2,3,4,5,7,8,9
DOWNFLOW

A02060

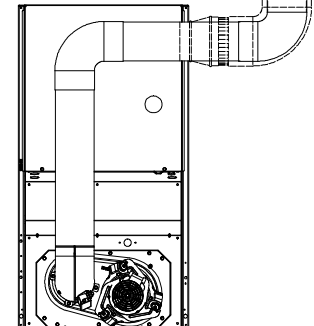

SEE NOTES: 1,2,3,4,5,7,8,9
DOWNFLOW

A02063

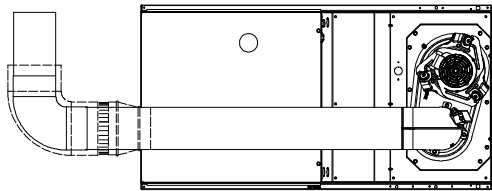

SEE NOTES: 1,2,4,5,7,8,9
HORIZONTAL RIGHT

A02068

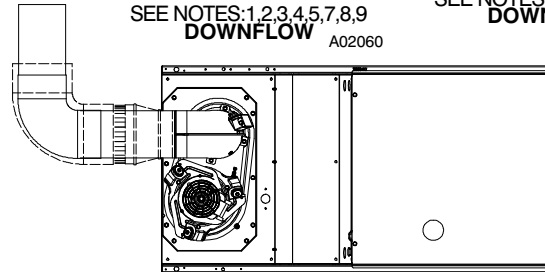

SEE NOTES: 1,2,4,7,8,9
HORIZONTAL LEFT

A02064

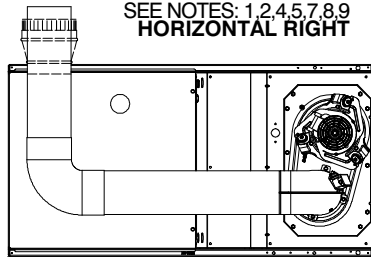

SEE NOTES: 1,2,4,5,7,8,9
HORIZONTAL RIGHT

A02070

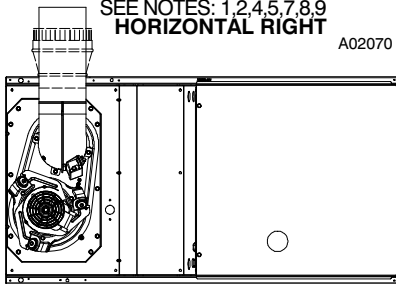

SEE NOTES: 1,2,4,5,7,8,9
HORIZONTAL LEFT

A02066

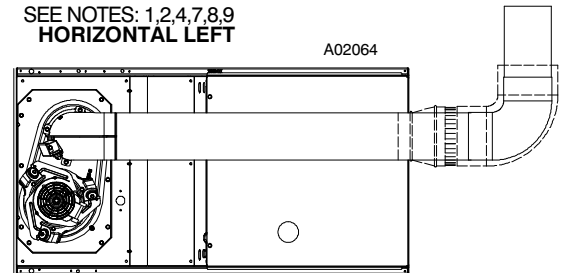

SEE NOTES: 1,2,4,5,7,8,9
HORIZONTAL LEFT

A02067

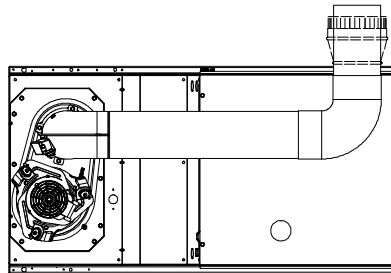

SEE NOTES: 1,2,4,5,7,8,9
HORIZONTAL LEFT

A02065

Venting Notes

1. For common vent, vent connector sizing and vent material: United States–use the NFGC.
2. Immediately increase to 5 inch (127 mm) or 6–inch (152 mm) vent connector outside furnace casing when 5 inch (127 mm) vent connector is required, refer to Note 1 above.
3. Side outlet vent for upflow and downflow installations must use Type B vent immediately after exiting the furnace, except when Downflow Vent Guard Kit, is used in the downflow position.
4. Type–B vent where required, refer to Note 1 above.
5. 4 inch single–wall (26 ga. min.) vent must be used inside furnace casing and when the Downflow Vent Guard Kit is used external to the furnace.
6. Accessory Downflow Vent Guard Kit, required in downflow installations with lower vent configuration.
7. Chimney Adapter Kit may be required for exterior masonry chimney applications. Refer to Chimney Adapter Kit, for sizing and complete application details.
8. Secure vent connector to furnace elbow with (2) corrosion–resistant sheet metal screws, spaced approximately 180° apart.
9. Secure all other single wall vent connector joints with (3) corrosion resistant screws spaced approximately 120° apart. Secure Type–B vent connectors per vent connector manufacturer’s recommendations.

MINIMUM CLEARANCES TO COMBUSTIBLE MATERIALS FOR ALL UNITS

This forced air furnace is equipped for use with natural gas at altitudes 0 – 10,000 ft (0 – 3,050m).

An accessory kit, supplied by the manufacturer, shall be used to convert to propane gas use or may be required for some natural gas applications.

This furnace is for indoor installation in a building constructed on site.

The furnace may be installed on combustible flooring in alcove or closet at minimum clearance as indicated by the diagram from combustible material.

This furnace may be used with a Type B–1 Vent and may be vented in common with other gas fired appliances.

This furnace is approved for UPFLOW, DOWNFLOW, and HORIZONTAL installations.

Downflow Positions:

- † Installation on non–combustible floors only. For Installation on combustible flooring only when installed on special base or coil assembly.
- ∅ 18 inch front clearance required for alcove.
- * Indicate supply or return sides when furnace is in the horizontal position. Line contact only permissible between lines formed by intersections of the Top and two Sides of the furnace jacket, and building joists, studs or framing.

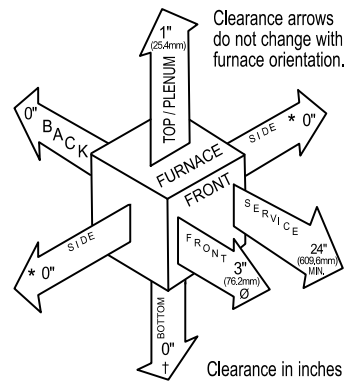

Vent Clearance to combustibles:

For Single Wall vents 6 inches (6 po).
For Type B-1 vent type 1 inch (1 po).

BLOWER PERFORMANCE DATA					
F8MXN & F8MXL	0451408	0701716	0902116	1102120	1352420
DIRECT-DRIVE MOTOR Hp (ECM)	1/2	3/4	3/4	1	1
MOTOR FULL LOAD AMPS	6.8	8.8	8.8	11.5	11.5
RPM (Nominal) – Speeds	1050–5	1050–5	1050–5	1050–5	1050–5
BLOWER WHEEL DIAMETER WIDTHS – in (mm)	10 x 6 (254 x 152)	11 x 8 (279 x 203)	10X10 (254 x 254)	11 x 11 (279 x 279)	11 x 11 (279 x 279)

PSC–Permanent Split Capacitor

AIR DELIVERY – CFM (with filter)*												
F8MXN & F8MXL	RETURN-AIR SUPPLY	SPEED	EXTERNAL STATIC PRESSURE (in. w.c.)									
			0.1	0.2	0.3	0.4	0.5	0.6	0.7	0.8	0.9	1
0451408	Bottom or Side(s)	5	1185	1145	1115	1075	1035	980	905	820	720	580
		4	920	880	835	800	755	720	680	645	605	540
		3	735	685	625	585	530	490	435	395	345	295
		2	820	765	725	670	630	580	545	490	455	405
		1	650	595	535	490	430	390	330	280	235	--
0701716	Bottom or Side(s)	5	1625	1585	1535	1495	1460	1415	1365	1295	1220	1125
		4	1405	1360	1320	1280	1240	1195	1155	1115	1070	1030
		3	1240	1200	1155	1110	1065	1020	975	935	895	850
		2	1190	1140	1095	1050	1000	955	915	870	830	790
		1	1035	985	930	885	835	785	745	695	650	600
0902116	Bottom or Side(s)	5	1845	1800	1755	1710	1665	1595	1500	1400	1275	1105
		4	1590	1545	1500	1455	1410	1365	1315	1270	1180	1000
		3	1365	1320	1270	1215	1170	1125	1070	1025	955	900
		2	1225	1160	1110	1060	1010	950	895	830	770	710
		1	1100	1030	960	875	805	730	645	570	505	425
1102120	Bottom or Side(s)	5	2255	2205	2150	2100	2040	1985	1920	1835	1735	1615
		4	1600	1525	1465	1400	1335	1275	1210	1150	1080	1015
		3	1945	1890	1830	1770	1715	1655	1600	1545	1480	1430
		2	1420	1340	1280	1200	1140	1065	1005	925	865	790
		1	1280	1205	1140	1055	990	910	840	760	695	630
1352420	Bottom or Side(s)	5	2295	2240	2185	2125	2070	2005	1925	1805	1670	1545
		4	1725	1660	1605	1545	1460	1395	1340	1285	1230	1170
		3	1910	1865	1800	1745	1685	1610	1545	1485	1435	1380
		2	1630	1575	1510	1435	1365	1300	1245	1185	1130	1065
		1	1430	1355	1285	1200	1125	1075	1015	945	855	800

*A filter is required for each return—air inlet. Airflow performance included washable filter media such as contained in factory—authorized accessory filter rack. To determine airflow performance without this filter, assume an additional 0.1 In. W.C. available external static pressure.

-- Indicates unstable operating conditions.

ACCESSORIES

PART NUMBER	DESCRIPTION	0451408	0701716	0902116	1102120	1352420
NAHB00501FF	External Bottom Filter Rack, 14 inch (14 x 25 inch washable filter included)	X				
NAHB00601FF	External Bottom Filter Rack, 17 inch (16 x 25 inch washable filter included)		X			
NAHB00701FF	External Bottom Filter Rack, 21 inch (20 x 25 inch washable filter included)			X	X	
NAHB00801FF	External Bottom Filter Rack, 24 inch (24 x 25 inch washable filter included)					X
NAHA00506FB†	Washable filter, 1 inch 16 x 25 (6 pack)		X			
NAHA00606FB	Washable filter, 1 inch 20 x 25 (6 pack)			X	X	
NAHA00706FB	Washable filter, 1 inch 24 x 25 (6 pack)					X
NAHA00806FB	Washable filter, 1 inch 14 x 25 (6 pack)	X				
NAHA00901FF	External Side Return Filter Rack 1 inch 16 x 25 (16 x 25 washable filter included)	X	X	X	X	X
NAHA01101SB	Combustible Floor Base (Not required when evaporator coil case is used for downflow)	X	X	X	X	X
NAHB00301VC	Downflow Vent Guard (Not required when vent is routed through cabinet)	X	X	X	X	X
NAHA00401DH	Chimney Adapter Kit 4-in. vent	X	X	X	X	
NAHA00301DH	Chimney Adapter Kit 5-in. vent					X
NAHA00801LP*	Natural-to-Propane Conversion Kit	X	X	X	X	X
NAHA00801NG*	Propane-to-Natural Conversion Kit	X	X	X	X	X
NAHB00301WL	Warning Label Kit	X	X	X	X	X

- X Accessory available
† Suitable for side return filter rack and 17 inch external bottom filter rack.
* Factory authorized and field installed. Gas conversion kits are CSA recognized.