

80% Variable Speed, Two-Stage Heating Furnace

EASIER TO SELL

- 80% AFUE
- Supports two-stage cooling units
- Flame roll-out sensors standard
- Category I venting
- Blocked vent switch
- Dehumidification feature in cooling
- 24 VAC humidifier terminal
- Electronic air cleaner terminal
- California NOx approved
- Certified to leak 2 percent or less of nominal air conditioning CFM delivered when pressurized to 1-inch Water Gauge with all present air inlets, air outlets, and condensate drain port(s) sealed

TOUGHER

- Variable speed ECM blower motor
- Adjustable heating blower OFF delay
- Factory set blower ON delay
- RPJ aluminized steel heat exchanger
- High temperature limit control prevents overheating
- Direct ignition with Silicon Nitride ignitor
- One piece prepainted steel cabinet

QUIETER

- Two-stage heating operation
- Two-stage induced draft blower
- In-shot burners
- Insulated blower compartment

EASIER TO INSTALL AND SERVICE

- 33-1/3" (847mm) high, for ease of installation
- Innovative knobs for easy door removal and secure attachment
- Factory shipped for natural gas, with propane gas conversion kits available
- Four position – upflow/downflow/horizontal (left/right) installation
- Three position vent elbow capability
- Through the casing flue pipe for counterflow applications
- Common venting with other Category I appliances
- Masonry chimney adapter available
- Self diagnostics
- Slide out blower assembly

WARRANTY *

- 10 year No Hassle Replacement™ limited warranty
- 20 year heat exchanger limited warranty
- 5 year parts limited warranty
 - With timely registration, an additional 5 year parts limited warranty

* Applies to original purchaser/homeowner, some limitations may apply. See warranty certificate for complete details.



Illustrations and photographs are only representative. Some product models may vary.

WARNING

This furnace is not designed for use in mobile homes, trailers, or recreational vehicles. Such use could result in property damage and/or death.



Use of the AHRI Certified TM Mark indicates a manufacturer's participation in the program. For verification of certification for individual products, go to www.ahridirectory.org.

ISO 9001:2000



Model Number	Input (MBTUH)	Efficiency AFUE	Cooling Capacity CFM range @ .5 in. w.c. (125 Pa)	Dimensions H x W x D Inches (Millimeters)	Shipping Wt. Lbs (Kg)
F8MVL0701412A	66,000	80%	485 – 1395	33-1/3 x 14-3/16 x 29 (847 x 360 x 737)	115 (52)
F8MVL0901716A	88,000	80%	475 – 1595	33-1/3 x 17-1/2 x 29 (847 x 445 x 737)	130 (59)
F8MVL1102120A	110,000	80%	700 – 2155	33-1/3 x 21 x 29 (847 x 533 x 737)	155 (70)
F8MVL1352422A	132,000	80%	665 – 2200	33-1/3 x 24-1/2 x 29 (847 x 622 x 737)	166 (75)

MODEL NUMBER IDENTIFICATION GUIDE										
DIGIT POSITION	1	2	3	4	5	6,7,8	9,10	11,12	13	14
F = Mainline	F	8	M	V	L	045	14	12	A	1
N = Entry	EFFICIENCY		POSITION		HEAT INPUT		CABINET WIDTH		NOMINAL MAXIMUM COOLING AIRFLOW @ .5 IN. W.C.	
8 = 80% AFUE										
M = Multiposition										
V = Variable Speed Blower Motor – ECM										
X = ECM Blower Motor										
S = Single-stage										
T = Two-stage										
N = Standard										
L = Low NOx										
045 = 44,000 BTU/hr										
070 = 66,000 BTU/hr										
090 = 88,000 BTU/hr										
110 = 110,000 BTU/hr										
135 = 132,000 BTU/hr										
14 = 14–3/16"										
17 = 17–1/2"										
21 = 21"										
24 = 24–1/2"										
08 = 800 CFM										
12 = 1200 CFM										
14 = 1400 CFM										
16 = 1600 CFM										
20 = 2000 CFM										
22 = 2200 CFM										
SALES (MAJOR) REVISION DIGIT										
ENGINEERING (MINOR) REVISION DIGIT										

ECM—Electronically Commutated Motor

ACCESSORIES PART NUMBER IDENTIFICATION GUIDE							
DIGIT POSITION	1	2	3	4	5, 6, 7	8, 9	10, 11
N = Non-Branded	N	A	H	A	001	01	DH
A = Accessory	BRANDING		PRODUCT GROUP		KIT USAGE		MAJOR SERIES
H = Heating							
A = Original							
B = 2nd Generation							
Product Identifier Number							
Package Quantity							
Type of Kit (Example: DH = Draft Hood – Chimney Adapter)							

PHYSICAL DATA						
NATURAL GAS			0701412A	0901716A	1102120A	1352422A
OUTPUT CAPACITY BTUH* (Nonweatherized ICS) †	Upflow	High	54,000	71,000	89,000	107,000
		Low	35,000	47,000	59,000	70,000
	Downflow/ Horizontal	High	51,000	68,000	85,000	102,000
		Low	35,000	47,000	59,000	70,000
INPUT BTUH*	Upflow	High	66,000	88,000	110,000	132,000
		Low	43,500	58,000	72,500	87,000
	Downflow/ Horizontal	High	63,000	84,000	105,000	126,000
		Low	43,500	58,000	72,500	87,000
TRANSFORMER (24 volt)			40 VA			
CERTIFIED TEMP RISE RANGE - °F (°C)		High	30-60 (17-33)	40-70 (22-39)	40-70 (22-39)	40-70 (22-39)
		Low	30-60 (17-33)	30-60 (17-33)	25-55 (14-30)	25-55 (14-30)
CERTIFIED EXT STATIC PRESSURE (in. w.c.)	Heating	High	0.12	0.15	0.20	0.20
	Cooling	Low	0.5	0.5	0.5	0.5
AIRFLOW CFM‡	Heating-High/Low		1180/735	1210/985	1475/1320	1915/1700
	Cooling		1225	1400	2095	2100
AFUE%*	Nonweatherized ICS		80.0	80.0	80.0	80.0
LIMIT CONTROL			SPST			
HEATING BLOWER CONTROL			Solid-State Time Operation			
BURNERS (Monoport)			2	2	3	3
GAS CONNECTION SIZE			1/2 inch NPT			
GAS VALVE (Redundant) Manufacturer			White-Rodgers			
Minimum Inlet Pressure (in. w.c.)			4.5 (Natural Gas)			
Maximum Inlet Pressure (in. w.c.)			13.6 (Natural Gas)			
IGNITION DEVICE			Hot Surface			
COOLING CAPACITY CFM range (.5 in. w.c.)			485 - 1395	475 - 1595	700 - 2155	665 - 2200

* Gas input ratings are certified for elevations to 2000 ft. (610 M). In USA, for elevations above 2000 ft. (610 M), reduce ratings 4 percent for each 1000 ft. (305 M) above sea level. Refer to National Fuel Gas Code NFPA 54/ANSI Z223.1-2009 Table F.4 or furnace Installation Instructions.

† Capacity in accordance with U.S. Government DOE test procedures.

‡ Airflow shown is for bottom only return-air supply in comfort mode (as shipped). For air delivery above 1800 CFM, see Air Delivery Table for other options. A filter is required for each return-air supply.

ICS — Isolated Combustion System

ELECTRICAL DATA							
F8MVL	VOLTS HERTZ PHASE	OPERATING VOLTAGE RANGE		MAXIMUM UNIT AMPS	MAXIMUM WIRE LENGTH FT (M)‡	MAXIMUM FUSE OR CKT BKR AMPS†	MINIMUM WIRE GAGE
		Maximum*	Minimum*				
0701412A	115-60-1	127	104	9.0	30 (9.1)	15	14
0901716A	115-60-1	127	104	9.6	29 (8.8)	15	14
1102120A	115-60-1	127	104	15.1	29 (8.8)	20	12
1352422A	115-60-1	127	104	14.9	30 (9.1)	20	12

* Permissible limits of the voltage range at which unit operates satisfactorily.

† Time-delay type is recommended.

‡ Length shown is as measured one way along wire path between unit and service panel for maximum 2 percent voltage drop.

UNIT DIMENSIONS

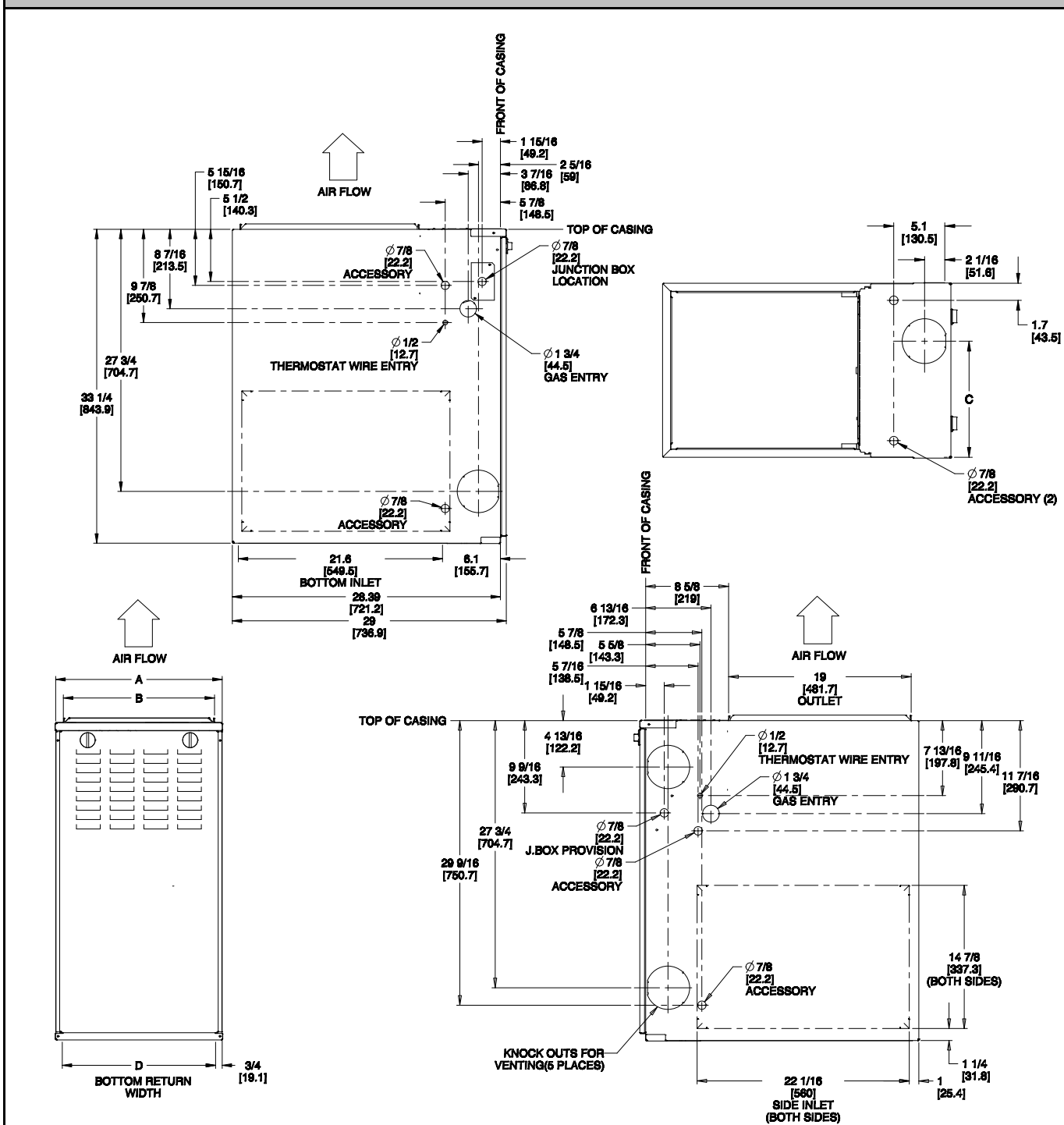

NOTES:

- Two additional 7/8 inch (22 mm) diameter holes are located in the top plate.
- Minimum return-air openings at furnace, based on metal duct. If flex duct is used, see flex duct manufacturer's recommendations for equivalent diameters.
 - For 800 CFM—16 inch (406 mm) round or 14-1/2 x 12 inch (368 x 305 mm) rectangle.
 - For 1200 CFM—20 inch (508 mm) round or 14-1/2 x 19-1/2 inch (368 x 495 mm) rectangle.
 - For 1600 CFM—22 inch (559 mm) round or 14-1/2 x 22-1/16 inch (368 x 560mm) rectangle.
 - For airflow requirements above 1800 CFM, see Air Delivery table in Product Data literature for specific use of single side inlets. The use of both side inlets, a combination of 1 side and the bottom, or the bottom only will ensure adequate return air openings for airflow requirements above 1800 CFM.

F8MVL	A	B	C	D	FLUE COLLAR* in (mm)	SHIPPING WT. LB (KG)
	CABINET WIDTH in (mm)	OUTLET WIDTH in (mm)	TOP AND BOTTOM FLUE COLLAR in (mm)	BOTTOM INLET WIDTH in (mm)		
0701412A	14-3/16 (360)	12-9/16 (319)	9-5/16 (237)	12-11/16 (322)	4 (102)	115 (52)
0901716A	17-1/2 (445)	15-7/8 (403)	11-9/16 (294)	16-1/8 (410)	4 (102)	130 (59)
1102120A	21 (533)	19-3/8 (492)	13-5/16 (338)	19-1/2 (495)	4 (102)	155 (70)
1352422A	24-1/2 (622)	22-7/8 (581)	15-1/16 (383)	23 (584)	4 (102)†	166 (75)

*5 inch or 6 inch (127 or 152 mm) vent connector may be required in some cases.

†5 inch (127 mm) or larger vent is required. Use a 4-5 inch (102-127 mm) or 4-6 inch (102-152 mm) vent adapter between furnace and vent connector.

VENT CONFIGURATIONS

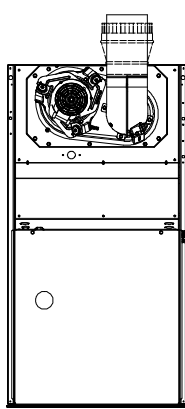

SEE NOTES: 1,2,4,7,8,9
UPFLOW

A02058

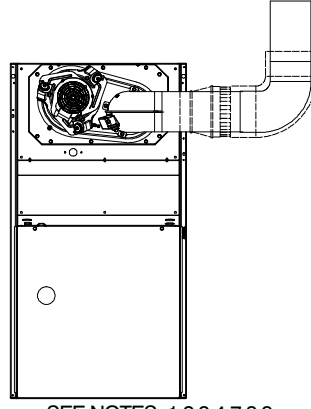

SEE NOTES: 1,2,3,4,7,8,9
UPFLOW

A02059

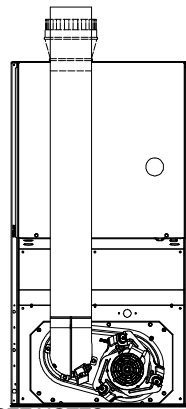

SEE NOTES: 1,2,4,5,7,8,9
DOWNFLOW

A02061

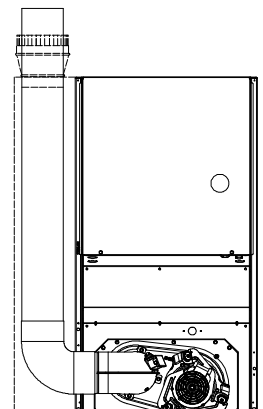

SEE NOTES: 1,2,4,5,6,7,8,9
DOWNFLOW

A02062

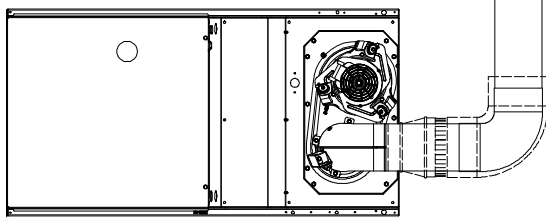

SEE NOTES: 1,2,4,7,8,9
HORIZONTAL RIGHT

A02059

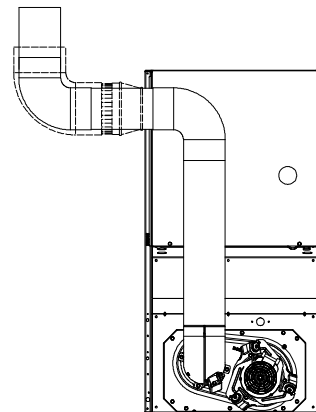

SEE NOTES: 1,2,3,4,5,7,8,9
DOWNFLOW

A02060

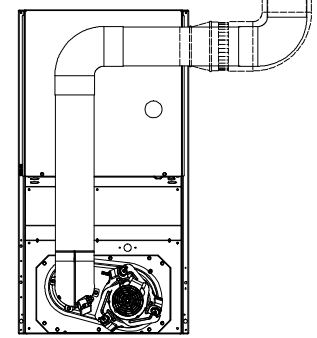

SEE NOTES: 1,2,3,4,5,7,8,9
DOWNFLOW

A02063

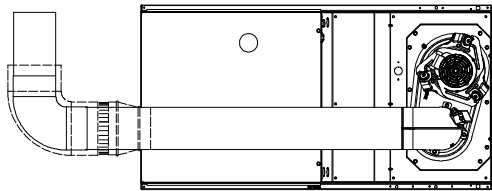

SEE NOTES: 1,2,4,5,7,8,9
HORIZONTAL RIGHT

A02068

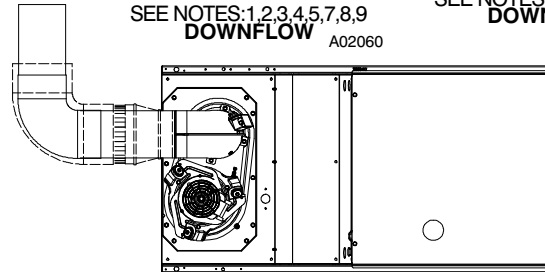

SEE NOTES: 1,2,4,7,8,9
HORIZONTAL LEFT

A02064

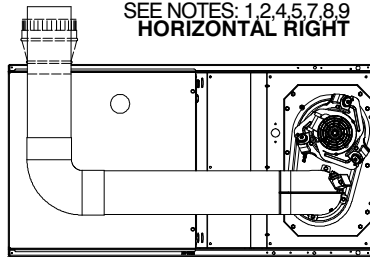

SEE NOTES: 1,2,4,5,7,8,9
HORIZONTAL RIGHT

A02070

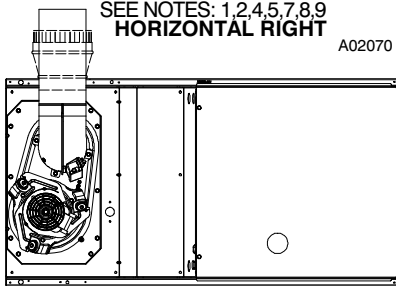

SEE NOTES: 1,2,4,5,7,8,9
HORIZONTAL LEFT

A02066

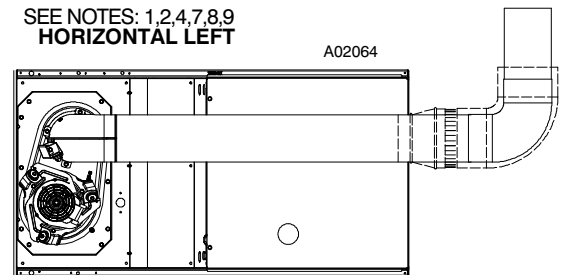

SEE NOTES: 1,2,4,5,7,8,9
HORIZONTAL LEFT

A02067

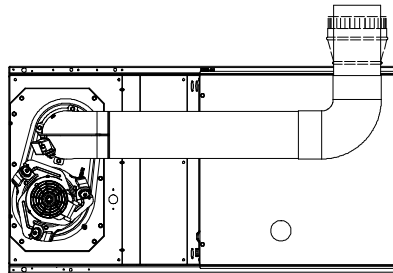

SEE NOTES: 1,2,4,5,7,8,9
HORIZONTAL LEFT

A02065

Venting Notes

1. For common vent, vent connector sizing and vent material: United States–use the NFGC.
2. Immediately increase to 5 inch (102 mm) or 6 inch (152 mm) vent connector outside furnace casing when 5 inch (127 mm) vent connector is required, refer to Note 1 above.
3. Side outlet vent for upflow and downflow installations must use Type B vent immediately after exiting the furnace, expect when Downflow Vent Guard Kit is used in the downflow position.
4. Type–B vent where required, refer to Note 1 above.
5. A 4 inch(102 mm) single–wall (26 ga. min.) vent must be used inside furnace casing and when the NAHB00301VC Downflow Vent Guard Kit is used external to the furnace.
6. Accessory Downflow Vent Guard Kit is required in downflow installations with lower vent configuration.
7. Chimney Adapter Kit may be required for exterior masonry chimney applications. Refer to Chimney Adapter Kit for sizing and complete application details.
8. Secure vent connector to furnace elbow with (2) corrosion–resistant sheet metal screws, spaced approximately 180° apart.
9. Secure all other single wall vent connector joints with (3) corrosion resistant screws spaced approximately 120° apart. Secure Type–B vent connectors per vent connector manufacturer’s recommendations.

MINIMUM CLEARANCES TO COMBUSTIBLE MATERIALS FOR ALL UNITS

This forced air furnace is equipped for use with natural gas at altitudes 0 – 10,000 ft (0 – 3,050m).

An accessory kit, supplied by the manufacturer, shall be used to convert to propane gas use or may be required for some natural gas applications.

This furnace is for indoor installation in a building constructed on site.

The furnace may be installed on combustible flooring in alcove or closet at minimum clearance as indicated by the diagram from combustible material.

This furnace may be used with a Type B–1 Vent and may be vented in common with other gas fired appliances.

This furnace is approved for UPFLOW, DOWNFLOW, and HORIZONTAL installations.

Downflow Positions:

- † Installation on non–combustible floors only.
For Installation on combustible flooring only when installed on special base or coil assembly.
- ∅ 18 inch front clearance required for alcove.
- * Indicate supply or return sides when furnace is in the horizontal position. Line contact only permissible between lines formed by intersections of the Top and two Sides of the furnace jacket, and building joists, studs or framing.

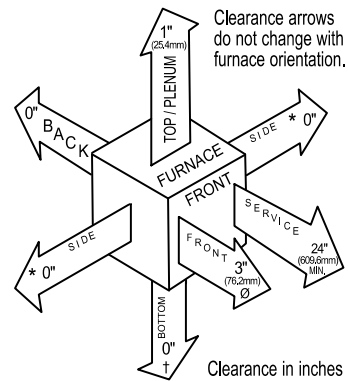

Vent Clearance to combustibles:

For Single Wall vents 6 inches (6 po).
For Type B-1 vent type 1 inch (1 po).

BLOWER PERFORMANCE DATA				
MODEL SIZE	F8MVL0701412A	F8MVL0901716A	F8MVL1102120A	F8MVL1352422A
DIRECT-DRIVE MOTOR Hp (ECM)	1/2	1/2	1	1
MOTOR FULL LOAD AMPS	7.7	7.7	12.8	12.8
RPM (Nominal)	300-1300	300-1300	300-1300	300-1300
BLOWER WHEEL DIAMETER X WIDTHS – in(mm)	10 x 6 (254 x 152)	10 x 8 (254 x 203)	11 x 10 (279 x 254)	11 x 11 (279 x 279)

AIR DELIVERY – CFM (with filter)*													
F8MVL	Operating Mode	CFM Airflow Setting	External Static Pressure Range* (In. W.C.)	0.1	0.2	0.3	0.4	0.5	0.6	0.7	0.8	0.9	1
0701412	AIRFLOW (CFM)												
††	Low Heat	735†	0–0.50	735	735	735	735	725					
	High Heat	1180†	0–1.0	1160	1165	1175	1180	1180	1180	1180	1180	1180	1175
††	1–1/2–Ton Cooling	525	0–0.50‡	515	500	500	490	485					
††	2–Ton A/C Cooling	700	0–0.50‡	690	680	675	680	675					
	2–1/2–Ton A/C Cooling	875	0–1.0‡	875	875	875	870	865	855	850	835	825	820
	3–Ton A/C Cooling	1050	0–1.0‡	1050	1050	1050	1050	1050	1050	1045	1035	1020	1000
	3–1/2–Ton A/C Cooling	1225	0–1.0	1220	1225	1225	1225	1225	1220	1205	1190	1185	1170
	Maximum	1400	0–1.0	1395	1400	1400	1400	1395	1385	1370	1340	1300	1245
0901716	AIRFLOW (CFM)												
	Low Heat	985†	0–1.0	950	970	985	985	985	985	985	985	985	980
	High Heat	1210†	0–1.0	1190	1205	1210	1210	1210	1210	1210	1210	1210	1200
††	1–1/2–Ton A/C Cooling	525	0–0.50‡	525	520	525	495	475					
††	2–Ton A/C Cooling	700	0–0.50‡	680	680	680	675	670					
	2–1/2–Ton A/C Cooling	875	0–1.0‡	815	845	845	855	850	850	845	835	820	805
	3–Ton A/C Cooling	1050	0–1.0‡	1005	1005	1015	1035	1040	1040	1035	1030	1025	1010
	3–1/2–Ton A/C Cooling	1225	0–1.0	1190	1200	1200	1205	1205	1215	1205	1200	1185	1170
	4–Ton A/C Cooling	1400	0–1.0	1350	1370	1390	1390	1400	1390	1380	1380	1360	1340
	Maximum	1600	0–1.0	1595	1600	1600	1600	1595	1555	1505	1465	1430	1390
1102120***	AIRFLOW (CFM)												
	Low Heat	1320†	0–1.0	1275	1295	1315	1320	1320	1320	1320	1320	1320	1315
	High Heat	1475†	0–1.0	1460	1465	1475	1475	1475	1475	1475	1475	1465	1465
††	2–Ton A/C Cooling	700	0–0.50‡	700	700	700	700	700					
††	2–1/2–Ton A/C Cooling	875	0–0.50‡	875	875	875	875	875					
††	3–Ton A/C Cooling	1050	0–0.50‡	1050	1050	1050	1050	1050					
	3–1/2–Ton A/C Cooling	1225	0–1.0‡	1225	1225	1225	1225	1225	1225	1225	1225	1225	1225
	4–Ton A/C Cooling	1400	0–1.0‡	1400	1400	1400	1400	1400	1400	1400	1400	1400	1400
	5–Ton A/C Cooling	1750	0–1.0‡	1750	1750	1750	1750	1750	1750	1750	1750	1740	1725
	6–Ton A/C Cooling	2100	0–1.0	2100	2100	2100	2100	2090	2075	2055	2040	2005	1970
	Maximum	2200	0–1.0	2200	2190	2190	2180	2155	2145	2125	2100	2080	2020
1352422	AIRFLOW (CFM)												
	Low Heat	1700†	0–1.0	1700	1700	1700	1700	1700	1695	1700	1695	1685	1670
	High Heat	1915†	0–1.0	1900	1905	1915	1915	1915	1915	1915	1915	1915	1915
††	2–Ton A/C Cooling	700	0–0.50‡	700	700	700	700	665					
††	2–1/2–Ton A/C Cooling	875	0–0.50‡	870	870	865	865	865					
††	3–Ton A/C Cooling	1050	0–0.50‡	1010	1030	1050	1050	1050					
	3–1/2–Ton A/C Cooling	1225	0–1.0‡	1155	1180	1200	1210	1220	1225	1225	1225	1225	1225
	4–Ton A/C Cooling	1400	0–1.0‡	1395	1400	1400	1400	1400	1400	1400	1390	1375	1355
	5–Ton A/C Cooling	1750	0–1.0‡	1740	1750	1750	1750	1735	1740	1735	1730	1715	1700
	6–Ton A/C Cooling	2100	0–1.0	2075	2085	2090	2100	2100	2100	2090	2080	2055	2025
	Maximum	2200	0–1.0	2180	2195	2200	2200	2200	2200	2185	2165	2140	2095

Air Delivery–CFM Notes

*Actual external static pressure (ESP) can be determined by using the fan laws (CFM 2 proportional to ESP); such as, a system with 1180 CFM at 0.5 ESP would operate at cooling airflow of 1050 CFM at 0.4 ESP and low–heating airflow of 735 CFM at 0.19 ESP.

† Efficiency airflow are shown in parenthesis. Efficiency is selected when the low–heat rise adjustment switch (SW1–3) is OFF and the comfort/efficiency switch (SW1–4) is OFF.

‡ Ductwork must be sized for high–heating CFM within the operational range of ESP.

***Wattage data provided is for the circulating blower with bottom return and does not include draft inducer, accessories, or gas controls.

†† Operation within the blank areas of the chart is not recommended because high–heat operation will be above 1.0 ESP.

***All airflow on 110 size furnace are 5% less on side return only installations.

ACCESSORIES

PART NUMBER	DESCRIPTION	0701412	0901716	1102120	1352422
NAHB00501FF	External Bottom Filter Rack, 14 inch (14 x 25 inch washable filter included)	X			
NAHB00601FF	External Bottom Filter Rack, 17 inch (16 x 25 inch washable filter included)		X		
NAHB00701FF	External Bottom Filter Rack, 21 inch (20 x 25 inch washable filter included)			X	
NAHB00801FF	External Bottom Filter Rack, 24 inch (24 x 25 inch washable filter included)				X
NAHA00506FB†	Washable filter, 1 inch 16 X 25 (6 pack)		X		
NAHA00606FB	Washable filter, 1 inch 20 X 25 (6 pack)			X	
NAHA00706FB	Washable filter, 1 inch 24 X 25 (6 pack)				X
NAHA00806FB	Washable filter, 1 inch 14 X 25 (6 pack)	X			
NAHA00901FF	External Side Return Filter Rack 1 inch 16 x 25 (16 x 25 washable filter included)	X	X	X	X
NAHA01101SB	Combustible Floor Base (Not required when evaporator coil case is used for downflow)	X	X	X	X
NAHB00301VC	Downflow Vent Guard (Not required when vent is routed through cabinet)	X	X	X	X
NAHA00401DH	Chimney Adapter Kit 4-in. vent	X	X	X	
NAHA00301DH	Chimney Adapter Kit 5-in. vent				X
NAHA00801LP*	Natural-to-Propane Conversion Kit	X	X	X	X
NAHA00801NG*	Propane-to-Natural Conversion Kit	X	X	X	X
NAHA00201HL	High Altitude Kit	X	X	X	X
NAHB00301WL	Warning Label Kit	X	X	X	X

- X Accessory available
† Suitable for side return filter rack and 17 inch external bottom filter rack.
* Factory authorized and field installed. Gas conversion kits are CSA recognized.