

**INSTALLATION INSTRUCTIONS
MODELS RXRD-01MDDAM3
VERTICAL AIRFLOW ECONOMIZERS**

▲ WARNING

THIS ACCESSORY IS TO BE INSTALLED BY A QUALIFIED, LICENSED SERVICE PERSON. TO AVOID UNSATISFACTORY OPERATION OR DAMAGE TO THE PRODUCT AND POSSIBLE UNSAFE CONDITIONS, INCLUDING ELECTRICAL SHOCK, REFRIGERANT LEAKAGE AND FIRE, THE INSTALLATION INSTRUCTIONS PROVIDED WITH THIS ACCESSORY MUST BE STRICTLY FOLLOWED AND THE PARTS SUPPLIED USED WITHOUT SUBSTITUTION. DAMAGE TO THE PRODUCT RESULTING FROM NOT FOLLOWING THE INSTRUCTIONS OR USING UNAUTHORIZED PARTS MAY BE EXCLUDED FROM THE MANUFACTURER'S WARRANTY COVERAGE.

▲ WARNING

DISCONNECT ELECTRICAL POWER TO THE UNIT. FAILURE TO DO SO CAN CAUSE ELECTRICAL SHOCK RESULTING IN PERSONAL INJURY OR DEATH.

▲ WARNING

ADDING POWERED EXHAUST MAY BE REQUIRED IN BUILDINGS WITH EXCESSIVE ENVELOPE AIR LOSSES AND/OR RESTRICTIVE RETURN AIR CONDITIONS TO THE UNIT PREVENTING ADEQUATE RETURN AIR TO THE UNIT WHEN ECONOMIZER IS OPEN TO OUTSIDE AIR.

TOOLS REQUIRED FOR INSTALLTION:

3/8" Electric drill with 5/16" socket

awl

TABLE 1

ITEM	DESCRIPTION	QTY	PART NO.
1	Economizer with actuator and outside air enthalpy sensor	1	
2	Economizer upper panel	1	
3	Hood left side	1	
4	Hood right side	1	
5	Hood divider	1	
6	Permanent water entrainment filter 20" x 20" x 1"	1	
7	JADE W7220 controller with attached wiring harness	1	
8	Hardware bag with mixed air temperature sensor	2	

Note: This economizer meets state and national codes for leakage. The economizer must be installed square with +/- 1/32" to maintain tight damper seal.

FIGURE 1

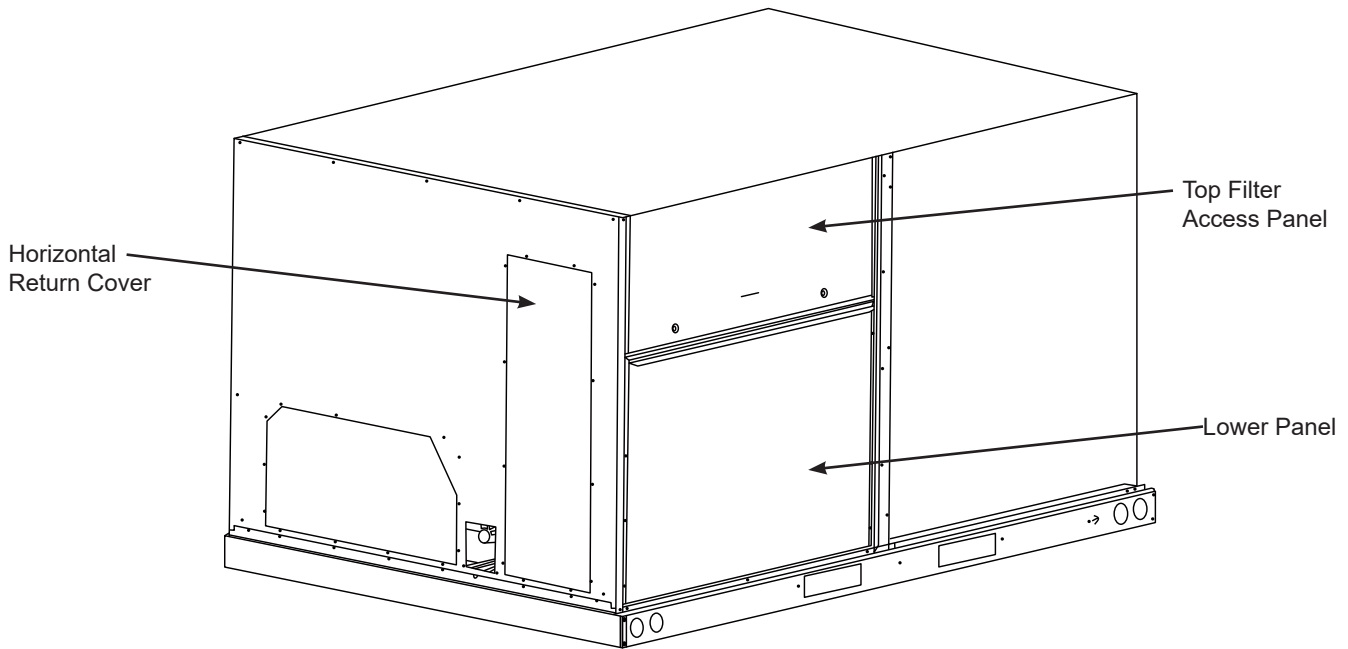

STEP 1:

Immediately upon receipt, all cartons and contents should be inspected for transit damage. Units with damaged cartons should be opened immediately. If damage is found, it should be noted on the delivery papers and a damage claim filed with the last carrier. Compare carton(s) contents to the PACKAGE CONTENTS List (**Table 1**) above to note any missing items.

STEP 2:

Remove HORIZONTAL RETURN COVER, TOP FILTER ACCESS DOOR, and LOWER PANEL from the unit and retain for reuse (**SEE FIGURE 1**). Retain screws. Note: the bottom panel will be used for the top of the economizer hood.

STEP 3:

Remove the jumper plug (PL7) from economizer harness in HVAC unit. Slide the economizer into the return air section (**SEE FIGURES 2 and 3**). Screw in place. After economizer is installed, connect unit's 12-pin ECONOMIZER PLUG (PL6??) to economizer mating plug (PL20??). If not using a field-installed smoke detector kit, reinstall the jumper plug (PL7) into other 12-pin plug from economizer – note this 12-pin plug will have only 3 wires connected to it. If using a field-installed smoke detector, discard the jumper plug (PL7) and install the smoke detector kit using provided instructions.

STEP 4:

Relocate the outside air enthalpy sensor from its shipping location to its operating position (**SEE FIGURE 3**). Screw in place. Remove the tape holding relief dampers closed.
Note: if using optional power exhaust kit, install it before the next step.

FIGURE 2

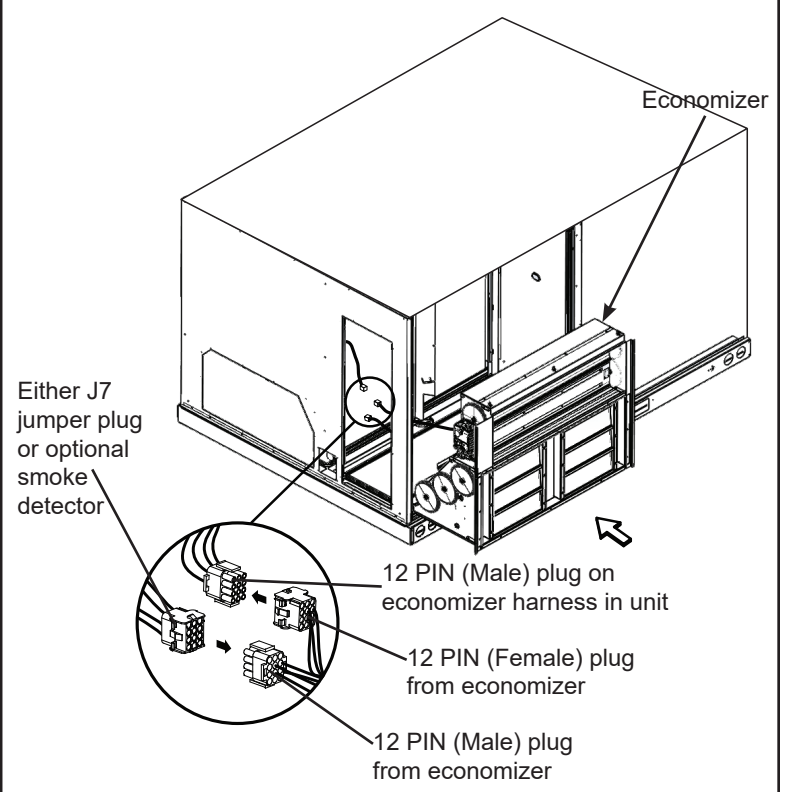

STEP 5:

Install UPPER ECONOMIZER PANEL onto unit, at top of economizer (**SEE FIGURE 4**). This panel provides a transition between the filter door and the hood top. Screw in place through pre-punched hole in panel and into top hole of economizer damper. To ensure proper location, UPPER PANEL will be 25 7/8" from bottom of unit as shown in **FIGURE 4**.

STEP 6:

Locate the LOWER PANEL removed in STEP 2 and slide it underneath the ECONOMIZER UPPER PANEL. Note the LOWER PANEL is used as the hood top. Insert LEFT HOOD SIDE and RIGHT HOOD SIDE under the LOWER PANEL. Screw hood together (**SEE FIGURE 5**).

STEP 7:

Install the HOOD DIVIDER between the LEFT HOOD SIDE and RIGHT HOOD SIDE (**SEE FIGURE 6**). Screw in place. Insert the permanent filter into the hood using the hood divider to rest the filter on, and using filter clips at top of hood to retain it in place (**SEE FIGURE 7**).

STEP 8:

With all line high voltage to unit disconnected, remove the panel on back side of unit covering the unit's electrical control box. The Honeywell JADE W7220 controller is provided with an attached wiring harness installed, and must be field-installed in the control box of the unit as shown in **FIGURE 8** below. The mounting holes for the JADE controller are pre-punched to ensure proper location. The unit's economizer harness factory-mounted in the unit is factory-plugged into the unit control board inside the unit control compartment. The plug on the end of the unit's economizer harness has 12-pin terminals.

Unplug the unit's economizer harness from the unit terminal board, and reconnect it to the female 12-pin plug on the JADE W7220 controller harness. Connect the 12-pin male plug on the JADE W7220 controller harness onto the unit's terminal board. See wiring diagram in this instruction.

Note: mixed air / discharge sensor has been factory installed and wired in unit for economizer use.

STEP 9:

Install all other kits including carbon dioxide sensor, dual enthalpy upgrade kit, etc.

STEP 10:

Reinstall the unit's horizontal return panel and the filter access panel.

STEP 11:

Upon unit startup, follow the JADE W7220 economizer controller setup instructions on the following pages.

FIGURE 3

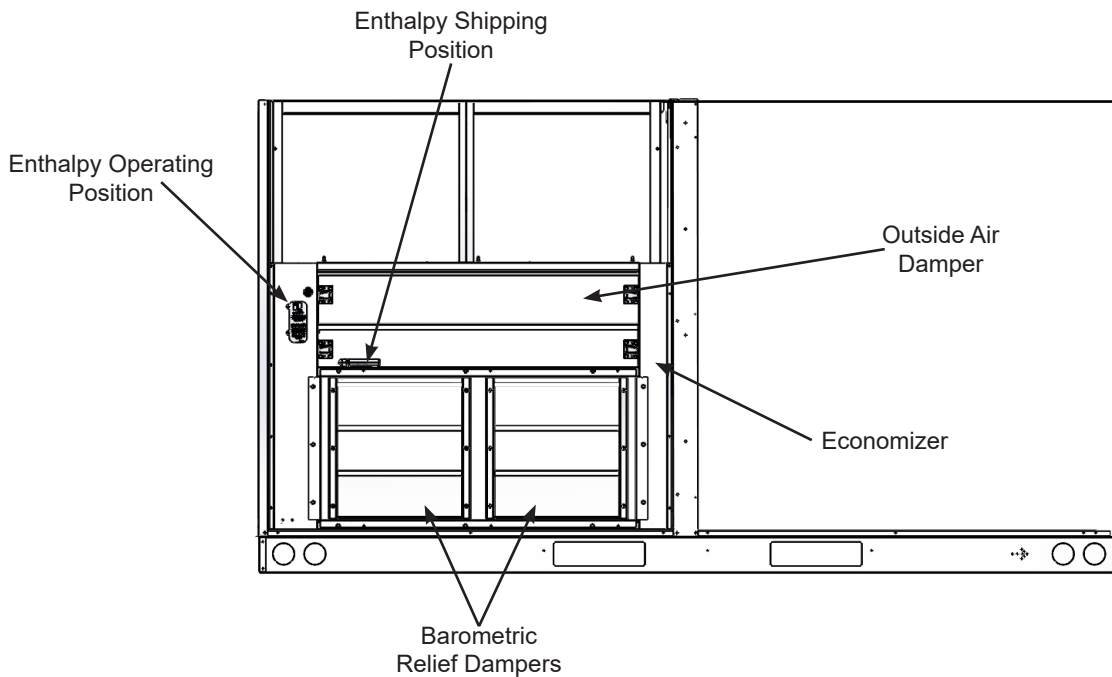

FIGURE 4

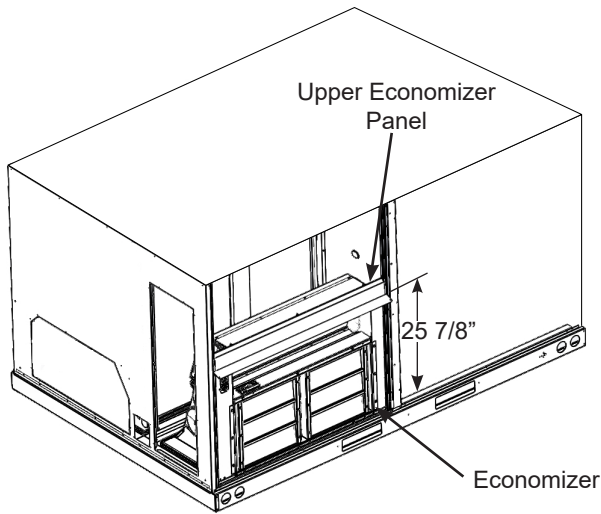

FIGURE 5

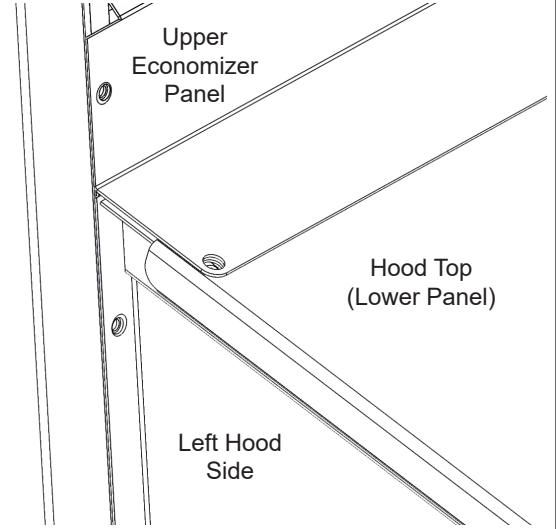

FIGURE 6

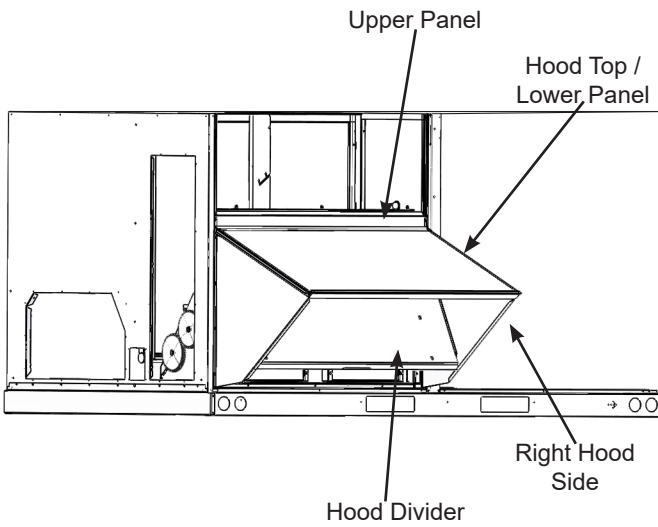

FIGURE 7

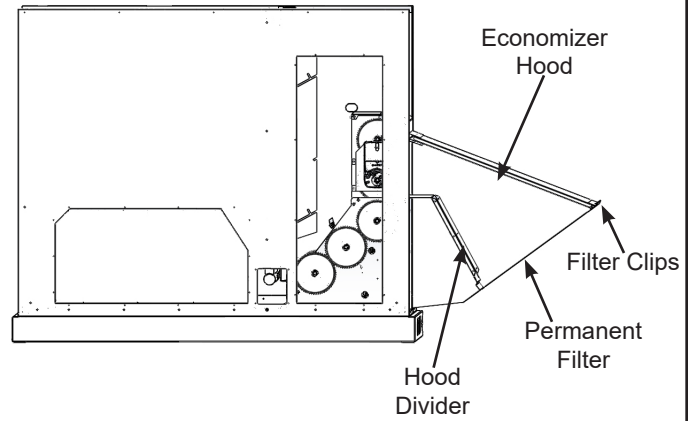
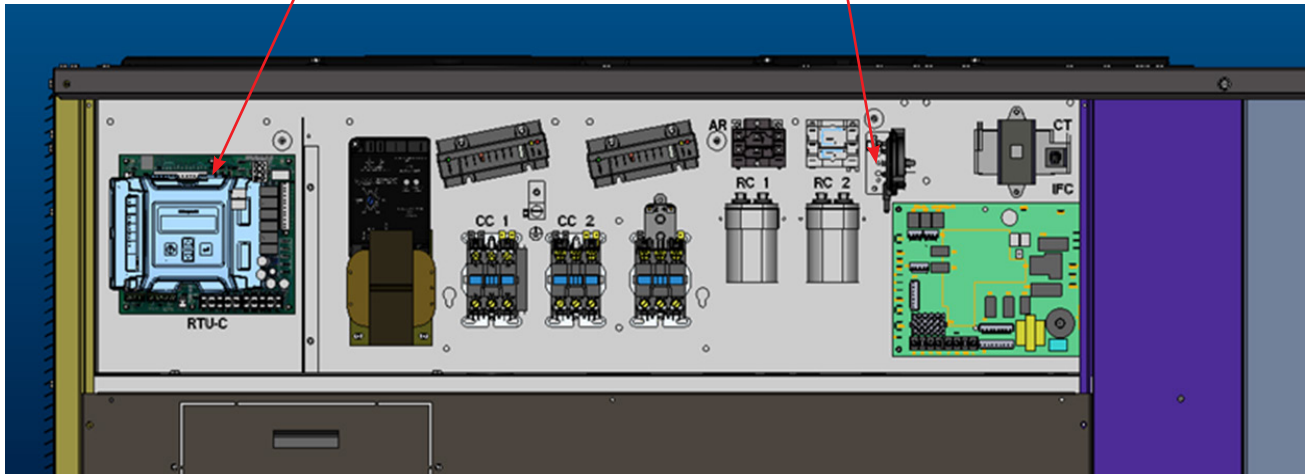

FIGURE 8 W7220 JADE economizer controller field-mounted in control compartment of HVAC unit

Unit control board factory-mounted in control compartment of HVAC unit.



DIRECT MOUNT ECONOMIZER OPERATION

GENERAL

This accessory economizer package is designed to save energy costs by using outdoor air for cooling and ventilation in place of mechanical cooling whenever possible. The economizer continuously monitors indoor and outdoor air conditions and compares them to a user-selected setpoint to determine if free cooling is available. The economizer utilizes a fully-modulating damper actuator, which will control the outside air damper and return air damper in order to maintain a factory-set mixed air/discharge air temperature.

ACCESSORIES

(-)XRX-AV04 - Dual Enthalpy Upgrade Kit

For maximum energy savings, this upgrade kit will allow the economizer to compare the outdoor air enthalpy to the return air enthalpy, instead of a user-selected setpoint to determine if "free cooling" is available. This Sylk Bus Sensor is a combination temperature and humidity sensor which is powered by and communicates on the two-wire communication bus of the W7220 economizer logic module. All OA (Outside Air) and RA (Return Air) sensors are the same. Sensor must be set for the type of sensing using the three DIP switches located on the sensor during INSTALLATION.

Dip Switch Setting	C1	C2	C3
Return Air Enthalpy Sensor	ON	OFF	OFF
Outside Air Enthalpy Sensor	OFF	OFF	OFF

(-)XRX-AR02 - Wall-Mounted Carbon Dioxide Sensor

For installations requiring Demand Control Ventilation (DCV) based upon indoor air levels of carbon dioxide (CO₂). When the unit supply fan is running, the CO₂ sensor modulates the outside air damper to maintain a user-selected CO₂ level inside the occupied space.

Energy savings are achieved by not bringing in excessive amounts of outdoor air when the indoor air conditions are suitable. Energy savings can be substantial on buildings with highly variable occupancy rates.

NOTE: The (-)XRX-AR02 has a default setting of a 2-10 Vdc output for a 500-1500 ppm CO₂ input. The W7220 economizer controller requires jumper pins on the sensor to be relocated to provide a 0-2000 ppm input.

SW1	SW1	AN (ppm)	Relay (ppm)
ON	ON	0 to 1000	1000
OFF	ON	0 to 2000 ←	1200
ON	OFF	500 to 1500	800
OFF	OFF	500 to 2000	1200

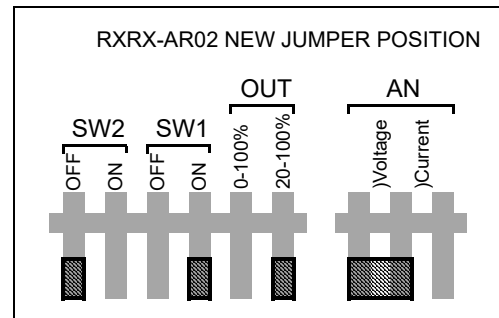

Wiring Schematic for (-)XRX-AR02

Note: Black & brown wire common.

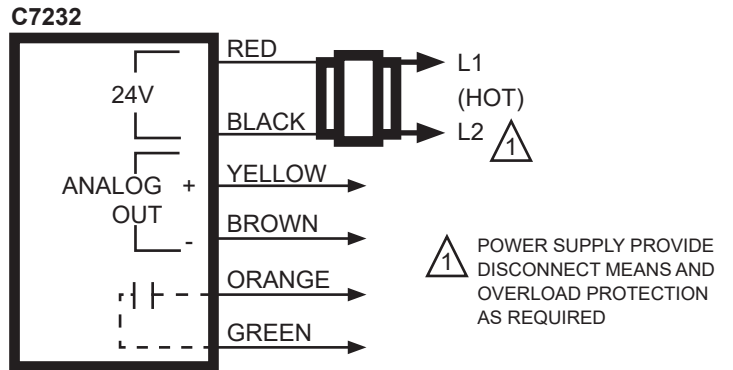

Power Exhaust Kit

For installations requiring more space static pressure relief than can be obtained with the standard barometric relief damper included with the economizer, a power exhaust kit can be added.

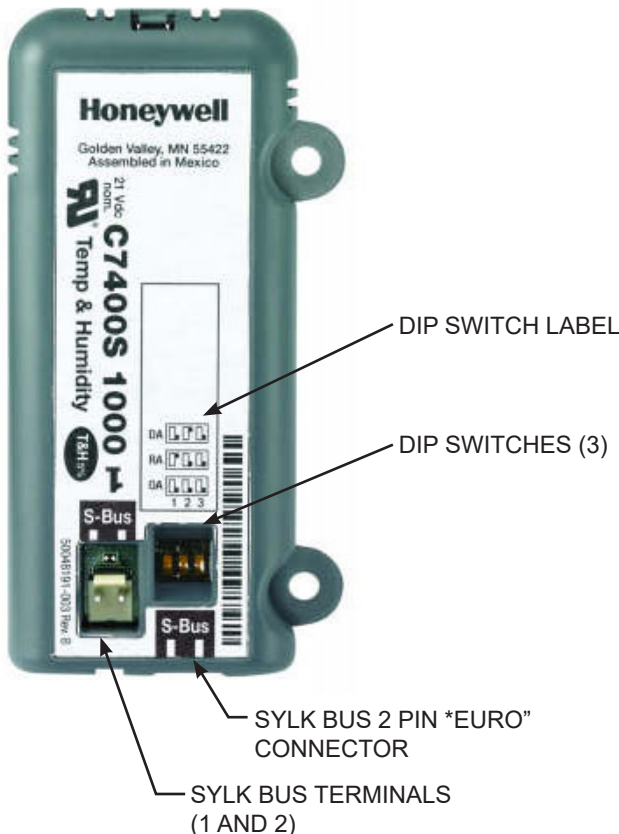

ADJUSTMENT METHOD

The user interface consists of an LCD display and a 4-button keypad on the front of the Economizer module. The LCD is a 16 character by 2 line dot matrix display.

Power Up Cycle

All setpoints and advanced settings are restored after any power loss (a power loss is assumed if voltage falls below 18 Vac). Normal operation is restored when power returns above 18 Vac.

Initial Menu Display

On initial startup, **Honeywell** displays on the first line and **Economizer W7220** on the second line. After a brief pause, the revision of the software appears on the first line (second line is blank). It then displays **W7220 ↓** on the first line and **STATUS** on the second line.

Key pad

The four navigation buttons illustrated in Figure 9 are used to scroll through the menus and menu items, select menu items, and to change parameter and configuration settings.

Using the Key pad with Menus

To use the keypad when working with menus:

- Press the ▲ button to move to the previous menu.
- Press the ▼ button to move to the next menu.
- Press the ↵ button (Enter) to display the first item in the currently displayed menu.
- Press the ↑ button (Menu up) to exit a menu's item and return to the list of menus.

Using the Key pad with Settings and Parameters

To use the keypad when working with Setpoints, System and Advanced Settings, Checkout tests, and Alarms:

- Navigate to the desired menu.
- Press the ↵ button (Enter) to display the first item in the currently displayed menu.
- Use the ▲ and ▼ buttons to scroll to the desired parameter.
- Press the ↵ button (Enter) to display the value of the currently displayed item.
- Press the ▲ button to increase (change) the displayed parameter value.^a
- Press the ▼ button to decrease (change) the displayed parameter value.^a
- Press the ↵ button to accept the displayed value and store it in non-volatile RAM.
- When the value is accepted, **CHANGE STORED** is displayed on the LCD.
- Press the ↵ button (Enter) to return to the current menu parameter.
- Press the ↑ button (MenuUp/Exit) to return to the previous menu.



FIGURE 9

Time-out and Screensaver

When no buttons have been pressed for 10 minutes, the LCD displays a screen saver, which cycles through the Status items. Each Status items displays in turn and cycles to the next item after 5 seconds.

SETUP AND CONFIGURATION

Before being placed into service, the JADE™ Economizer module must be setup and configured for the installed system. Use the System Setup menu, the Advanced Setup menu (if necessary), and the Setpoints menu to accomplish this.

Menu Structure

The following tables illustrate the complete hierarchy of menus and parameters for the JADE™ Economizer system.

The Menus in display order are:

- STATUS
- SETPOINTS
- SYSTEM SETUP
- ADVANCED SETUP
- CHECKOUT
- ALARMS

IMPORTANT

Your menu parameters may be different depending on your configuration. For example if you do not have a DCV (CO₂) sensor, then none of the DCV parameters appear.

^a When values are displayed, pressing and holding the ▲ or ▼ button causes the display to automatically increment.

STATUS MENU

Parameter	Parameter Default Value	Parameter Range and Increment ^a	Notes
ECON AVAIL	NO	YES/NO	YES = economizing available; the system can use Out door Air for free cooling when required.
ECONOMIZING	NO	YES/NO	YES = Outdoor Air being used for 1st stage cooling.
OCCUPIED	NO	YES/NO	YES = 24 Vac OCC signal received from space thermostat in put. NO = 0 Vac on terminal OCC.
HEAT PUMP	COOL	COO/HEAT	Displays COOL or HEAT when SYSTEM is set to heat pump (nonconventional)
COOL Y1-IN	OFF	ON/OFF	Y1-I signal from space thermostat input for cooling stage 1 or heat pump heating stage 1. ON = 24 Vac on terminal Y1-I OFF = 0 Vac on terminal Y1-I
COOL Y1-OUT	OFF	ON/OFF	Cool Stage 1 Relay Output to stage 1 mechanical cooling (Y1-OUT terminal).
COOL Y2-IN	OFF	ON/OFF	Y2-I signal from space thermostat input for second stage cooling or heat pump heating stage 2. ON = 24 Vac on terminal Y2-I OFF = 0 Vac on terminal Y2-I
COOL Y2-OUT	OFF	ON/OFF	Cool Stage 2 Relay Output to mechanical cooling (Y2-OUT terminal).
MA TEMP	___°F	-40 to 150°F	Displays value of measured mixed air from MAT sensor. Displays - if not connected, short, or out-of-range.
DA TEMP	___°F	-40 to 150°F	Displays when Discharge Air Syk Bus sensor is connected and displays measured discharge air temperature. Displays -°F if sensor sends in valid value, if not connected, short or out-of-range.
OA TEMP	___°F	-40 to 140°F	Displays measured value of out door air temperature. Displays -°F if sensor sends in valid value, if not connected, short or out-of-range.
OA HUM	__%	0 to 100%	Displays measured value of out door humidity. Displays -% if not connected, short, or out-of-range.
RA TEMP	___°F	0 to 140°F	If field installed Dual Enthalpy sensor is connected, displays measured value of return air temperature. Displays -°F if sensor sends in valid value, if not connected, short or out-of-range.
RA HUM	__%	0 to 100%	If field installed Dual Enthalpy sensor is connected, displays measured value of return air humidity. Displays -% if sensor sends in valid value, if not connected, short or out-of-range.
IN CO2	___ppm	"0 to 2000 (3500) ppm"	If field installed CO2 sensor is connected, displays value of measured CO2. In valid if not connected, short or out-of-range. May be adjusted in Advanced menu by Zero off set and Span.
DCV STATUS	n/a	n/a	If field in stalled CO2 sensor is connected, displays ON if above setpoint and OFF if be low setpoint.
DAMPER OUT	__%	0 to 100%	Displays output position to the damper actuator. When used with Honeywell communicating actuator the damper out is in XX.X%
ACT POS.	n/a	0 to 100%	Displays actual position of actuator.
ACT COUNT	n/a	1 to 65,535	Displays number of times actuator has cycled. 1 Cycle equals 180° of movement in any direction.
ACTUATOR	n/a	OK/Alarm	Displays Error on ALARM MENU if voltage or torque is below actuator range.
EXH1 OUT	OFF	ON/OFF	Output of EXH1 terminal. - ON = relay closed; OFF = relay open.
EXH2 OUT	OFF	ON/OFF	Output of AUX1 O terminal; displays only if AUX1 O = EXH2
ERV	OFF	ON/OFF	Output of AUX1 O terminal; displays only if AUX1 O = ERV
"MECH COOL ON HEAT STGS ON"	0	0, 1, or 2	Displays stage of mechanical cooling that is active. Displays the stage of heat pump heating that is active.
FAN SPEED	n/a	LOW/HIGH	Displays speed of fan on a 2-speed fan unit
W (HEAT IN)	n/a	ON/OFF	Displays status of heat on a 2-speed fan unit.

SETPOINTS MENU

Parameter	Parameter Default Value	Parameter Range and Increement ^a	Notes
MAT SET	53°F	38 to 70°F; incremented by 1	Setpoint determines where the economizer will modulate the OA damper to maintain the mixed air temperature.
LOW T LOCK	32°F	-45 to 80°F; incremented by 1	Setpoint determines outdoor temperature when the mechanical cooling cannot be turned on. Commonly referred to as the Compressor lockout.
DRYBLB SET	63°F	48 to 80°F; incremented by 1	Setpoint determines where the economizer will assume outdoor air temperature is good for free cooling; e.g.; at 63°F unit will economizer at 62°F and below and not economize at 64°F and above. There is a 2°F deadband.
ENTH CURVE	ES3	ES1, ES2, ES3, ES3, or ES5	Does not display if a field installed Dual Enthalpy kit is connected. Enthalpy boundary "curves" for economizing using single enthalpy comparison between outdoor air enthalpy and setpoint.
DCV SET	1100 ppm	500 to 2000 ppm increment by 100	Displays ONLY if field installed CO2 sensor is connected. Setpoint for Demand Control Ventilation of space. Above the setpoint, the OA dampers will modulate open to bring in additional OA to maintain a space ppm level below the setpoint.
MIN POS	2.8 V	2 to 10 Vdc	Displays ONLY if a CO2 sensor is NOT connected.
			With 2-speed fan units MIN POS L (low speed fan) and MIN POS H (high speed fan) settings are required. Default for MIN POS L is 3.2V and MIN POS H is 2.8V
VENTMAX	2.8 V	2 to 10 Vdc	Displays only if a field installed CO2 sensor is connected. Used for Vbz (ventilation max cfm) setpoint. VENTMAX is the same setting as MIN POS would be if you did not have the CO2 sensor.
		100 to 9990 cfm increment by 10	If OA, MA, RA and CO2 sensors are connected and DCV CAL ENABLE is set to AUTO mode, the OA dampers are controlled by CFM and displays from 100 to 9990 cfm.
		2 to 10 Vdc	With 2-speed fan units VENTMAX L (low speed fan) and VENTMAX H (high speed fan) settings are required. Default for VENTMAX L is 3.2V and VENTMAX H is 2.8V.
VENTMIN	2.25 V	2 to 10 Vdc	Dis plays only if field in stalled CO2 sen sor is con nected. Used for Va (ven ti la tion min cfm) setpoint. This is the ven ti la tion re quire ment for less than max i mum oc cu pancy of the space.
		100 to 9990 cfm increment by 10	If OA, MA, RA and CO2 sen sors are con nected and DCV CAL EN ABLE is set to AUTO mode, the OA damp ers are con trolled by CFM and dis plays from 100 to 9990 cfm.
		2 to 10 Vdc	With 2-speed fan units VENTMIN L (low speed fan) and VENTMIN H (high speed fan) set tings are re quired. De fault for VENTMIN L is 2.5V and VENTMIN H is 2.25V.
ERV OAT SP	32°F	0 to 50°F; increment by 1	Only when AUX1 O = ERV
EXH1 SET	50%	0 to 100%; increment by 1	Setpoint for OA damper position when exhaust fan 1 is powered by the economizer. With 2-speed fan units Exh1 L (low speed fan) and Exh1 H (high speed fan) settings are required. Default for Exh1 L is 65% and Exh1 H is 50%.
EXH2 SET	75%	0 to 100%; increment by 1	Setpoint for OA damper position when exhaust fan 2 is powered by the economizer. Only used when AUX1 O is set to EHX2. With 2-speed fan units Exh2 L (low speed fan) and Exh2 H (high speed fan) settings are required. Default for Exh2 L is 80% and Exh2 H is 75%.

SYSTEM SETUP MENU

Parameter	Parameter Default Value	Parameter Range and Increment ^a	Notes
INSTALL	01/01/2011		Display order = MM/DD/YY. Setting order = DD, MM, then YY.
UNITS DEG	°F	°F or °C	Sets economizer controller in degrees Fahrenheit or Celsius.
EQUIPMENT	HP O/B	CONV HP O/B	HP O/B = Enables Heat Pump mode. Use AUX2 I for Heat Pump ("B" – signal) input from thermostat. CONV = conventional.
AUX2 I	HP(B)	Shutdown (SD) Heat (W1) HP(O) HP(B)	In HP O/B mode: HP(O) = energize heat pump on Cool; HP(B) = energize heat pump on Heat. In CONV mode: SD = Enables configuration of shutdown; W = Informs controller that system is in heating mode. NOTE: If using 2-speed fan mode, you must program CONV mode for W. Shutdown is not available in the two speed fan mode.
FAN TYPE	1 speed	1 speed/ 2speed	Sets economizer controller for operation of 1 speed or 2 speed supply fan NOTE: 2-speed fan option also needs Heat (W1) programmed in AUX 2 In.
FAN CFM	5000cfm	100 to 15000 cfm; increment by 100	This is the airflow capacity of the rooftop unit or air handler. The value is found in the unit I&O manual or specification sheet. The cfm of the indoor fan is only used with the DCVCAL ENA parameter set in the AUTO mode.
AUX1 OUT	EXH2	NONE ERV EXH2 SYS	<ul style="list-style-type: none"> • NONE = not configured (output is not used) • ERV= Energy Recovery Ventilator • EXH2 = second damper position relay closure for second exhaust fan. • SYS = use output as an alarm signal
OCC	INPUT	INPUT or ALWAYS	The indoor fan "G" or "ON" Signal. Can also be used with a setback thermostat with occupancy out (24 Vac), where the 24 Vac is input "INPUT" to the OCC terminal. If no occupancy output from the thermostat then change program to "ALWAYS".
FACTORY DEFAULT	NO	NO or YES	Resets all set points to factory defaults when set to YES. LCD will briefly flash YES and change to NO but all parameters will change to factory default values.

ADVANCE SETUP MENU

Parameter	Parameter Default Value	Parameter Range and Increment ^a	Notes
MA LO SET	45°F	35 to 55°F increment by 1°	Temp to activate Freeze Protection (close damper and alarm if temp falls below setup value)
FREEZE POS	CLO	CLO MIN	Damper position when freeze protection is active (closed or MIN POS).
CO2 ZERO	0 ppm	0 to 500 ppm increment by 10	Displays only if field installed CO2 sensor is connected. CO2 ppm level to match CO2 sensor start level.
CO2 SPAN	2000 ppm	1000 to 3000 ppm; increment by 50	Displays only if field installed CO2 sensor is connected. CO2 ppm span to match CO2 sensor.
STG3 DLY	2.0h	0 min, 5 min, 15 min, then 15 min intervals. Up to 4h or OFF	Delay after stage 2 for cool has been active. Turns on 2nd stage of cooling when economizer is 1st stage and mechanical cooling is 2nd stage. Allows three stages of cooling, 1 economizer and 2 mechanical. OFF = no Stage 3 cooling.
SD DMPR POS	CLO	CLO OPN	Indicates shutdown signal from space thermostat. When controller receives 24 Vac input on the SD terminal in conventional mode, the OA damper will open if programmed for OPN and OA damper will close if programmed for CLO. All other controls, e.g., Y1-O, Y2-O, EXH1, etc. will shut off.
DCVCAL ENA	MAN	MAN (manual) AUTO	Displays only if all sensors (RA, OA, MA and CO2) are connected. Turns on the DCV automatic control of the dampers. Resets ventilation based on the RA, OA and MA sensor conditions. This operation is not operable with a 2-speed fan unit.
MAT T CAL	0.0 F°	+/-2.5F°	Allows for the operator to adjust for an out of calibration mixed air temperature sensor.
OAS T CAL	0.0F°	+/-2.5F°	Allows for the operator to adjust for an out of calibration outdoor air temperature sensor.
OAS H CAL	0% RH	+/-10% RH	Allows for the operator to adjust for an out of calibration outdoor air humidity sensor.
RA T CAL	0.0F°	+/-2.5F°	If field installed Dual Enthalpy sensor is connected, allows for the operator to adjust for an out of calibration temperature sensor.
RA H CAL	0% RH	+/-10% RH	If field installed Dual Enthalpy sensor is connected, allows for the operator to adjust for an out of calibration humidity sensor.
DA T CAL	0.0F°	+/-2.5F°	Allows for the operator to adjust for an out of calibration Discharge Air Syk Bus temperature sensor.
2SP FAN DELAY	5 Minutes	0 to 20 minutes in 1 minute increments.	When in economizing mode this is the delay for the high speed fan to try to satisfy the call for second stage cooling before the first stage mechanical cooling is enabled.

CHECKOUT MENU

Parameter	Parameter Default Value	Parameter Range and Increment ^a	Notes
DAMPER VMIN-HS	n/a	n/a	Positions damper to VMIN position
DAMPER VMAX-HS	n/a	n/a	Positions damper to VMAX position.
DAMPER VMAX-LS			With 2-speed fan units the damper will position to VMAX low speed fan.
DAMPER OPEN	n/a	n/a	Positions outside air damper to the full open position.
DAMPER CLOSE	n/a	n/a	Positions outside air damper to the fully closed position.
CONNECT Y1-O	n/a	n/a	Closes the Y1-O relay (Y1-O); energizes 1st stage compressor.
CONNECT Y2-O	n/a	n/a	Closes the Y2-O relay (Y2-O); energizes 2nd stage compressor.
CONNECT EXH1	n/a	n/a	Closes the power exhaust fan 1 relay (EXH1)
CONNECT EXH2	n/a	n/a	Energizes the EXH2 output. The EXH2-O can be replaced by: <ul style="list-style-type: none"> • ERV • EXH2 • SYS • AUX1 O Based on AUX1 O switch settings or is not available if AUX1 O is set to NONE

Check out Tests

Use the Checkout menu to test the damper operation and any configured outputs. Only items that are configured are shown in the Checkout menu.

To perform a Checkout test:

1. Scroll to the desired test in the Checkout menu using the ▲ and ▼ buttons.
2. Press the ← button to select the item.
3. RUN? appears on the display.
4. Press the ← button to start the test.
5. The unit pauses and then displays **TEST RUNNING**.
6. Press the button ↑ (Menu up) to end the test (e.g. turn off the relay). Test stops automatically after 10 minutes without a command or mode change, and will resume normal operation.

The checkout tests can all be performed at the time of installation or any time during the operation of the system as a test that the system is operable.

NOTE: Be sure to allow for enough time for compressor startup and shutdown between checkout tests so that you do not short-cycle the compressors and damage them from extreme short-cycling.

ALARM MENU

Parameter	Parameter Default Value	Parameter Range and Increment ^a	Notes
MA T SENS ERR	n/a	n/a	Alarms display only when they are active. The menu title "ALARMS (_)" includes the number of active alarms in parenthesis ().
CO2 SENS ERR	n/a	n/a	
OAT SENS ERR	n/a	n/a	
DA ENTHL ERR	n/a	n/a	
SYS ALARM	n/a	n/a	When AUX1 O is set to SYS and there is any alarm (e.g., failed sensors, etc.), the AUX1 O terminal has 24 Vac out.
ACT UNDER V	n/a	n/a	Voltage received by Actuator is above expected range
ACT OVER V	n/a	n/a	Voltage received by Actuator is below expected range
ACT STALLED	n/a	n/a	Actuator stopped before achieving commanded position

Alarms

The Economizer module provides alarm messages that display on the 2-line LCD.

NOTE: Upon power up, the module waits 60 minutes before checking for alarms. This allows time for all the configured devices (e.g. sensors, actuator) to become operational. The exception is the MA sensor which will alarm immediately.

If one or more alarms are present and there has been no keypad activity for at least 5 minutes, the Alarms menu displays and cycles through the active alarms. You can also navigate to the Alarms menu at any time.

Clearing Alarms

Once the alarm has been identified and the cause has been removed (e.g. replaced faulty sensor), the alarm can be cleared from the display. To clear an alarm, perform the following:

1. Navigate to the desired alarm.
2. Press the ← button.
3. **ERASE?** displays.
4. Press the ← button.
5. **ALARM ERASED** displays.
6. Press the button ↑ (MenuUp/Exit) to complete the action and return to the previous menu.

NOTE: If an alarm still exists after you clear it, it redisplay within 5 seconds.

TYPICAL ADJUSTMENTS

1. Economizer ENTH CURVE Setpoint
 - a. Only the coolest, driest outside air is used for economizer operation when parameter "ES5" is selected on the SETPOINT MENU. Select parameter "ES1" on the SETPOINT MENU for the greatest energy savings.
 - b. Adjustments are ES1, ES2, ES3, ES4, ES5.
 - c. "ES3" is the default setting.
 - d. Economizer ENTH CURVE Setpoint can be adjusted at any time and may need adjustment for jobsite conditions.

- e. Single enthalpy strategy: If outdoor air enthalpy is lower than the ENTH CURVE setpoint, then free cooling is available.
- f. Dual enthalpy strategy: ENTH CURVE Setpoint is not used. If outdoor air enthalpy is lower than return air enthalpy, then free cooling is available. There is also a high limit boundary for dual enthalpy. The high limit boundary is "ES1" when there are no stages of mechanical cooling energized and "HL" when a compressor stage is energized.

JADE™ ECONOMIZER MODULE

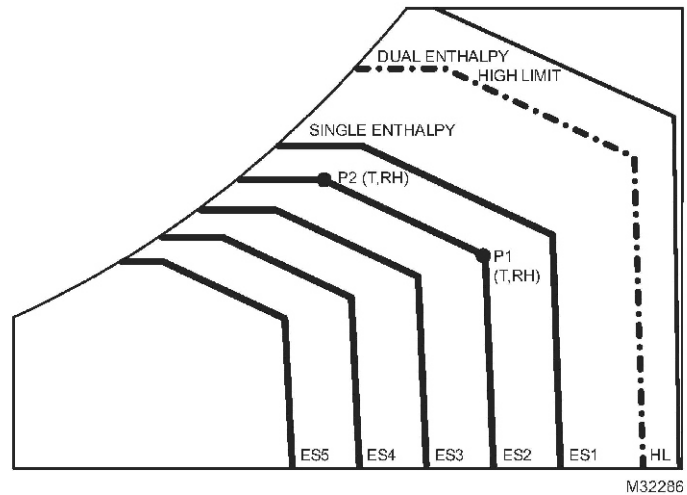
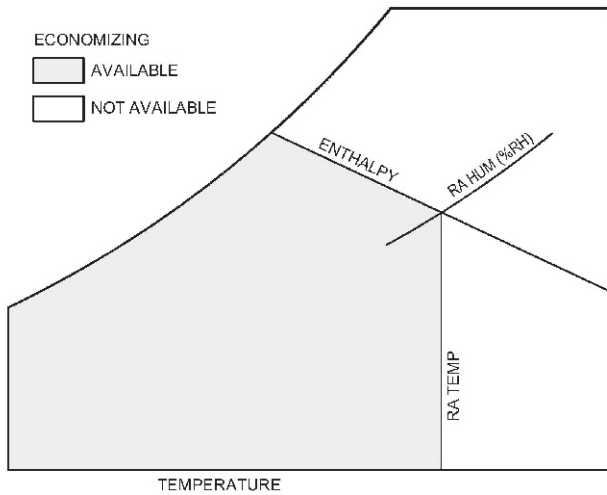

Single Enthalpy and Dual Enthalpy High Limit Curves							
Enthalpy Curve	Temp. Dry-Bulb (°F)	Temp. Dewpoint (°F)	Enthalpy (btu/lb/da)	Point P1		Point P2	
				Temp. °F	Humidity %RH	Temp. °F	Humidity %RH
ES1	80.0	60.0	28.0	80.0	36.8	66.3	80.1
ES2	75.0	57.0	26.0	75.0	39.6	63.3	80.0
ES3	70.0	54.0	24.0	70.0	42.3	59.7	81.4
ES4	65.0	51.0	22.0	65.0	44.8	55.7	84.2
ES5	60.0	48.0	20.0	60.0	46.9	51.3	88.5
HL	86.0	66.0	32.4	86.0	38.9	72.4	80.3

2. **EXH1 SET** - Adjustments for (optional) power exhaust.
 - a. The outside air damper position at which the power exhaust fan(s) will engage.
 - b. With 2-speed indoor fan units EXH1 L (low speed fan) and EXH1 H (high speed fan) settings are required.
 - c. Default for EXH1 L is 65% and EXH1 H is 50%.
 - d. After the outside air damper output command DAMPER OUT (not ACT POS.) reaches the power exhaust setpoint, the power exhaust output EXH1 is energized after a 45 second delay.
 - e. Range of adjustment is from 0-100% outside air.

3. **EXH2 SET** - Adjustments for (optional) 2 speed power exhaust.
 - a. The outside air damper position at which the 2nd speed of the power exhaust fan(s) will engage.
 - b. With 2-speed indoor fan units EXH2 L (low speed fan) and EXH2 H (high speed fan) settings are required.
 - c. Default for EXH2 L is 80% and EXH2 H is 75%.
 - d. After the outside air damper output command DAMPER OUT (not ACT POS.) reaches the power exhaust setpoint, the power exhaust output EXH2 is energized after a 45 second delay to allow the damper to reach the appropriate position.
 - e. Range of adjustment is from 0-100% outside air.

4. **MIN POS** - Outside Air Damper minimum position
 - a. Displays ONLY if a CO2 sensor is NOT connected. With 2-speed fan units MIN POS L (low speed fan) and MIN POS H (high speed fan) settings are required. Default for MIN POS L is 3.2V and MIN POS H is 2.8V.
 - b. Adjust MIN POS to allow the minimum amount of outdoor air, as required by local codes, to enter the building.
 - c. Range of adjustment is from 0-100% (2-10V); in most applications MIN POS is adjusted to allow 10% to 25% outside air to enter the system.
 - d. MIN POS can be adjusted at any time.
 - e. Whenever the "G" (supply fan) signal is present, the damper will open to this minimum position unless the mixed air sensor falls below the MA LO SET (Freeze Protect Mode Setpoint).
5. **VENTMAX** - Demand Control Ventilation (DCV) Maximum Setpoint
 - a. Displays only if a CO2 sensor is connected.
 - b. VENTMAX allows the installer to limit the amount of outdoor airflow into the building when DCV overrides the mixed air temperature sensor setpoint. It is normally equal to the minimum amount of outdoor air under maximum occupancy, as required by local codes, to enter the building.
 - c. VENTMAX can be adjusted at any time.
6. **VENTMIN** - Demand Control Ventilation (DCV) Setpoint
 - a. Displays only if a CO2 sensor is connected.
 - b. Is the ventilation requirement for less than maximum occupancy of the space.
 - c. Compatible CO2 sensors will have a 2-10Vdc output for a 0-2000 ppm CO2 input.
 - d. DCV modulates the outdoor damper between the VENTMIN and VENTMAX settings to provide ventilation based on occupancy. The carbon dioxide (CO2) sensor is used to indirectly monitor occupancy level.
 - e. No cooling signal (e.g.Y1, Y2) is required for DCV to override the outdoor air damper when ventilation requires outdoor air.
 - f. The controller must receive a "G" (supply fan) signal to open the damper.
 - g. Range of adjustment is from 2 Volts to 10 Volts.
 - h. VENTMIN can be adjusted at any time.
 - i. The controller compares the CO2 sensor input to VENT MIN to determine the damper minimum position.
 - i. If the actual CO2 level is below the setpoint, then the damper minimum position is determined by the damper minimum position (VENTMIN) setting.
 - ii. If the actual CO2 level rises above the setpoint, then the damper minimum position is overridden proportionally more open up to the VENTMAX setting.
 - iii. If the mixed air temperature drops below 45°F (MA LO SET - Freeze Protect Mode Setpoint), the DCV input will be overridden and the damper may not open.
 - j. Ensure proper polarity of the sensor wires when connecting to the economizer controller. Incorrect polarity negates the sensor signal.

NORMAL OPERATION

1. **Fan Only (G)**
 - a. Damper will go to minimum position (in 90 seconds or less) whenever the "G" (supply fan) signal is present.
 - b. When "G" signal is removed, the outside air damper closes against blade seals for tight shutoff of outside air.
 - c. If the mixed air temperature drops below 45°F (MA LO SET Setpoint), then the control will override the minimum position setting and will modulate the outside air damper closed.
2. **Call for First Stage of Cooling (Y1)**
 - a. Economizer Unavailable (warm outdoor air): Closes the Y1-O relay (Y1-O) which energizes 1st stage compressor.
 - b. Economizer Available (free cooling): The controller tries to maintain a mixed air temperature of 53°F ± 5 (MAT SET Setpoint) by modulating the outside air damper position.
3. **Call for Second Stage of Cooling (Y2)**
 - a. Economizer Unavailable (warm outdoor air): Closes the Y2-O relay (Y2-O) which energizes 2nd stage compressor.
 - b. Economizer Available (free cooling): Closes the Y1-O relay (Y1-O) which energizes 1st stage compressor. The controller tries to maintain a mixed air temperature of 53°F ± 5 (MAT SET Setpoint) by modulating the outside air damper position. After a time period of 2 hours of simultaneous economizer operation and first stage compressor operation, the economizer closes the Y2-O relay (Y2-O) which energizes 2nd stage compressor.
4. **Call for Heat**
 - a. Standard Air Conditioner with electric or gas heat.(W1 & W2)
 - i. The Thermostat controls the stages of heating directly.
 - ii. If the control detects that the supply fan is on (through its "G" input), then the control will open the damper to minimum position.
 - iii. If the mixed air temperature drops below 45°F (MA LO SET Setpoint), then the control will override the minimum position setting and will modulate the outdoor damper closed.
 - b. Heat Pump Operation (B)
 - i. The "B" signal from the Thermostat allows operation of the compressors to provide heating without delay.
 - ii. If the control detects that the supply fan is on (through its "G" input), then the control can open the damper to minimum position.
 - iii. If the mixed air temperature drops below 45°F (MA LO SET Setpoint), then the control will override the minimum position setting and will modulate the outdoor damper closed.

NOTES

1. This economizer requires a two-stage thermostat.
2. When diagnosing the system, the best results are obtained by first putting the fan setting on the Thermostat to the "Continuous Fan" mode.
3. Operation of the optional power exhaust only depends upon the supply fan running and the damper position (it is possible to set the minimum position high enough to engage the power exhaust in the heating mode).
4. Upon loss of power to the unit or economizer, the outside air damper will spring close shut in about 5 seconds.
5. The mist eliminator (Permanent Outdoor Air Filter) is of aluminum mesh construction and should be cleaned by flushing regularly with warm soapy water. The replacement mist eliminator size is listed on the first page of these instructions.
6. Compressor Time Delays, Compressor Interstage Delays are not provided by the economizer controller.

Table of Inputs and Output Response with and without a CO2 Sensor (DCV)								
Inputs to Controller						Outputs from Controller		
DCV	Free Cooling Available?	Y1-I	Y2-I	AUX2-I	FAN	Y1-O	Y2-O	OA Damper Position
None	NO	OFF	OFF	OFF	OFF	OFF	OFF	CLOSED
		OFF	OFF	OFF	ON	OFF	OFF	MIN POS
		ON	OFF	OFF	ON	ON	OFF	MIN POS
		ON	ON	OFF	ON	ON	ON	MIN POS
		ON	OFF	ON ^d	ON	ON	OFF	MIN POS
		ON	ON	ON ^d	ON	ON	ON	MIN POS
	YES	OFF	OFF	OFF	ON	OFF	OFF	MIN POS
		ON	OFF	OFF	ON	OFF	OFF	MIN POS to 100%
		ON	ON	OFF	ON	ON	OFF ^b	MIN POS to 100%
		ON	OFF	ON ^d	ON	ON	OFF	MIN POS
Below Setpoint	NO	OFF	OFF	OFF	ON	OFF	OFF	VENTMIN
		ON	OFF	OFF	ON	ON	OFF	VENTMIN
		ON	ON	OFF	ON	ON	ON	VENTMIN
		ON	OFF	ON ^d	ON	ON	OFF	VENTMIN
		ON	ON	ON ^d	ON	ON	ON	VENTMIN
	YES	OFF	OFF	OFF	ON	OFF	OFF	VENTMIN
		ON	OFF	OFF	ON	OFF	OFF	VENTMIN to 100%
		ON	ON	OFF	ON	ON	OFF ^b	VENTMIN to 100%
		ON	OFF	ON ^d	ON	ON	OFF	VENTMIN
		ON	ON	ON ^d	ON	ON	ON	VENTMIN
Above Setpoint	NO	OFF	OFF	OFF	ON ^c	OFF	OFF	VENTMIN to VENTMAX
		ON	OFF	OFF	ON	ON	OFF	VENTMIN to VENTMAX
		ON	ON	OFF	ON	ON	ON	VENTMIN to VENTMAX
		ON	OFF	ON ^d	ON	ON	OFF	VENTMIN to VENTMAX
		ON	ON	ON ^d	ON	ON	ON	VENTMIN to VENTMAX
	YES	OFF	OFF	OFF	ON ^c	OFF	OFF	VENTMIN to VENTMAX
		ON	OFF	OFF	ON	OFF	OFF	VENTMIN to 100%
		ON	ON	OFF	ON	ON	OFF ^b	VENTMIN to 100%
		ON	OFF	ON ^d	ON	ON	OFF	VENTMIN to VENTMAX
		ON	ON	ON ^d	ON	ON	ON	VENTMIN to VENTMAX

^B With STG3 DLY in ADVANCED SETUP MENU at 2.0 hours, the 2nd stage of mechanical cooling Y2-O can be energized after a 2 hour delay if the call for Y1-I and Y2-I have not been satisfied.

^C The CO2 sensor has a relay output that is active when the CO2 level is above 1200ppm that can be used to energize the indoor fan through the "G" thermostat input of the unit even if there is not a call for fan, cooling or heating by the room thermostat. Additional field wiring is required to enable this option.

^D AUX2-I is used only on heat pump models to indicate unit is in heat pump (heating) mode.

Table of Inputs and Output Response with and without a CO2 Sensor (DCV) for Unoccupied Mode								
Inputs to Controller						Outputs from Controller		
DCV	Free Cooling Available?	Y1-I	Y2-I	AUX2-I	FAN	Y1-O	Y2-O	OA Damper Position (Unoccupied)*
None	NO	OFF	OFF	OFF	OFF	OFF	OFF	CLOSED
		OFF	OFF	OFF	ON	OFF	OFF	CLOSED
		ON	OFF	OFF	ON	ON	OFF	CLOSED
		ON	ON	OFF	ON	ON	ON	CLOSED
		ON	OFF	ON ^d	ON	ON	OFF	CLOSED
		ON	ON	ON ^d	ON	ON	ON	CLOSED
	YES	OFF	OFF	OFF	ON	OFF	OFF	CLOSED
		ON	OFF	OFF	ON	OFF	OFF	CLOSED to 100%
		ON	ON	OFF	ON	ON	OFF ^b	CLOSED to 100%
		ON	OFF	ON ^d	ON	ON	OFF	CLOSED
Below Setpoint	NO	OFF	OFF	OFF	ON	OFF	OFF	CLOSED
		ON	OFF	OFF	ON	ON	OFF	CLOSED
		ON	ON	OFF	ON	ON	ON	CLOSED
		ON	OFF	ON ^d	ON	ON	OFF	CLOSED
		ON	ON	ON ^d	ON	ON	ON	CLOSED
	YES	OFF	OFF	OFF	ON	OFF	OFF	CLOSED
		ON	OFF	OFF	ON	OFF	OFF	CLOSED to 100%
		ON	ON	OFF	ON	ON	OFF ^b	CLOSED to 100%
		ON	OFF	ON ^d	ON	ON	OFF	CLOSED
		ON	ON	ON ^d	ON	ON	ON	CLOSED
Above Setpoint	NO	OFF	OFF	OFF	ON ^e	OFF	OFF	CLOSED
		ON	OFF	OFF	ON	ON	OFF	CLOSED
		ON	ON	OFF	ON	ON	ON	CLOSED
		ON	OFF	ON ^d	ON	ON	OFF	CLOSED
		ON	ON	ON ^d	ON	ON	ON	CLOSED
	YES	OFF	OFF	OFF	ON ^e	OFF	OFF	CLOSED
		ON	OFF	OFF	ON	OFF	OFF	CLOSED to 100%
		ON	ON	OFF	ON	ON	OFF ^b	CLOSED to 100%
		ON	OFF	ON ^d	ON	ON	OFF	CLOSED
		ON	ON	ON ^d	ON	ON	ON	CLOSED

^e Unoccupied Mode is only available by field wiring a normally open (NO) relay in the "G" signal wiring between the unit and economizer. A thermostat with an occupied output is required which energizes the relay when the space is occupied. The relay interrupts the 24 volt "G" signal from the unit indoor fan when the space is unoccupied.

Mixed Air / Discharge Air Temperature vs. Resistance

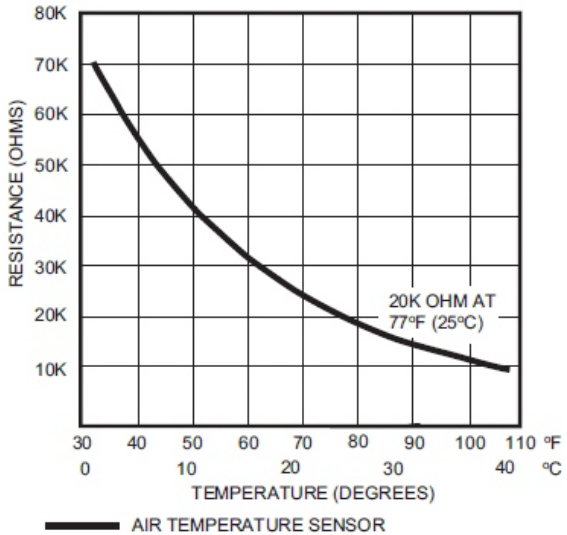

M11620

