



REFRIGERANT **R410A**  
**INVERTER**

AIR CONDITIONER

**Multi: 5 rooms type**

# DESIGN & TECHNICAL MANUAL

---

---

INDOOR



RIWH07AVFJ  
RIWH09AVFJ  
RIWH12AVFJ  
RIWH15AVFJ



RIWH18AVFJ  
RIWH24AVFJ

---

OUTDOOR



ROMH45AFXZJ

---

**Notices:**

- Product specifications and design are subject to change without notice for future improvement.
- For further details, please check with our authorized dealer.

# CONTENTS

---

<b>Part 1. INDOOR UNIT</b> .....	<b>1</b>
<b>1. Model lineup</b> .....	<b>2</b>
1-1. Indoor unit connection patterns .....	3
<b>2. Specifications</b> .....	<b>6</b>
2-1. Wall mounted type .....	6
<b>3. Dimensions</b> .....	<b>8</b>
3-1. Wall mounted type .....	8
<b>4. Wiring diagrams</b> .....	<b>12</b>
4-1. Wall mounted type .....	12
<b>5. Air velocity and temperature distributions</b> .....	<b>14</b>
5-1. Wall mounted type .....	14
<b>6. Airflow</b> .....	<b>20</b>
6-1. Wall mounted type .....	20
<b>7. Noise level curve</b> .....	<b>22</b>
7-1. Wall mounted type .....	22
7-2. Sound level check point .....	25
<b>8. Electrical characteristics</b> .....	<b>26</b>
<b>9. Safety devices</b> .....	<b>27</b>
<b>10. External input and output</b> .....	<b>28</b>
10-1.External input.....	28
10-2.External output.....	30
<b>11. Remote controller</b> .....	<b>33</b>
11-1.Wireless remote controller (AR-RAH2U).....	33
11-2.Wireless remote controller (AR-REG1U).....	35
11-3.Wired remote controller (RXRNNUM: Optional part).....	37
11-4.Simple remote controller (RXRSNUM: Optional part) .....	42
<b>12. Function settings</b> .....	<b>47</b>
12-1.Indoor unit (setting by wireless remote controller).....	47
12-2.Indoor unit (setting by wired remote controller) .....	60
12-3.Indoor unit (setting by simple remote controller) .....	63
12-4.Function details.....	67
12-5.Wired remote controller.....	71
12-6.Simple remote controller .....	73
<b>13. Accessories</b> .....	<b>74</b>
13-1.Wall mounted type .....	74
<b>14. Optional parts</b> .....	<b>76</b>
14-1.Controllers .....	76
14-2.Others .....	77
<b>15. Indoor unit installation precautions</b> .....	<b>78</b>

## **CONTENTS (continued)**

15-1.Place where prohibited for use.....	78
15-2.Points to remember when installing .....	79

## CONTENTS (continued)

---

<b>Part 2. OUTDOOR UNIT</b> .....	<b>81</b>
<b>1. Specifications</b> .....	<b>82</b>
1-1. Model: ROMH45AFXZJ .....	82
<b>2. Dimensions</b> .....	<b>83</b>
2-1. Model: ROMH45AFXZJ .....	83
<b>3. Installation space</b> .....	<b>84</b>
3-1. Model: ROMH45AFXZJ .....	84
<b>4. Refrigerant circuit</b> .....	<b>87</b>
4-1. Model: ROMH45AFXZJ .....	87
<b>5. Wiring diagram</b> .....	<b>88</b>
5-1. Model: ROMH45AFXZJ .....	88
<b>6. Capacity table</b> .....	<b>89</b>
6-1. Combinations .....	89
6-2. Cooling capacity.....	93
6-3. Heating capacity .....	105
<b>7. Capacity compensation rate for pipe length and height difference..</b>	<b>115</b>
7-1. Model: ROMH45AFXZJ .....	115
<b>8. Additional charge calculation</b> .....	<b>119</b>
8-1. Model: ROMH45AFXZJ .....	119
<b>9. Airflow</b> .....	<b>120</b>
9-1. Model: ROMH45AFXZJ .....	120
<b>10. Operation noise (sound pressure)</b> .....	<b>121</b>
10-1.Noise level curve.....	121
10-2.Sound level check point .....	121
<b>11. Electrical characteristics</b> .....	<b>122</b>
<b>12. Safety devices</b> .....	<b>123</b>
<b>13. Function settings</b> .....	<b>124</b>
13-1.Setting methods .....	124
13-2.Outdoor unit low noise operation function (option).....	127
<b>14. Check and test</b> .....	<b>128</b>
14-1.Check run .....	128
14-2.Test run.....	134
14-3.Error code .....	136
14-4.Pump down.....	139
<b>15. Accessories</b> .....	<b>141</b>
<b>16. Outdoor unit installation precautions</b> .....	<b>142</b>
16-1.Place where prohibited for use.....	142
16-2.Points to remember when installing .....	142



# **Part 1. INDOOR UNIT**

---

## **WALL MOUNTED TYPE:**

**RIWH07AVFJ**

**RIWH09AVFJ**



**RIWH12AVFJ**

**RIWH15AVFJ**

**RIWH18AVFJ**

**RIWH24AVFJ**

# 1. Model lineup

Indoor unit	
RIWH07AVFJ RIWH09AVFJ RIWH12AVFJ RIWH15AVFJ	RIWH18AVFJ RIWH24AVFJ
	

Outdoor unit
ROMH45AFXZJ

## ● Indoor units that can be connected to each outdoor unit

●: Connectable / -: Not connectable

Outdoor unit		Wall mounted					
		RIWH07—24AVFJ					
	kBtu Class	07	09	12	15	18	24
5 Rooms	ROMH45AFXZJ	●	●	●	●	●	●



# 1-1. Indoor unit connection patterns

## ● 5 rooms

ROMH45AFXZJ						
No.	room 1	room 2	room 3	room 4	room 5	total
1	18	18	—	—	—	36
2	12	24	—	—	—	36
3	15	24	—	—	—	39
4	18	24	—	—	—	42
5	24	24	—	—	—	48
6	7	7	24	—	—	38
7	7	9	18	—	—	34
8	7	9	24	—	—	40
9	7	12	18	—	—	37
10	7	12	24	—	—	43
11	7	15	15	—	—	37
12	7	15	18	—	—	40
13	7	15	24	—	—	46
14	7	18	18	—	—	43
15	7	18	24	—	—	49
16	9	9	18	—	—	36
17	9	9	24	—	—	42
18	9	12	15	—	—	36
19	9	12	18	—	—	39
20	9	12	24	—	—	45
21	9	15	15	—	—	39
22	9	15	18	—	—	42
23	9	15	24	—	—	48
24	9	18	18	—	—	45
25	9	18	24	—	—	51
26	12	12	12	—	—	36
27	12	12	15	—	—	39
28	12	12	18	—	—	42
29	12	12	24	—	—	48
30	12	15	15	—	—	42
31	12	15	18	—	—	45
32	12	15	24	—	—	51
33	12	18	18	—	—	48
34	12	18	24	—	—	54
35	15	15	15	—	—	45
36	15	15	18	—	—	48
37	15	15	24	—	—	54
38	15	18	18	—	—	51
39	18	18	18	—	—	54
40	7	7	7	15	—	36
41	7	7	7	18	—	39
42	7	7	7	24	—	45
43	7	7	9	12	—	35
44	7	7	9	15	—	38
45	7	7	9	18	—	41
46	7	7	9	24	—	47
47	7	7	12	12	—	38
48	7	7	12	15	—	41
49	7	7	12	18	—	44
50	7	7	12	24	—	50

ROMH45AFXZJ						
51	7	7	15	15	—	44
52	7	7	15	18	—	47
53	7	7	15	24	—	53
54	7	7	18	18	—	50
55	7	9	9	9	—	34
56	7	9	9	12	—	37
57	7	9	9	15	—	40
58	7	9	9	18	—	43
59	7	9	9	24	—	49
60	7	9	12	12	—	40
61	7	9	12	15	—	43
62	7	9	12	18	—	46
63	7	9	12	24	—	52
64	7	9	15	15	—	46
65	7	9	15	18	—	49
66	7	9	18	18	—	52
67	7	12	12	12	—	43
68	7	12	12	15	—	46
69	7	12	12	18	—	49
70	7	12	15	15	—	49
71	7	12	15	18	—	52
72	7	15	15	15	—	52
73	9	9	9	9	—	36
74	9	9	9	12	—	39
75	9	9	9	15	—	42
76	9	9	9	18	—	45
77	9	9	9	24	—	51
78	9	9	12	12	—	42
79	9	9	12	15	—	45
80	9	9	12	18	—	48
81	9	9	12	24	—	54
82	9	9	15	15	—	48
83	9	9	15	18	—	51
84	9	9	18	18	—	54
85	9	12	12	12	—	45
86	9	12	12	15	—	48
87	9	12	12	18	—	51
88	9	12	15	15	—	51
89	9	12	15	18	—	54
90	12	12	12	12	—	48
91	12	12	12	15	—	51
92	12	12	12	18	—	54
93	12	12	12	18	—	54
94	12	12	15	15	—	54
95	7	7	7	7	7	35
96	7	7	7	7	9	37
97	7	7	7	7	12	40
98	7	7	7	7	15	43
99	7	7	7	7	18	46
100	7	7	7	7	24	52
101	7	7	7	9	9	39
102	7	7	7	9	12	42
103	7	7	7	9	15	45
104	7	7	7	9	18	48
105	7	7	7	9	24	54
106	7	7	7	12	12	45

ROMH45AFXZJ						
107	7	7	7	12	15	48
108	7	7	7	12	18	51
109	7	7	7	15	15	51
110	7	7	7	15	18	54
111	7	7	9	9	9	41
112	7	7	9	9	12	44
113	7	7	9	9	15	47
114	7	7	9	9	18	50
115	7	7	9	12	12	47
116	7	7	9	12	15	50
117	7	7	9	12	18	53
118	7	7	9	15	15	53
119	7	7	12	12	12	50
120	7	7	12	12	15	53
121	7	9	9	9	9	43
122	7	9	9	9	12	46
123	7	9	9	9	15	49
124	7	9	9	9	18	52
125	7	9	9	12	12	49
126	7	9	9	12	15	52
127	7	9	12	12	12	52
128	9	9	9	9	9	45
129	9	9	9	9	12	48
130	9	9	9	9	15	51
131	9	9	9	9	18	54
132	9	9	9	12	12	51
133	9	9	9	12	15	54
134	9	9	12	12	12	54

7: 7,000Btu/h, 9: 9,000Btu/h, 12: 12,000Btu/h, 15: 14,000Btu/h, 18: 18,000Btu/h,  
24: 24,000Btu/h

## 2. Specifications

### 2-1. Wall mounted type

Model name			RIWH07AVFJ	RIWH09AVFJ	RIWH12AVFJ	RIWH15AVFJ		
Power supply			208/230 V ~ 60 Hz					
Available voltage range			187—264 V					
Capacity		Btu/h class	7,000	9,000	12,000	14,000		
Input power		W	15	17	22	28		
Running current		A	0.13	0.15	0.19	0.25		
Fan	Airflow rate	Cooling	HIGH	330 (560)	353 (600)	388 (660)	430 (730)	
			MED	294 (500)	306 (520)	330 (560)	353 (600)	
			LOW	253 (430)	253 (430)	265 (450)	312 (530)	
			QUIET	182 (310)	182 (310)	182 (310)	212 (360)	
		Heating	HIGH	330 (560)	353 (600)	388 (660)	430 (730)	
			MED	294 (500)	306 (520)	330 (560)	362 (615)	
			LOW	253 (430)	253 (430)	277 (470)	330 (560)	
			QUIET	194 (330)	194 (330)	194 (330)	221 (375)	
			Type × Q'ty		Cross flow fan × 1			
			Motor output		W	30		
Sound pressure level *	Cooling	HIGH	36	37	40	42		
		MED	32	33	36	38		
		LOW	29	29	30	33		
		QUIET	21	21	21	25		
	Heating	HIGH	36	37	40	42		
		MED	32	33	36	38		
		LOW	29	29	31	35		
		QUIET	22	22	22	27		
Heat exchanger type	Dimensions (H × W × D)	in (mm)	Main: 12-5/8 × 24-13/16 × 13/16 (320 × 630 × 20) Sub: 3-5/16 × 24-13/16 × 1/2 (84 × 630 × 13.3)					
	Fin pitch	FPI	Main: 23, Sub: 18					
	Rows × Stages		Main: 2 × 20, Sub: 1 × 4					
	Pipe type		Copper tube					
	Fin type		Aluminum					
Enclosure	Material		Polystyrene					
	Color		White (Approximate color of MUNSELL N9.25 J)					
Dimensions (H × W × D)	Net	in (mm)	10-5/8 × 34-1/4 × 8-1/16 (270 × 870 × 204)					
	Gross		10-5/8 × 36-7/16 × 13-1/4 (270 × 925 × 336)					
Weight	Net	lb (kg)	19 (8.5)					
	Gross		24 (11)					
Connection pipe	Size	Liquid	Ø1/4 (Ø6.35)					
		Gas	Ø3/8 (Ø9.52)		Ø1/2 (Ø12.70)			
	Method		Flare					
Drain hose	Material		PP + LLDPE					
	Size	in (mm)	Ø 9/16(I.D.), Ø 5/8 to Ø 11/16(O.D.) [Ø 13.8(I.D.), Ø 15.8 to Ø 16.7(O.D.)]					
Operation range	Cooling	°F (°C)	64 to 90 (18 to 32)					
		%RH	80 or less					
Operation range	Heating	°F (°C)	60 to 88 (16 to 30)					
			Wireless (Wired [option])					
<b>NOTES:</b> <ul style="list-style-type: none"> <li>The protective function might work when using it outside the operation range.</li> <li>*Sound pressure level: <ul style="list-style-type: none"> <li>Measured values in manufacturer's anechoic chamber.</li> <li>Because of the surrounding sound environment, the sound levels measured in actual installation conditions might be higher than the specified values here.</li> </ul> </li> </ul>								

Model name				RIWH18AVFJ	RIWH24AVFJ	
Power supply				208/230 V ~ 60 Hz		
Available voltage range				187—264 V		
Capacity			Btu/h class	18,000	24,000	
Input power			W	41	69	
Running current			A	0.32	0.53	
Fan	Airflow rate	Cooling	HIGH	CFM (m <sup>3</sup> /h)	542 (920)	659 (1,120)
			MED		436 (740)	530 (900)
			LOW		365 (620)	436 (740)
			QUIET		324 (550)	365 (620)
		Heating	HIGH		542 (920)	647 (1,100)
			MED		436 (740)	530 (900)
			LOW		365 (620)	436 (740)
			QUIET		324 (550)	365 (620)
	Type × Q'ty			Cross flow fan ×1		
	Motor output			W	42	
Sound pressure level *	Cooling	HIGH	dB (A)	43	49	
		MED		37	42	
		LOW		33	37	
		QUIET		31	33	
	Heating	HIGH		44	48	
		MED		37	42	
		LOW		33	37	
		QUIET		31	33	
Heat exchanger type	Dimensions (H × W × D)		in (mm)	Main: 15-7/8 × 33-3/4 × 1-1/16 (378 × 832 × 26.6) Sub: 3-5/16 × 33-3/4 × 1/2 (84 × 832 × 13.3)		
	Fin pitch		FPI	Main: 21, Sub: 18		
	Rows × Stages			Main: 2 × 18, Sub: 1 × 4		
	Pipe type			Copper tube		
	Fin type			Aluminum		
Enclosure	Material			Polystyrene		
	Color			White (Approximate color of MUNSELL N9.25 /)		
Dimensions (H × W × D)	Net		in (mm)	12-5/8 × 39-5/16 × 9-3/8 (320 × 998 × 238)		
	Gross			12-15/16 × 42-15/16 × 16-9/16 (329 × 1,090 × 420)		
Weight	Net		lb (kg)	31 (14)		
	Gross			40 (18)		
Connection pipe	Size	Liquid	mm (in)	Ø1/4 (Ø6.35)		
		Gas		Ø1/2 (Ø12.70)	Ø5/8 (Ø15.88)	
	Method			Flare		
Drain hose	Material			PVC		
	Size		in (mm)	Ø 1/2(I.D.), Ø 5/8(O.D.) [Ø 12(I.D.), Ø 16(O.D.)]		
Operation range	Cooling			64 to 90 (18 to 32)		
				%RH 80 or less		
	Heating			60 to 88 (16 to 30)		
Remote controller type				Wireless (Wired [option])		
<p><b>NOTES:</b></p> <ul style="list-style-type: none"> <li>• The protective function might work when using it outside the operation range.</li> <li>• *Sound pressure level: <ul style="list-style-type: none"> <li>– Measured values in manufacturer's anechoic chamber.</li> <li>– Because of the surrounding sound environment, the sound levels measured in actual installation conditions might be higher than the specified values here.</li> </ul> </li> </ul>						

### 3. Dimensions

#### 3-1. Wall mounted type

■ Models: RIWH07AVFJ, RIWH09AVFJ, RIWH12AVFJ, and RIWH15AVFJ

Unit: in (mm)

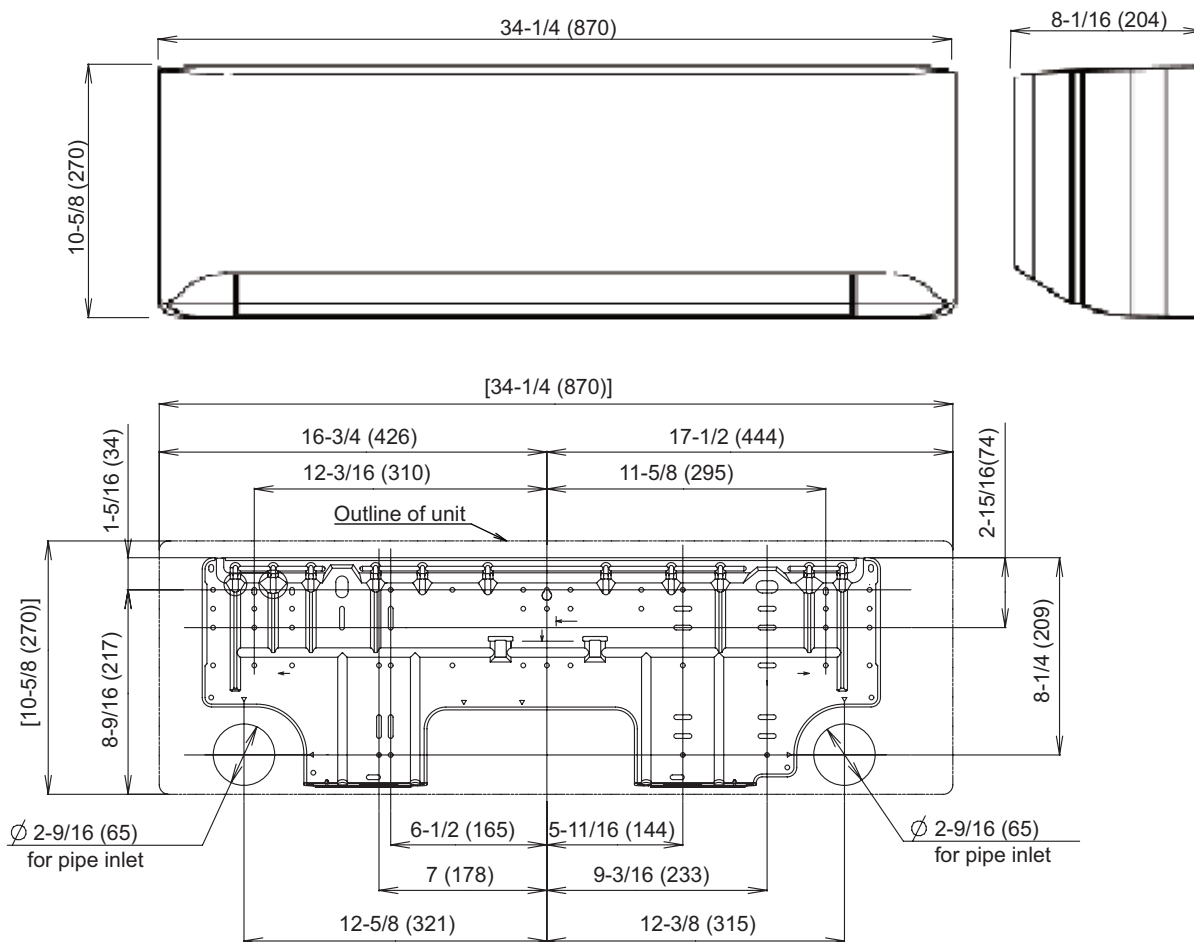

## ● Installation space requirement

Provide sufficient installation space for product safety.

Unit: in (mm)

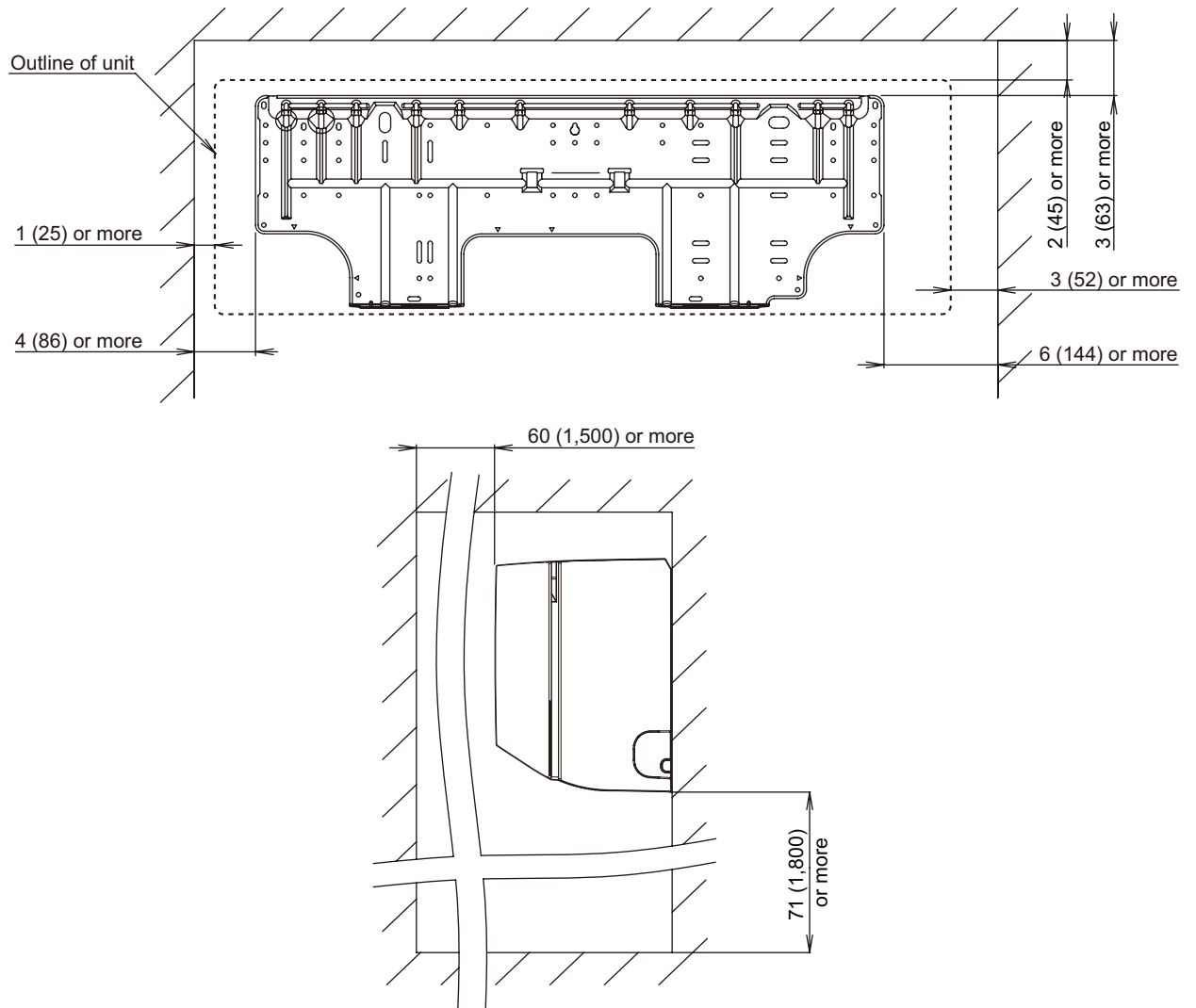

■ Models: RIWH18AVFJ and RIWH24AVFJ

Unit: in (mm)

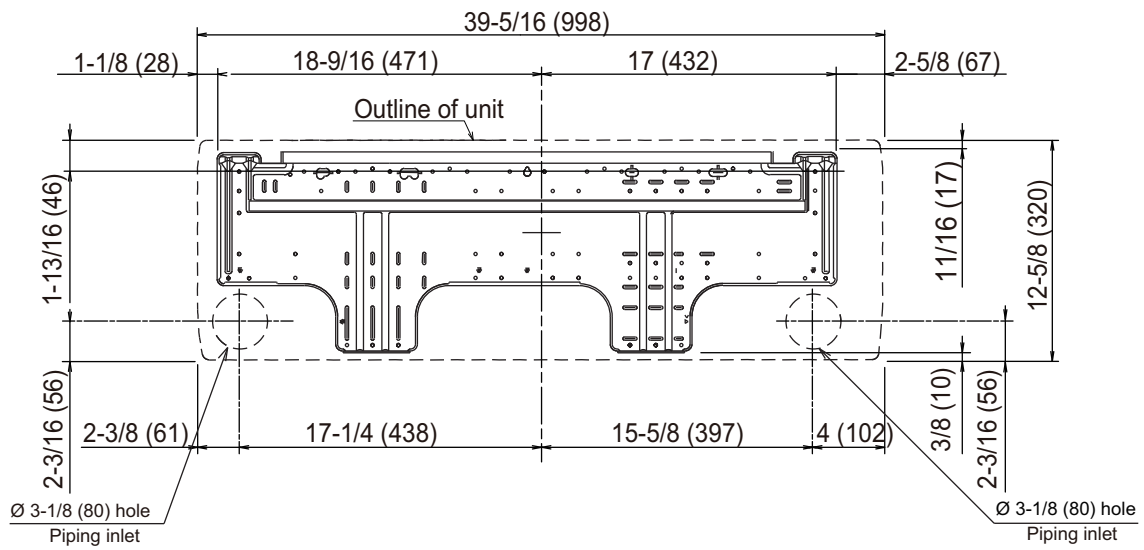
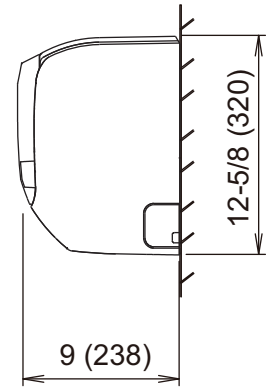
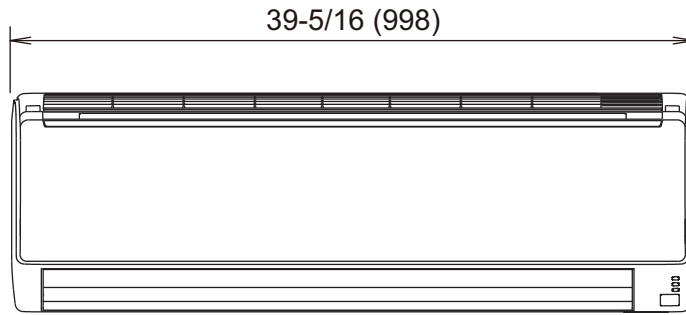



## ● Installation space requirement

Provide sufficient installation space for product safety.

Unit: in (mm)

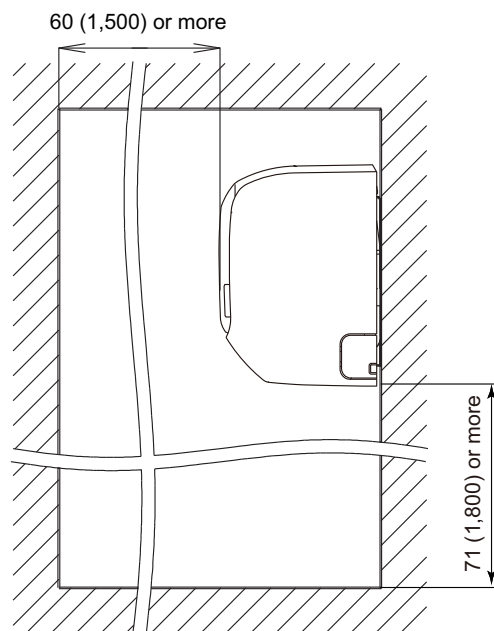
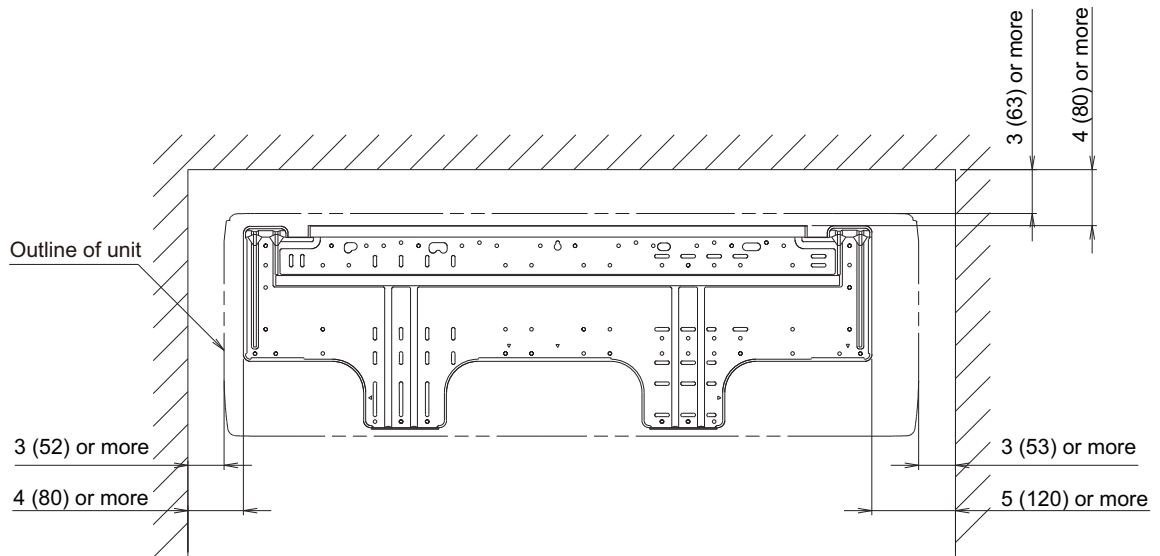

## 4. Wiring diagrams

### 4-1. Wall mounted type

■ Models: RIWH07AVFJ, RIWH09AVFJ, RIWH12AVFJ, and RIWH15AVFJ

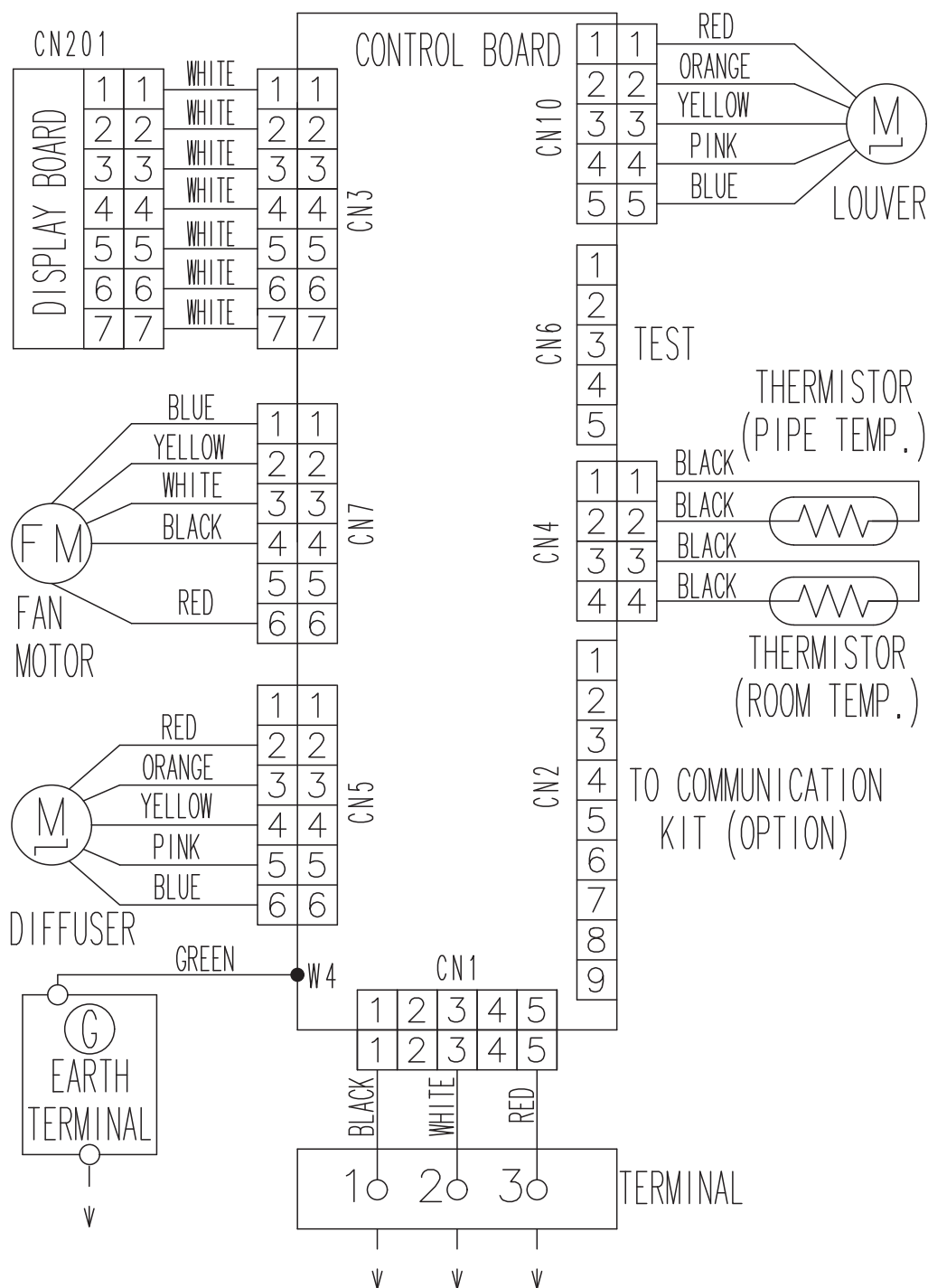

# Models: RIWH18AVFJ and RIWH24AVFJ

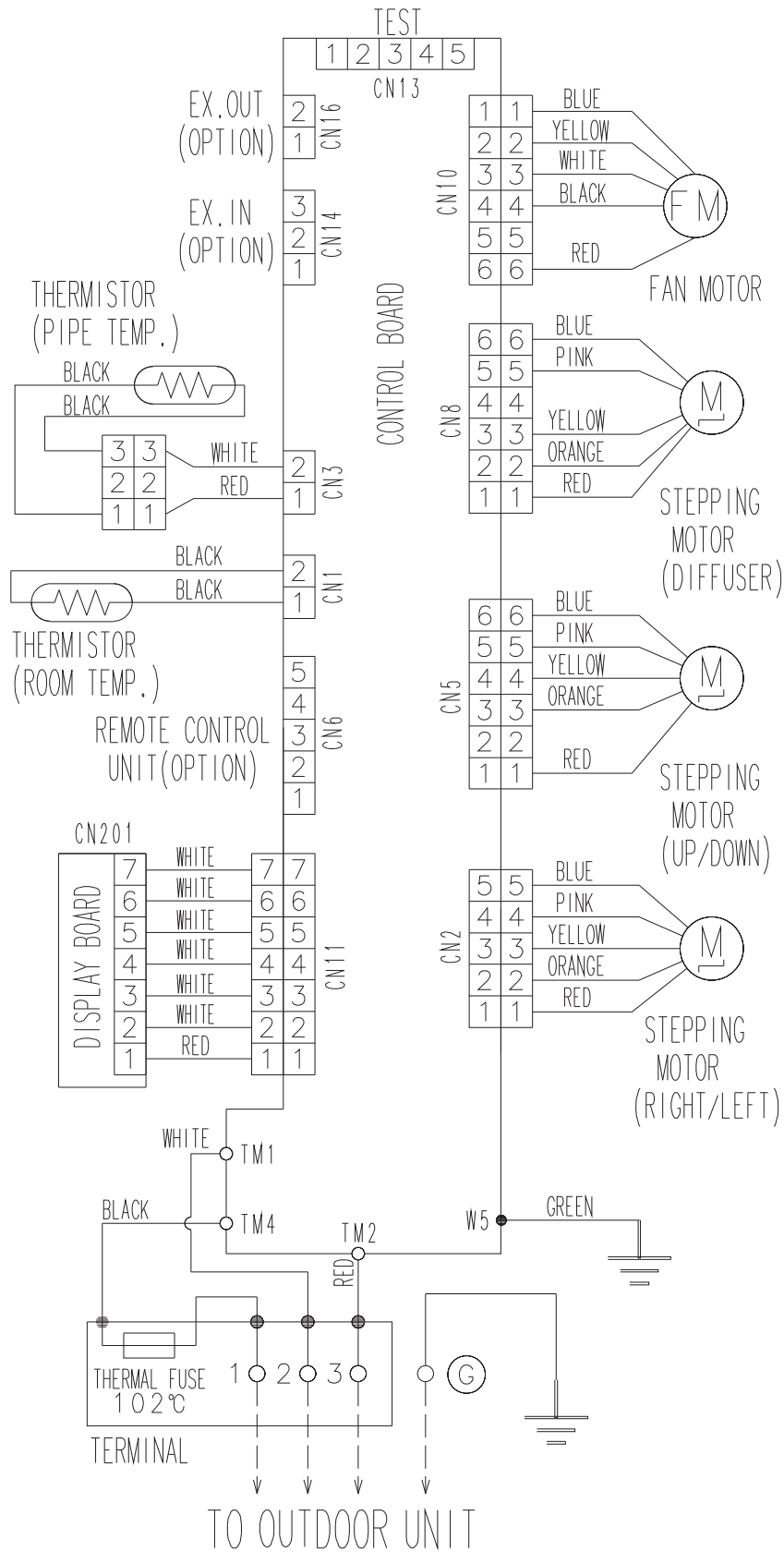

# 5. Air velocity and temperature distributions

## 5-1. Wall mounted type

### Model: RIWH07AVFJ

Measuring conditions	Fan speed	Operation mode
	HIGH	FAN

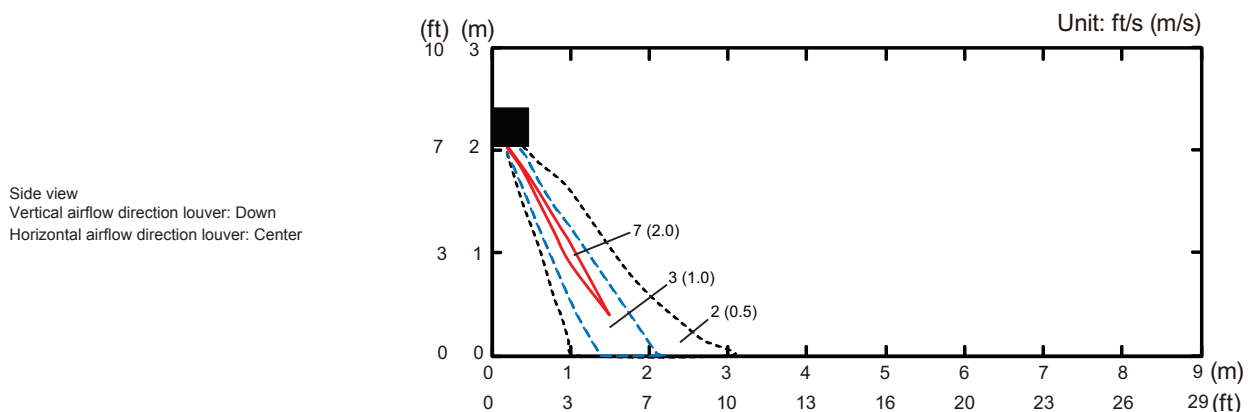
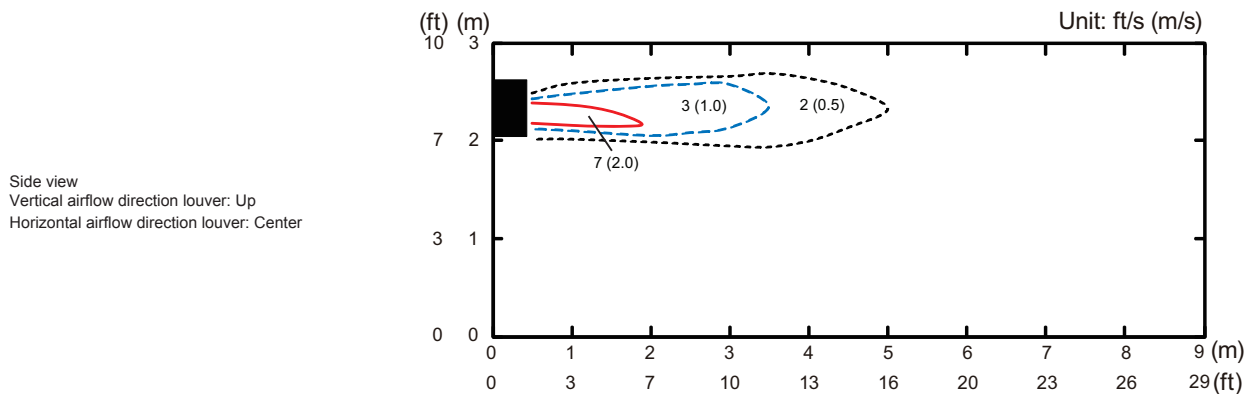
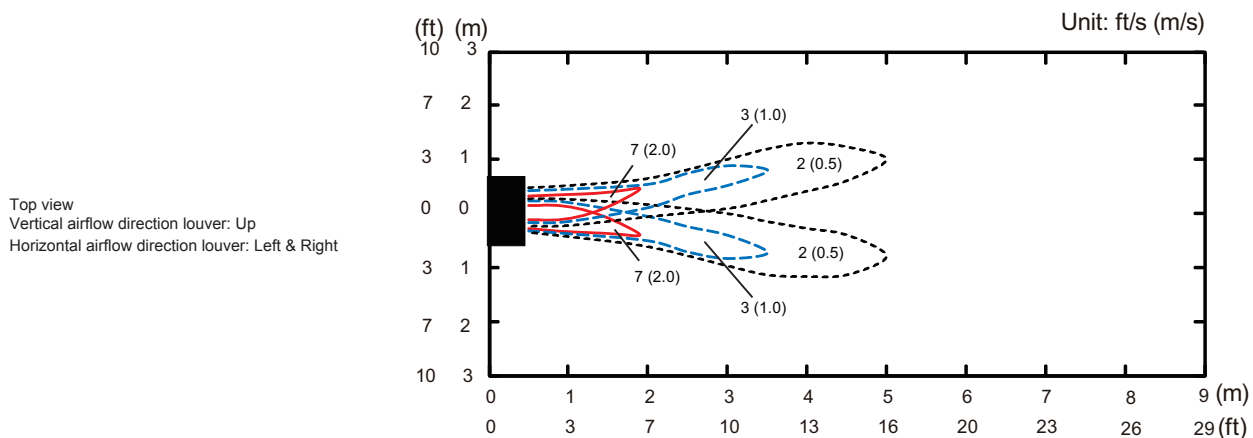
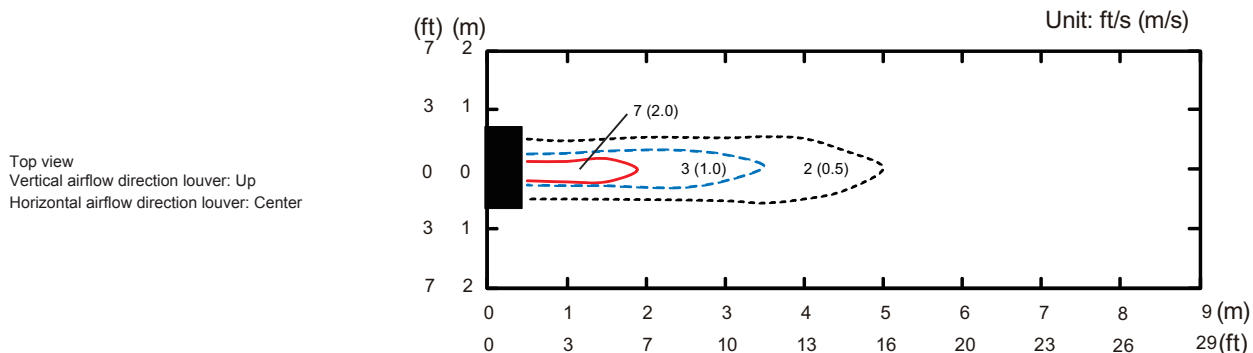

# Model: RIWH09AVFJ

Measuring conditions	Fan speed	Operation mode
	HIGH	FAN

MULTI TYPE  
5 rooms type

Top view  
Vertical airflow direction louver: Up  
Horizontal airflow direction louver: Center

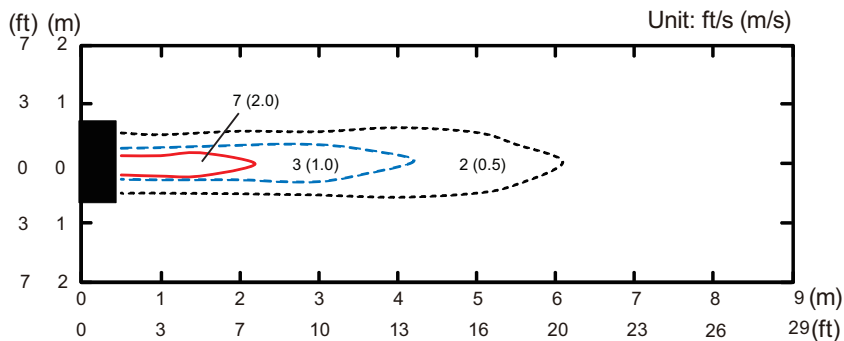

Top view  
Vertical airflow direction louver: Up  
Horizontal airflow direction louver: Left & Right

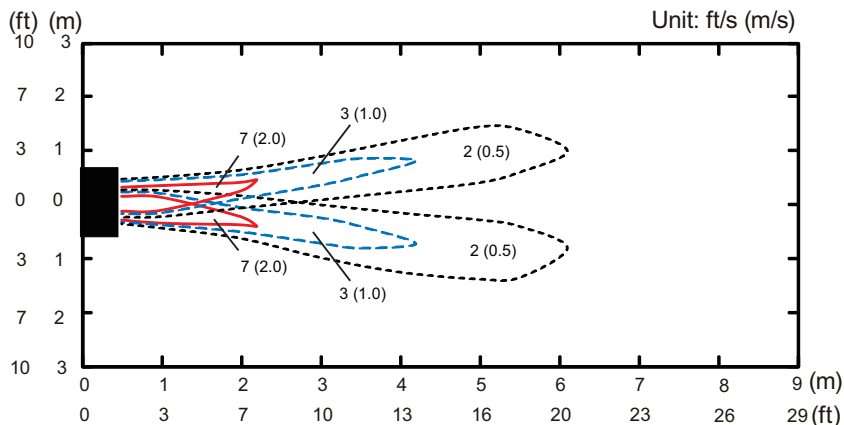

Side view  
Vertical airflow direction louver: Up  
Horizontal airflow direction louver: Center

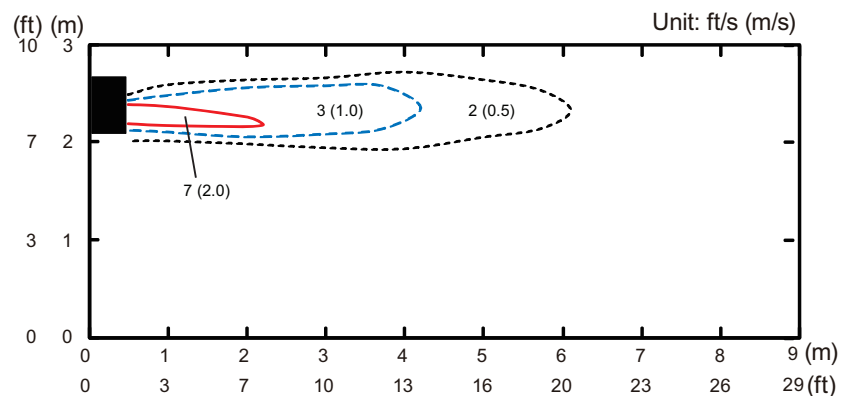

Side view  
Vertical airflow direction louver: Down  
Horizontal airflow direction louver: Center

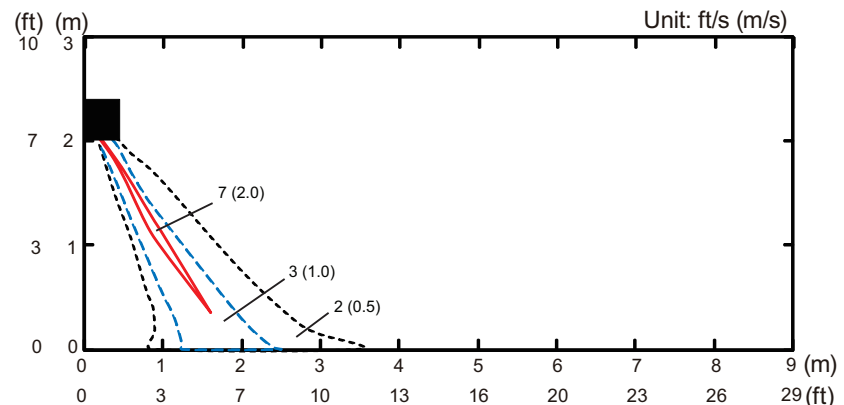

# Model: RIWH12AVFJ

Measuring conditions	Fan speed	Operation mode
	HIGH	FAN

Top view  
Vertical airflow direction louver: Up  
Horizontal airflow direction louver: Center

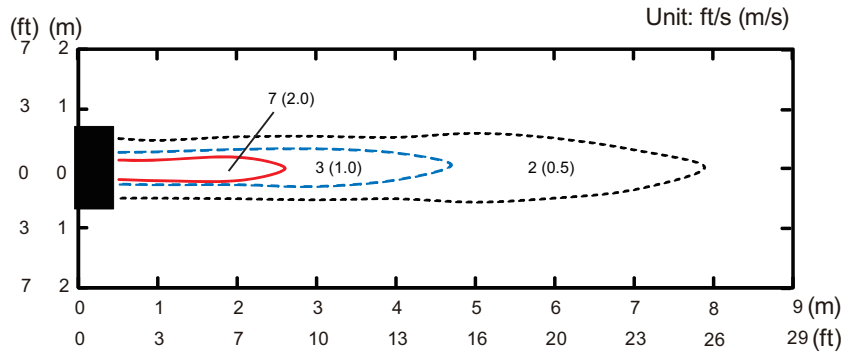

Top view  
Vertical airflow direction louver: Up  
Horizontal airflow direction louver: Left & Right

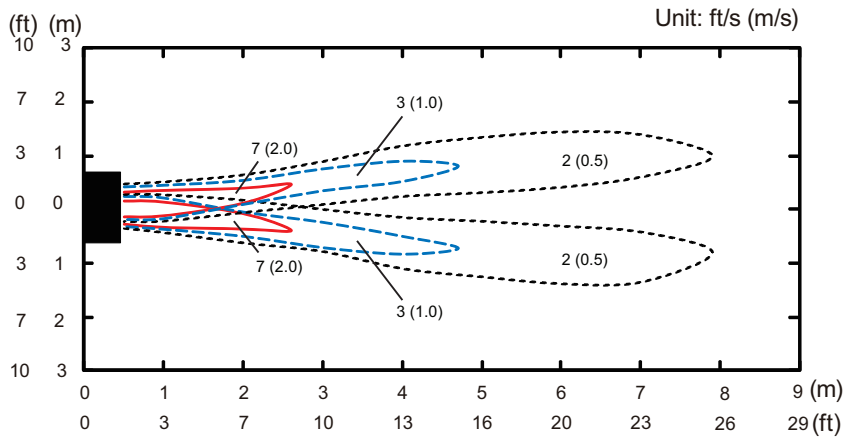

Side view  
Vertical airflow direction louver: Up  
Horizontal airflow direction louver: Center

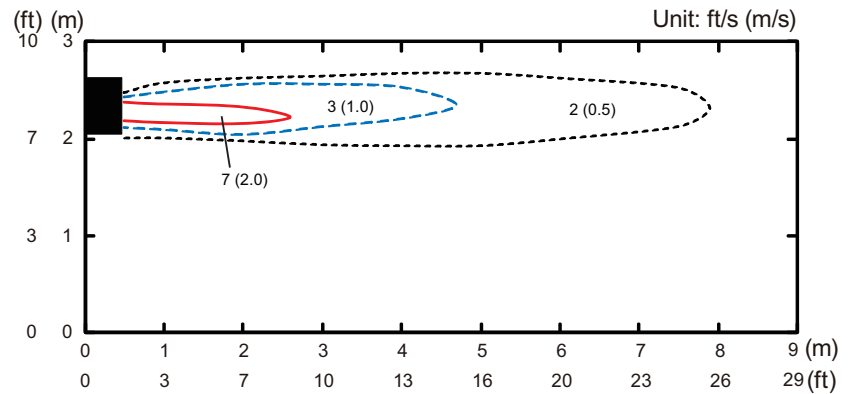

Side view  
Vertical airflow direction louver: Down  
Horizontal airflow direction louver: Center

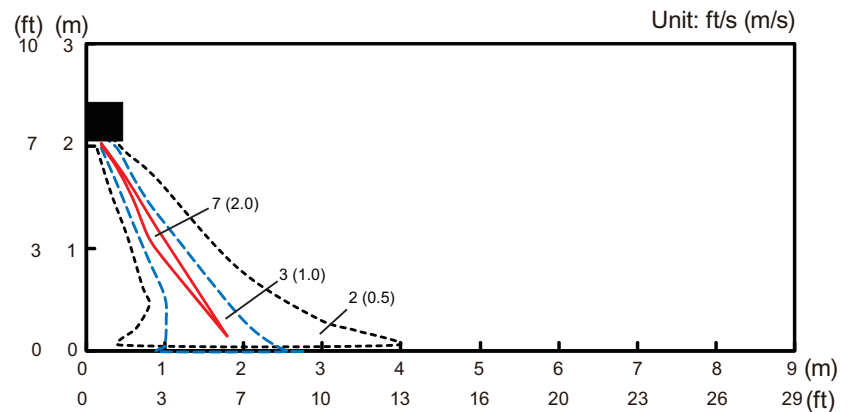

# Model: RIWH15AVFJ

Measuring conditions	Fan speed	Operation mode
	HIGH	FAN

MULTI TYPE  
5 rooms type

Top view  
Vertical airflow direction louver: Up  
Horizontal airflow direction louver: Center

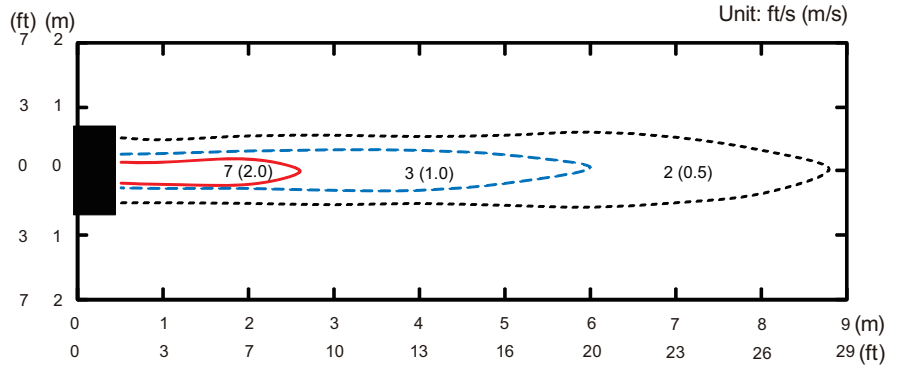

Top view  
Vertical airflow direction louver: Up  
Horizontal airflow direction louver: Left & Right

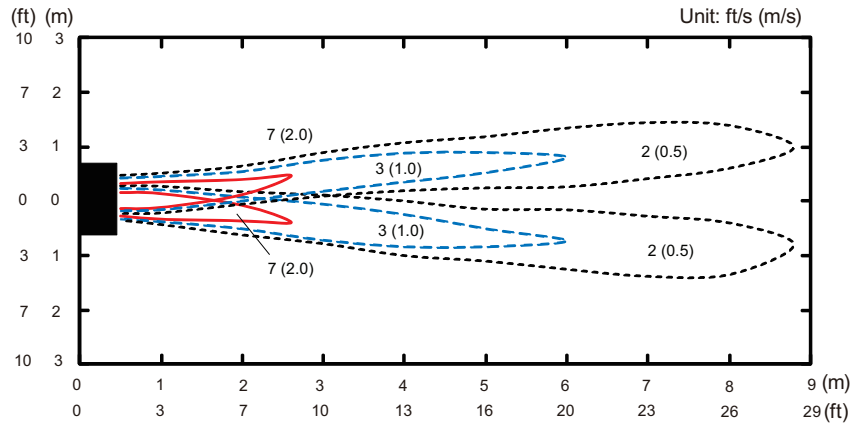

Side view  
Vertical airflow direction louver: Up  
Horizontal airflow direction louver: Center

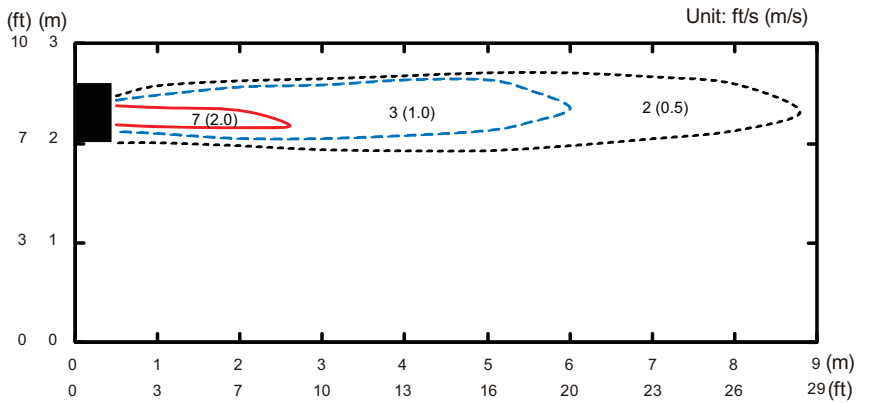

Side view  
Vertical airflow direction louver: Down  
Horizontal airflow direction louver: Center

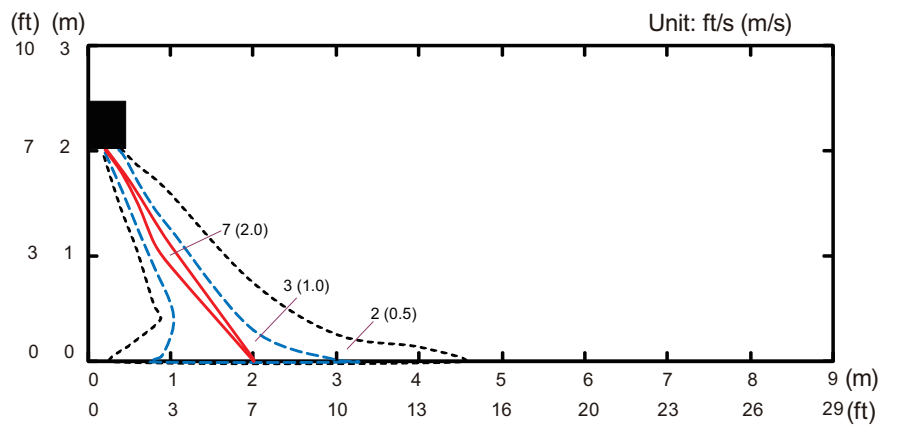

# Model: RIWH18AVFJ

Measuring conditions	Fan speed	Operation mode
	HIGH	FAN

Top view  
Vertical airflow direction louver: Up  
Horizontal airflow direction louver: Center

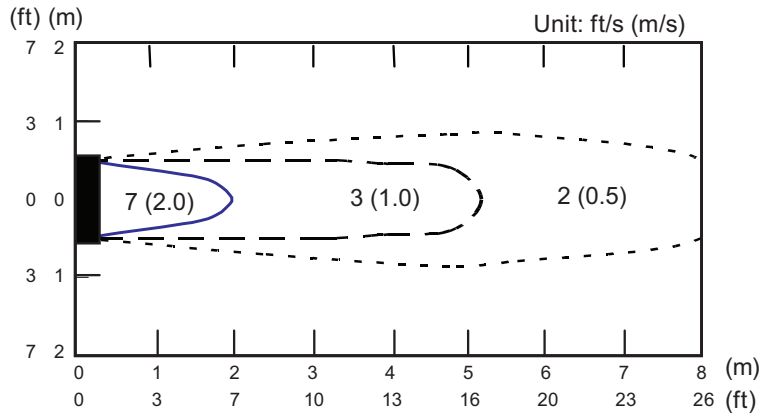

Top view  
Vertical airflow direction louver: Up  
Horizontal airflow direction louver: Left & Right

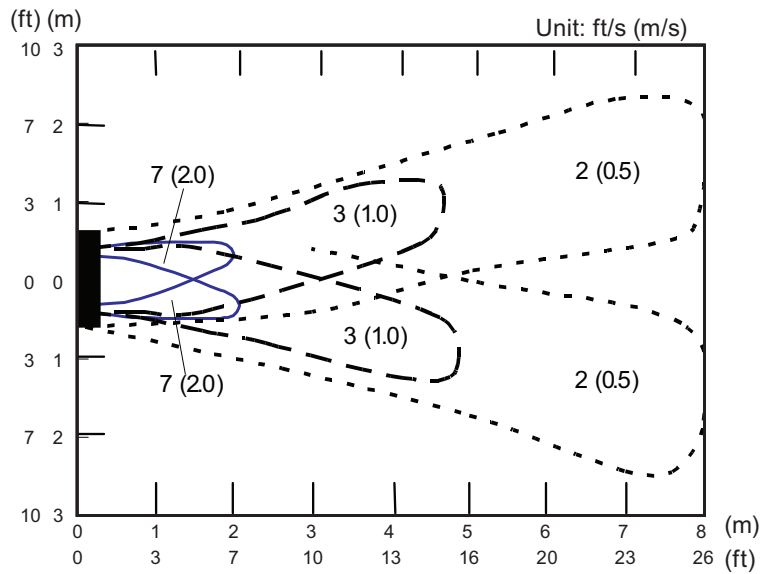

Side view  
Vertical airflow direction louver: Up  
Horizontal airflow direction louver: Center

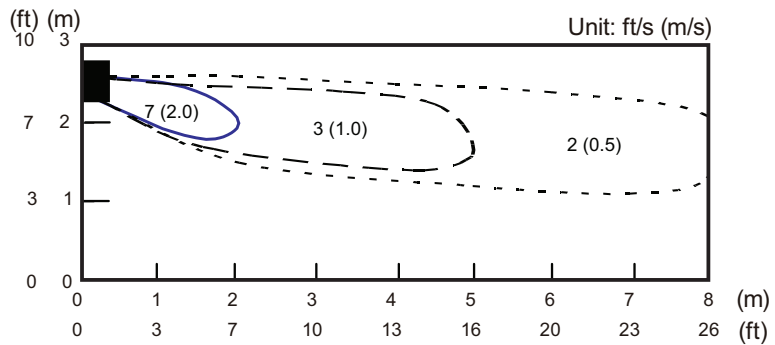

Side view  
Vertical airflow direction louver: Down  
Horizontal airflow direction louver: Center

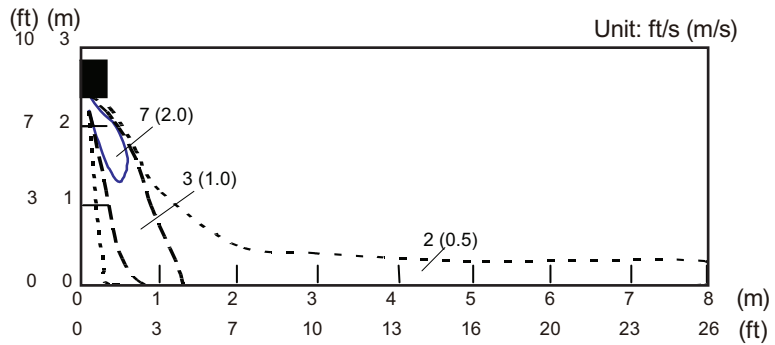



# Model: RIWH24AVFJ

MULTI TYPE  
5 rooms type

Measuring conditions	Fan speed	Operation mode
	HIGH	FAN

Top view  
Vertical airflow direction louver: Up  
Horizontal airflow direction louver: Center

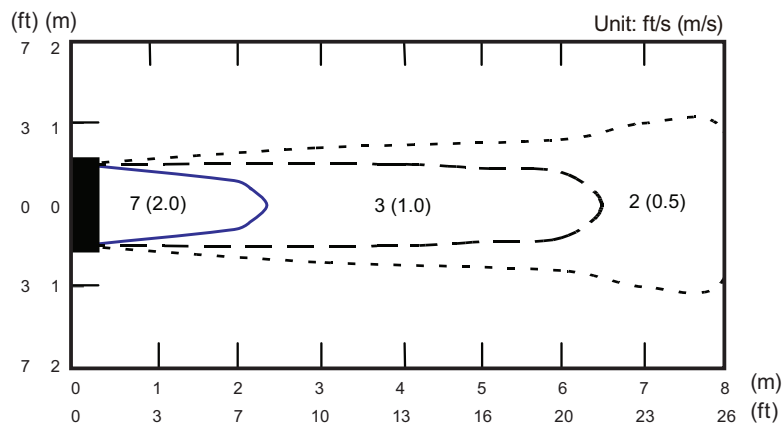

Top view  
Vertical airflow direction louver: Up  
Horizontal airflow direction louver: Left & Right

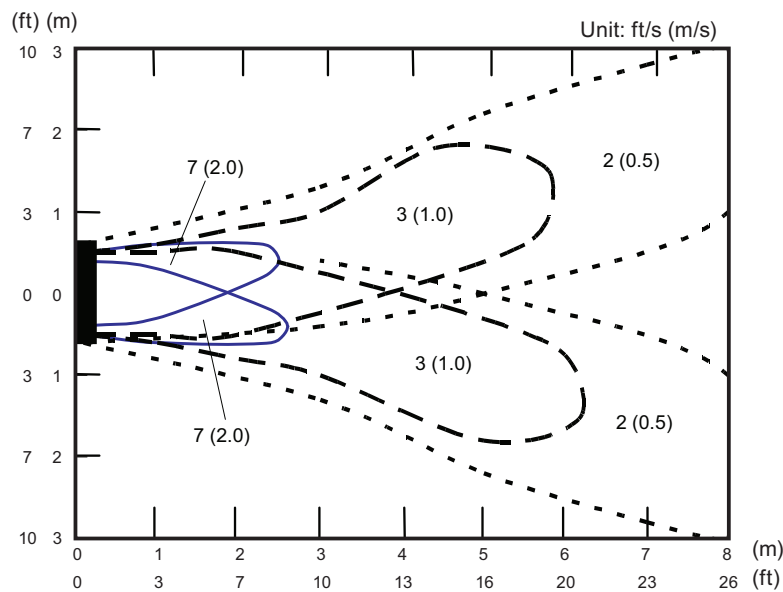

Side view  
Vertical airflow direction louver: Up  
Horizontal airflow direction louver: Center

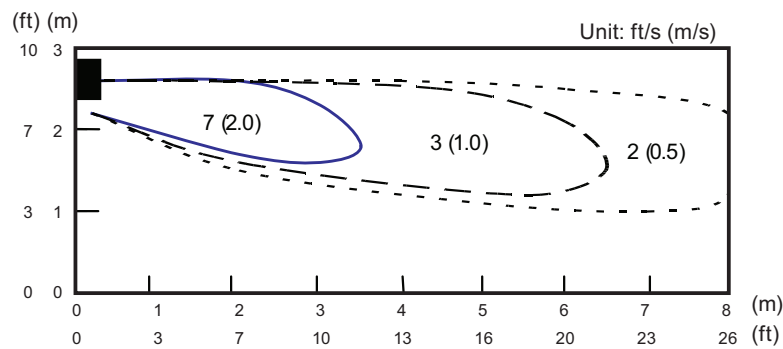

Side view  
Vertical airflow direction louver: Down  
Horizontal airflow direction louver: Center

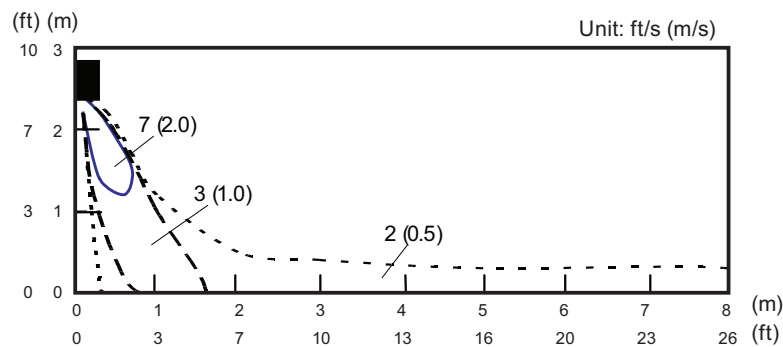

## 6. Airflow

Conversion factor:

- $1 \text{ m}^3/\text{h} = 0.2778 \text{ l/s} = 0.5886 \text{ CFM}$
- $3.6 \text{ m}^3/\text{h} = 1 \text{ l/s}$
- $1.699 \text{ m}^3/\text{h} = 1 \text{ CFM}$

### 6-1. Wall mounted type

Model	Operation mode	Fan speed	Airflow		
			m <sup>3</sup> /h	l/s	CFM
RIWH07AVFJ	Cooling	High	560	156	330
		Med	500	139	294
		Low	430	119	253
		Quiet	310	86	182
	Heating	High	560	156	330
		Med	500	139	294
		Low	430	119	253
		Quiet	330	92	194
RIWH09AVFJ	Cooling	High	600	167	353
		Med	520	144	306
		Low	430	119	253
		Quiet	310	86	182
	Heating	High	600	167	353
		Med	520	144	306
		Low	430	119	253
		Quiet	330	92	194
RIWH12AVFJ	Cooling	High	660	183	388
		Med	560	156	330
		Low	450	125	265
		Quiet	310	86	182
	Heating	High	660	183	388
		Med	560	156	330
		Low	470	131	277
		Quiet	330	92	194
RIWH15AVFJ	Cooling	High	730	203	430
		Med	600	167	353
		Low	530	147	312
		Quiet	360	100	212
	Heating	High	730	203	430
		Med	615	171	362
		Low	560	156	330
		Quiet	375	104	221
RIWH18AVFJ	Cooling	High	920	256	542
		Med	740	206	436
		Low	620	172	365
		Quiet	550	153	324
	Heating	High	920	256	542
		Med	740	206	436
		Low	620	172	365
		Quiet	550	153	324

Model	Operation mode	Fan speed	Airflow		
			m <sup>3</sup> /h	l/s	CFM
RIWH24AVFJ	Cooling	High	1,120	311	659
		Med	900	250	530
		Low	740	206	436
		Quiet	620	172	365
	Heating	High	1,100	306	647
		Med	900	250	530
		Low	740	206	436
		Quiet	620	172	365

# 7. Noise level curve

## 7-1. Wall mounted type

### ■ Model: RIWH07AVFJ

#### ● Cooling

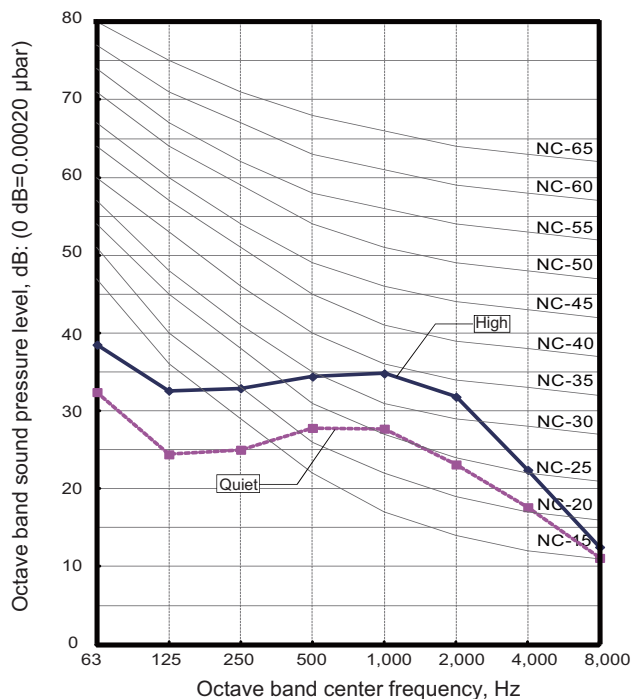

#### ● Heating

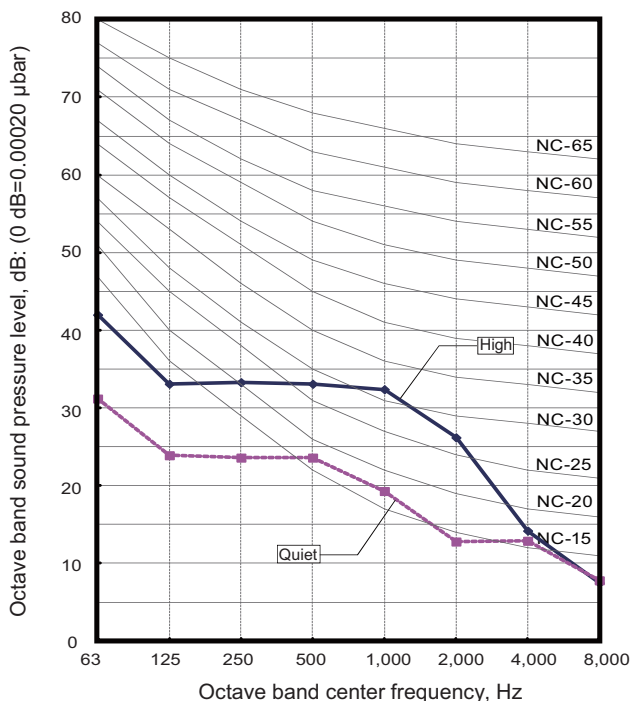

### ■ Model: RIWH09AVFJ

#### ● Cooling

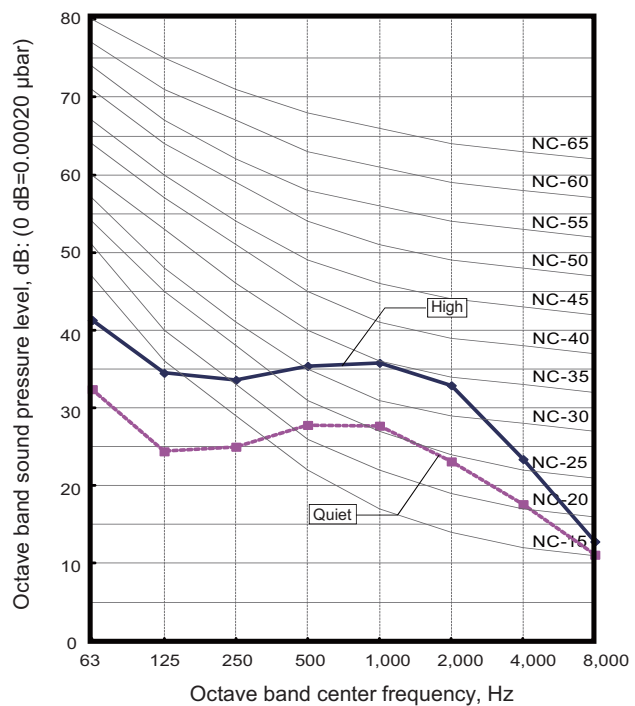

#### ● Heating

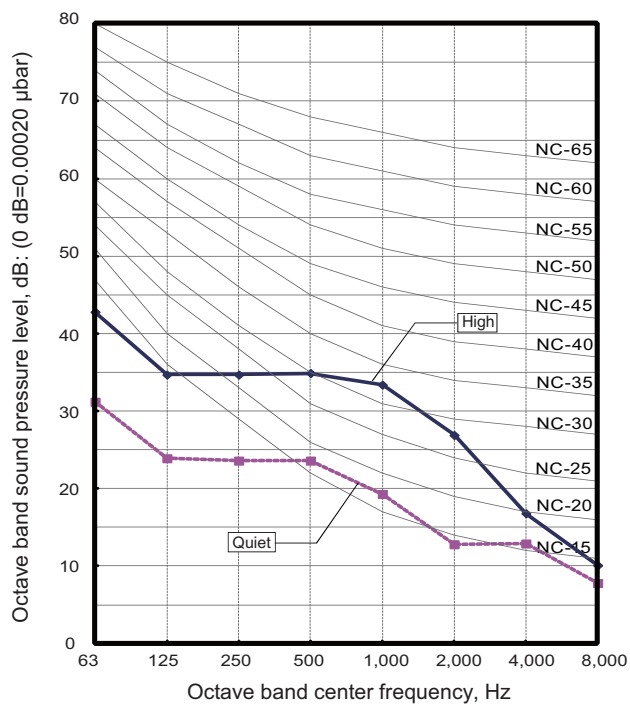

## Model: RIWH12AVFJ

### Cooling

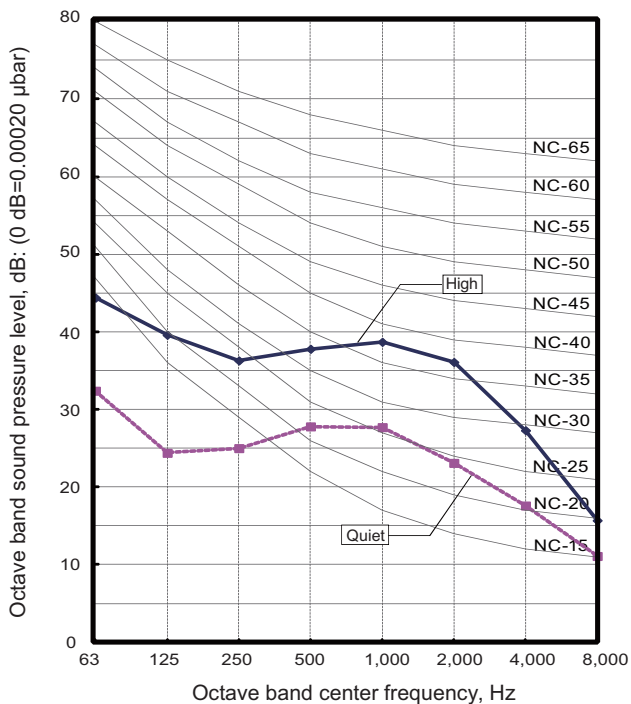

### Heating

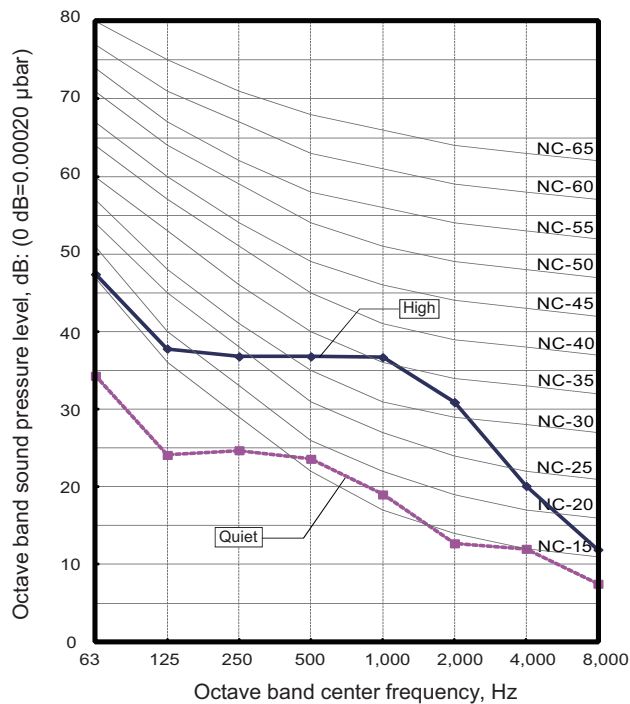

## Model: RIWH15AVFJ

### Cooling

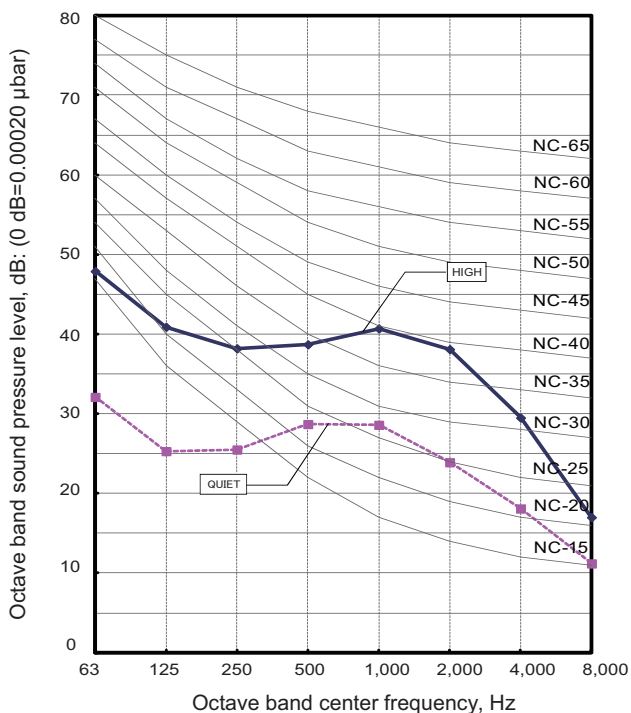

### Heating

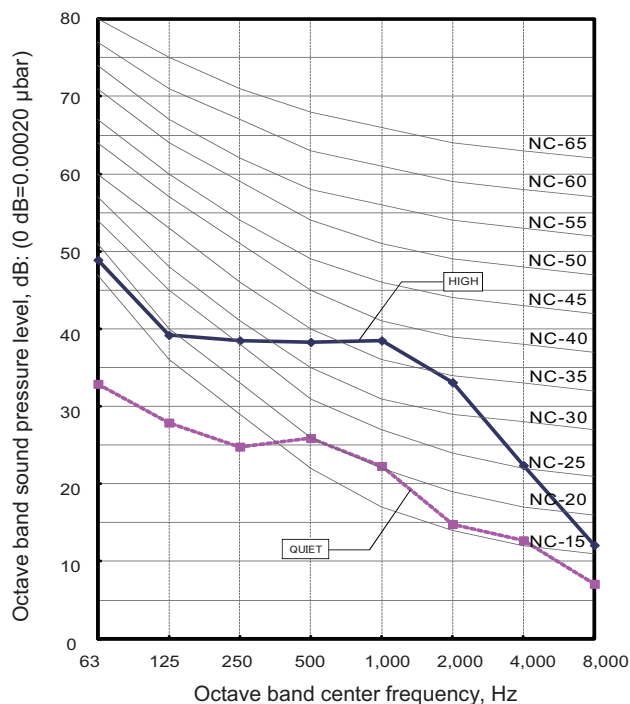

## Model: RIWH18AVFJ

### Cooling

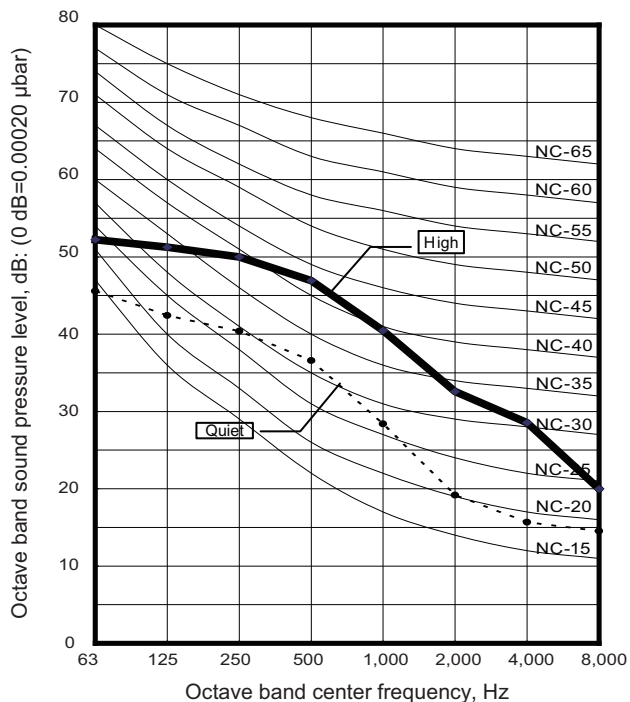

### Heating

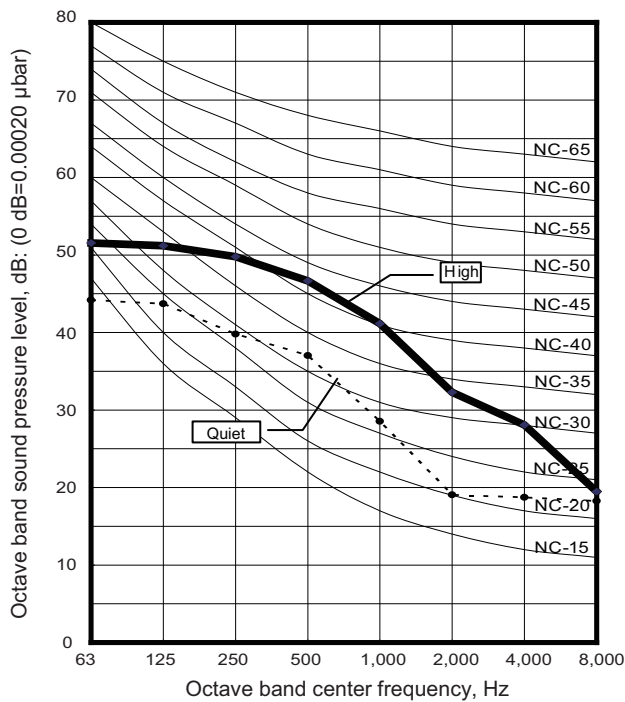

## Model: RIWH24AVFJ

### Cooling

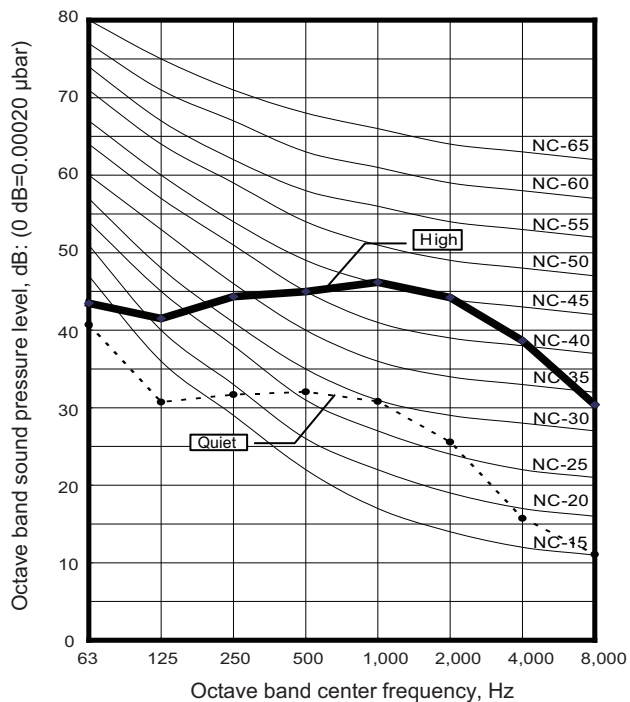

### Heating

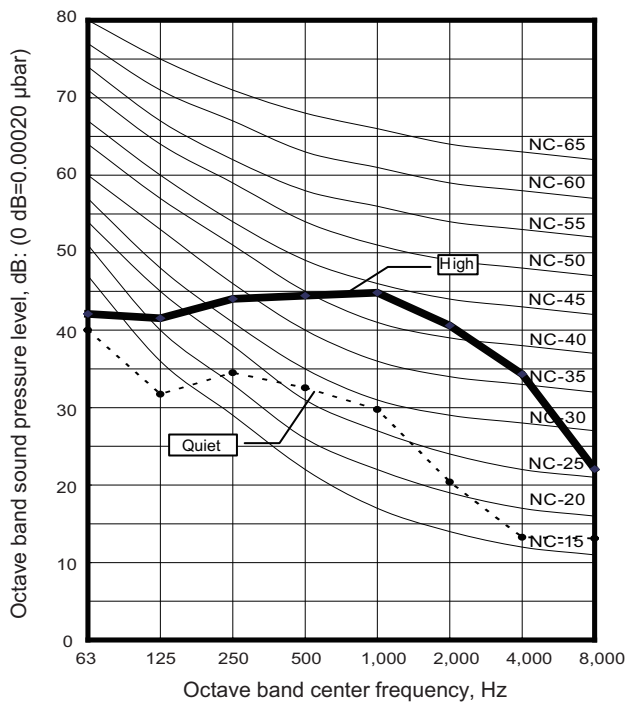

## 7-2. Sound level check point

### ■ Wall mounted type

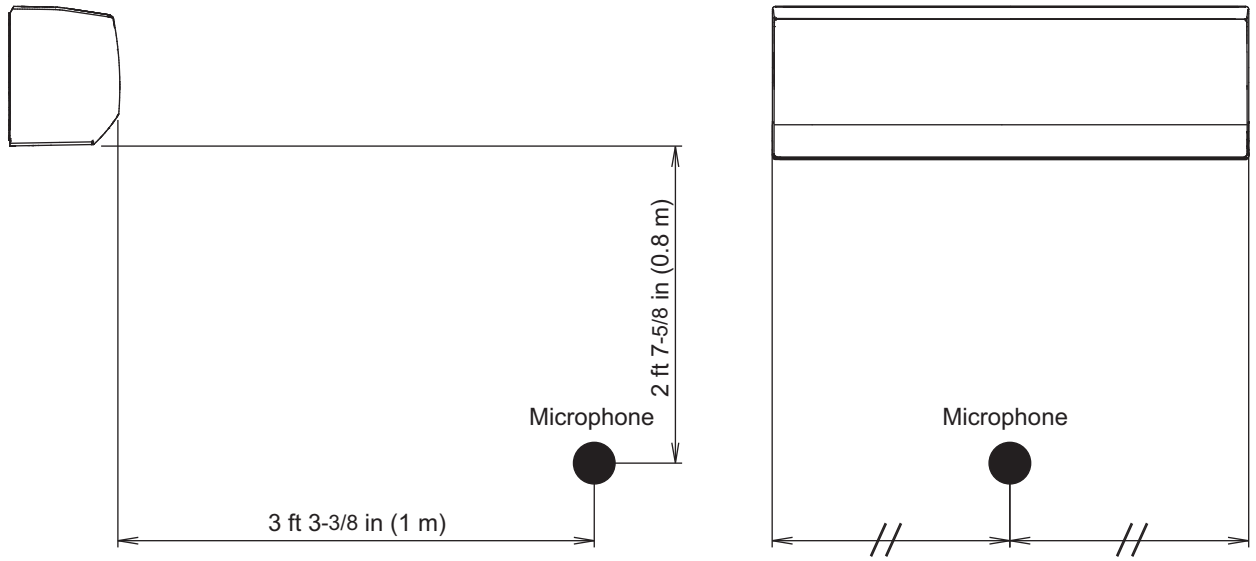

**NOTE:** Detailed shape of the actual indoor unit might be slightly different from the one illustrated above.

## 8. Electrical characteristics

		Power supply			Indoor rated	
Type	Model name	Hz	Voltage (V)	MCA (A)	Input power (W)	FLA (A)
Wall mounted	RIWH07AVFJ	60	208 / 230	0.18 / 0.16	15 / 15	0.14 / 0.13
	RIWH09AVFJ			0.20 / 0.19	17 / 17	0.16 / 0.15
	RIWH12AVFJ			0.25 / 0.24	22 / 22	0.20 / 0.19
	RIWH15AVFJ			0.34 / 0.31	28 / 28	0.27 / 0.25
	RIWH18AVFJ			0.42 / 0.40	40 / 41	0.34 / 0.32
	RIWH24AVFJ			0.71 / 0.66	68 / 69	0.57 / 0.53

Wiring spec. (Indoor unit to outdoor unit)	Connection cable	AWG	14
	Limited wiring length	ft (m)	85 (26)

MCA: Minimum Circuit Ampacity = Maximum operating current (Full load)

FLA: Full Load Amperes (Fan motor)



## 9. Safety devices

Indoor unit type	Model name	PCB* fuse	Fan motor thermal protector	Terminal thermal fuse	Float switch
Wall mounted	RIWH07AVFJ RIWH09AVFJ RIWH12AVFJ RIWH15AVFJ	250 V, 3.15 A	Activate: 221 ±18 °F (105 ±10 °C) Fan motor stop Reset: 194 ±18 °F (90 ±10 °C) Fan motor restart	—	—
	RIWH18AVFJ RIWH24AVFJ		Activate: 302 ±27 °F (150 ±15 °C) Fan motor stop Reset: 248 ±27 °F (120 ±15 °C) Fan motor restart	Activate: 216 °F (102 °C)	—

\*: Printed Circuit Board

## 10. External input and output

Indoor unit type	External input	External output	
	Control input	Operation status output	Error status output
Wall mounted	•	•	• (RIWH07/09/12/15AVFJ)

### 10-1. External input

With using external input function, some functions on this product can be controlled from an external device.

- “Operation/Stop” mode or "Forced stop" mode can be selected with function setting of indoor unit.
- A twisted pair cable (22AWG) should be used. Maximum length of cable is 492 ft (150 m).
- The wire connection should be separate from the power cable line.

#### ■ Control input (Operation/Stop or Forced stop)

Indoor unit type	Connector
Wall mounted RIWH07AVFJ, RIWH09AVFJ, RIWH12AVFJ, RIWH15AVFJ	CNA01
RIWH18AVFJ, RIWH24AVFJ	CN14

The air conditioner can be remotely operated by means of the following on-site work.

Operation is started at the following contents by adding the contact input of a commercial on/off switch to a connector on the external control PCB and turning it on.

Unit operation	Initial setting after power is on	Starting mode other than initial setting
Operation mode	Auto changeover	Mode at previous operation
Set temperature	76 °F (24 °C)	Temperature at previous operation
Airflow mode	AUTO	Mode at previous operation
Air direction (swing)	Standard air direction (swing: off)	Air direction at previous operation

#### ● Circuit diagram example

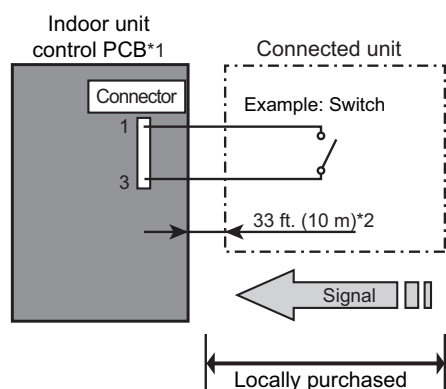

- Contact capacity: DC 24 V or more, 10 mA or more.
- \*1: PCB of Communication kit is used for wall mounted (RIWH07AVFJ, RIWH09AVFJ, RIWH12AVFJ, and RIWH15AVFJ) type.
- \*2: Make the distance from the PCB to the connected unit within 33 ft (10 m).
- Use non-polar relays and switches.

Indoor unit type	1-pin (Polarity)	3-pin (Polarity)
Wall mounted RIWH07AVFJ, RIWH09AVFJ, RIWH12AVFJ, RIWH15AVFJ, RIWH18AVFJ, RIWH24AVFJ	-	+

- When function setting is "Operation/Stop" mode

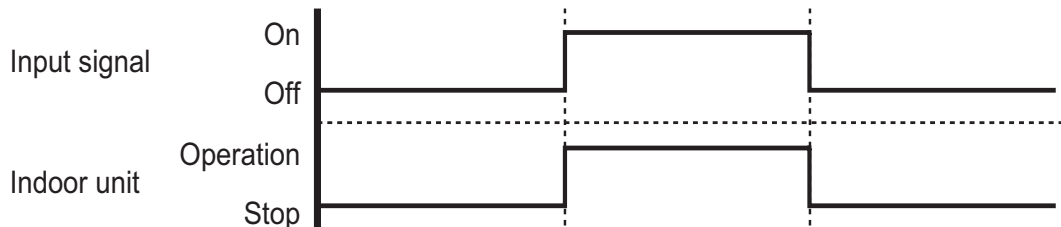

- When function setting is "Forced stop" mode

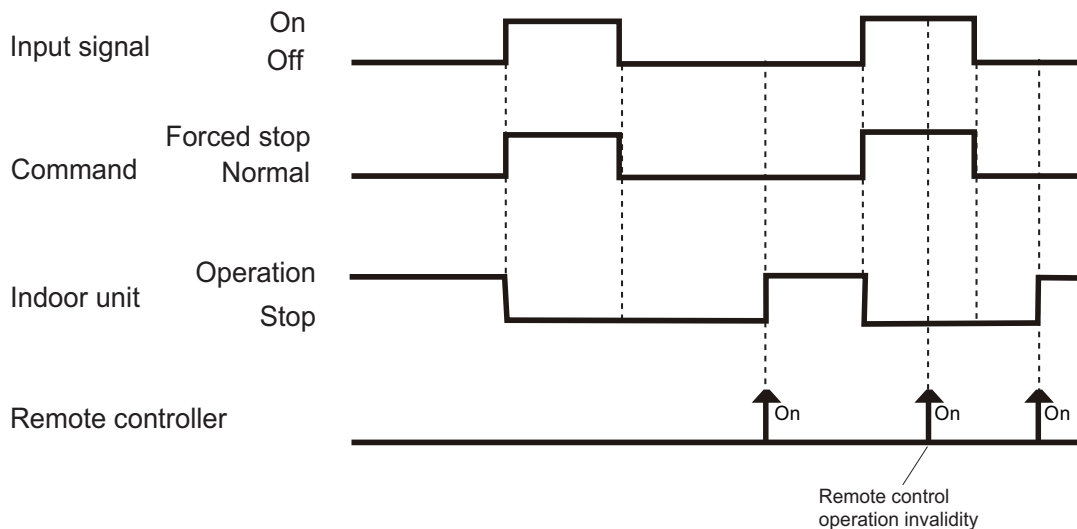

## ● Optional part

Indoor unit type		Part name	Model name
Wall mounted	RIWH07AVFJ, RIWH09AVFJ, RIWH12AVFJ, RIWH15AVFJ	External connect kit	RXXWZXZ5
	RIWH18AVFJ, RIWH24AVFJ		RXXWZX

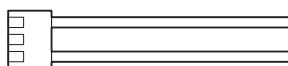

Indoor unit type		Part name	Model name
Wall mounted	RIWH07AVFJ, RIWH09AVFJ, RIWH12AVFJ, RIWH15AVFJ	Communication kit	RXXCBXZ2
	RIWH18AVFJ, RIWH24AVFJ	—	—

\*For operating the external input function, the wall mounted (RIWH07AVFJ, RIWH09AVFJ, RIWH12AVFJ, and RIWH15AVFJ) type requires optional communication kit (RXXCBXZ2) in addition to the wire (RXXWZXZ5).

## 10-2. External output

Use an external output cable with appropriate external dimension, depending on the number of cables to be installed.

### ■ Operation status output

	Indoor unit type	Connector
Wall mounted	RIWH07AVFJ, RIWH09AVFJ, RIWH12AVFJ, RIWH15AVFJ	CNB01
	RIWH18AVFJ, RIWH24AVFJ	CN16

Air conditioner operation status signal can be output.

### ● Circuit diagram example

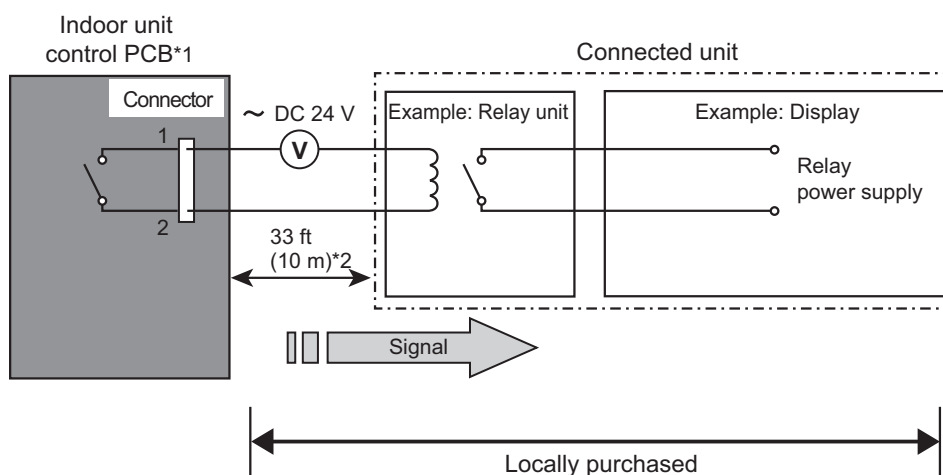

- \*1: PCB of Communication kit is used for wall mounted (RIWH07AVFJ, RIWH09AVFJ, RIWH12AVFJ, and RIWH15AVFJ) type.
- \*2: Make the distance from the PCB to the connected unit within 33 ft (10 m).
- Relay spec: Max. DC 24 V, 10 mA to less than 500 mA.

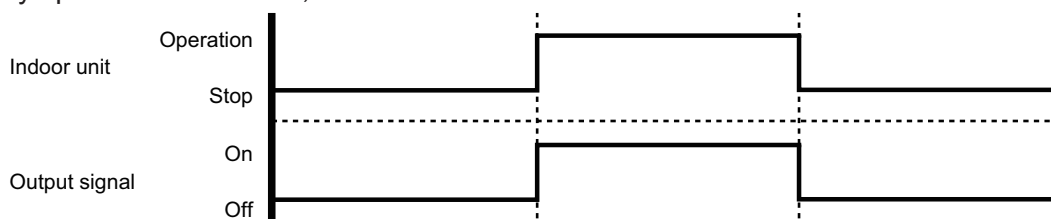

## ● Optional part

Indoor unit type		Part name	Model name
Wall mounted	RIWH07AVFJ, RIWH09AVFJ, RIWH12AVFJ, RIWH15AVFJ	External connect kit	RXXWZXZ5
	RIWH18AVFJ, RIWH24AVFJ		RXXWZX

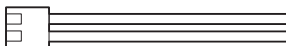

Indoor unit type		Part name	Model name
Wall mounted	RIWH07AVFJ, RIWH09AVFJ, RIWH12AVFJ, RIWH15AVFJ	Communication kit	RXXCBXZ2
	RIWH18AVFJ, RIWH24AVFJ	—	—

\*For operating the external output function, the wall mounted type (RIWH07AVFJ, RIWH09AVFJ, RIWH12AVFJ, and RIWH15AVFJ) requires optional Communication kit (RXXCBXZ2) in addition to the wire (RXXWZXZ5).

## ■ Error status output

Indoor unit type		Connector
Wall mounted	RIWH07AVFJ, RIWH09AVFJ, RIWH12AVFJ, RIWH15AVFJ	CNB02
	RIWH18AVFJ, RIWH24AVFJ	—

Air conditioner error status signal can be output.

### ● Circuit diagram example

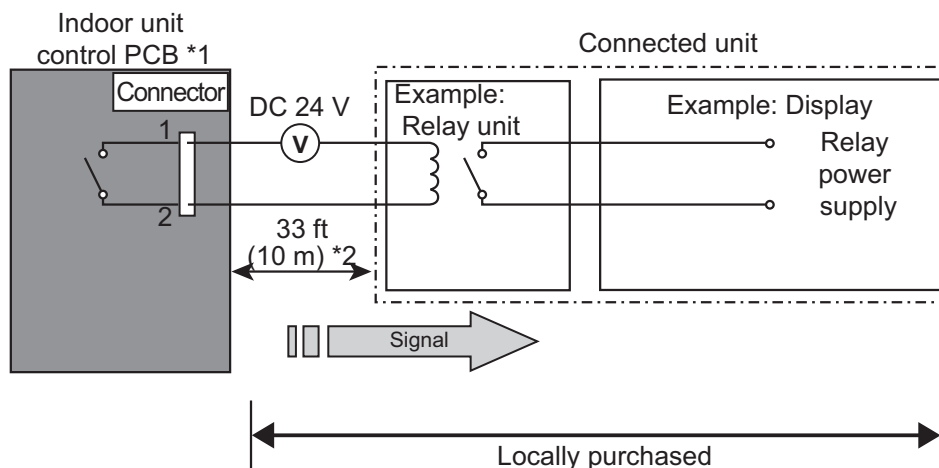

- \*1: PCB of Communication kit is used for wall mounted (RIWH07AVFJ, RIWH09AVFJ, RIWH12AVFJ, and RIWH15AVFJ) type.
- \*2: Make the distance from the PCB to the connected unit within 33 ft (10 m).
- Relay spec.: Max. DC 24 V, 10 mA to less than 500 mA.

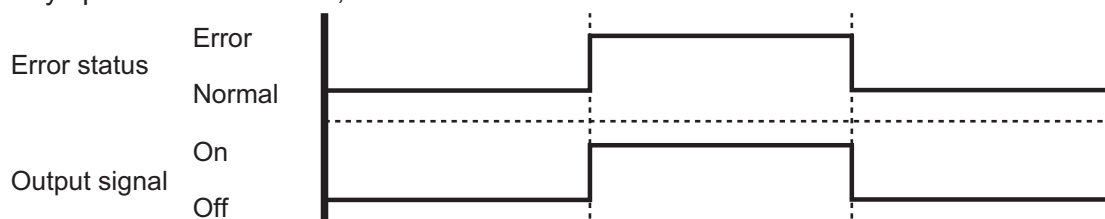

### ● Optional part

Indoor unit type	Part name	Model name
Wall mounted	RIWH07AVFJ, RIWH09AVFJ, RIWH12AVFJ, RIWH15AVFJ	External connect kit
	RIWH18AVFJ, RIWH24AVFJ	—

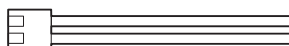

Indoor unit type	Part name	Model name
Wall mounted	RIWH07AVFJ, RIWH09AVFJ, RIWH12AVFJ, RIWH15AVFJ	Communication kit
	RIWH18AVFJ, RIWH24AVFJ	—

\*For operating the external input function, the wall mounted (RIWH07AVFJ, RIWH09AVFJ, RIWH12AVFJ, and RIWH15AVFJ) type requires Communication kit (RXXCBXZ2) in addition to the wire (RXXWZXZ5).

# 11. Remote controller

## 11-1. Wireless remote controller (AR-RAH2U)

### Overview

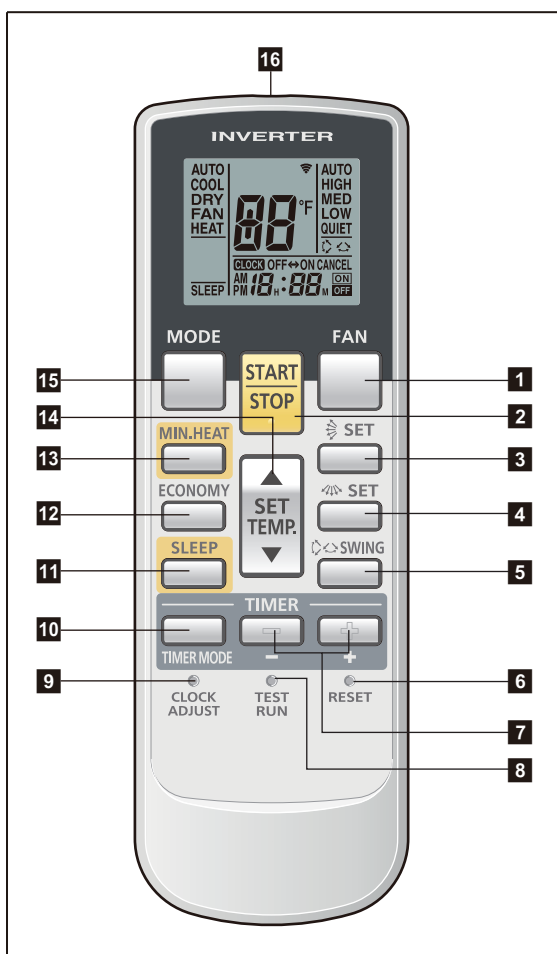

Display panel

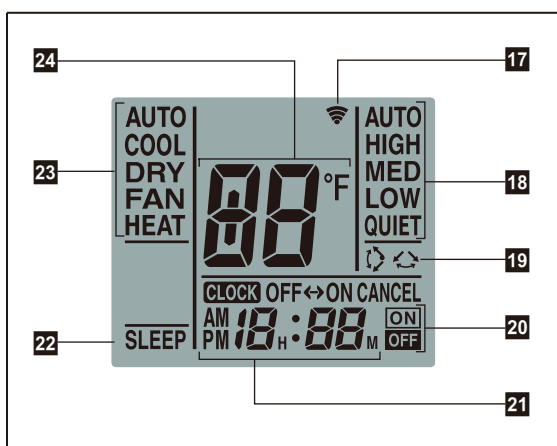

**NOTE:** Functions may differ by type of the indoor unit. For details, refer to the operation manual.

- 1 FAN button**  
Selects the fan speed (AUTO, HIGH, MED, LOW, and QUIET).
- 2 START/STOP button**  
Starts and stops operation.
- 3 SET button (vertical)**  
Adjusts the vertical airflow direction.
- 4 SET button (horizontal)**  
Adjusts the horizontal airflow direction.
- 5 SWING button**  
Sets the automatic swing operation and selects swing mode (Up/down, Left/right, Up/down/left/right, and Stop swing).
- 6 RESET button**  
Used when replacing batteries.
- 7 Timer set (- / +) button**  
Sets the current time and on-off time.
- 8 TEST RUN button**  
Only used for the initial test in the unit installation.
- 9 CLOCK ADJUST button**  
Used for adjusting the clock.
- 10 TIMER MODE button**  
Selects the timer mode (off timer, on timer, program timer, and timer reset).
- 11 SLEEP button**  
Pressed to select sleep timer.
- 12 ECONOMY button**
- 13 MIN. HEAT button**
- 14 SET TEMP. (temperature) (▲ / ▼) button**
  - Sets desired temperature.
  - Sets remote controller custom code.
- 15 MODE button**
  - Switches operation mode (AUTO, COOL, DRY, FAN, and HEAT).
  - Starts/ends the remote controller custom code (max. 4 types) change.
- 16 Signal transmitter**
- 17 Signal transmit indicator**
- 18 Fan speed indicator**
- 19 Swing indicator**
- 20 Timer mode indicator**
- 21 Clock indicator**
- 22 Sleep indicator**
- 23 Operating mode indicator**
- 24 Temperature indicator**

## ■ Specifications

### ● Controller

Unit: in (mm)

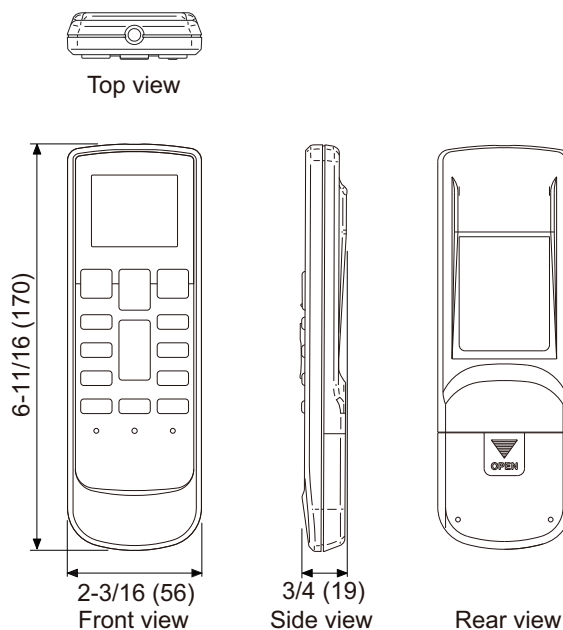

Size (H × W × D)	in (mm)	6-11/16 × 2-3/16 × 3/4 (170 × 56 × 19)
Weight	oz (g)	3 (85) (without batteries)

**NOTE:** Actual number of buttons might be different from the figure above.

### ● Holder

Unit: in (mm)

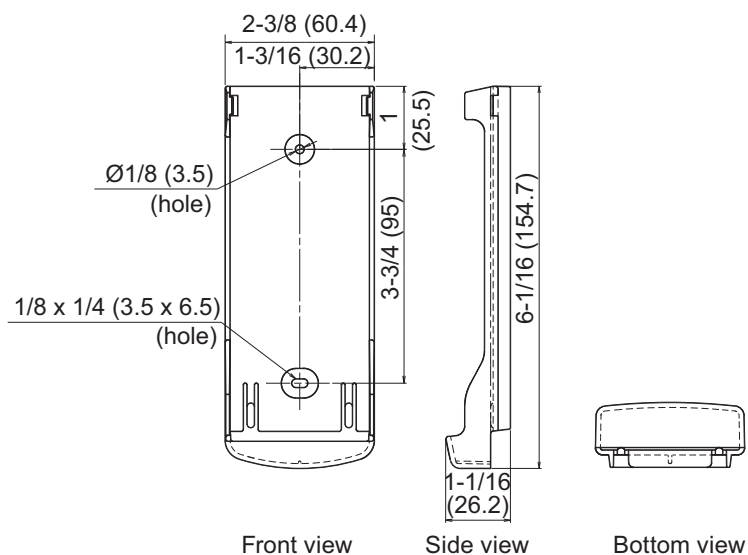

Size (H × W × D)	in (mm)	6-1/16 × 2-3/8 × 1-1/16 (154.7 × 60.4 × 26.2)
Weight	oz (g)	10 (28)



# 11-2. Wireless remote controller (AR-REG1U)

## Overview

### AR-REG1U

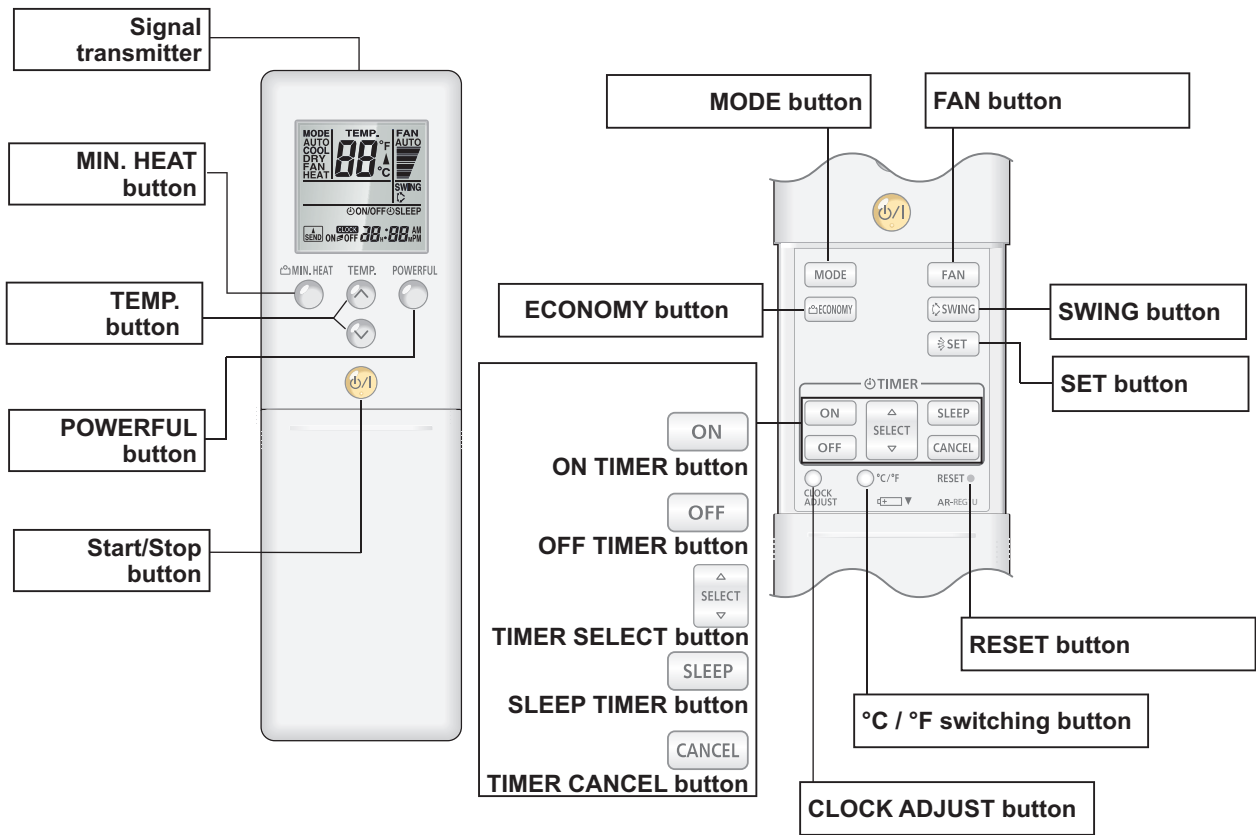

**NOTE:** Functions may differ by type of the indoor unit. For details, refer to the operation manual.

### Display panel

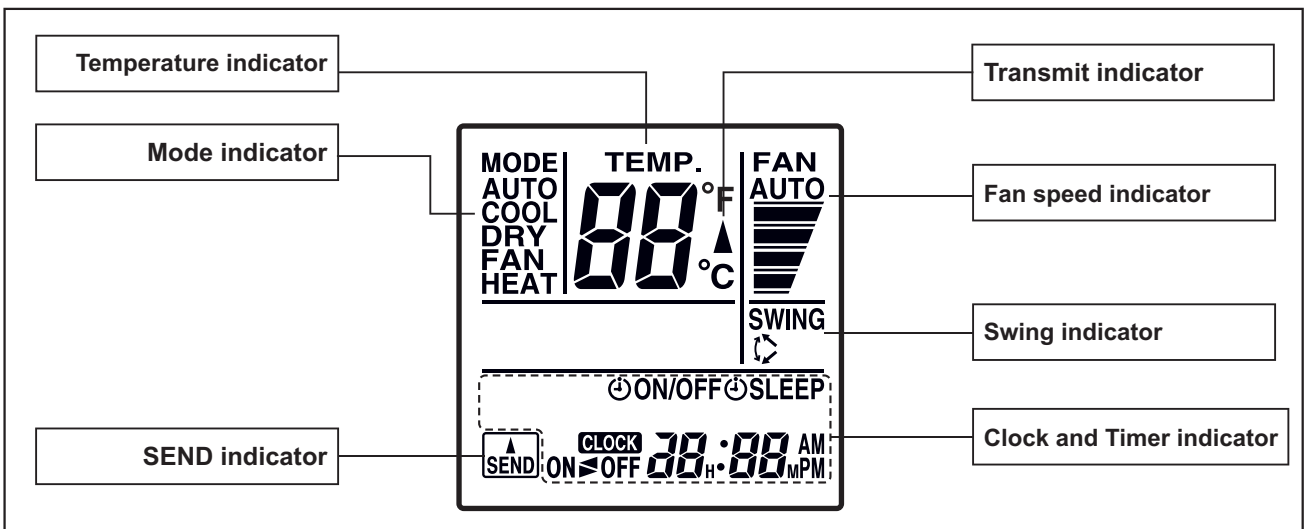

To facilitate explanation, the accompanying illustration has been drawn to show all possible indicators; in actual operation, however, the display will only show those indicators appropriate to the current operation.

## ■ Specifications

### ● Controller

Unit: in (mm)

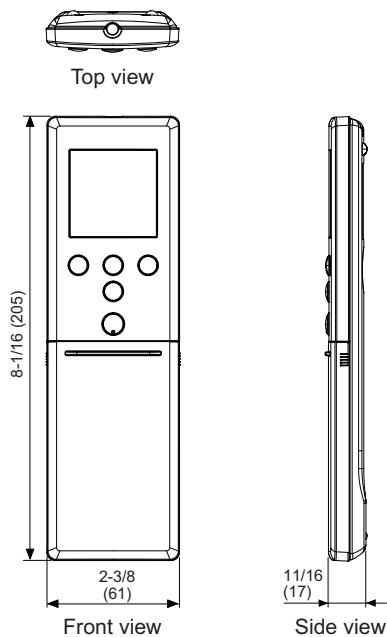

Size (H × W × D)	in (mm)	8-1/16 × 2-3/8 × 11/16 (205 × 61 × 17)
Weight	oz (g)	4.3 (122) (without batteries)

### ● Holder

Unit: in (mm)

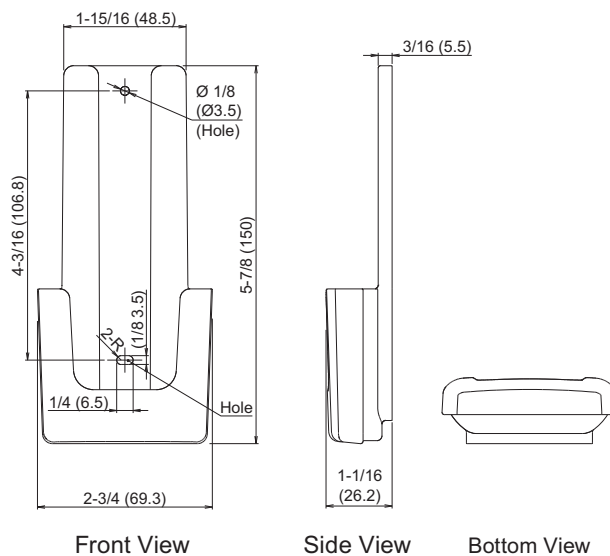

Size (H × W × D)	in (mm)	5-7/8 × 2-3/4 × 1-1/16 (150 × 69.3 × 26.2)
Weight	oz (g)	1 (27)

# 11-3. Wired remote controller (RXRNNUM: Optional part)



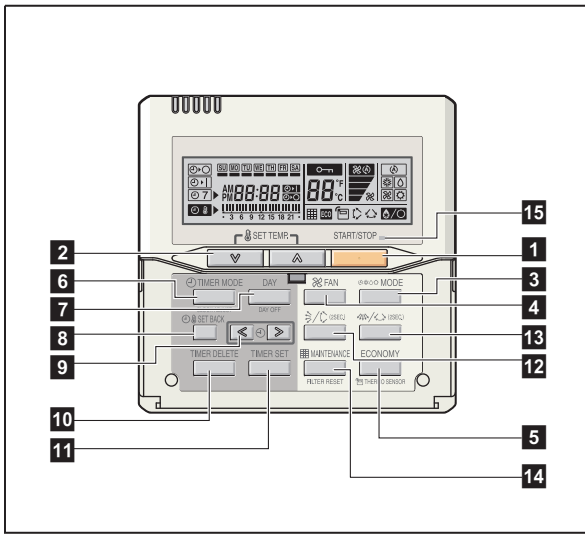



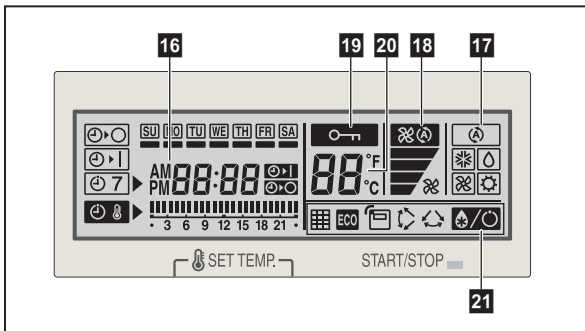









## Overview



Display panel



**NOTE:** Functions may differ by type of the indoor unit. For details, refer to the operation manual.

- 1 START/STOP button**  
Starts and stops operation.
- 2 SET TEMP. button**  
Selects the setting temperature.
- 3 MODE button**  
Selects the operating mode (AUTO , HEAT , FAN , COOL , and DRY ).
- 4 FAN button**  
Selects the fan speed AUTO , QUIET , LOW , MED , and HIGH .
- 5 ECONOMY (THERMO SENSOR) button**  
Turns the economy-efficient mode on and off.
- 6 TIMER MODE (CLOCK ADJUST) button**  
Selects the timer mode (off timer, on timer, and weekly timer). Sets the current time.
- 7 DAY (DAY OFF) button**  
Temporarily cancels one day timer.
- 8 SET BACK button**  
Selects the set back timer.
- 9 Set time button**  
Pressed to set time.
- 10 TIMER DELETE button**  
Deletes the weekly timer schedule.
- 11 TIMER SET button**  
Sets the date, hour, minute, and on-off time.
- 12 Vertical airflow direction and swing button**  
Push for 2 seconds to change the swing mode.
- 13 Horizontal airflow direction and swing button**  
Push for 2 seconds to change the swing mode.
- 14 FILTER RESET button**
- 15 Operation lamp**  
Lights during operation and when the timer is on.
- 16 Timer and clock indicator**
- 17 Operation mode indicator**
- 18 Fan speed indicator**
- 19 Operation lock indicator**
- 20 Temperature indicator**
- 21 Function indicators**
  -  Defrost indicator
  -  Thermo sensor indicator
  -  Economy indicator
  -  Vertical swing indicator
  -  Horizontal swing indicator
  -  Filter indicator

## ■ System diagram

1 remote controller:

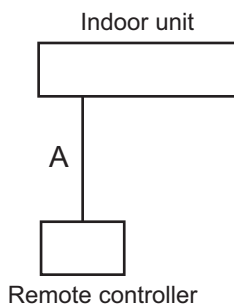

2 remote controllers:

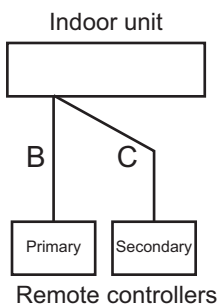

A, B, C: Remote controller cable  
 $A \leq 1,640 \text{ ft (500 m)}$ ;  $B + C \leq 1,640 \text{ ft (500 m)}$

## ■ Electrical wiring

1 remote controller:

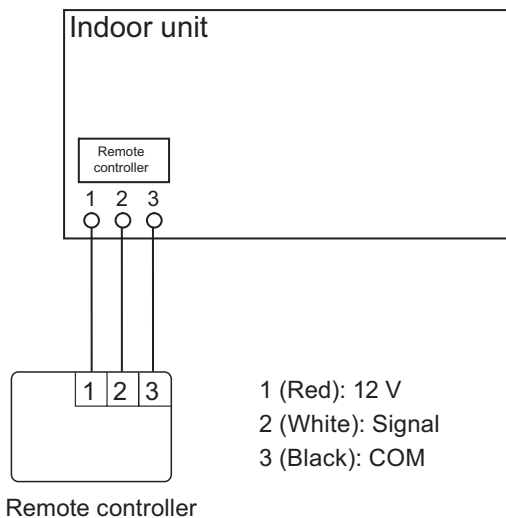

1 (Red): 12 V  
 2 (White): Signal  
 3 (Black): COM

2 remote controllers:

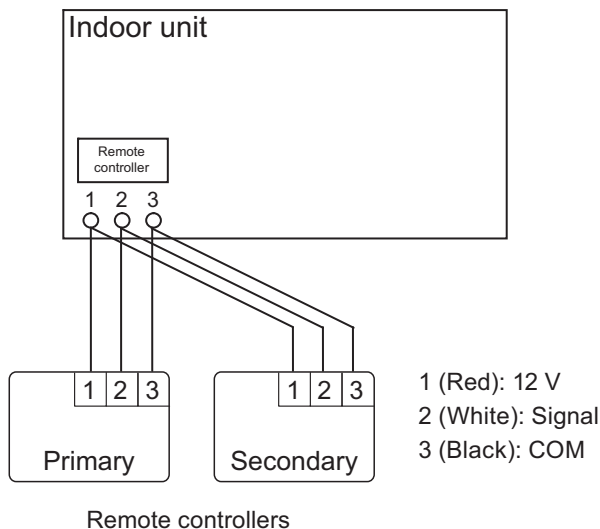

1 (Red): 12 V  
 2 (White): Signal  
 3 (Black): COM

## ■ Specifications

Dimensions and other specifications on the wired remote controller are as follows.

Unit: in (mm)

The drawing shows two views of the remote controller. The front view is a rectangular device with a width of 4-3/4 (120) and a height of 4-3/4 (120). It features a digital display at the top showing '88:88' and various control buttons below, including 'TIMER MODE', 'DAY', 'FAN', 'MODE', 'SET BACK', 'TIMER DELETE', 'TIMER SET', 'MAINTENANCE', 'ECONOMY', 'FILTER RESET', and 'THERMO SENSOR'. The side view shows a thickness of 11/16 (18) and a height of 4-3/4 (120).

Size (H × W × D)	in (mm)	4-3/4 × 4-3/4 × 11/16 (120 × 120 × 18)
Weight	oz (g)	5.6 (160)
Cable length (accessory)	ft (m)	33 (10)
Power	V	12

## ● Wiring specifications

Use	Cable size	Wire type	Remarks
Remote controller cable	22 AWG (0.33 mm <sup>2</sup> )	Polar 3-core	Use sheathed PVC cable.

## ■ Installation

### ● Connection pattern

**NOTE:** Connection pattern is different according to type of Indoor unit.

	Indoor unit types	Connection pattern
Wall mounted type	RIWH07AVFJ, RIWH09AVFJ, RIWH12AVFJ, and RIWH15AVFJ	Pattern A
	RIWH18AVFJ and RIWH24AVFJ	Pattern B

### ● Pattern A

1. Modify the remote controller cable as follows:
  - Use a tool to cut off the terminal on the end of the remote controller cable and then remove the insulation from the cut end of the cable as shown in following figure.
  - Connect the remote controller cable and connecting cable as shown in following figure.
  - Be sure to insulate the connection between the cables.

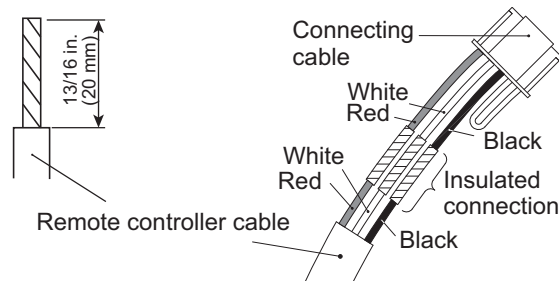

2. Connect the remote controller cable.
  - Connect the cable made in step 1. to the terminal (\*1) of optional communication kit.
  - Connect the cable from the terminal (\*2) of communication kit to the indoor unit PCB.

\*1: CNC01 (for RIWH07—15AVFJ: RXXCBXZ2)  
\*2: CND01 (for RIWH07—15AVFJ: RXXCBXZ2)

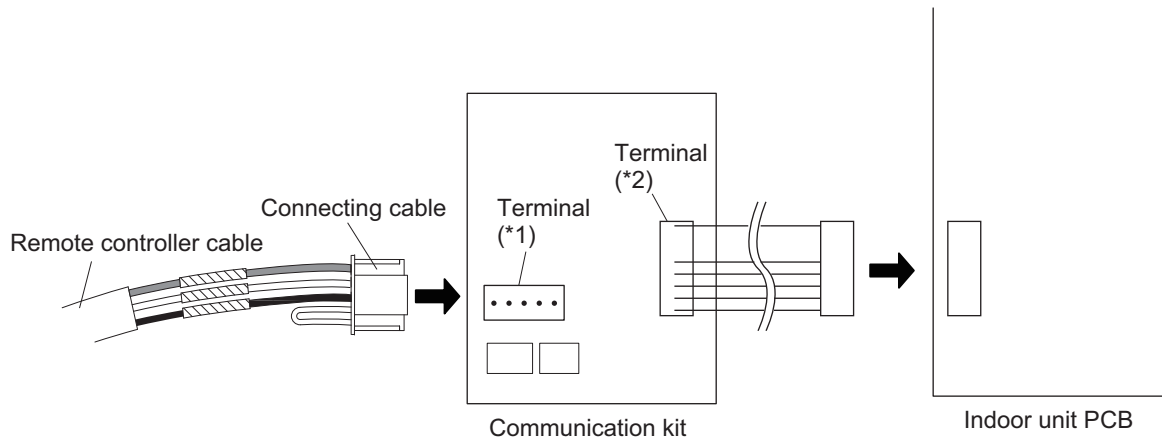

## ● Pattern B

1. Modify the remote controller cable as follows:
  - Use a tool to cut off the terminal on the end of the remote controller cable and then remove the insulation from the cut end of the cable as shown in following figure.
  - Connect the remote controller cable and connecting cable as shown in following figure.
  - Be sure to insulate the connection between the cables.

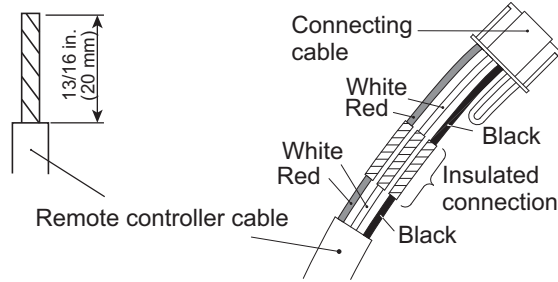

2. Connect the remote controller cable.
  - Connect the cable made in step 1. to the indoor unit PCB.

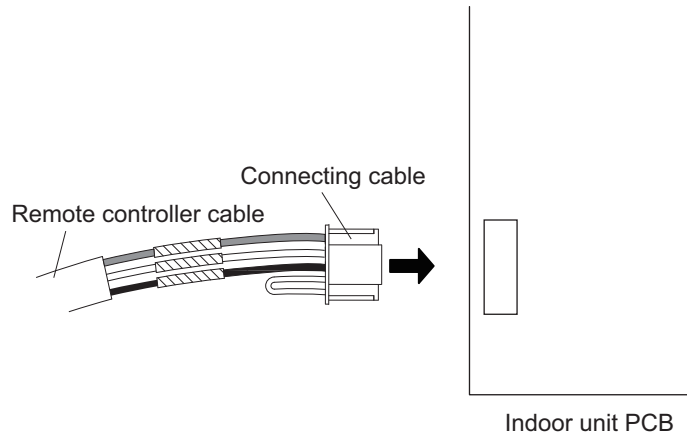

## ■ Optional parts

Wall mounted	Model name
RIWH07—15AVFJ	RXXCBXZ2

The communication kit is needed for connecting the wired remote controller to the wall mounted type.

## 11-4. Simple remote controller (RXRSNUM: Optional part)

### Overview

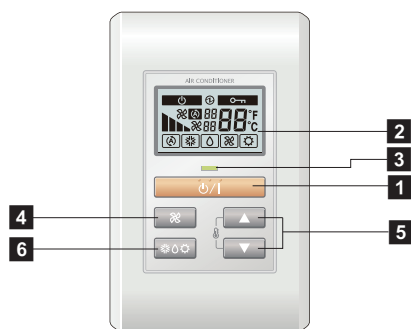

Display panel

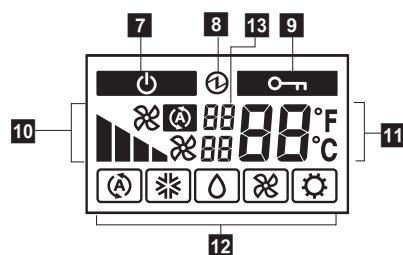

#### 1 START/STOP button

Starts and stops operation.





#### 2 Display backlight button

Lights during operation.

#### 3 Operation lamp

Lights during operation.





#### 4 FAN button

Selects the fan speed (AUTO , HIGH , MED , LOW , and QUIET .

#### 5 SET TEMP. button

Selects the setting temperature.

#### 6 MODE button

Selects the operating mode (AUTO , COOL , DRY , FAN , HEAT .

#### 7 Standby indicator

Indicates during the oil recovery and defrosting operation.

#### 8 Power source indicator

Indicates the main power is on.

#### 9 Central control indicator

Indicates when function is locked.

#### 10 Fan speed indicator

Deletes the weekly timer schedule.

#### 11 Set temperature

- Indicates error history number in error code history display mode.
- Indicates indoor unit address in address display mode.

#### 12 Operating mode indicator

#### 13 Indicator

- Upper:
  - Indicates the error code in error code history display mode and in self diagnosis mode.
  - Indicates the refrigerant system address in address display mode.
- Lower: Indicates the remote controller address in error code history display mode, address display mode, and self diagnosis mode.



## ■ System diagram

1 remote controller:

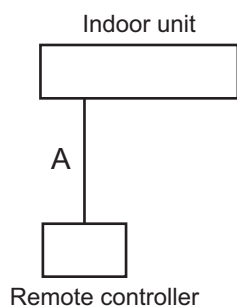

2 remote controllers:

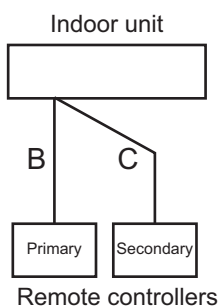

A, B, C: Remote controller cable  
 $A \leq 1,640 \text{ ft (500 m)}$ ;  $B + C \leq 1,640 \text{ ft (500 m)}$

## ■ Electrical wiring

1 remote controller:

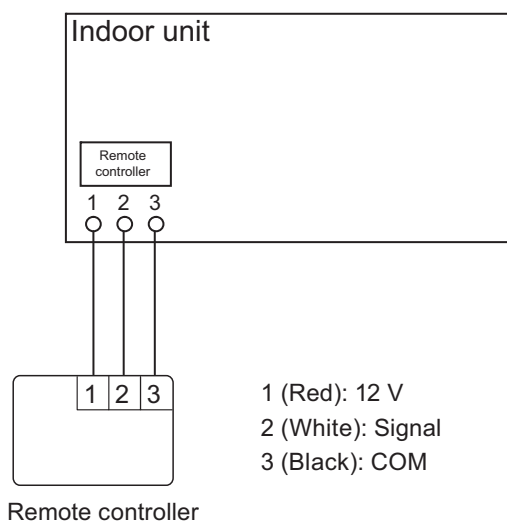

2 remote controllers:

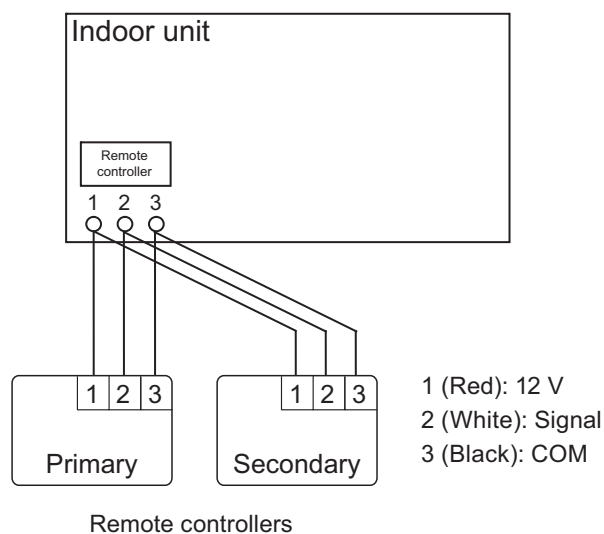

## ■ Specifications

Dimensions and other specifications on the wired remote controller are as follows.

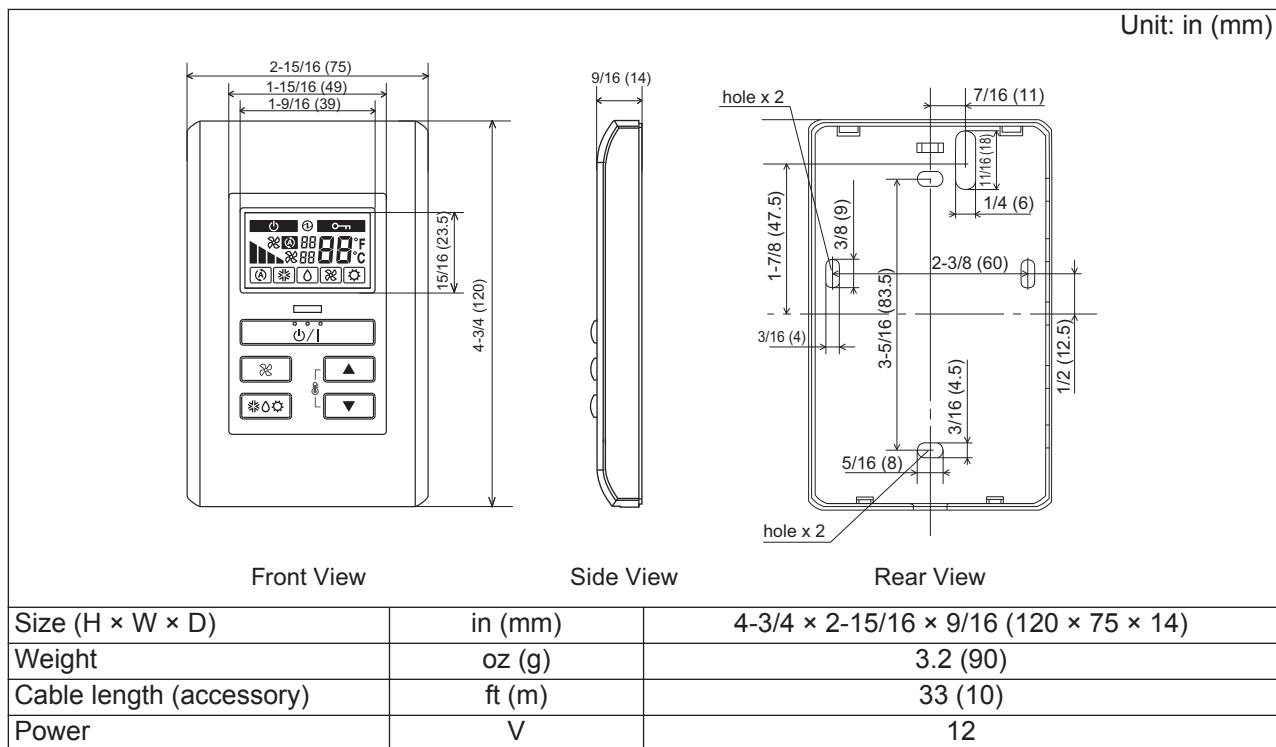

## ■ Wiring specifications

Use	Size	Wire type	Remarks
Remote controller cable	22 AWG (0.33 mm <sup>2</sup> )	Polar 3 core	Use sheathed PVC cable.

## ■ Installation

### ● Connection pattern

**NOTE:** Connection pattern is different according to type of Indoor unit.

Indoor unit types		Connection pattern
Wall mounted type	RIWH07AVFJ, RIWH09AVFJ, RIWH12AVFJ, and RIWH15AVFJ	Pattern A
	RIWH18AVFJ and RIWH24AVFJ	Pattern B

### ● Pattern A

- Modify the remote controller cable as follows:
  - Use a tool to cut off the terminal on the end of the remote controller cable and then remove the insulation from the cut end of the cable as shown in following figure.
  - Connect the remote controller cable and connecting cable as shown in following figure.
  - Be sure to insulate the connection between the cables.

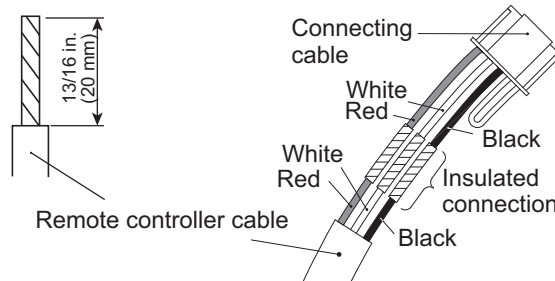

- Connect the remote controller cable.
  - Connect the cable made in step 1. to the terminal (\*1) of optional communication kit.
  - Connect the cable from the terminal (\*2) of communication kit to the indoor unit PCB.

- \*1: CNC01 (for RIWH07—15AVFJ: RXXCBXZ2)
- \*2: CND01 (for RIWH07—15AVFJ: RXXCBXZ2)

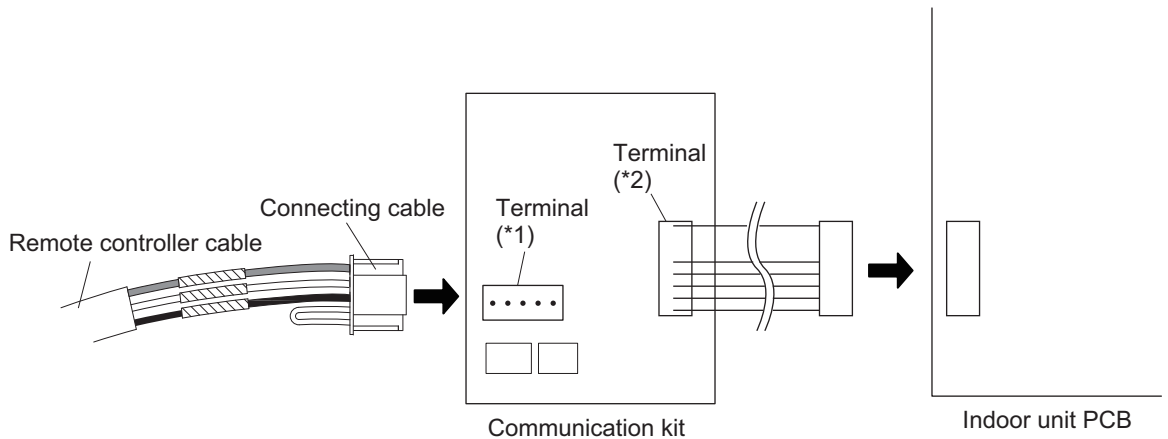

## ● Pattern B

1. Modify the remote controller cable as follows:
  - Use a tool to cut off the terminal on the end of the remote controller cable and then remove the insulation from the cut end of the cable as shown in following figure.
  - Connect the remote controller cable and connecting cable as shown in following figure.
  - Be sure to insulate the connection between the cables.

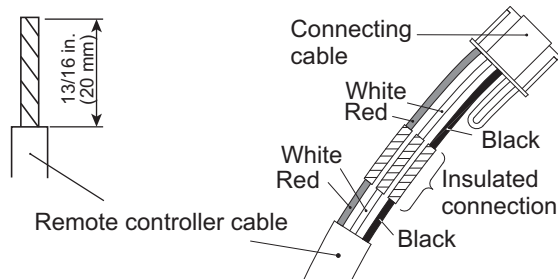

2. Connect the remote controller cable.
  - Connect the cable made in step 1. to the indoor unit PCB.

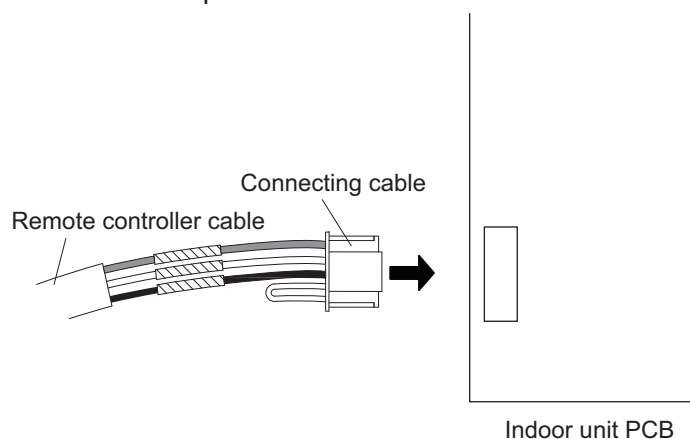

## ■ Optional parts

Wall mounted	Model name
RIWH07—15AVFJ	RXXCBXZ2

The communication kit is needed for connecting the wired remote controller to the wall mounted type.

## 12. Function settings

To adjust the functions of this product according to the installation environment, various types of function settings are available.

**NOTE:** Incorrect settings can cause a product malfunction.

### 12-1. Indoor unit (setting by wireless remote controller)

- The function settings of the control of the indoor unit can be changed by this procedure according to the installation conditions. Incorrect settings can cause the indoor unit malfunction.
- After the power is turned on, perform the “Function setting” according to the installation conditions using the remote controller.
- The settings may be selected between the following two: Function number or Setting number.
- Settings will not be changed if invalid numbers or setting numbers are selected.

#### ■ Preparation

Before connecting the power supply of the indoor unit, reconfirm following items:

- Piping air tight test and vacuuming have been performed firmly.
- There is no wiring mistake. Then, connect the power supply of the indoor unit.

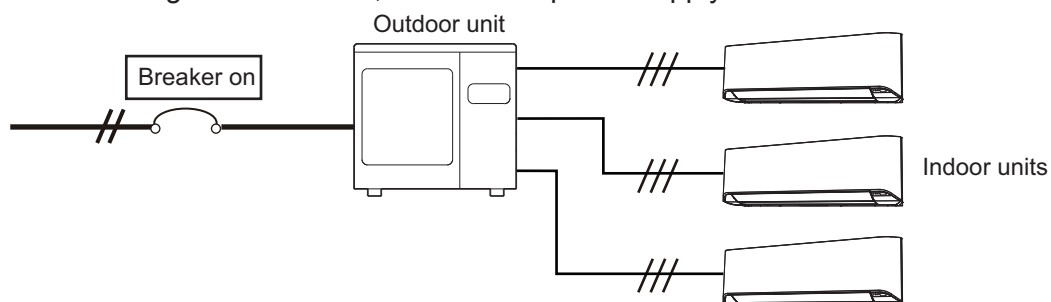

## ■ AR-RAH2U

### ● Button name and function

During address setting mode, indoor unit reject the any operation command from remote controller.

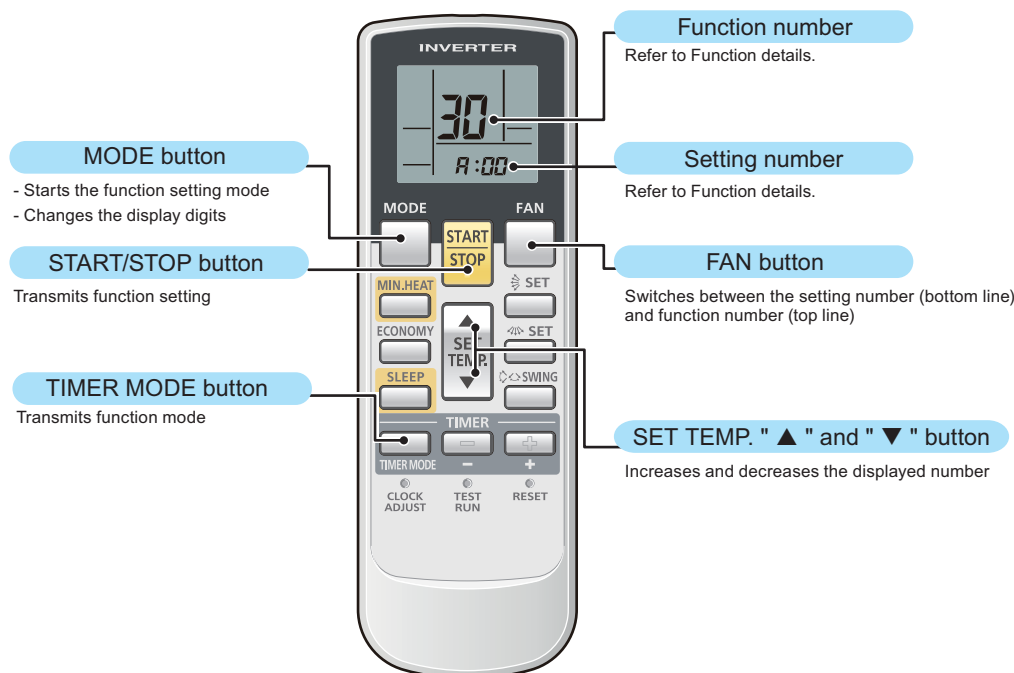

**NOTE:** Actual number of buttons might be different from the figures in following instructions.

### ● Function setting procedure

1. Connect the power supply of the outdoor unit.
2. To enter the function setting mode, while holding down the FAN and the SET TEMP. ▲ buttons, press the RESET button.

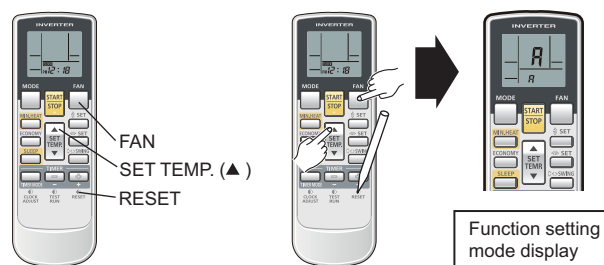

3. Press the SET TEMP. ▲ or ▼ buttons to select the custom code that matches the setting with the indoor unit. By selecting the appropriate custom code, the communication between the indoor unit and the wireless remote controller become possible.

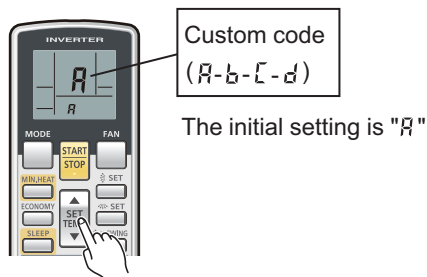

- For confirming the custom code, press the TIMER MODE button to send the code to the indoor unit.

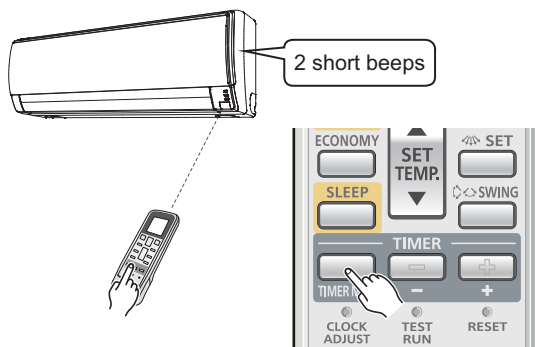

- Press the MODE button to enter the function setting mode.

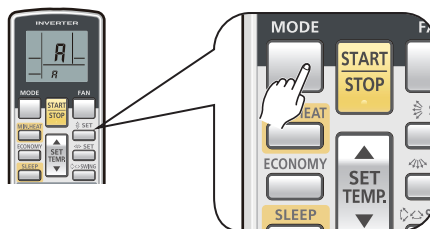

- Select the function number by pressing the ▲ or the ▼ button. Each time the MODE button is pressed, it switches between the left digit and the right digit.

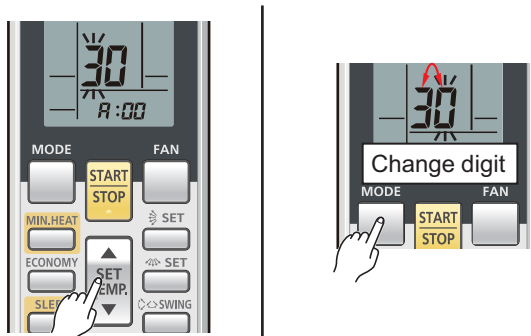

- Proceed to number setting by pressing the FAN button. To return to the function number selection, press the FAN button again.



- Select the setting number by pressing the ▲ or the ▼ button. Each time the MODE button is pressed, it switches between the left digit and the right digit.

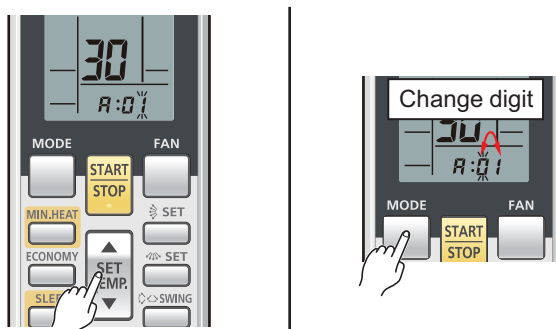

9. Send the function mode information by pressing the TIMER MODE button once.

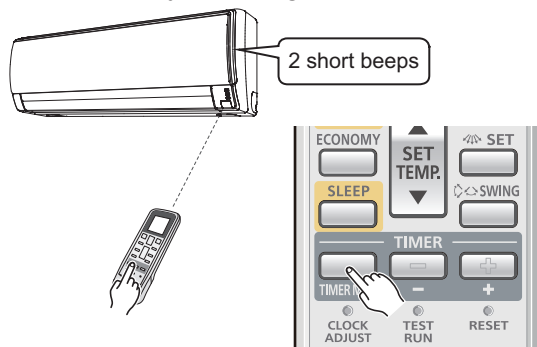

10. Send the function setting information by pressing the START/STOP button once. 2 short beeps will be emitted from the indoor unit when the signal is received correctly. If wrong code is set, no beep sound will be emitted.

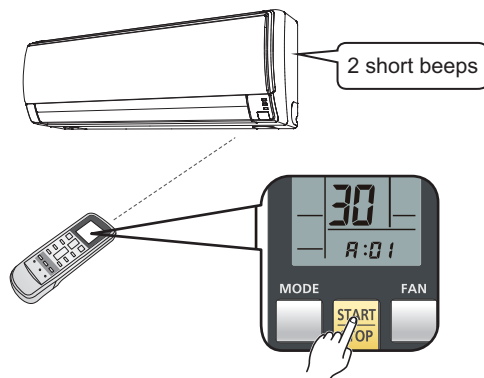

**NOTE:** Press START/STOP button within 30 seconds after pressing TIMER MODE button.

Function details: Refer to Chapter 12-4. "[Function details](#)" on page 67.

11. Exit the function setting mode by pressing the RESET button.

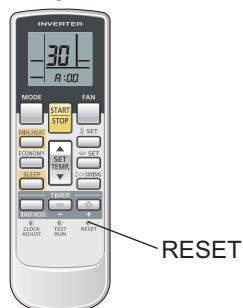

To set custom code *b*, *c*, or *d*, perform same procedures for each code.

## ● Setting up each indoor unit

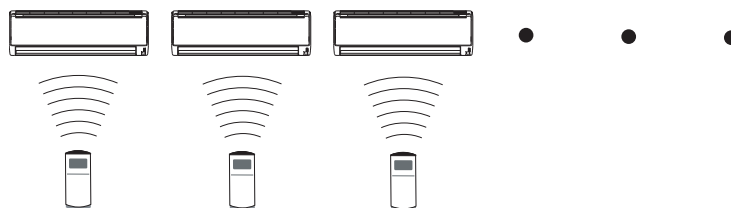

Repeat step from 1. to 11. to set up each indoor unit. If the custom code is other than "A", steps from 1. to 4. and 11. need to be performed.



## ● Resetting the power after setting up function of all indoor units

### NOTES:

- If the reset is not performed, function can not be read correctly.
- After all the functions have been set, the circuit breaker needs to be switched off for at least 2 minutes.
  - After the 2 minutes has passed, power can be restored.
  - The set function is stored in the PCB and will remain in memory even when the power of indoor unit is turned off.  
However setting function is effective after disconnecting the power supply and then reconnecting it.
- Record the latest configuration of the indoor unit function setting on a label, and put the label on the unit so it can be used for after-sales service operations.

Once the RESET button is pressed on the remote controller, the operation mode will be set to the AUTO MODE.

Adjust the operation mode to either cooling or heating before starting the operation of the air conditioner.

**NOTE:** If custom code other than "1" is set, the remote control must be set accordingly to the indoor unit setting.

## ● Remote controller custom code setting

Custom code setting of wireless remote controller needs to be same as the setting of the indoor unit. When you change the custom code setting of the wireless remote controller, do as follows:

1. Press the START/STOP button until only the clock is displayed on the remote controller display.

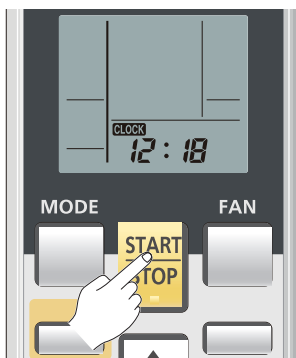

2. Press the MODE button for at least 5 seconds to display the current custom code (initially set to A).

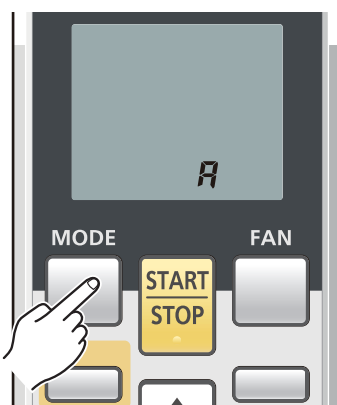

3. Press the SET TEMP. ▲ or the ▼ button to change the custom code between A → b → c → d.

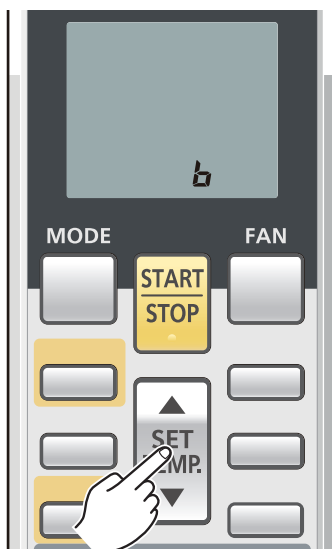

4. Press the MODE button again to return to the clock display. The custom code will be changed.

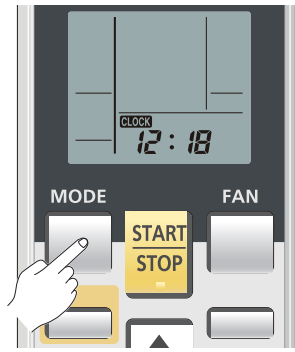

- If no buttons are pressed within 30 seconds after the custom code is displayed, the system returns to the original clock display. In this case, start again from step 1.
- The air conditioner custom code is set to A prior to shipment.
- The remote controller resets to custom code A when the batteries in the remote controller are replaced. If you use a custom code other than custom code A, reset the custom code after replacing the batteries. If you do not know the air conditioner custom code setting, try each of the custom codes (A → B → C → D) until you find the code which operates the air conditioner.

## ■ AR-REG1U

### ● Button name and function

During address setting mode, indoor unit reject the any operation command from remote controller.

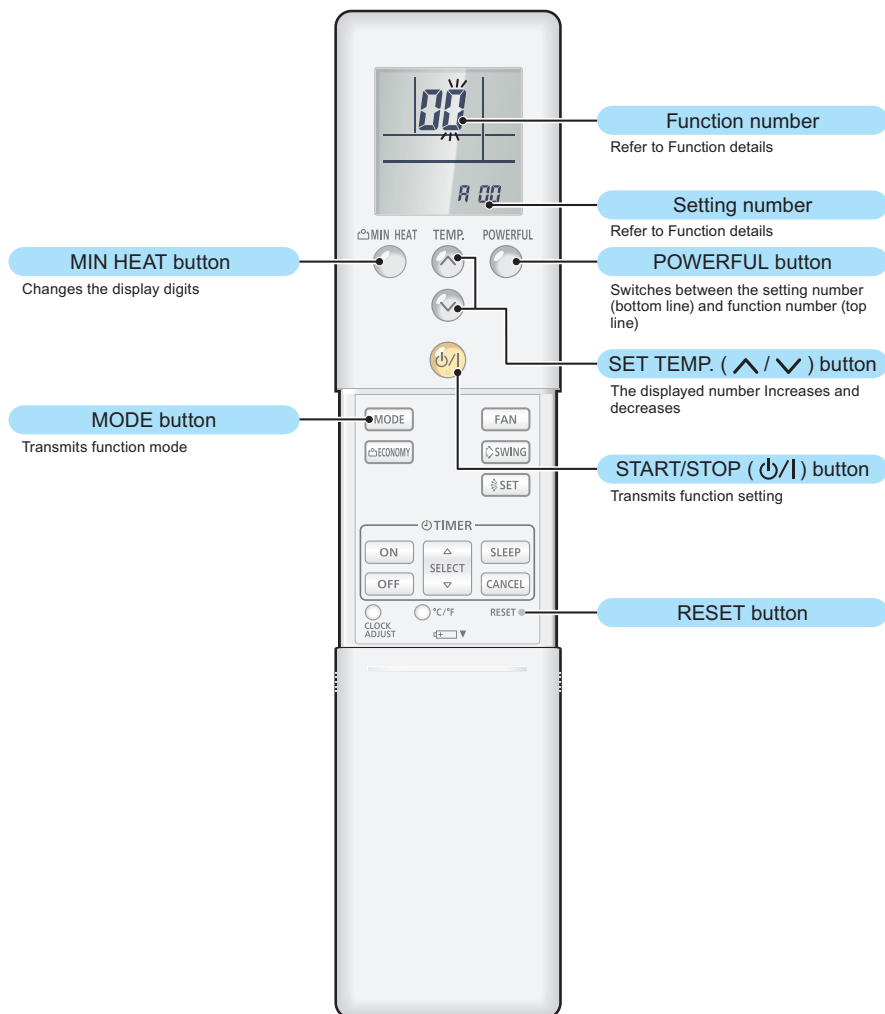

### ● Function setting procedure

1. Connect the power supply of the outdoor unit.
2. To enter the function setting mode, while holding down the POWERFUL and SET TEMP. ^ buttons, press the RESET button.

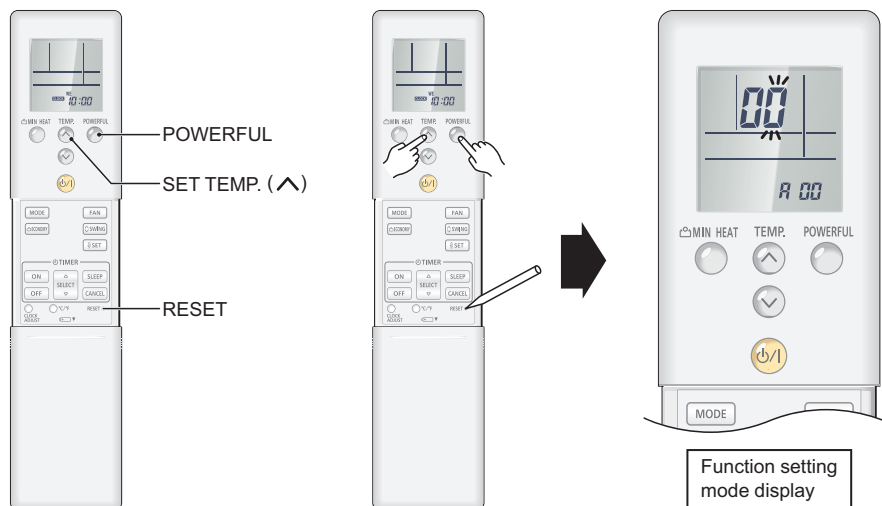

3. Select the function number by pressing the  $\wedge$  or the  $\nabla$  buttons. Each time the 10°C HEAT button is pressed, it switches between the right digit and the left digit.



4. Proceed to the setting number by pressing the POWERFUL button. (To return to the function number selection, press the POWERFUL button again.)



5. Select the function number by pressing the  $\wedge$  or the  $\nabla$  button. Each time the 10°C HEAT button is pressed, it switches between the right digit and the left digit.

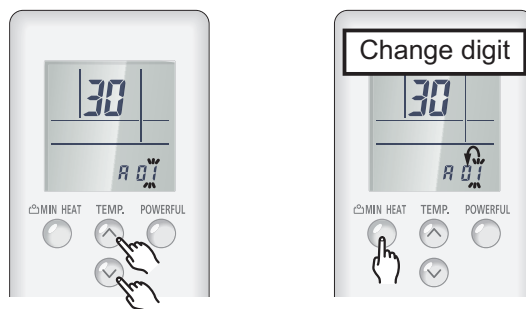

6. Press the MODE button once to transmit the function mode information.

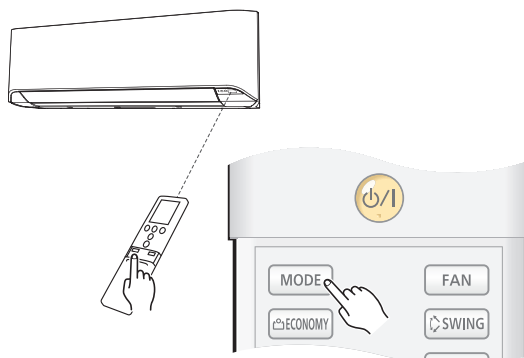

- Press the  $\phi/|$  button once to transmit the function setting information. 2 short beeps will be emitted from the indoor unit when the signal is received correctly. If wrong code is set, no beep sound will be emitted.

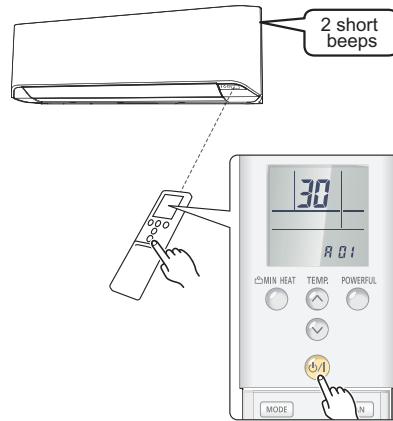

**NOTE:** Press  $\phi/|$  button within 30 seconds after pressing MODE button.

For the function details, refer to Chapter 12-4. "[Function details](#)" on page 67.

- Exit the function setting mode by pressing the RESET button.



## ● Setting up each indoor unit

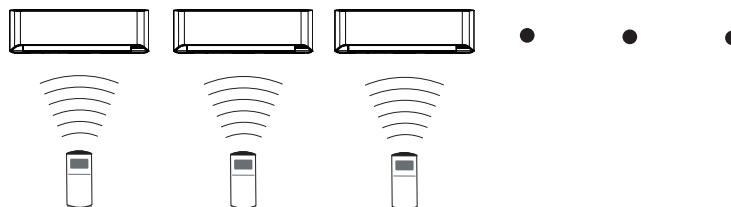

Repeat step from 1. to 8. to set up each indoor unit. If the custom code is other than "H", steps from 1. to 2. and 8. need to be performed.

## ● Resetting the power after setting up function of all indoor units

### NOTES:

- If the reset is not performed, function can not be read correctly.
- After all the functions have been set, the circuit breaker needs to be switched off for at least 2 minutes.
  - After the 2 minutes has passed, power can be restored.
  - The set function is stored in the PCB and will remain in memory even when the power of indoor unit is turned off.
 

However setting function is effective after disconnecting the power supply and then reconnecting it.
- Record the latest configuration of the indoor unit function setting on a label, and put the label on the unit so it can be used for after-sales service operations.

Once the RESET button is pressed on the remote controller, the operation mode will be set to the AUTO MODE.

Adjust the operation mode to either cooling or heating before starting the operation of the air conditioner.

**NOTE:** If custom code other than "H" is set, the remote control must be set accordingly to the indoor unit setting.

## ● Remote controller custom code setting

Custom code setting of wireless remote controller needs to be same as the setting of the indoor unit. When you change the custom code setting of the wireless remote controller, do as follows:

1. Press the START/STOP button until only the clock is displayed on the display.



2. Press the MODE button for at least 5 seconds to display the current custom code (initially set to A).



3. Press the SET TEMP. “ ^ ” or the “ v ” button to change the custom code between A → b → c → d.



4. Press the MODE button again to return to the clock display. The custom code will be changed.



- If no buttons are pressed within 30 seconds after the custom code is displayed, the system returns to the original clock display. In this case, start again from step 1.
- The air conditioner custom code is set to A prior to shipment.
- If you do not know the air conditioner custom code setting, try each of the custom codes (A → b → c → d) until you find the code which operates the air conditioner.



## ● Remote controller temperature unit

To change the displayed temperature unit, press the "°C/°F" switching button to select the preferred temperature unit. (Factory setting is set to "°F".):

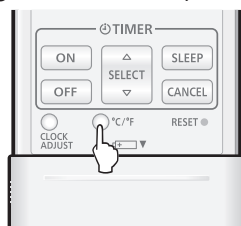

## 12-2. Indoor unit (setting by wired remote controller)

- The function settings of the control of the indoor unit can be changed by this procedure according to the installation conditions. Incorrect settings can cause the indoor unit malfunction.
- After the power is turned on, perform the “Function setting” according to the installation conditions using the remote controller.
- The settings may be selected between the following two: Function number or Setting number.
- Settings will not be changed if invalid numbers or setting numbers are selected.
- This function cannot be used on the secondary units.

### ■ Preparation

Before connecting the power supply of the indoor unit, reconfirm following items:

- Piping air tight test and vacuuming have been performed firmly.
- There is no wiring mistake. Then, connect the power supply of the indoor unit.

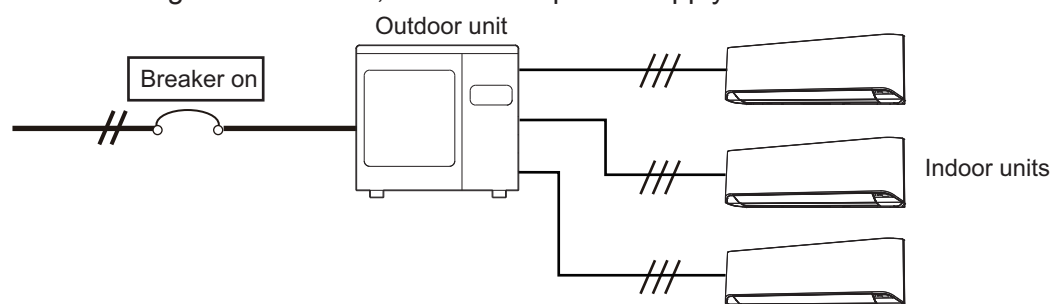

## ● Button name and function

During address setting mode, indoor unit reject the any operation command from remote controller.

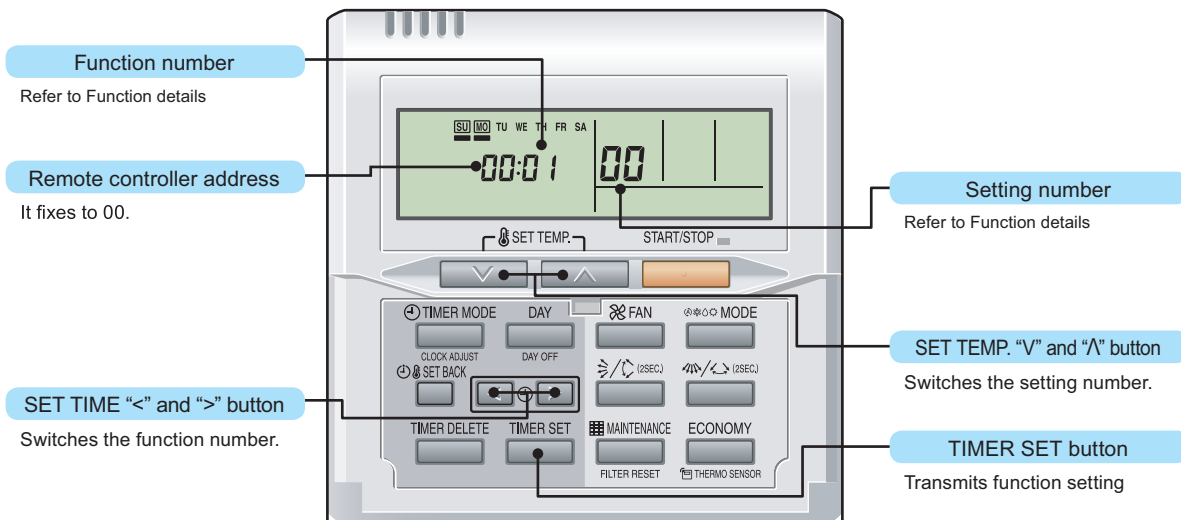

## ● Function setting procedure

1. Connect the power supply of the outdoor unit.
2. Switch to the function setting mode.

To enter the function setting mode, hold down the 3 buttons of SET TEMP.  $\nabla$ , SET TEMP.  $\wedge$ , and FAN at the same time for 5 seconds or longer.

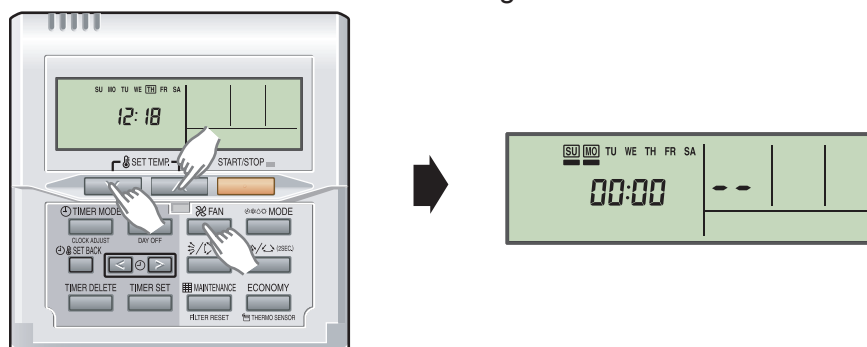

3. Select the function number by pressing the SET TIME < or the SET TIME > button.

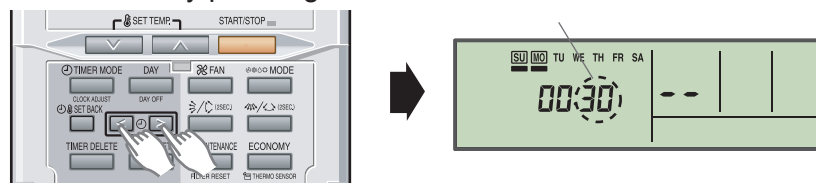

4. Select the setting number by pressing the SET TEMP.  $\wedge$  or the SET TEMP.  $\nabla$  button. The display flashes during setting number selection.

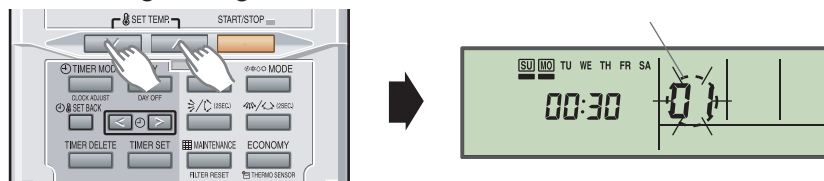

5. Confirm the setting by pressing the TIMER SET button.  
The data will be transferred to the indoor unit.

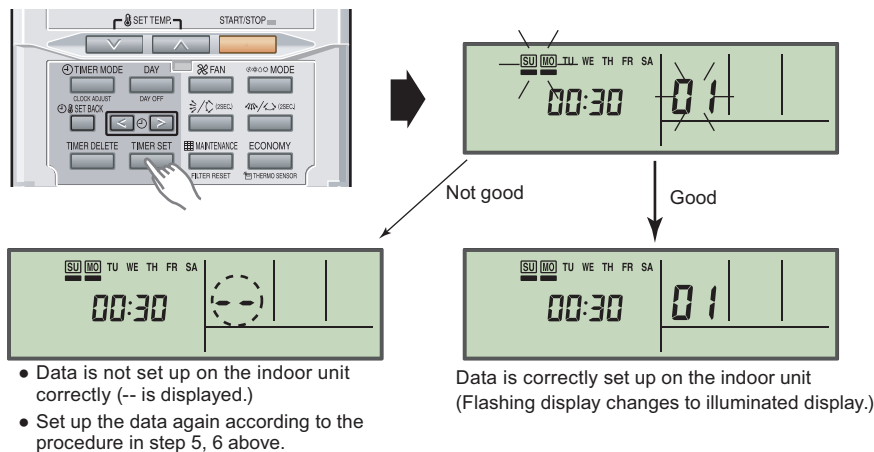

Function details: Refer to Chapter 12-4. ["Function details"](#) on page 67.

6. Exit the function setting mode by holding 3 buttons of SET TEMP.  $\nabla$ , SET TEMP.  $\wedge$  and FAN at the same time.

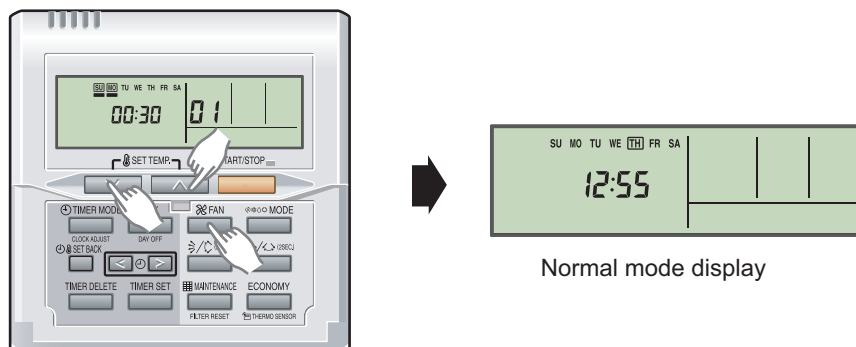

If no button is pressed within 60 seconds after buttons mentioned above are pressed, it will automatically exit the function setting mode.

If you exit the function setting mode unintentionally during setting, enter the mode again according to the procedure in step 2.

## ● Setting up each indoor unit

Repeat the procedures from step 1 to 6, and set up the indoor units requiring function setting.

## ● Resetting the power after setting up function of all indoor units

### NOTES:

- If the reset is not performed, function can not be read correctly.
- After all the functions have been set, the circuit breaker needs to be switched off for at least 2 minutes.
  - After the 2 minutes has passed, power can be restored.
  - The set function is stored in the PCB and will remain in memory even when the power of indoor unit is turned off.  
However setting function is effective after disconnecting the power supply and then reconnecting it.
- Record the latest configuration of the indoor unit function setting on a label, and put the label on the unit so it can be used for after-sales service operations.

## 12-3. Indoor unit (setting by simple remote controller)

- The function settings of the control of the indoor unit can be changed by this procedure according to the installation conditions. Incorrect settings can cause the indoor unit malfunction.
- After the power is turned on, perform the “Function setting” according to the installation conditions using the remote controller.
- The settings may be selected between the following two: Function number or Setting number.
- Settings will not be changed if invalid numbers or setting numbers are selected.
- This function cannot be used on the secondary units.

### ■ Preparation

Before connecting the power supply of the indoor unit, reconfirm following items:

- Piping air tight test and vacuuming have been performed firmly.
- There is no wiring mistake. Then, connect the power supply of the indoor unit.

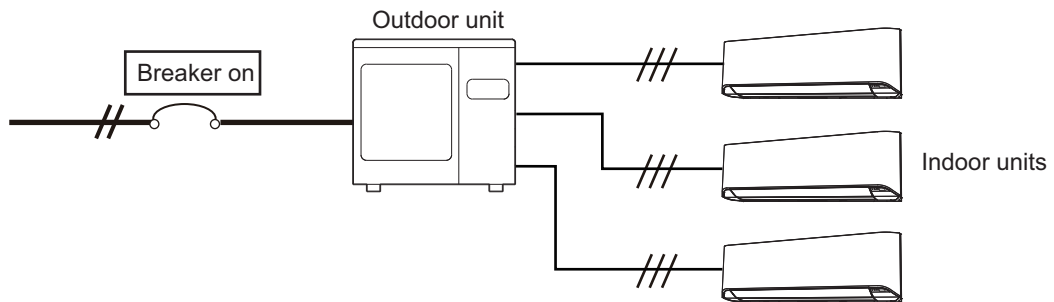

## ■ RXRSNUM

### ● Button name and function

During address setting mode, indoor unit reject the any operation command from remote controller.

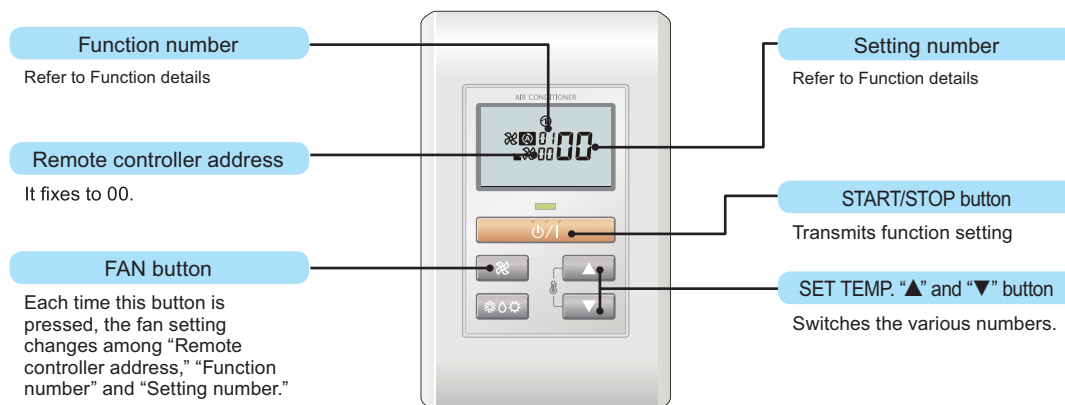

### ● Function setting procedure

1. Connect the power supply of the outdoor unit.
2. Switch to the function setting mode.  
To enter the function setting mode, hold down the 3 buttons of SET TEMP. ▲, SET TEMP. ▼ and FAN at the same time for 5 seconds or longer.

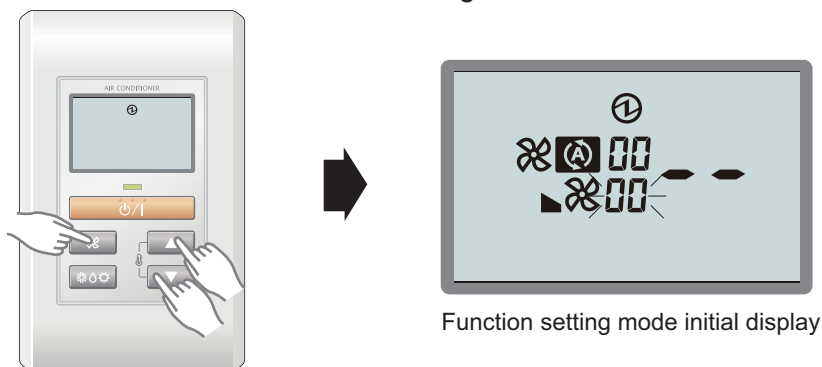

3. Press the FAN button.  
The Function number indicator flashes. Then, press either the SET TEMP. ▲ button or the SET TEMP. ▼ button to set up the function number.

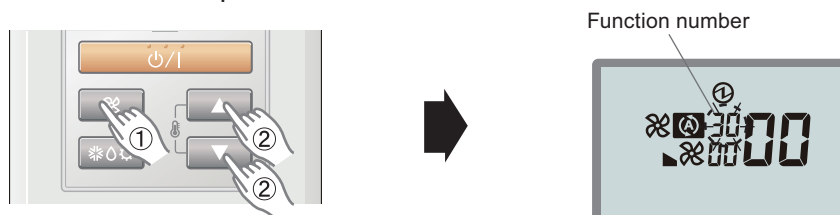

- Select the setting number by pressing the SET TEMP. ▲ or SET TEMP. ▼ button. The setting number indicator flashes during setting number selection.



Example) Function number : 30, Setting number : 01

- Confirm the setting by pressing the TIMER SET button. The data will be transferred to the indoor unit.

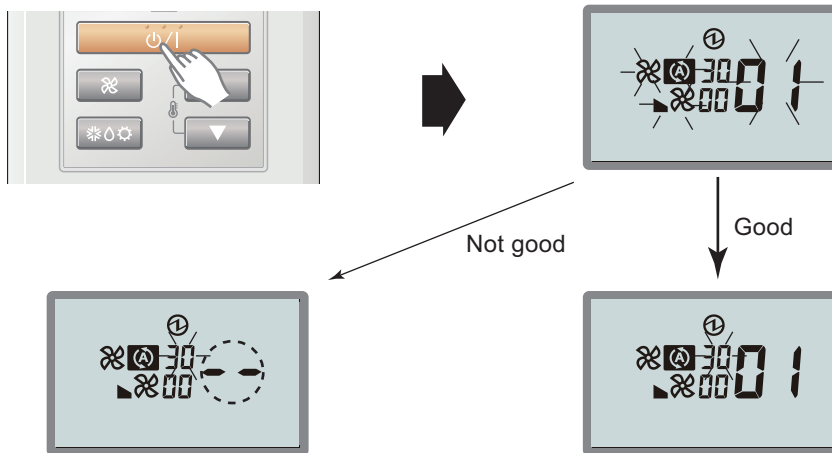

- Data is not set up on the indoor unit correctly (-- is displayed.)
- Set up the data again according to the procedure in step 3, 4 above.

Data is correctly set up on the indoor unit.

Function details: Refer to Chapter 12-4. ["Function details"](#) on page 67.

- Exit the function setting mode by pressing the 3 buttons of SET TEMP. ▲, SET TEMP. ▼, and FAN at the same time for 5 seconds or longer. After exiting the function setting mode, the display returns to the normal mode.

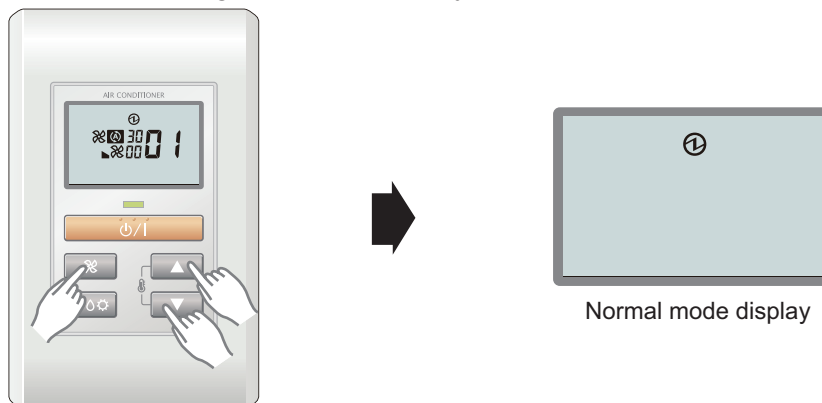

If no button is pressed within 60 seconds after buttons mentioned above are pressed, it will automatically exit the function setting mode.

If you exit the function setting mode unintentionally during setting, enter the mode again according to the procedure in step 2.

## ● Setting up each indoor unit

Repeat the procedures from step 1 to 6, and set up the indoor units requiring function setting.

## ● Resetting the power after setting up function of all indoor units

### NOTES:

- If the reset is not performed, function can not be read correctly.
- After all the functions have been set, the circuit breaker needs to be switched off for at least 2 minutes.
  - After the 2 minutes has passed, power can be restored.
  - The set function is stored in the PCB and will remain in memory even when the power of indoor unit is turned off.  
However setting function is effective after disconnecting the power supply and then reconnecting it.
- Record the latest configuration of the indoor unit function setting on a label, and put the label on the unit so it can be used for after-sales service operations.



## 12-4. Function details

### ■ Contents of function setting

Each function setting listed in this section is adjustable in accordance with the installation environment.

**NOTE:** Setting will not be changed if invalid numbers or setting values are selected.

### ● Function setting list

	Functions
1)	Filter sign
2)	Room temperature control for indoor unit sensor
3)	Auto restart
4)	Room temperature sensor switching
5)	Remote controller custom code
6)	External input control
7)	Room temperature sensor switching (Aux.)
8)	Indoor unit fan control for energy saving for cooling (for RIWH07/09/12/15AVFJ only)
9)	Room temperature control for wired remote controller sensor
10)	Heat insulation condition (building insulation)

#### 1) Filter sign

Select appropriate intervals for displaying the filter sign on the indoor unit according to the estimated amount of dust in the air of the room.

If the indication is not required, select "No indication" (03).

Function number	Setting value	Setting description	Factory setting
11	00	Standard (400 hours)	
	01	Long interval (1,000 hours)	
	02	Short interval (200 hours)	
	03	No indication	◆

## 2) Room temperature control for indoor unit sensor

**NOTE:** Before performing this setting, refer to Function 95.

Depending on the installed environment, correction of the room temperature sensor may be required. Select the appropriate control setting according to the installed environment.

The temperature correction values show the difference from the Standard setting "00" (manufacturer's recommended value).

\*When Function 95-01 (High insulation) is set, the Standard setting "00" will be the same as "No correction 0.0 °F (0.0 °C)" (01).

Function number		Setting value	Setting description	Factory setting	
30 (For cooling)	31 (For heating)	00	Standard setting*	◆	
		01	No correction 0.0 °F (0.0 °C)		
		02	-1 °F (-0.5 °C)	More cooling Less heating	
		03	-2 °F (-1.0 °C)		
		04	-3 °F (-1.5 °C)		
		05	-4 °F (-2.0 °C)		
		06	-5 °F (-2.5 °C)		
		07	-6 °F (-3.0 °C)		
		08	-7 °F (-3.5 °C)		
		09	-8 °F (-4.0 °C)		
		10	+1 °F (+0.5 °C)	Less cooling More heating	
		11	+2 °F (+1.0 °C)		
		12	+3 °F (+1.5 °C)		
		13	+4 °F (+2.0 °C)		
		14	+5 °F (+2.5 °C)		
		15	+6 °F (+3.0 °C)		
		16	+7 °F (+3.5 °C)		
17	+8 °F (+4.0 °C)				

## 3) Auto restart

Enables or disables automatic restart after a power interruption.

Function number	Setting value	Setting description	Factory setting
40	00	Enable	◆
	01	Disable	

**NOTE:** Auto restart is an emergency function such as for power outage etc. Do not attempt to use this function in normal operation. Be sure to operate the unit by remote controller or external device.

## 4) Room temperature sensor switching

(Only for wired remote controller)

When using the wired remote controller temperature sensor, change the setting to "Both" (01).

Function number	Setting value	Setting description	Factory setting
42	00	Indoor unit	◆
	01	Both	

00: Sensor on the indoor unit is active.

01: Sensors on both indoor unit and wired remote controller are active.

**NOTE:** Remote controller sensor must be turned on by using the remote controller.

**5) Remote controller custom code**

(Only for wireless remote controller)

The indoor unit custom code can be changed. Select the appropriate custom code.

Function number	Setting value	Setting description	Factory setting
44	00	A	◆
	01	B	
	02	C	
	03	D	

**6) External input control**

"Operation/Stop" mode or "Forced stop" mode can be selected.

Function number	Setting value	Setting description	Factory setting
46	00	Operation/Stop mode	◆
	01	(Setting prohibited)	
	02	Forced stop mode	

**7) Room temperature sensor switching (Aux.)**

To use the temperature sensor on the wired remote controller only, change the setting to "Wired remote controller" (01).

This function will only work if the function setting 42 is set at "Both" (01).

When the setting value is set to "Both" (00), more suitable control of the room temperature is possible by setting function setting 30 and 31 too.

Function number	Setting value	Setting description	Factory setting
48	00	Both	◆
	01	Wired remote controller	

**8) Indoor unit fan control for energy saving for cooling (for RIWH07/09/12/15AVFJ only)**

Enables or disables the power-saving function by controlling the indoor unit fan rotation when the outdoor unit is stopped during cooling operation.

Function number	Setting value	Setting description	Factory setting
49	00	Disable	◆
	01	Enable	

00: When the outdoor unit is stopped, the indoor unit fan operates continuously following the setting on the remote controller.

01: When the outdoor unit is stopped, the indoor unit fan operates intermittently at a very low speed.

## 9) Room temperature control for wired remote controller sensor

**NOTE:** Before performing this setting, refer to Function 95.

Depending on the installed environment, correction of the room temperature sensor may be required. Select the appropriate control setting according to the installed environment.

To change this setting, set Function 42 to "Both" (01).

Ensure that the thermo sensor icon is displayed on the remote controller screen.

Function number		Setting value	Setting description	Factory setting	
92 (For cooling)	93 (For heating)	00	No correction 0.0 °F (0.0 °C)	◆	
		01	No correction 0.0 °F (0.0 °C)		
		02	-1 °F (-0.5 °C)	More cooling Less heating	
		03	-2 °F (-1.0 °C)		
		04	-3 °F (-1.5 °C)		
		05	-4 °F (-2.0 °C)		
		06	-5 °F (-2.5 °C)		
		07	-6 °F (-3.0 °C)		
		08	-7 °F (-3.5 °C)		
		09	-8 °F (-4.0 °C)		
		10	+1 °F (+0.5 °C)	Less cooling More heating	
		11	+2 °F (+1.0 °C)		
		12	+3 °F (+1.5 °C)		
		13	+4 °F (+2.0 °C)		
		14	+5 °F (+2.5 °C)		
		15	+6 °F (+3.0 °C)		
		16	+7 °F (+3.5 °C)		
17	+8 °F (+4.0 °C)				

## 10) Heat insulation condition (building insulation)

Heat insulation conditions differ according to the installed environment.

"Standard insulation" (00) allows system to rapidly respond to the cooling or heating load changes.

"High insulation" (01) is when the heat insulation structure of the building is high and does not require system to rapidly respond to cooling or heating load changes.

When "High insulation" (01) is selected:

- Overheating (overcooling) is prevented at the start-up.
- All room-temperature control settings (Function 30, 31, 92, and 93) will reset to "No correction 0.0 °F (0.0 °C)".

Function number	Setting value	Setting description	Factory setting
95	00	Standard insulation	◆
	01	High insulation	

**NOTE:** When changing Function 95, perform this setting before other room-temperature control settings (Function 30, 31, 92, and 93). If Function 95 is not set first, room-temperature control settings (Function 30, 31, 92, and 93) will be reset and you must re-do them again.

## 12-5. Wired remote controller

DIP switch 1	SW1	Prohibited
	SW2	Dual remote controller setting
	SW3	Prohibited
	SW4	°F/°C switch
	SW5	Prohibited
	SW6	Memory backup setting

\* Do not use DIP switch 2.

### Switch location

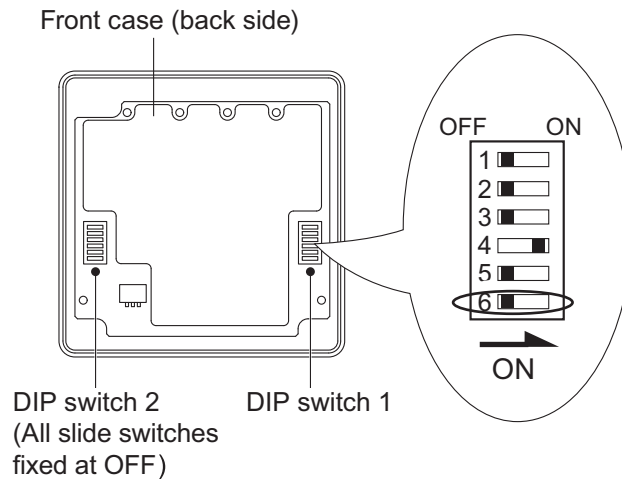

### Dip switch 1 setting

#### SW2: Dual remote controller setting

Set the remote controller SW2 according to the following table.

Number of remote controller	Primary unit	Secondary unit	Factory setting
	SW2	SW2	
1 (Normal)	OFF	—	◆
2 (Dual)	OFF	ON	

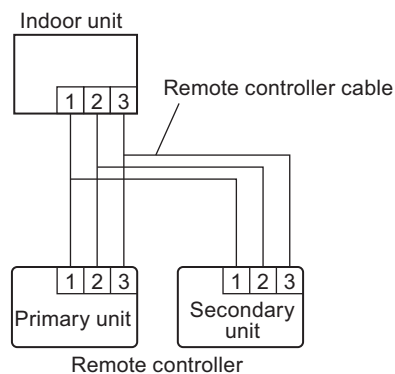

#### SW4: Switching temperature unit °F / °C

Displayed temperature unit can be switched between Fahrenheit (°F) and Celsius (°C).

SW4	Fahrenheit (°F) / Celsius (°C)	Factory setting
OFF	°C	
ON	°F	◆

## ● SW6: Memory backup setting (only for wired remote controller)

Set to "ON" to use batteries for the memory backup.

When batteries are not used, all of settings stored in memory will be deleted if there is a power failure.

SW6	Memory backup	Factory setting
OFF	Invalidity	◆
ON	Validity	

**NOTE:** Never turn it on in the case of simple remote controller.

## 12-6. Simple remote controller

DIP switch	SW1	Prohibited
	SW2	Dual remote controller setting
	SW3	°F/°C switch
	SW4	Prohibited
	SW5	Prohibited
	SW6	Prohibited

### ■ Switch location

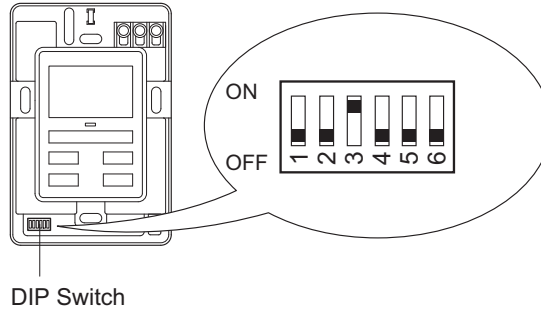

### ■ Dip switch setting

#### ● SW2: Dual remote controller setting

Set the remote controller SW2 according to the following table.

Number of remote controller	Primary unit	Secondary unit	Factory setting
	SW2	SW2	
1 (Normal)	OFF	—	◆
2 (Dual)	OFF	ON	

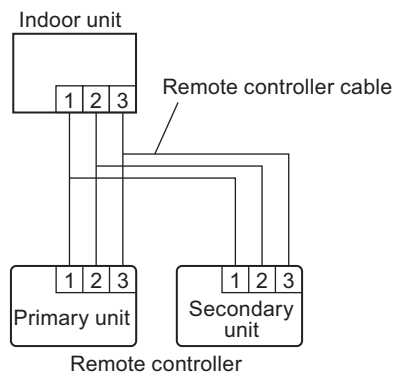

#### ● SW3: Switching temperature unit °F / °C









Displayed temperature unit can be switched between Fahrenheit (°F) and Celsius (°C).

SW3	Fahrenheit (°F) / Celsius (°C)	Factory setting
OFF	°C	
ON	°F	◆

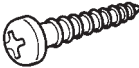
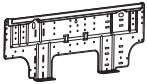
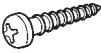
## 13. Accessories

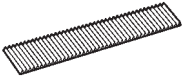

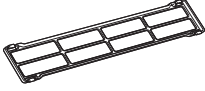
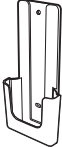







### 13-1. Wall mounted type

#### ■ Models: RIWH07AVFJ, RIWH09AVFJ, RIWH12AVFJ, and RIWH15AVFJ

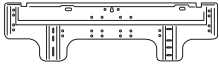
Part name	Exterior	Q'ty	Part name	Exterior	Q'ty
Operating manual		1	Cloth tape		1
Installation manual		1	Tapping screw (large), M4 × 25 mm		5
Wall hook bracket		1	Tapping screw (small),		2
Remote controller		1	Air cleaning filter		2
Battery		2	Filter holder		2
Remote controller holder		1	Seal A <ul style="list-style-type: none"> <li>• It is necessary when using 15 model.</li> <li>• It is used when the diameter of gas pipe is <math>\varnothing 12.70</math> or more.</li> </ul>		1

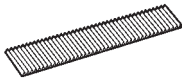

## ■ Models: RIWH18AVFJ and RIWH24AVFJ

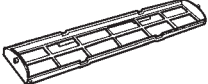
Part name	Exterior	Q'ty	Part name	Exterior	Q'ty
Operating manual		1	Drain hose insulation		1
Installation manual		1	Cloth tape		1
Wall hook bracket		1	Tapping screw (large), M4 × 25 mm		8
Remote controller		1	Tapping screw (small)		2
Battery		2	Air cleaning filter		2
Remote controller holder		1	Air cleaning filter frame		2

# 14. Optional parts

## 14-1. Controllers



### Lineup

Indoor unit type		Type			
		Wired remote controller	Wireless remote controller		Simple remote controller
		RXRNNUM	AR-RAH2U	AR-REG1U	RXRSNUM
Wall mounted	RIWH07AVFJ	○*	—	●	○*
	RIWH09AVFJ				
	RIWH12AVFJ				
	RIWH15AVFJ	○	●	—	○
	RIWH18AVFJ				
RIWH24AVFJ					

●: Accessory, ○: Optional, —: Not applicable

\*: Optional Communication kit (RXXCBXZ2) is necessary for the installation.

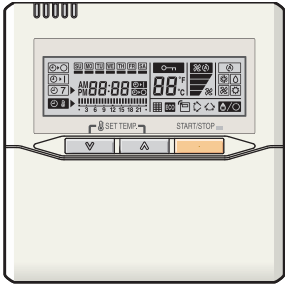
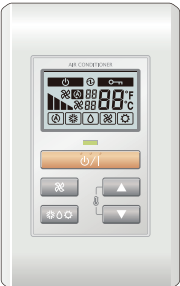
### Parts

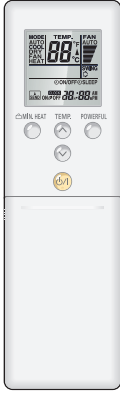
Wired remote controller	Simple remote controller
 <p>RXRNNUM</p>	 <p>RXRSNUM</p>
Wireless remote controller	
 <p>AR-RAH2U</p>	 <p>AR-REG1U</p>

## 14-2. Others



### Lineup

Indoor unit type		Type		
		External connect kit		Communication kit
		RXXWZX	RXXWZXZ5	RXXCBXZ2
Wall mounted	RIWH07AVFJ RIWH09AVFJ RIWH12AVFJ RIWH15AVFJ	—	○*1	○
	RIWH18AVFJ RIWH24AVFJ	○	—	—

●: Accessory, ○: Optional, —: Not applicable

\*1: Optional Communication kit (RXXCBXZ2) is necessary for the installation.

### Parts

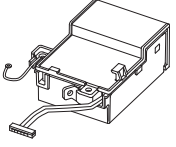
External connect kit Model: RXXWZX	External connect kit Model: RXXWZXZ5
 <p>(x1) (x1)</p> <p>For wall mounted type (RIWH18AVFJ and RIWH24AVFJ)</p>	 <p>(x1) (x2)</p> <p>For wall mounted type (RIWH07AVFJ, RIWH09AVFJ, RIWH12AVFJ, and RIWH15AVFJ)</p>
Communication kit Model: RXXCBXZ2	
 <p>For wall mounted type (RIWH07AVFJ, RIWH09AVFJ, RIWH12AVFJ, and RIWH15AVFJ)</p>	

---

## 15. Indoor unit installation precautions

**NOTE:** The information listed below are general precautions.  
Some models also include items that do not apply.

---

### 15-1. Place where prohibited for use

- Places where there is a danger of combustible gas leakage.
- Places where sulfur gas, chlorine gas, acid, alkali, or other matter which effects equipment is generated.
- Places where there is a lot of oil splash and steam such as kitchen or machinery room.
- Places where machinery which generates high frequencies is used.
- Ocean beaches and other areas where there is a lot of salt.
- Places where carbon fibers or any kind of powder suspended in the air.
- Inside of vehicles, ships, and other conveyances.
- Places where voltage fluctuations are large such as a factory.

## 15-2. Points to remember when installing

- The product shall be installed at a place which can withstand the weight and vibration of the indoor.
- To allow maintenance after refrigerant piping, drain piping, and electric wiring connection and installation, provide an installation service space and an inspection port, as required.  
\*Installation service space is shown on "Dimensions" on page 8.
- Be careful when installing the unit at the following places.

Condition	Contents	Countermeasures (Reference)
When the ceiling is high.	If the indoor unit is installed where the installation height given in the installation manual is exceeded, the temperature difference between the floor and ceiling of the room will be large and the heating effect will be poor. Moreover, even if the indoor unit is installed within the installation height, a similar phenomena will occur when installed in a room in which the doors are opened and closed frequently and hot air circulation is obstructed by furniture such as desks or chairs.	<ol style="list-style-type: none"> <li>1. Switch the setting to the high ceiling mode.</li> <li>2. Install a circulator.</li> <li>3. Arrange the furniture in the room so that it does not obstruct the hot air.</li> </ol>
When lower level directly contacts the outside air.	When the lower level of the room is a semi-open space such as warehouse or parking lot the surface temperature of the flooring will become low and the radiation of cold from the floor will increase. In this case, even if the room temperature is suitable, you may feel the foot level is cold.	
When the air flow distribution is poor.	When an indoor unit is installed in a position where the outlet airflow will directly contact people, a draft may be felt. In addition, when there are obstructions in the path of the intake and outlet airflow, the air distribution may become extremely bad.	<ol style="list-style-type: none"> <li>1. Adjust the louver fins or take other measures matched to the site.</li> <li>2. Change the indoor unit outlet.</li> </ol>
When inside the ceiling is high temperature and high humidity.	When the indoor unit is installed where the inside of the ceiling is 30 °C (86 °F) RH80% or greater, the dew point temperature of the outer perimeter may become higher than the cabinet surface temperature and moisture will condense on the surface of the cabinet and water drops may fall inside the room. →Refer to Fig. A. In addition, the humidity may vary considerably the same as when the inside of the ceiling is close to hermetically sealed and used as the outside air intake path.	<ol style="list-style-type: none"> <li>1. Add heat insulating material to the outside of the indoor unit cabinet. *Regarding the cassette type, use of optional High humidity correspondence kit is recommended.</li> <li>2. Strengthen the heat insulating material of the refrigerant piping and drain piping too. →Refer to Fig. B.</li> <li>3. When the humidity inside the ceiling changes considerably, install a ventilation port.</li> </ol>

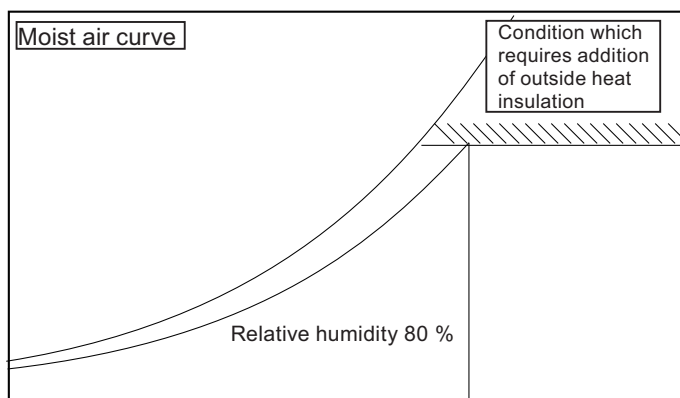

Dry bulb temperature 30 °C (86 °F)

Fig. A

**Work method when reinforcing the heat insulation of on-site piping**

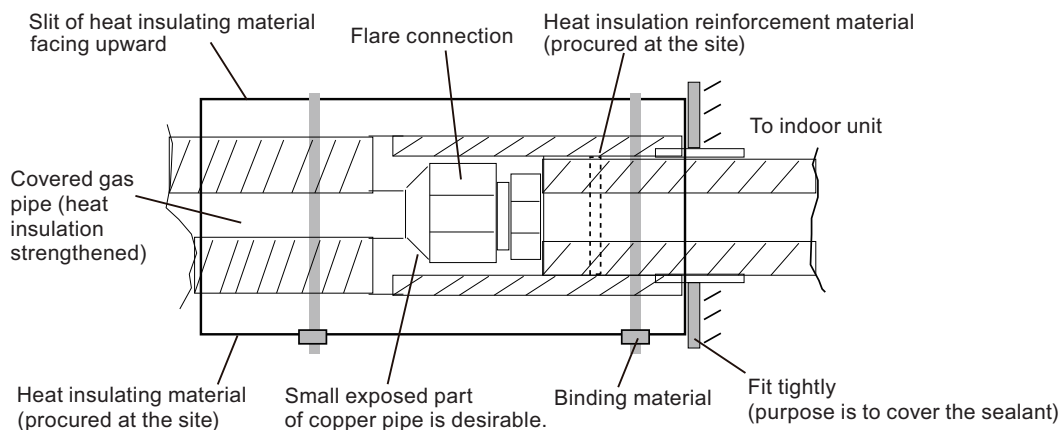

Fig. B

Condition	Contents	Countermeasures (Reference)
When the remote controller installation site is bad.	If the cold or warm air blown out from the air conditioner directly contacts the thermostat section of the remote controller, the outlet temperature of the air conditioner may be sensed and room temperature control will be different from the room temperature, and “not cooled” or “not heated” or other trouble may occur. In addition, there is the possibility that the same kind of trouble may also occur when the remote controller is effected by direct sunlight.	<ol style="list-style-type: none"> <li>1. Install the remote controller where it will not be directly exposed to the cold or hot air.</li> <li>2. Install the remote controller where it will not be directly exposed to sunlight or strong lighting.</li> </ol>
When installation environment is quiet.	When the wall mounted type was installed in a bedroom, living room, or other quiet place, the sound of the refrigerant flow may be sensed as noise and must be taken into account.	<ol style="list-style-type: none"> <li>1. Plan installation of a model with external expansion valve.</li> <li>2. Plan installation of a branch box farther from indoor unit.</li> <li>3. Plan installation using another air conditioner.</li> </ol>
When using the wireless remote controller.	Signals may not be received when using it in a room illuminated by an inverter fluorescent lamp.	Turn on the fluorescent lamp and check if the indoor unit receives the signals from the remote controller. If the indoor unit does not receive the signals, consult an authorized service personnel.
When installing the inverter type.	It may generate noise in TV sets, stereos and PCs.	The inverter type should be installed at a sufficient distance from these equipments.

# **Part 2. OUTDOOR UNIT**

---

**5 ROOMS TYPE:  
ROMH45AFXZJ**

# 1. Specifications

## 1-1. Model: ROMH45AFXZJ

OUTDOOR UNIT  
ROMH45AFXZJ

Type				Inverter heat pump	
Model name				ROMH45AFXZJ	
Power source				1Ø 208/230 V 60 Hz	
Available voltage range				187—264V	
Connectable indoor unit			Number	2 to 5	
			Total capacity range	34,000 to 54,000 Btu/h	
Combination of indoor unit				RIWH09AVFJ x 5	
Capacity	Cooling	Rated	Btu/h	45,000	
			kW	13.2	
		Min. - Max.	Btu/h	12,000—48,000	
	Heating	Rated	kW	3.5—14.0	
			Btu/h	48,000	
		Min. - Max.	Btu/h	12,000—54,000	
				kW	3.5—15.8
Input power	Cooling	Rated	kW	4.28	
		Max.		4.77	
	Heating	Rated		3.88	
		Max.		4.32	
Current	Cooling	Rated	A	18.7	
	Heating	Rated	Btu/W	17.0	
EER	Cooling	Rated	Btu/W	10.5	
SEER *1	Cooling		-	19.7	
COP	Heating	Rated	W/W	3.60	
HSPF *1	Heating		-	10.3	
Starting current			A	20.1	
Maximum operating current *2			A	23.8	
Fan	Type x Q'ty			Propeller x 1	
	Airflow rate	Cooling	CFM (m <sup>3</sup> /h)	2,472 (4,200)	
		Heating		2,472 (4,200)	
	Motor	Type x Quantity		DC motor x 1	
Output		W	111		
Sound pressure level	Cooling	Rated	dB (A)	53	
	Heating			55	
Heat exchanger	Dimension (H x W x D)		in (mm)	38-1/16 x 36-5/16 x 2-3/16 (966 x 922 x 55)	
	Fin pitch		FPI	1.45	
	Rows x Stages			2 x 38	
	Pipe type (Material)			Grooved H-pin (Copper)	
	Fin	Type (Material)		Corrugate (Aluminum)	
		Surface treatment		Corrosion resistance (Blue Fin)	
Compressor	Type x Quantity		DC twin rotary x 1		
	Motor output		W	2,100	
Refrigerant	Type			R410A	
	Charge	lb (g)	8 lb 13 oz (4,000)		
Refrigerant oil	Type			RB68	
	Amount	in <sup>3</sup> (cm <sup>3</sup> )	70.1(1,150)		
Enclosure	Material		Painted galvanized steel		
	Color		Beige (Approximate color of MUNSELL 10YR 7.5/1.0NN)		
Dimensions	Net	(H x W x D)	in (mm)	39-5/16 x 38-3/16 x 14-9/16 (998 x 970 x 370)	
	Gross			45-3/4 x 45-1/4 x 18-13/16 (1,162 x 1,150 x 478)	
Weight	Net			205 (93)	
	Gross			229 (104)	
Connection pipe	Size	Liquid	in (mm)	Ø1/4 (Ø6.35) x 5	
		Gas		Ø3/8 (Ø9.52) x 3 + Ø1/2 (Ø12.70) x 2	
	Method		Flare		
	Pre-charge length (Total)		164 (50)		
	Max. length (Total)		262 (80)		
	Max. length (Each)		82 (25)		
	Min. length (Total)		49 (15)		
	Min. length (Each)		16 (5)		
	Max. height difference between outdoor unit and each indoor Units.		49 (15)		
	Max. height difference between indoor units.		33 (10)		
Operation range	Cooling			14 to 115 (-10 to 46)	
	Heating			5 to 75 (-15 to 24)	

**NOTES:**

- Specifications are based on the following conditions:
  - Power source of specifications : 230 V
  - Pipe length : 24.6 ft (7.5 m), Height difference : 0 ft (0 m) [Outdoor unit - Indoor unit]
  - Cooling: Indoor temperature of 80 °FDB (26.7 °CDB) / 67 °FWB (19.4 °CWB), and outdoor temperature of 95 °FDB (35 °CDB) / 75 °FWB (23.9 °CWB).
  - Heating: Indoor temperature of 70 °FDB (21.1 °CDB) / 60 °FWB (15.6 °CWB), and outdoor temperature of 47 °FDB (8.3 °CDB) / 43 °FWB (6.1 °CWB).
  - \*1: Test conditions are based on AHRI 210 / 240.
  - \*2: The maximum current is the maximum value when the operated within the operation range.
- For other combination, refer to the combination table.
- The protective function might work when using it outside the operation range.





# 3. Installation space

## 3-1. Model: ROMH45AFXZJ

### ■ Space requirement

Provide sufficient installation space for product safety.

#### ● Single outdoor unit installation

- When the upper space is open:

Unit: in (mm)

When there are obstacles at the rear only.

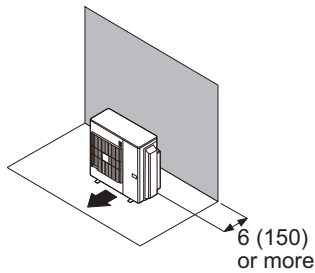

When there are obstacles at the rear and sides.

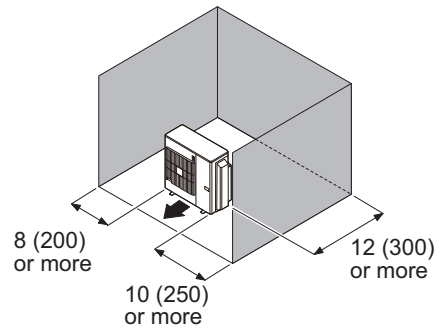

When there are obstacles at the front only.

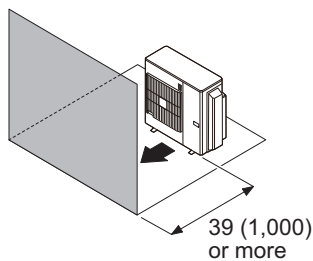

When there are obstacles at the front and rear.

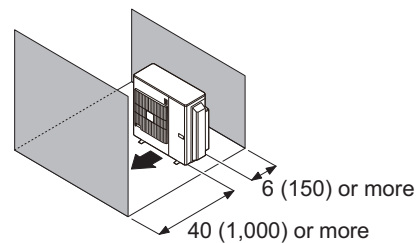

- When there is an obstruction in the upper space:

Unit: in (mm)

When there are obstacles at the rear and above.

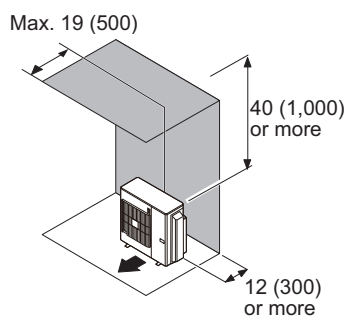

When there are obstacles at the rear, sides, and above.

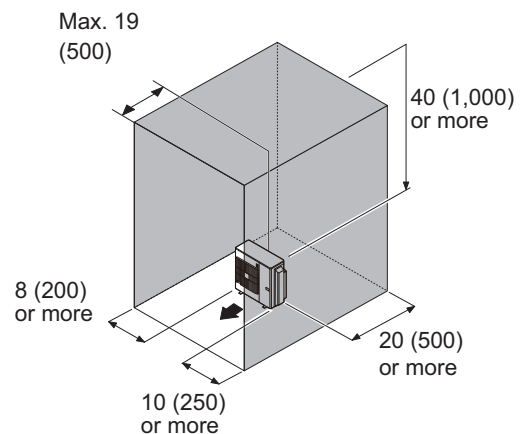

## ● Multiple outdoor unit installation

- When the upper space is open:

Unit: in (mm)

When there are obstacles at the rear only.

When there are obstacles at the front only.

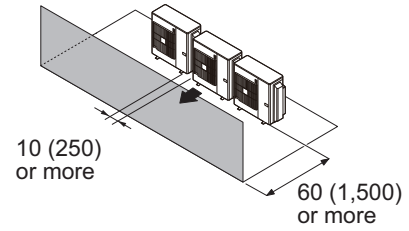
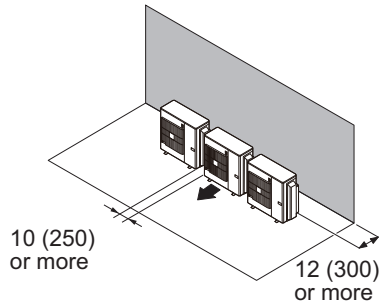

When there are obstacles at the front and rear.

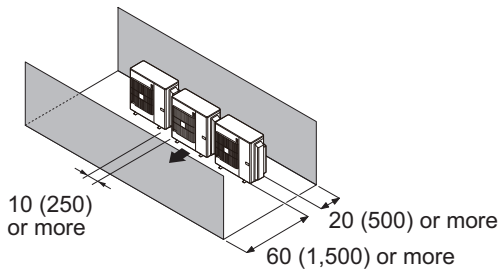

- When there is an obstruction in the upper space:

Unit: in (mm)

When there are obstacles at the rear and above.

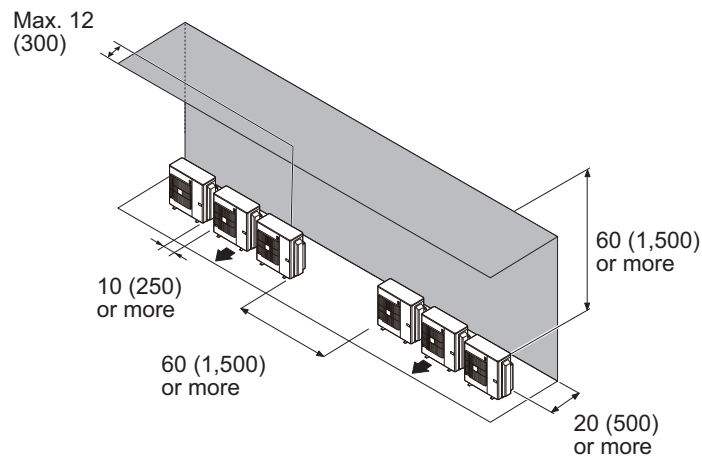

OUTDOOR UNIT  
ROMH45AFXJ

## ● Outdoor unit installation in multi-row

Unit: in (mm)

Single parallel unit arrangement

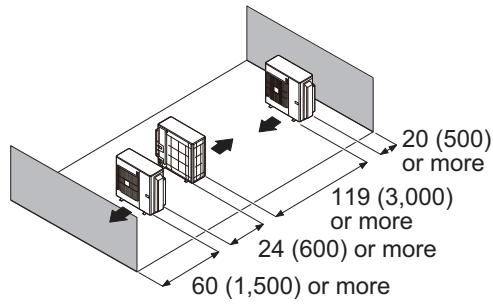

Multiple parallel unit arrangement

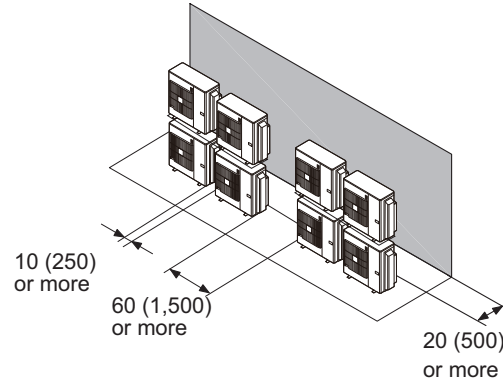
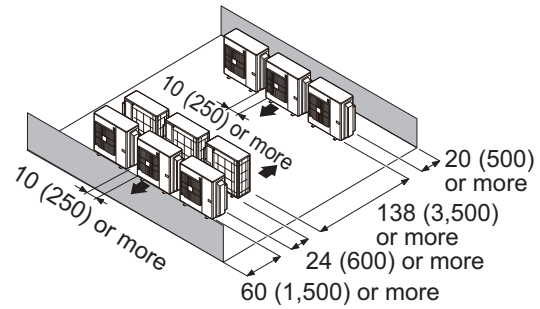

### NOTES:

- If the space is larger than stated above, the condition will be the same as when there is no obstacle.
- Height above the floor level should be 2 in (50 mm) or more.
- When installing the outdoor unit, be sure to open the front and left side to obtain better operation efficiency.

### ⚠ CAUTION

- Do not install the outdoor unit in two-stage where the drain water could freeze. Otherwise the drainage from the upper unit may form ice and cause a malfunction of the lower unit.
- When the outdoor temperature is 32 °F (0 °C) or less, do not use the accessory drain pipe and drain cap. If the drain pipe and drain cap are used, the drain water in the pipe may freeze in extremely cold climate. (For reverse cycle model only.)
- In area with heavy snowfall, if the inlet and outlet of the outdoor unit is blocked with snow, it might become difficult to get warm, and it is likely to cause product malfunction. Construct a canopy and a pedestal, or place the unit on a high stand that is locally installed.

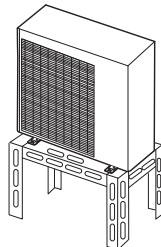

# 4. Refrigerant circuit

## 4-1. Model: ROMH45AFXZJ

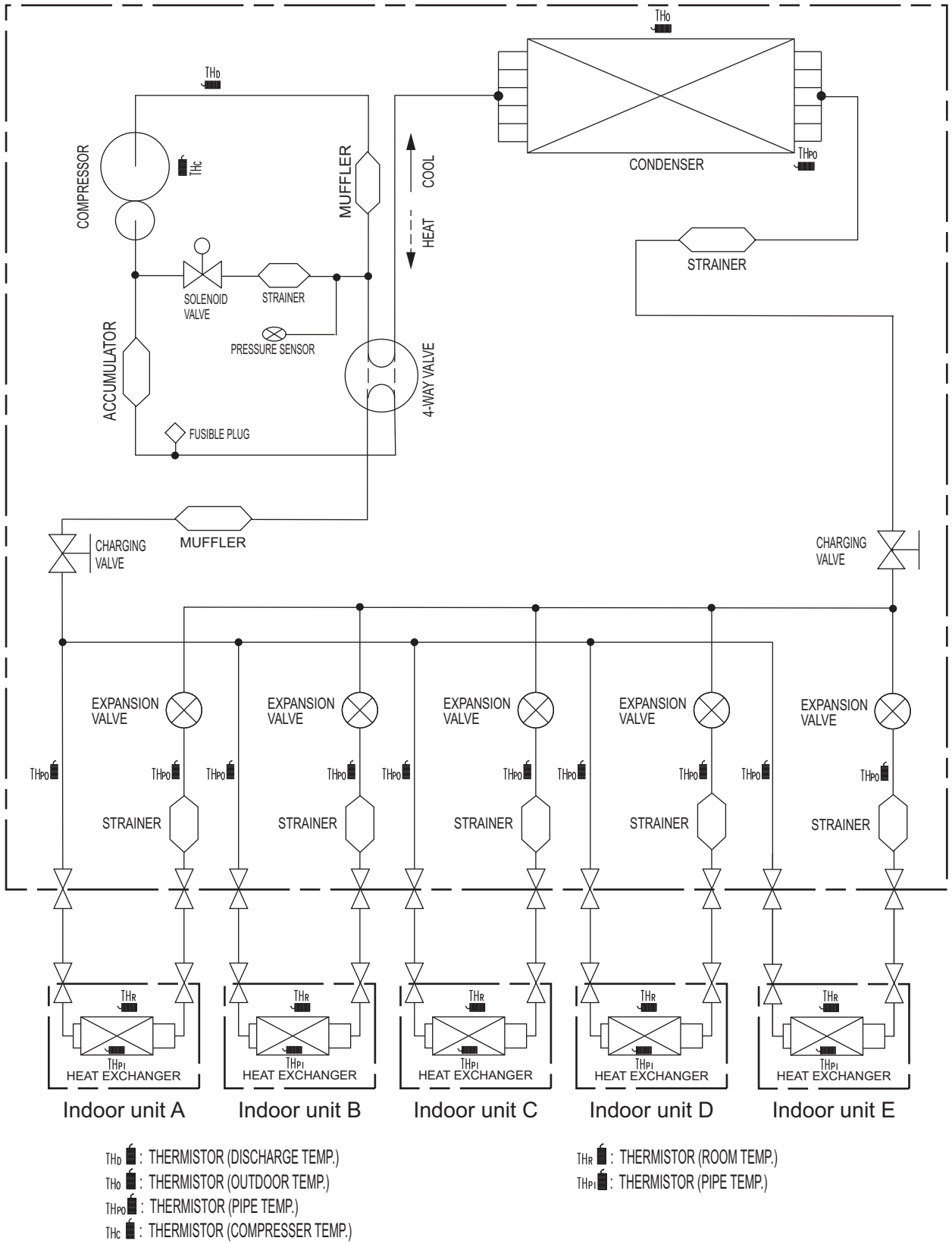

OUTDOOR UNIT  
ROMH45AFXZJ

# 5. Wiring diagram

## 5-1. Model: ROMH45AFXZJ

OUTDOOR UNIT  
ROMH45AFXZJ

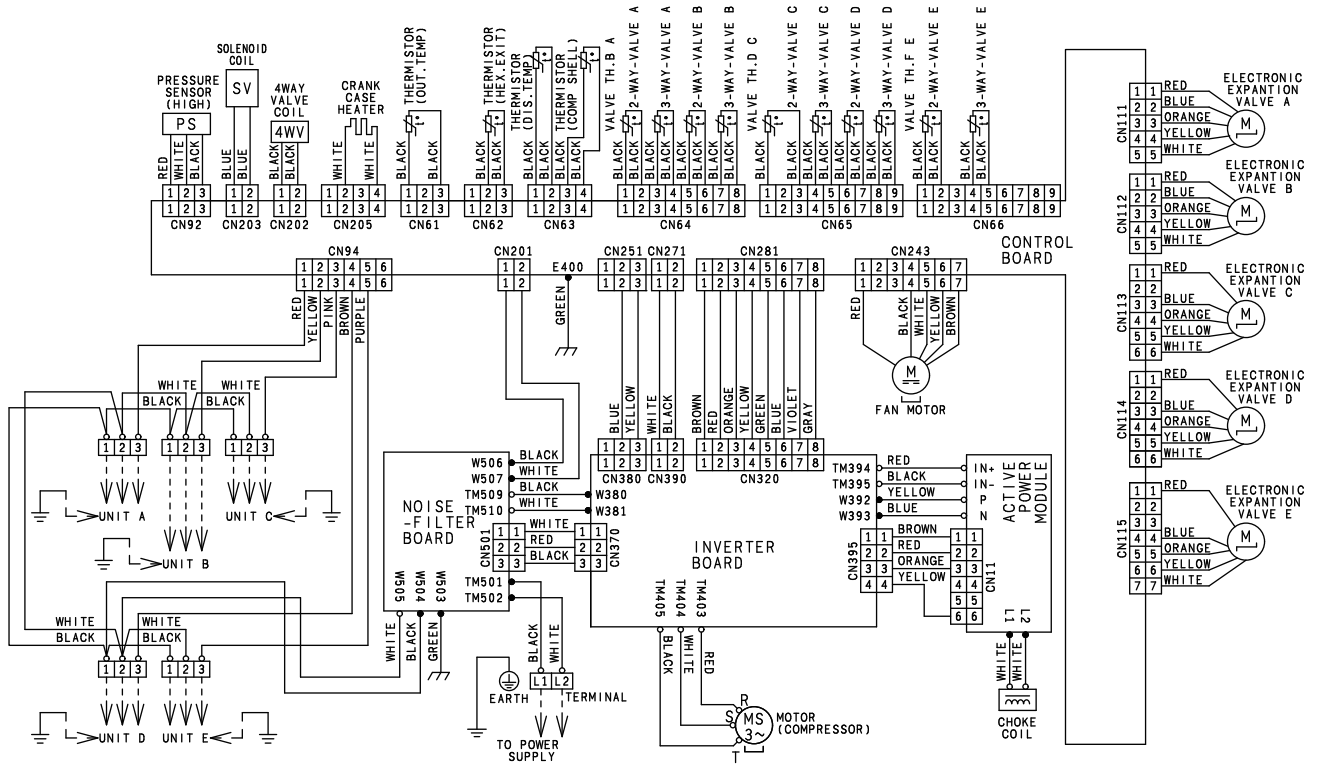

# 6. Capacity table

## 6-1. Combinations

### ■ Model: ROMH45AFXZJ

#### ● Cooling

Combination of indoor unit						Type of indoor unit	Rated capacity for each indoor unit [kBTu/h]					Maximum capacity for each indoor unit [kBTu/h]					Total capacity [kBTu/h]			Input power [kW]		
Room 1	Room 2	Room 3	Room 4	Room 5	Total		Room 1	Room 2	Room 3	Room 4	Room 5	Room 1	Room 2	Room 3	Room 4	Room 5	Min.	Rated	Max.	Min.	Rated	Max.
18	18	—	—	—	36	Non-ducted	18.0	18.0	—	—	19.2	19.2	—	—	—	12.0	36.0	38.4	0.80	3.28	3.42	
12	24	—	—	—	36	Non-ducted	12.0	24.0	—	—	12.8	25.6	—	—	—	12.0	36.0	38.4	0.80	3.28	3.42	
15	24	—	—	—	39	Non-ducted	15.0	24.0	—	—	16.0	25.6	—	—	—	12.0	39.0	41.6	0.80	3.72	3.89	
18	24	—	—	—	42	Non-ducted	18.0	24.0	—	—	19.2	25.6	—	—	—	12.0	42.0	44.8	0.80	4.17	4.36	
24	24	—	—	—	48	Non-ducted	22.5	22.5	—	—	24.0	24.0	—	—	—	12.0	45.0	48.0	0.80	4.55	4.77	
7	7	24	—	—	38	Non-ducted	7.0	7.0	24.0	—	—	7.5	7.5	25.6	—	12.0	38.0	40.5	0.80	3.50	3.73	
7	9	18	—	—	34	Non-ducted	7.0	9.0	18.0	—	—	7.5	9.6	19.2	—	12.0	34.0	36.3	0.80	2.92	3.10	
7	9	24	—	—	40	Non-ducted	7.0	9.0	24.0	—	—	7.5	9.6	25.6	—	12.0	40.0	42.7	0.80	3.79	4.05	
7	12	18	—	—	37	Non-ducted	7.0	12.0	18.0	—	—	7.5	12.8	19.2	—	12.0	37.0	39.5	0.80	3.35	3.58	
7	12	24	—	—	43	Non-ducted	7.0	12.0	24.0	—	—	7.5	12.8	25.6	—	12.0	43.0	45.9	0.80	4.22	4.52	
7	15	15	—	—	37	Non-ducted	7.0	15.0	15.0	—	—	7.5	16.0	16.0	—	12.0	37.0	39.5	0.80	3.35	3.58	
7	15	18	—	—	40	Non-ducted	7.0	15.0	18.0	—	—	7.5	16.0	19.2	—	12.0	40.0	42.7	0.80	3.79	4.05	
7	15	24	—	—	46	Non-ducted	6.8	14.7	23.5	—	—	7.3	15.7	25.0	—	12.0	45.0	48.0	0.80	4.46	4.77	
7	18	18	—	—	43	Non-ducted	7.0	18.0	18.0	—	—	7.5	19.2	19.2	—	12.0	43.0	45.9	0.80	4.22	4.52	
7	18	24	—	—	49	Non-ducted	6.4	16.5	22.0	—	—	6.9	17.6	23.5	—	12.0	45.0	48.0	0.80	4.46	4.77	
9	9	18	—	—	36	Non-ducted	9.0	9.0	18.0	—	—	9.6	9.6	19.2	—	12.0	36.0	38.4	0.80	3.21	3.42	
9	9	24	—	—	42	Non-ducted	9.0	9.0	24.0	—	—	9.6	9.6	25.6	—	12.0	42.0	44.8	0.80	4.08	4.36	
9	12	15	—	—	36	Non-ducted	9.0	12.0	15.0	—	—	9.6	12.8	16.0	—	12.0	36.0	38.4	0.80	3.21	3.42	
9	12	18	—	—	39	Non-ducted	9.0	12.0	18.0	—	—	9.6	12.8	19.2	—	12.0	39.0	41.6	0.80	3.64	3.89	
9	12	24	—	—	45	Non-ducted	9.0	12.0	24.0	—	—	9.6	12.8	25.6	—	12.0	45.0	48.0	0.80	4.46	4.77	
9	15	15	—	—	39	Non-ducted	9.0	15.0	15.0	—	—	9.6	16.0	16.0	—	12.0	39.0	41.6	0.80	3.64	3.89	
9	15	18	—	—	42	Non-ducted	9.0	15.0	18.0	—	—	9.6	16.0	19.2	—	12.0	42.0	44.8	0.80	3.92	4.36	
9	15	24	—	—	48	Non-ducted	8.4	14.1	22.5	—	—	9.0	15.0	24.0	—	12.0	45.0	48.0	0.80	4.28	4.77	
9	18	18	—	—	45	Non-ducted	9.0	18.0	18.0	—	—	9.6	19.2	19.2	—	12.0	45.0	48.0	0.80	4.28	4.77	
9	18	24	—	—	51	Non-ducted	7.9	15.9	21.2	—	—	8.5	16.9	22.6	—	12.0	45.0	48.0	0.80	4.28	4.77	
12	12	12	—	—	36	Non-ducted	12.0	12.0	12.0	—	—	12.8	12.8	12.8	—	12.0	36.0	38.4	0.80	3.08	3.42	
12	12	15	—	—	39	Non-ducted	12.0	12.0	15.0	—	—	12.8	12.8	16.0	—	12.0	39.0	41.6	0.80	3.50	3.89	
12	12	18	—	—	42	Non-ducted	12.0	12.0	18.0	—	—	12.8	12.8	19.2	—	12.0	42.0	44.8	0.80	3.22	4.36	
12	12	24	—	—	48	Non-ducted	11.3	11.3	22.5	—	—	12.0	12.0	24.0	—	12.0	45.0	48.0	0.80	4.28	4.77	
12	15	15	—	—	42	Non-ducted	12.0	15.0	15.0	—	—	12.8	16.0	16.0	—	12.0	42.0	44.8	0.80	3.92	4.36	
12	15	18	—	—	45	Non-ducted	12.0	15.0	18.0	—	—	12.8	16.0	19.2	—	12.0	45.0	48.0	0.80	4.28	4.77	
12	15	24	—	—	51	Non-ducted	10.6	13.2	21.2	—	—	11.3	14.1	22.6	—	12.0	45.0	48.0	0.80	4.28	4.77	
12	18	18	—	—	48	Non-ducted	11.3	16.9	16.9	—	—	12.0	18.0	18.0	—	12.0	45.0	48.0	0.80	4.46	4.77	
12	18	24	—	—	54	Non-ducted	10.0	15.0	20.0	—	—	10.7	16.0	21.3	—	12.0	45.0	48.0	0.80	4.46	4.77	
15	15	15	—	—	45	Non-ducted	15.0	15.0	15.0	—	—	16.0	16.0	16.0	—	12.0	45.0	48.0	0.80	4.46	4.77	
15	15	18	—	—	48	Non-ducted	14.1	14.1	16.9	—	—	15.0	15.0	18.0	—	12.0	45.0	48.0	0.80	4.46	4.77	
15	15	24	—	—	54	Non-ducted	12.5	12.5	20.0	—	—	13.3	13.3	21.3	—	12.0	45.0	48.0	0.80	4.46	4.77	
15	18	18	—	—	51	Non-ducted	13.2	15.9	15.9	—	—	14.1	16.9	16.9	—	12.0	45.0	48.0	0.80	4.46	4.77	
18	18	18	—	—	54	Non-ducted	15.0	15.0	15.0	—	—	16.0	16.0	16.0	—	12.0	45.0	48.0	0.80	4.46	4.77	
7	7	7	15	—	36	Non-ducted	7.0	7.0	7.0	15.0	—	7.5	7.5	7.5	16.0	—	12.0	36.0	38.4	0.80	3.14	3.42
7	7	7	18	—	39	Non-ducted	7.0	7.0	7.0	18.0	—	7.5	7.5	7.5	19.2	—	12.0	39.0	41.6	0.80	3.57	3.89
7	7	7	24	—	45	Non-ducted	7.0	7.0	7.0	24.0	—	7.5	7.5	7.5	25.6	—	12.0	45.0	48.0	0.80	4.37	4.77
7	7	9	12	—	35	Non-ducted	7.0	7.0	9.0	12.0	—	7.5	7.5	9.6	12.8	—	12.0	35.0	37.3	0.80	3.00	3.26
7	7	9	15	—	38	Non-ducted	7.0	7.0	9.0	15.0	—	7.5	7.5	9.6	16.0	—	12.0	38.0	40.5	0.80	3.43	3.73
7	7	9	18	—	41	Non-ducted	7.0	7.0	9.0	18.0	—	7.5	7.5	9.6	19.2	—	12.0	41.0	43.7	0.80	3.86	4.20
7	7	9	24	—	47	Non-ducted	6.7	6.7	8.6	23.0	—	7.1	7.1	9.2	24.5	—	12.0	45.0	48.0	0.80	4.37	4.77
7	7	12	12	—	38	Non-ducted	7.0	7.0	12.0	12.0	—	7.5	7.5	12.8	12.8	—	12.0	38.0	40.5	0.80	3.43	3.73
7	7	12	15	—	41	Non-ducted	7.0	7.0	12.0	15.0	—	7.5	7.5	12.8	16.0	—	12.0	41.0	43.7	0.80	3.86	4.20
7	7	12	18	—	44	Non-ducted	7.0	7.0	12.0	18.0	—	7.5	7.5	12.8	19.2	—	12.0	44.0	46.9	0.80	4.28	4.67
7	7	12	24	—	50	Non-ducted	6.3	6.3	10.8	21.6	—	6.7	6.7	11.5	23.0	—	12.0	45.0	48.0	0.80	4.37	4.77
7	7	15	15	—	44	Non-ducted	7.0	7.0	15.0	15.0	—	7.5	7.5	16.0	16.0	—	12.0	44.0	46.9	0.80	4.28	4.67
7	7	15	18	—	47	Non-ducted	6.7	6.7	14.4	17.2	—	7.1	7.1	15.3	18.4	—	12.0	45.0	48.0	0.80	4.28	4.77
7	7	15	24	—	53	Non-ducted	5.9	5.9	12.7	20.4	—	6.3	6.3	13.6	21.7	—	12.0	45.0	48.0	0.80	4.28	4.77
7	7	18	18	—	50	Non-ducted	6.3	6.3	16.2	16.2	—	6.7	6.7	17.3	17.3	—	12.0	45.0	48.0	0.80	4.28	4.77
7	9	9	9	—	34	Non-ducted	7.0	9.0	9.0	9.0	—	7.5	9.6	9.6	9.6	—	12.0	34.0	36.3	0.80	2.80	3.10
7	9	9	12	—	37	Non-ducted	7.0	9.0	9.0	12.0	—	7.5	9.6	9.6	12.8	—	12.0	37.0	39.5	0.80	3.22	3.58
7	9	9	15	—	40	Non-ducted	7.0	9.0	9.0	15.0	—	7.5	9.6	9.6	16.0	—	12.0	40.0	42.7	0.80	3.64	4.05
7	9	9	18	—	43	Non-ducted	7.0	9.0	9.0	18.0	—	7.5	9.6	9.6	19.2	—	12.0	43.0	45.9	0.80	3.30	4.52
7	9	9	24	—	49	Non-ducted	6.4	8.3	8.3	22.0	—	6.9	8.8	8.8	23.5	—	12.0	45.0	48.0	0.80	4.28	4.77
7	9	12	12	—	40	Non-ducted	7.0	9.0	12.0	12.0	—	7.5	9.6	12.8	12.8	—	12.0	40.0	42.7	0.80	3.64	4.05
7	9	12	15	—	43	Non-ducted	7.0	9.0	12.0	15.0	—	7.5	9.6	12.8	16.0	—	12.0	43.0	45.9	0.80	4.05	4.52
7	9	12	18	—	46	Non-ducted	6.8	8.8	11.7	17.6	—	7.3	9.4	12.5	18.8	—	12.0	45.0	48.0	0.80	4.28	4.77
7	9	12	24	—	52	Non-ducted	6.1	7.8	10.4	20.8	—	6.5	8.3	11.1	22.2	—	12.0	45.0	48.0	0.80	4.37	4.77
7	9	15	15	—	46	Non-ducted	6.8	8.8	14.7	14.7	—	7.3	9.4	15.7	15.7	—	12.0	45.0	48.0	0.80	4.37	4.77
7	9	15	18	—	49	Non-ducted	6.4	8.3	13.8	16.5	—	6.9	8.8	14.7	17.6	—	12.0	45.0	48.0	0.80	4.37	4.77
7	9	18	18	—	52	Non-ducted	6.1	7.8	15.6	15.6	—	6.5	8.3	16.6	16.6	—	12.0	45.0	48.0	0.80	4.37	4.77
7																						

Combination of indoor unit						Type of indoor unit	Rated capacity for each indoor unit [kBtu/h]					Maximum capacity for each indoor unit [kBtu/h]					Total capacity [kBtu/h]			Input power [kW]		
Room 1	Room 2	Room 3	Room 4	Room 5	Total		Room 1	Room 2	Room 3	Room 4	Room 5	Room 1	Room 2	Room 3	Room 4	Room 5	Min.	Rated	Max.	Min.	Rated	Max.
9	9	9	15	—	42	Non-ducted	9.0	9.0	9.0	15.0	—	9.6	9.6	9.6	16.0	—	12.0	42.0	44.8	0.80	4.00	4.36
9	9	9	18	—	45	Non-ducted	9.0	9.0	9.0	18.0	—	9.6	9.6	9.6	19.2	—	12.0	45.0	48.0	0.80	4.37	4.77
9	9	9	24	—	51	Non-ducted	7.9	7.9	7.9	21.2	—	8.5	8.5	8.5	22.6	—	12.0	45.0	48.0	0.80	4.37	4.77
9	9	12	12	—	42	Non-ducted	9.0	9.0	12.0	12.0	—	9.6	9.6	12.8	12.8	—	12.0	42.0	44.8	0.80	4.00	4.36
9	9	12	15	—	45	Non-ducted	9.0	9.0	12.0	15.0	—	9.6	9.6	12.8	16.0	—	12.0	45.0	48.0	0.80	4.37	4.77
9	9	12	18	—	48	Non-ducted	8.4	8.4	11.3	16.9	—	9.0	9.0	12.0	18.0	—	12.0	45.0	48.0	0.80	4.37	4.77
9	9	12	24	—	54	Non-ducted	7.5	7.5	10.0	20.0	—	8.0	8.0	10.7	21.3	—	12.0	45.0	48.0	0.80	4.37	4.77
9	9	15	15	—	48	Non-ducted	8.4	8.4	14.1	14.1	—	9.0	9.0	15.0	15.0	—	12.0	45.0	48.0	0.80	4.28	4.77
9	9	15	18	—	51	Non-ducted	7.9	7.9	13.2	15.9	—	8.5	8.5	14.1	16.9	—	12.0	45.0	48.0	0.80	4.28	4.77
9	9	18	18	—	54	Non-ducted	7.5	7.5	15.0	15.0	—	8.0	8.0	16.0	16.0	—	12.0	45.0	48.0	0.80	4.28	4.77
9	12	12	12	—	45	Non-ducted	9.0	12.0	12.0	12.0	—	9.6	12.8	12.8	12.8	—	12.0	45.0	48.0	0.80	4.28	4.77
9	12	12	15	—	48	Non-ducted	8.4	11.3	11.3	14.1	—	9.0	12.0	12.0	15.0	—	12.0	45.0	48.0	0.80	4.28	4.77
9	12	12	18	—	51	Non-ducted	7.9	10.6	10.6	15.9	—	8.5	11.3	11.3	16.9	—	12.0	45.0	48.0	0.80	4.28	4.77
9	12	15	15	—	51	Non-ducted	7.9	10.6	13.2	13.2	—	8.5	11.3	14.1	14.1	—	12.0	45.0	48.0	0.80	3.45	4.77
9	12	15	18	—	54	Non-ducted	7.5	10.0	12.5	15.0	—	8.0	10.7	13.3	16.0	—	12.0	45.0	48.0	0.80	4.28	4.77
12	12	12	12	—	48	Non-ducted	11.3	11.3	11.3	11.3	—	12.0	12.0	12.0	12.0	—	12.0	45.0	48.0	0.80	4.28	4.77
12	12	12	15	—	51	Non-ducted	10.6	10.6	10.6	13.2	—	11.3	11.3	11.3	14.1	—	12.0	45.0	48.0	0.80	4.28	4.77
12	12	12	18	—	54	Non-ducted	10.0	10.0	10.0	15.0	—	10.7	10.7	10.7	16.0	—	12.0	45.0	48.0	0.80	4.28	4.77
12	12	12	18	—	54	Non-ducted	10.0	10.0	10.0	15.0	—	10.7	10.7	10.7	16.0	—	12.0	45.0	48.0	0.80	4.37	4.77
12	12	15	15	—	54	Non-ducted	10.0	10.0	12.5	12.5	—	10.7	10.7	13.3	13.3	—	12.0	45.0	48.0	0.80	4.37	4.77
7	7	7	7	7	35	Non-ducted	7.0	7.0	7.0	7.0	7.0	7.5	7.5	7.5	7.5	7.5	12.0	35.0	37.3	0.80	2.94	3.26
7	7	7	7	9	37	Non-ducted	7.0	7.0	7.0	7.0	9.0	7.5	7.5	7.5	7.5	9.6	12.0	37.0	39.5	0.80	3.22	3.58
7	7	7	7	12	40	Non-ducted	7.0	7.0	7.0	7.0	12.0	7.5	7.5	7.5	7.5	12.8	12.0	40.0	42.7	0.80	3.64	4.05
7	7	7	7	15	43	Non-ducted	7.0	7.0	7.0	7.0	15.0	7.5	7.5	7.5	7.5	16.0	12.0	43.0	45.9	0.80	4.05	4.52
7	7	7	7	18	46	Non-ducted	6.8	6.8	6.8	6.8	17.6	7.3	7.3	7.3	7.3	18.8	12.0	45.0	48.0	0.80	4.28	4.77
7	7	7	7	24	52	Non-ducted	6.1	6.1	6.1	6.1	20.8	6.5	6.5	6.5	6.5	22.2	12.0	45.0	48.0	0.80	4.28	4.77
7	7	7	9	9	39	Non-ducted	7.0	7.0	7.0	9.0	9.0	7.5	7.5	7.5	9.6	9.6	12.0	39.0	41.6	0.80	3.50	3.89
7	7	7	9	12	42	Non-ducted	7.0	7.0	7.0	9.0	12.0	7.5	7.5	7.5	9.6	12.8	12.0	42.0	44.8	0.80	3.92	4.36
7	7	7	9	15	45	Non-ducted	7.0	7.0	7.0	9.0	15.0	7.5	7.5	7.5	9.6	16.0	12.0	45.0	48.0	0.80	4.28	4.77
7	7	7	9	18	48	Non-ducted	6.6	6.6	6.6	8.4	16.9	7.0	7.0	7.0	9.0	18.0	12.0	45.0	48.0	0.80	4.28	4.77
7	7	7	9	24	54	Non-ducted	5.8	5.8	5.8	7.5	20.0	6.2	6.2	6.2	8.0	21.3	12.0	45.0	48.0	0.80	4.28	4.77
7	7	7	12	12	45	Non-ducted	7.0	7.0	7.0	12.0	12.0	7.5	7.5	7.5	12.8	12.8	12.0	45.0	48.0	0.80	4.28	4.77
7	7	7	12	15	48	Non-ducted	6.6	6.6	6.6	11.3	14.1	7.0	7.0	7.0	12.0	15.0	12.0	45.0	48.0	0.80	4.28	4.77
7	7	7	12	18	51	Non-ducted	6.2	6.2	6.2	10.6	15.9	6.6	6.6	6.6	11.3	16.9	12.0	45.0	48.0	0.80	4.28	4.77
7	7	7	15	15	51	Non-ducted	6.2	6.2	6.2	13.2	13.2	6.6	6.6	6.6	14.1	14.1	12.0	45.0	48.0	0.80	4.28	4.77
7	7	7	15	18	54	Non-ducted	5.8	5.8	5.8	12.5	15.0	6.2	6.2	6.2	13.3	16.0	12.0	45.0	48.0	0.80	4.28	4.77
7	7	9	9	9	41	Non-ducted	7.0	7.0	9.0	9.0	9.0	7.5	7.5	9.6	9.6	9.6	12.0	41.0	43.7	0.80	3.78	4.20
7	7	9	9	12	44	Non-ducted	7.0	7.0	9.0	9.0	12.0	7.5	7.5	9.6	9.6	12.8	12.0	44.0	46.9	0.80	4.20	4.67
7	7	9	9	15	47	Non-ducted	6.7	6.7	8.6	8.6	14.4	7.1	7.1	9.2	9.2	15.3	12.0	45.0	48.0	0.80	4.28	4.77
7	7	9	9	18	50	Non-ducted	6.3	6.3	8.1	8.1	16.2	6.7	6.7	8.6	8.6	17.3	12.0	45.0	48.0	0.80	4.28	4.77
7	7	9	12	12	47	Non-ducted	6.7	6.7	8.6	11.5	11.5	7.1	7.1	9.2	12.3	12.3	12.0	45.0	48.0	0.80	4.28	4.77
7	7	9	12	15	50	Non-ducted	6.3	6.3	8.1	10.8	13.5	6.7	6.7	8.6	11.5	14.4	12.0	45.0	48.0	0.80	4.28	4.77
7	7	9	12	18	53	Non-ducted	5.9	5.9	7.6	10.2	15.3	6.3	6.3	8.2	10.9	16.3	12.0	45.0	48.0	0.80	4.28	4.77
7	7	9	15	15	53	Non-ducted	5.9	5.9	7.6	12.7	12.7	6.3	6.3	8.2	13.6	13.6	12.0	45.0	48.0	0.80	3.45	4.77
7	7	12	12	12	50	Non-ducted	6.3	6.3	10.8	10.8	10.8	6.7	6.7	11.5	11.5	11.5	12.0	45.0	48.0	0.80	4.28	4.77
7	7	12	12	15	53	Non-ducted	5.9	5.9	10.2	10.2	12.7	6.3	6.3	10.9	10.9	13.6	12.0	45.0	48.0	0.80	4.28	4.77
7	9	9	9	9	43	Non-ducted	7.0	9.0	9.0	9.0	9.0	7.5	9.6	9.6	9.6	9.6	12.0	43.0	45.9	0.80	4.05	4.52
7	9	9	9	12	46	Non-ducted	6.8	8.8	8.8	8.8	11.7	7.3	9.4	9.4	9.4	12.5	12.0	45.0	48.0	0.80	4.28	4.77
7	9	9	9	15	49	Non-ducted	6.4	8.3	8.3	8.3	13.8	6.9	8.8	8.8	8.8	14.7	12.0	45.0	48.0	0.80	4.28	4.77
7	9	9	9	18	52	Non-ducted	6.1	7.8	7.8	7.8	15.6	6.5	8.3	8.3	8.3	16.6	12.0	45.0	48.0	0.80	4.28	4.77
7	9	9	12	12	49	Non-ducted	6.4	8.3	8.3	11.0	11.0	6.9	8.8	8.8	11.8	11.8	12.0	45.0	48.0	0.80	4.28	4.77
7	9	9	12	15	52	Non-ducted	6.1	7.8	7.8	10.4	13.0	6.5	8.3	8.3	11.1	13.8	12.0	45.0	48.0	0.80	4.28	4.77
7	9	12	12	12	52	Non-ducted	6.1	7.8	10.4	10.4	10.4	6.5	8.3	11.1	11.1	11.1	12.0	45.0	48.0	0.80	4.28	4.77
9	9	9	9	9	45	Non-ducted	9.0	9.0	9.0	9.0	9.0	9.6	9.6	9.6	9.6	9.6	12.0	45.0	48.0	0.80	4.28	4.77
9	9	9	9	12	48	Non-ducted	8.4	8.4	8.4	8.4	11.3	9.0	9.0	9.0	9.0	12.0	12.0	45.0	48.0	0.80	4.36	4.86
9	9	9	9	15	51	Non-ducted	7.9	7.9	7.9	7.9	13.2	8.5	8.5	8.5	14.1	14.1	12.0	45.0	48.0	0.80	4.36	4.86
9	9	9	9	18	54	Non-ducted	7.5	7.5	7.5	7.5	15.0	8.0	8.0	8.0	8.0	16.0	12.0	45.0	48.0	0.80	4.36	4.86
9	9	9	12	12	51	Non-ducted	7.9	7.9	7.9	10.6	10.6	8.5	8.5	8.5	11.3	11.3	12.0	45.0	48.0	0.80	4.36	4.86
9	9	9	12	15	54	Non-ducted	7.5	7.5	7.5	10.0	12.5	8.0	8.0	8.0	10.7	13.3	12.0	45.0	48.0	0.80	4.36	4.86
9	9	12	12	12	54	Non-ducted	7.5	7.5	10.0	10.0	10.0	8.0	8.0	10.7	10.7	10.7	12.0	45.0	48.0	0.80	4.36	4.86

**NOTES:**

- Specifications are based on the following conditions.
  - Power source of specifications: 230 V
  - 7: 7,000 Btu/h, 9: 9,000 Btu/h, 12: 12,000 Btu/h, 15: 14,000 Btu/h, 18: 18,000 Btu/h, 24: 24,000 Btu/h
  - 2 or more indoor units should be connected.
  - Cooling: Indoor temperature of 80 °FDB (26.7 °CDB)/ 67 °FWB (19.4 °CWB), and outdoor temperature of 95 °FDB (35 °CDB) / 75 °FWB (23.9 °CWB).
  - Pipe length: 24.6 ft (7.5 m), Height difference: 0 ft (0 m) [Outdoor unit - Indoor unit]
  - The total ability of connected a indoor unit is from 34,000 Btu up to 54,000 Btu.
- Combination of 15+24 (14,000 Btu/h+24,000 Btu/h) of the indoor units is prohibited.



# Model: ROMH45AFXZJ

## ● Heating

Combination of indoor unit						Type of indoor unit	Rated capacity for each indoor unit [kBtu/h]					Maximum capacity for each indoor unit [kBtu/h]					Total capacity [kBtu/h]			Input power [kW]		
Room 1	Room 2	Room 3	Room 4	Room 5	Total		Room 1	Room 2	Room 3	Room 4	Room 5	Room 1	Room 2	Room 3	Room 4	Room 5	Min.	Rated	Max.	Min.	Rated	Max.
18	18	—	—	—	36	Non-ducted	19.2	19.2	—	—	21.6	21.6	—	—	—	12.0	38.4	43.2	0.70	3.24	3.39	
12	24	—	—	—	36	Non-ducted	12.8	25.6	—	—	14.4	28.8	—	—	—	12.0	38.4	43.2	0.70	3.24	3.39	
15	24	—	—	—	39	Non-ducted	16.0	25.6	—	—	18.0	28.8	—	—	—	12.0	41.6	46.8	0.70	3.53	3.70	
18	24	—	—	—	42	Non-ducted	19.2	25.6	—	—	21.6	28.8	—	—	—	12.0	44.8	50.4	0.70	3.83	4.01	
24	24	—	—	—	48	Non-ducted	24.0	24.0	—	—	27.0	27.0	—	—	—	12.0	48.0	54.0	0.70	4.13	4.32	
7	7	24	—	—	38	Non-ducted	7.5	7.5	25.6	—	8.4	8.4	28.8	—	—	12.0	40.5	45.6	0.70	3.36	3.60	
7	9	18	—	—	34	Non-ducted	7.5	9.6	19.2	—	8.4	10.8	21.6	—	—	12.0	36.3	40.8	0.70	2.98	3.19	
7	9	24	—	—	40	Non-ducted	7.5	9.6	25.6	—	8.4	10.8	28.8	—	—	12.0	42.7	48.0	0.70	3.56	3.80	
7	12	18	—	—	37	Non-ducted	7.5	12.8	19.2	—	8.4	14.4	21.6	—	—	12.0	39.5	44.4	0.70	3.27	3.49	
7	12	24	—	—	43	Non-ducted	7.5	12.8	25.6	—	8.4	14.4	28.8	—	—	12.0	45.9	51.6	0.70	3.85	4.12	
7	15	15	—	—	37	Non-ducted	7.5	16.0	16.0	—	8.4	18.0	18.0	—	—	12.0	39.5	44.4	0.70	3.27	3.49	
7	15	18	—	—	40	Non-ducted	7.5	16.0	19.2	—	8.4	18.0	21.6	—	—	12.0	42.7	48.0	0.70	3.56	3.80	
7	15	24	—	—	46	Non-ducted	7.3	15.7	25.0	—	8.2	17.6	28.2	—	—	12.0	48.0	54.0	0.70	4.04	4.32	
7	18	18	—	—	43	Non-ducted	7.5	19.2	19.2	—	8.4	21.6	21.6	—	—	12.0	45.9	51.6	0.70	3.85	4.12	
7	18	24	—	—	49	Non-ducted	6.9	17.6	23.5	—	7.7	19.8	26.4	—	—	12.0	48.0	54.0	0.70	4.04	4.32	
9	9	18	—	—	36	Non-ducted	9.6	9.6	19.2	—	10.8	10.8	21.6	—	—	12.0	38.4	43.2	0.70	3.17	3.39	
9	9	24	—	—	42	Non-ducted	9.6	9.6	25.6	—	10.8	10.8	28.8	—	—	12.0	44.8	50.4	0.70	3.75	4.01	
9	12	15	—	—	36	Non-ducted	9.6	12.8	16.0	—	10.8	14.4	18.0	—	—	12.0	38.4	43.2	0.70	3.17	3.39	
9	12	18	—	—	39	Non-ducted	9.6	12.8	19.2	—	10.8	14.4	21.6	—	—	12.0	41.6	46.8	0.70	3.46	3.70	
9	12	24	—	—	45	Non-ducted	9.6	12.8	25.6	—	10.8	14.4	28.8	—	—	12.0	48.0	54.0	0.70	4.04	4.32	
9	15	15	—	—	39	Non-ducted	9.6	16.0	16.0	—	10.8	18.0	18.0	—	—	12.0	41.6	46.8	0.70	3.46	3.70	
9	15	18	—	—	42	Non-ducted	9.6	16.0	19.2	—	10.8	18.0	21.6	—	—	12.0	44.8	50.4	0.70	3.60	4.01	
9	15	24	—	—	48	Non-ducted	9.0	15.0	24.0	—	10.1	16.9	27.0	—	—	12.0	48.0	54.0	0.70	3.88	4.32	
9	18	18	—	—	45	Non-ducted	9.6	19.2	19.2	—	10.8	21.6	21.6	—	—	12.0	48.0	54.0	0.70	3.88	4.32	
9	18	24	—	—	51	Non-ducted	8.5	16.9	22.6	—	9.5	19.1	25.4	—	—	12.0	48.0	54.0	0.70	3.88	4.32	
12	12	12	—	—	36	Non-ducted	12.8	12.8	12.8	—	14.4	14.4	14.4	—	—	12.0	38.4	43.2	0.70	3.04	3.39	
12	12	15	—	—	39	Non-ducted	12.8	12.8	16.0	—	14.4	14.4	18.0	—	—	12.0	41.6	46.8	0.70	3.32	3.70	
12	12	18	—	—	42	Non-ducted	12.8	12.8	19.2	—	14.4	14.4	21.6	—	—	12.0	44.8	50.4	0.70	3.44	4.01	
12	12	24	—	—	48	Non-ducted	12.0	12.0	24.0	—	13.5	13.5	27.0	—	—	12.0	48.0	54.0	0.70	3.88	4.32	
12	15	15	—	—	42	Non-ducted	12.8	16.0	16.0	—	14.4	18.0	18.0	—	—	12.0	44.8	50.4	0.70	3.60	4.01	
12	15	18	—	—	45	Non-ducted	12.8	16.0	19.2	—	14.4	18.0	21.6	—	—	12.0	48.0	54.0	0.70	3.88	4.32	
12	15	24	—	—	51	Non-ducted	11.3	14.1	22.6	—	12.7	15.9	25.4	—	—	12.0	48.0	54.0	0.70	3.88	4.32	
12	18	18	—	—	48	Non-ducted	12.0	18.0	18.0	—	13.5	20.3	20.3	—	—	12.0	48.0	54.0	0.70	4.04	4.32	
12	18	24	—	—	54	Non-ducted	10.7	16.0	21.3	—	12.0	18.0	24.0	—	—	12.0	48.0	54.0	0.70	4.04	4.32	
15	15	15	—	—	45	Non-ducted	16.0	16.0	16.0	—	18.0	18.0	18.0	—	—	12.0	48.0	54.0	0.70	4.04	4.32	
15	15	18	—	—	48	Non-ducted	15.0	15.0	18.0	—	16.9	16.9	20.3	—	—	12.0	48.0	54.0	0.70	4.04	4.32	
15	15	24	—	—	54	Non-ducted	13.3	13.3	21.3	—	15.0	15.0	24.0	—	—	12.0	48.0	54.0	0.70	4.04	4.32	
15	18	18	—	—	51	Non-ducted	14.1	16.9	16.9	—	15.9	19.1	19.1	—	—	12.0	48.0	54.0	0.70	4.04	4.32	
18	18	18	—	—	54	Non-ducted	16.0	16.0	16.0	—	18.0	18.0	18.0	—	—	12.0	48.0	54.0	0.70	4.04	4.32	
7	7	7	15	—	36	Non-ducted	7.5	7.5	7.5	16.0	8.4	8.4	8.4	18.0	—	12.0	38.4	43.2	0.70	3.11	3.39	
7	7	7	18	—	39	Non-ducted	7.5	7.5	7.5	19.2	8.4	8.4	8.4	21.6	—	12.0	41.6	46.8	0.70	3.39	3.70	
7	7	7	24	—	45	Non-ducted	7.5	7.5	7.5	25.6	8.4	8.4	8.4	28.8	—	12.0	48.0	54.0	0.70	3.96	4.32	
7	7	9	12	—	35	Non-ducted	7.5	7.5	9.6	12.8	8.4	8.4	10.8	14.4	—	12.0	37.3	42.0	0.70	3.01	3.29	
7	7	9	15	—	38	Non-ducted	7.5	7.5	9.6	16.0	8.4	8.4	10.8	18.0	—	12.0	40.5	45.6	0.70	3.29	3.60	
7	7	9	18	—	41	Non-ducted	7.5	7.5	9.6	19.2	8.4	8.4	10.8	21.6	—	12.0	43.7	49.2	0.70	3.58	3.91	
7	7	9	24	—	47	Non-ducted	7.1	7.1	9.2	24.5	8.0	8.0	10.3	27.6	—	12.0	48.0	54.0	0.70	3.96	4.32	
7	7	12	12	—	38	Non-ducted	7.5	7.5	12.8	12.8	8.4	8.4	14.4	14.4	—	12.0	40.5	45.6	0.70	3.29	3.60	
7	7	12	15	—	41	Non-ducted	7.5	7.5	12.8	16.0	8.4	8.4	14.4	18.0	—	12.0	43.7	49.2	0.70	3.58	3.91	
7	7	12	18	—	44	Non-ducted	7.5	7.5	12.8	19.2	8.4	8.4	14.4	21.6	—	12.0	46.9	52.8	0.70	3.86	4.22	
7	7	12	24	—	50	Non-ducted	6.7	6.7	11.5	23.0	7.6	7.6	13.0	25.9	—	12.0	48.0	54.0	0.70	3.96	4.32	
7	7	15	15	—	44	Non-ducted	7.5	7.5	16.0	16.0	8.4	8.4	18.0	18.0	—	12.0	46.9	52.8	0.70	3.86	4.22	
7	7	15	18	—	47	Non-ducted	7.1	7.1	15.3	18.4	8.0	8.0	17.2	20.7	—	12.0	48.0	54.0	0.70	3.88	4.32	
7	7	15	24	—	53	Non-ducted	6.3	6.3	13.6	21.7	7.1	7.1	15.3	24.5	—	12.0	48.0	54.0	0.70	3.88	4.32	
7	7	18	18	—	50	Non-ducted	6.7	6.7	17.3	17.3	7.6	7.6	19.4	19.4	—	12.0	48.0	54.0	0.70	3.88	4.32	
7	9	9	9	—	34	Non-ducted	7.5	9.6	9.6	9.6	8.4	10.8	10.8	10.8	—	12.0	36.3	40.8	0.70	2.86	3.19	
7	9	9	12	—	37	Non-ducted	7.5	9.6	9.6	12.8	8.4	10.8	10.8	14.4	—	12.0	39.5	44.4	0.70	3.14	3.49	
7	9	9	15	—	40	Non-ducted	7.5	9.6	9.6	16.0	8.4	10.8	10.8	18.0	—	12.0	42.7	48.0	0.70	3.42	3.80	
7	9	9	18	—	43	Non-ducted	7.5	9.6	9.6	19.2	8.4	10.8	10.8	21.6	—	12.0	45.9	51.6	0.70	3.52	4.12	
7	9	9	24	—	49	Non-ducted	6.9	8.8	8.8	23.5	7.7	9.9	9.9	26.4	—	12.0	48.0	54.0	0.70	3.88	4.32	
7	9	12	12	—	40	Non-ducted	7.5	9.6	12.8	12.8	8.4	10.8	14.4	14.4	—	12.0	42.7	48.0	0.70	3.42	3.80	
7	9	12	15	—	43	Non-ducted	7.5	9.6	12.8	16.0	8.4	10.8	14.4	18.0	—	12.0	45.9	51.6	0.70	3.70	4.12	
7	9	12	18	—	46	Non-ducted	7.3	9.4	12.5	18.8	8.2	10.6	14.1	21.1	—	12.0	48.0	54.0	0.70	3.88	4.32	
7	9	12	24	—	52	Non-ducted	6.5	8.3	11.1	22.2	7.3	9.3	12.5	24.9	—	12.0	48.0	54.0	0.70	3.96	4.32	
7	9	15	15	—	46	Non-ducted	7.3	9.4	15.7	15.7	8.2	10.6	17.6	17.6	—	12.0	48.0	54.0	0.70	3.96	4.32	
7	9	15	18	—	49	Non-ducted	6.9	8.8	14.7	17.6	7.7	9.9	16.5	19.8	—	12.0	48.0	54.0	0.70	3.96	4.32	
7	9	18	18	—	52	Non-ducted	6.5	8.3	16.6	16.6	7.3	9.3	18.7	18.7	—	12.0	48.0	54.0	0.70	3.96	4.32	
7	12	12	12	—	43	Non-ducted	7.5	12.8	12.8	12.8	8.4	14.4	14.4	14.4	—	12.0	45.9	51.6	0.70	3.77	4.12	
7	12	12	15	—	46	Non-ducted	7.3															

Combination of indoor unit						Type of indoor unit	Rated capacity for each indoor unit [kBtu/h]					Maximum capacity for each indoor unit [kBtu/h]					Total capacity [kBtu/h]			Input power [kW]		
Room 1	Room 2	Room 3	Room 4	Room 5	Total		Room 1	Room 2	Room 3	Room 4	Room 5	Room 1	Room 2	Room 3	Room 4	Room 5	Min.	Rated	Max.	Min.	Rated	Max.
9	9	15	18	—	51	Non-ducted	8.5	8.5	14.1	16.9	—	9.5	9.5	15.9	19.1	—	12.0	48.0	54.0	0.70	3.88	4.32
9	9	18	18	—	54	Non-ducted	8.0	8.0	16.0	16.0	—	9.0	9.0	18.0	18.0	—	12.0	48.0	54.0	0.70	3.88	4.32
9	12	12	12	—	45	Non-ducted	9.6	12.8	12.8	12.8	—	10.8	14.4	14.4	14.4	—	12.0	48.0	54.0	0.70	3.88	4.32
9	12	12	15	—	48	Non-ducted	9.0	12.0	12.0	15.0	—	10.1	13.5	13.5	16.9	—	12.0	48.0	54.0	0.70	3.88	4.32
9	12	12	18	—	51	Non-ducted	8.5	11.3	11.3	16.9	—	9.5	12.7	12.7	19.1	—	12.0	48.0	54.0	0.70	3.88	4.32
9	12	15	15	—	51	Non-ducted	8.5	11.3	14.1	14.1	—	9.5	12.7	15.9	15.9	—	12.0	48.0	54.0	0.70	3.88	4.32
9	12	15	18	—	54	Non-ducted	8.0	10.7	13.3	16.0	—	9.0	12.0	15.0	18.0	—	12.0	48.0	54.0	0.70	3.88	4.32
12	12	12	12	—	48	Non-ducted	12.0	12.0	12.0	12.0	—	13.5	13.5	13.5	13.5	—	12.0	48.0	54.0	0.70	3.88	4.32
12	12	12	15	—	51	Non-ducted	11.3	11.3	11.3	14.1	—	12.7	12.7	12.7	15.9	—	12.0	48.0	54.0	0.70	3.88	4.32
12	12	12	18	—	54	Non-ducted	10.7	10.7	10.7	16.0	—	12.0	12.0	12.0	18.0	—	12.0	48.0	54.0	0.70	3.88	4.32
12	12	12	18	—	54	Non-ducted	10.7	10.7	10.7	16.0	—	12.0	12.0	12.0	18.0	—	12.0	48.0	54.0	0.70	3.96	4.32
12	12	15	15	—	54	Non-ducted	10.7	10.7	13.3	13.3	—	12.0	12.0	15.0	15.0	—	12.0	48.0	54.0	0.70	3.96	4.32
7	7	7	7	7	35	Non-ducted	7.5	7.5	7.5	7.5	7.5	8.4	8.4	8.4	8.4	8.4	12.0	37.3	42.0	0.70	2.95	3.29
7	7	7	7	9	37	Non-ducted	7.5	7.5	7.5	7.5	9.6	8.4	8.4	8.4	8.4	10.8	12.0	39.5	44.4	0.70	3.14	3.49
7	7	7	7	12	40	Non-ducted	7.5	7.5	7.5	7.5	12.8	8.4	8.4	8.4	8.4	14.4	12.0	42.7	48.0	0.70	3.42	3.80
7	7	7	7	15	43	Non-ducted	7.5	7.5	7.5	7.5	16.0	8.4	8.4	8.4	8.4	18.0	12.0	45.9	51.6	0.70	3.70	4.12
7	7	7	7	18	46	Non-ducted	7.3	7.3	7.3	7.3	18.8	8.2	8.2	8.2	8.2	21.1	12.0	48.0	54.0	0.70	3.88	4.32
7	7	7	7	24	52	Non-ducted	6.5	6.5	6.5	6.5	22.2	7.3	7.3	7.3	7.3	24.9	12.0	48.0	54.0	0.70	3.88	4.32
7	7	7	9	9	39	Non-ducted	7.5	7.5	7.5	9.6	9.6	8.4	8.4	8.4	10.8	10.8	12.0	41.6	46.8	0.70	3.32	3.70
7	7	7	9	12	42	Non-ducted	7.5	7.5	7.5	9.6	12.8	8.4	8.4	8.4	10.8	14.4	12.0	44.8	50.4	0.70	3.60	4.01
7	7	7	9	15	45	Non-ducted	7.5	7.5	7.5	9.6	16.0	8.4	8.4	8.4	10.8	18.0	12.0	48.0	54.0	0.70	3.88	4.32
7	7	7	9	18	48	Non-ducted	7.0	7.0	7.0	9.0	18.0	7.9	7.9	7.9	10.1	20.3	12.0	48.0	54.0	0.70	3.88	4.32
7	7	7	9	24	54	Non-ducted	6.2	6.2	6.2	8.0	21.3	7.0	7.0	7.0	9.0	24.0	12.0	48.0	54.0	0.70	3.88	4.32
7	7	7	12	12	45	Non-ducted	7.5	7.5	7.5	12.8	12.8	8.4	8.4	8.4	14.4	14.4	12.0	48.0	54.0	0.70	3.88	4.32
7	7	7	12	15	48	Non-ducted	7.0	7.0	7.0	12.0	15.0	7.9	7.9	7.9	13.5	16.9	12.0	48.0	54.0	0.70	3.88	4.32
7	7	7	12	18	51	Non-ducted	6.6	6.6	6.6	11.3	16.9	7.4	7.4	7.4	12.7	19.1	12.0	48.0	54.0	0.70	3.88	4.32
7	7	7	15	15	51	Non-ducted	6.6	6.6	6.6	14.1	14.1	7.4	7.4	7.4	15.9	15.9	12.0	48.0	54.0	0.70	3.88	4.32
7	7	7	15	18	54	Non-ducted	6.2	6.2	6.2	13.3	16.0	7.0	7.0	7.0	15.0	18.0	12.0	48.0	54.0	0.70	3.88	4.32
7	7	9	9	9	41	Non-ducted	7.5	7.5	9.6	9.6	9.6	8.4	8.4	10.8	10.8	10.8	12.0	43.7	49.2	0.70	3.51	3.91
7	7	9	9	12	44	Non-ducted	7.5	7.5	9.6	9.6	12.8	8.4	8.4	10.8	10.8	14.4	12.0	46.9	52.8	0.70	3.78	4.22
7	7	9	9	15	47	Non-ducted	7.1	7.1	9.2	9.2	15.3	8.0	8.0	10.3	10.3	17.2	12.0	48.0	54.0	0.70	3.88	4.32
7	7	9	9	18	50	Non-ducted	6.7	6.7	8.6	8.6	17.3	7.6	7.6	9.7	9.7	19.4	12.0	48.0	54.0	0.70	3.88	4.32
7	7	9	12	12	47	Non-ducted	7.1	7.1	9.2	12.3	12.3	8.0	8.0	10.3	13.8	13.8	12.0	48.0	54.0	0.70	3.88	4.32
7	7	9	12	15	50	Non-ducted	6.7	6.7	8.6	11.5	14.4	7.6	7.6	9.7	13.0	16.2	12.0	48.0	54.0	0.70	3.88	4.32
7	7	9	12	18	53	Non-ducted	6.3	6.3	8.2	10.9	16.3	7.1	7.1	9.2	12.2	18.3	12.0	48.0	54.0	0.70	3.88	4.32
7	7	9	15	15	53	Non-ducted	6.3	6.3	8.2	13.6	13.6	7.1	7.1	9.2	15.3	15.3	12.0	48.0	54.0	0.70	3.68	4.32
7	7	12	12	12	50	Non-ducted	6.7	6.7	11.5	11.5	11.5	7.6	7.6	13.0	13.0	13.0	12.0	48.0	54.0	0.70	3.88	4.32
7	7	12	12	15	53	Non-ducted	6.3	6.3	10.9	10.9	13.6	7.1	7.1	12.2	12.2	15.3	12.0	48.0	54.0	0.70	3.88	4.32
7	9	9	9	9	43	Non-ducted	7.5	9.6	9.6	9.6	9.6	8.4	10.8	10.8	10.8	10.8	12.0	45.9	51.6	0.70	3.70	4.12
7	9	9	9	12	46	Non-ducted	7.3	9.4	9.4	9.4	12.5	8.2	10.6	10.6	10.6	14.1	12.0	48.0	54.0	0.70	3.88	4.32
7	9	9	9	15	49	Non-ducted	6.9	8.8	8.8	8.8	14.7	7.7	9.9	9.9	9.9	16.5	12.0	48.0	54.0	0.70	3.88	4.32
7	9	9	9	18	52	Non-ducted	6.5	8.3	8.3	8.3	16.6	7.3	9.3	9.3	9.3	18.7	12.0	48.0	54.0	0.70	3.88	4.32
7	9	9	12	12	49	Non-ducted	6.9	8.8	8.8	11.8	11.8	7.7	9.9	9.9	13.2	13.2	12.0	48.0	54.0	0.70	3.88	4.32
7	9	9	12	15	52	Non-ducted	6.5	8.3	8.3	11.1	13.8	7.3	9.3	9.3	12.5	15.6	12.0	48.0	54.0	0.70	3.88	4.32
7	9	12	12	12	52	Non-ducted	6.5	8.3	11.1	11.1	11.1	7.3	9.3	12.5	12.5	12.5	12.0	48.0	54.0	0.70	3.88	4.32
9	9	9	9	9	45	Non-ducted	9.6	9.6	9.6	9.6	9.6	10.8	10.8	10.8	10.8	10.8	12.0	48.0	54.0	0.70	3.88	4.32
9	9	9	9	12	48	Non-ducted	9.0	9.0	9.0	9.0	12.0	10.1	10.1	10.1	10.1	13.5	12.0	48.0	54.0	0.70	3.88	4.32
9	9	9	9	15	51	Non-ducted	8.5	8.5	8.5	8.5	14.1	9.5	9.5	9.5	9.5	15.9	12.0	48.0	54.0	0.70	3.88	4.32
9	9	9	9	18	54	Non-ducted	8.0	8.0	8.0	8.0	16.0	9.0	9.0	9.0	9.0	18.0	12.0	48.0	54.0	0.70	3.88	4.32
9	9	9	12	12	51	Non-ducted	8.5	8.5	8.5	11.3	11.3	9.5	9.5	9.5	12.7	12.7	12.0	48.0	54.0	0.70	3.88	4.32
9	9	9	12	15	54	Non-ducted	8.0	8.0	8.0	10.7	13.3	9.0	9.0	9.0	12.0	15.0	12.0	48.0	54.0	0.70	3.88	4.32
9	9	12	12	12	54	Non-ducted	8.0	8.0	10.7	10.7	10.7	9.0	9.0	12.0	12.0	12.0	12.0	48.0	54.0	0.70	3.88	4.32

**NOTES:**

- Specifications are based on the following conditions.
  - Power source of specifications: 230 V
  - 7: 7,000 Btu/h, 9: 9,000 Btu/h, 12: 12,000 Btu/h, 15: 14,000 Btu/h, 18: 18,000 Btu/h, 24: 24,000 Btu/h
  - 2 or more indoor units should be connected.
  - Heating: Indoor temperature of 70 °FDB (21.1 °CDB) / 60 °FWB (15.6 °CWB), and outdoor temperature of 47 °FDB (8.3 °CDB) / 43 °FWB (6.1 °CWB).
  - Pipe length: 24.6 ft (7.5 m), Height difference: 0 ft (0 m) [Outdoor unit - Indoor unit]
  - The total ability of connected a indoor unit is from 34,000 Btu up to 54,000 Btu.
- Combination of 15+24 (14,000 Btu/h+24,000 Btu/h) of the indoor units is prohibited.

# 6-2. Cooling capacity

## Model: ROMH45AFXZJ

NOTE: Values mentioned in the table are calculated based on the maximum capacity.

### Cooling

TC: Total Capacity (kBtu/h), IP: Input Power (kW)

Indoor unit connecting capacity	Outdoor temperature	Indoor temperature											
		64 °FDB		70 °FDB		75 °FDB		80 °FDB		85 °FDB		90 °FDB	
		54 °FWB		60 °FWB		63 °FWB		67 °FWB		71 °FWB		73 °FWB	
kBtu/h	°FDB	TC	IP	TC	IP	TC	IP	TC	IP	TC	IP	TC	IP
54	14	37.6	1.55	42.5	1.58	44.8	1.59	48.0	1.61	51.3	1.63	52.9	1.64
	23	37.6	1.62	42.5	1.65	44.8	1.66	48.0	1.68	51.3	1.70	52.9	1.71
	32	37.6	1.69	42.5	1.72	44.8	1.74	48.0	1.76	51.3	1.78	52.9	1.79
	41	37.6	1.89	42.5	1.92	44.8	1.94	48.0	1.96	51.3	1.98	52.9	1.99
	50	37.6	2.08	42.5	2.12	44.8	2.13	48.0	2.16	51.3	2.18	52.9	2.19
	59	37.6	2.86	42.5	2.91	44.8	2.94	48.0	2.97	51.3	3.00	52.9	3.02
	67	37.6	3.65	42.5	3.71	44.8	3.74	48.0	3.78	51.3	3.82	52.9	3.85
	77	37.6	4.02	42.5	4.09	44.8	4.12	48.0	4.17	51.3	4.21	52.9	4.24
	87	37.6	4.39	42.5	4.46	44.8	4.50	48.0	4.55	51.3	4.60	52.9	4.63
	95	37.6	4.68	42.5	4.77	44.8	4.81	48.0	4.86	51.3	4.92	52.9	4.94
	104	32.7	4.35	37.0	4.43	39.0	4.46	41.8	4.51	44.6	4.56	46.0	4.59
115	27.8	4.01	31.5	4.08	33.2	4.12	35.5	4.16	38.0	4.21	39.1	4.23	
53	14	37.6	1.55	42.5	1.58	44.8	1.59	48.0	1.61	51.3	1.63	52.9	1.64
	23	37.6	1.62	42.5	1.65	44.8	1.66	48.0	1.68	51.3	1.70	52.9	1.71
	32	37.6	1.69	42.5	1.72	44.8	1.74	48.0	1.76	51.3	1.78	52.9	1.79
	41	37.6	1.89	42.5	1.92	44.8	1.94	48.0	1.96	51.3	1.98	52.9	1.99
	50	37.6	2.08	42.5	2.12	44.8	2.13	48.0	2.16	51.3	2.18	52.9	2.19
	59	37.6	2.86	42.5	2.91	44.8	2.94	48.0	2.97	51.3	3.00	52.9	3.02
	67	37.6	3.65	42.5	3.71	44.8	3.74	48.0	3.78	51.3	3.82	52.9	3.85
	77	37.6	4.02	42.5	4.09	44.8	4.12	48.0	4.17	51.3	4.21	52.9	4.24
	87	37.6	4.39	42.5	4.46	44.8	4.50	48.0	4.55	51.3	4.60	52.9	4.63
	95	37.6	4.68	42.5	4.77	44.8	4.81	48.0	4.86	51.3	4.92	52.9	4.94
	104	32.7	4.35	37.0	4.43	39.0	4.46	41.8	4.51	44.6	4.56	46.0	4.59
115	27.8	4.01	31.5	4.08	33.2	4.12	35.5	4.16	38.0	4.21	39.1	4.23	
52	14	37.6	1.55	42.5	1.58	44.8	1.59	48.0	1.61	51.3	1.63	52.9	1.64
	23	37.6	1.62	42.5	1.65	44.8	1.66	48.0	1.68	51.3	1.70	52.9	1.71
	32	37.6	1.69	42.5	1.72	44.8	1.74	48.0	1.76	51.3	1.78	52.9	1.79
	41	37.6	1.89	42.5	1.92	44.8	1.94	48.0	1.96	51.3	1.98	52.9	1.99
	50	37.6	2.08	42.5	2.12	44.8	2.13	48.0	2.16	51.3	2.18	52.9	2.19
	59	37.6	2.86	42.5	2.91	44.8	2.94	48.0	2.97	51.3	3.00	52.9	3.02
	67	37.6	3.65	42.5	3.71	44.8	3.74	48.0	3.78	51.3	3.82	52.9	3.85
	77	37.6	4.02	42.5	4.09	44.8	4.12	48.0	4.17	51.3	4.21	52.9	4.24
	87	37.6	4.39	42.5	4.46	44.8	4.50	48.0	4.55	51.3	4.60	52.9	4.63
	95	37.6	4.68	42.5	4.77	44.8	4.81	48.0	4.86	51.3	4.92	52.9	4.94
	104	32.7	4.35	37.0	4.43	39.0	4.46	41.8	4.51	44.6	4.56	46.0	4.59
115	27.8	4.01	31.5	4.08	33.2	4.12	35.5	4.16	38.0	4.21	39.1	4.23	
51	14	37.6	1.55	42.5	1.58	44.8	1.59	48.0	1.61	51.3	1.63	52.9	1.64
	23	37.6	1.62	42.5	1.65	44.8	1.66	48.0	1.68	51.3	1.70	52.9	1.71
	32	37.6	1.69	42.5	1.72	44.8	1.74	48.0	1.76	51.3	1.78	52.9	1.79
	41	37.6	1.89	42.5	1.92	44.8	1.94	48.0	1.96	51.3	1.98	52.9	1.99
	50	37.6	2.08	42.5	2.12	44.8	2.13	48.0	2.16	51.3	2.18	52.9	2.19
	59	37.6	2.86	42.5	2.91	44.8	2.94	48.0	2.97	51.3	3.00	52.9	3.02
	67	37.6	3.65	42.5	3.71	44.8	3.74	48.0	3.78	51.3	3.82	52.9	3.85
	77	37.6	4.02	42.5	4.09	44.8	4.12	48.0	4.17	51.3	4.21	52.9	4.24
	87	37.6	4.39	42.5	4.46	44.8	4.50	48.0	4.55	51.3	4.60	52.9	4.63
	95	37.6	4.68	42.5	4.77	44.8	4.81	48.0	4.86	51.3	4.92	52.9	4.94
	104	32.7	4.35	37.0	4.43	39.0	4.46	41.8	4.51	44.6	4.56	46.0	4.59
115	27.8	4.01	31.5	4.08	33.2	4.12	35.5	4.16	38.0	4.21	39.1	4.23	
50	14	37.6	1.55	42.5	1.58	44.8	1.59	48.0	1.61	51.3	1.63	52.9	1.64
	23	37.6	1.62	42.5	1.65	44.8	1.66	48.0	1.68	51.3	1.70	52.9	1.71
	32	37.6	1.69	42.5	1.72	44.8	1.74	48.0	1.76	51.3	1.78	52.9	1.79
	41	37.6	1.89	42.5	1.92	44.8	1.94	48.0	1.96	51.3	1.98	52.9	1.99
	50	37.6	2.08	42.5	2.12	44.8	2.13	48.0	2.16	51.3	2.18	52.9	2.19
	59	37.6	2.86	42.5	2.91	44.8	2.94	48.0	2.97	51.3	3.00	52.9	3.02
	67	37.6	3.65	42.5	3.71	44.8	3.74	48.0	3.78	51.3	3.82	52.9	3.85
	77	37.6	4.02	42.5	4.09	44.8	4.12	48.0	4.17	51.3	4.21	52.9	4.24
	87	37.6	4.39	42.5	4.46	44.8	4.50	48.0	4.55	51.3	4.60	52.9	4.63
	95	37.6	4.68	42.5	4.77	44.8	4.81	48.0	4.86	51.3	4.92	52.9	4.94
	104	32.7	4.35	37.0	4.43	39.0	4.46	41.8	4.51	44.6	4.56	46.0	4.59
115	27.8	4.01	31.5	4.08	33.2	4.12	35.5	4.16	38.0	4.21	39.1	4.23	
49	14	37.6	1.55	42.5	1.58	44.8	1.59	48.0	1.61	51.3	1.63	52.9	1.64
	23	37.6	1.62	42.5	1.65	44.8	1.66	48.0	1.68	51.3	1.70	52.9	1.71
	32	37.6	1.69	42.5	1.72	44.8	1.74	48.0	1.76	51.3	1.78	52.9	1.79
	41	37.6	1.89	42.5	1.92	44.8	1.94	48.0	1.96	51.3	1.98	52.9	1.99
	50	37.6	2.08	42.5	2.12	44.8	2.13	48.0	2.16	51.3	2.18	52.9	2.19
	59	37.6	2.86	42.5	2.91	44.8	2.94	48.0	2.97	51.3	3.00	52.9	3.02
	67	37.6	3.65	42.5	3.71	44.8	3.74	48.0	3.78	51.3	3.82	52.9	3.85
	77	37.6	4.02	42.5	4.09	44.8	4.12	48.0	4.17	51.3	4.21	52.9	4.24
	87	37.6	4.39	42.5	4.46	44.8	4.50	48.0	4.55	51.3	4.60	52.9	4.63
	95	37.6	4.68	42.5	4.77	44.8	4.81	48.0	4.86	51.3	4.92	52.9	4.94
	104	32.7	4.35	37.0	4.43	39.0	4.46	41.8	4.51	44.6	4.56	46.0	4.59
115	27.8	4.01	31.5	4.08	33.2	4.12	35.5	4.16	38.0	4.21	39.1	4.23	

OUTDOOR UNIT ROMH45AFXZJ

Indoor unit connecting capacity	Outdoor temperature	Indoor temperature											
		64 °FDB		70 °FDB		75 °FDB		80 °FDB		85 °FDB		90 °FDB	
		54 °FWB		60 °FWB		63 °FWB		67 °FWB		71 °FWB		73 °FWB	
kBtu/h	°FDB	TC	IP	TC	IP	TC	IP	TC	IP	TC	IP	TC	IP
48	14	37.6	1.55	42.5	1.58	44.8	1.59	48.0	1.61	51.3	1.63	52.9	1.64
	23	37.6	1.62	42.5	1.65	44.8	1.66	48.0	1.68	51.3	1.70	52.9	1.71
	32	37.6	1.69	42.5	1.72	44.8	1.74	48.0	1.76	51.3	1.78	52.9	1.79
	41	37.6	1.89	42.5	1.92	44.8	1.94	48.0	1.96	51.3	1.98	52.9	1.99
	50	37.6	2.08	42.5	2.12	44.8	2.13	48.0	2.16	51.3	2.18	52.9	2.19
	59	37.6	2.86	42.5	2.91	44.8	2.94	48.0	2.97	51.3	3.00	52.9	3.02
	67	37.6	3.65	42.5	3.71	44.8	3.74	48.0	3.78	51.3	3.82	52.9	3.85
	77	37.6	4.02	42.5	4.09	44.8	4.12	48.0	4.17	51.3	4.21	52.9	4.24
	87	37.6	4.39	42.5	4.46	44.8	4.50	48.0	4.55	51.3	4.60	52.9	4.63
	95	37.6	4.68	42.5	4.77	44.8	4.81	48.0	4.86	51.3	4.92	52.9	4.94
	104	32.7	4.35	37.0	4.43	39.0	4.46	41.8	4.51	44.6	4.56	46.0	4.59
115	27.8	4.01	31.5	4.08	33.2	4.12	35.5	4.16	38.0	4.21	39.1	4.23	
47	14	37.6	1.55	42.5	1.58	44.8	1.59	48.0	1.61	51.3	1.63	52.9	1.64
	23	37.6	1.62	42.5	1.65	44.8	1.66	48.0	1.68	51.3	1.70	52.9	1.71
	32	37.6	1.69	42.5	1.72	44.8	1.74	48.0	1.76	51.3	1.78	52.9	1.79
	41	37.6	1.89	42.5	1.92	44.8	1.94	48.0	1.96	51.3	1.98	52.9	1.99
	50	37.6	2.08	42.5	2.12	44.8	2.13	48.0	2.16	51.3	2.18	52.9	2.19
	59	37.6	2.86	42.5	2.91	44.8	2.94	48.0	2.97	51.3	3.00	52.9	3.02
	67	37.6	3.65	42.5	3.71	44.8	3.74	48.0	3.78	51.3	3.82	52.9	3.85
	77	37.6	4.02	42.5	4.09	44.8	4.12	48.0	4.17	51.3	4.21	52.9	4.24
	87	37.6	4.39	42.5	4.46	44.8	4.50	48.0	4.55	51.3	4.60	52.9	4.63
	95	37.6	4.68	42.5	4.77	44.8	4.81	48.0	4.86	51.3	4.92	52.9	4.94
	104	32.7	4.35	37.0	4.43	39.0	4.46	41.8	4.51	44.6	4.56	46.0	4.59
115	27.8	4.01	31.5	4.08	33.2	4.12	35.5	4.16	38.0	4.21	39.1	4.23	
46	14	37.6	1.55	42.5	1.58	44.8	1.59	48.0	1.61	51.3	1.63	52.9	1.64
	23	37.6	1.62	42.5	1.65	44.8	1.66	48.0	1.68	51.3	1.70	52.9	1.71
	32	37.6	1.69	42.5	1.72	44.8	1.74	48.0	1.76	51.3	1.78	52.9	1.79
	41	37.6	1.89	42.5	1.92	44.8	1.94	48.0	1.96	51.3	1.98	52.9	1.99
	50	37.6	2.08	42.5	2.12	44.8	2.13	48.0	2.16	51.3	2.18	52.9	2.19
	59	37.6	2.86	42.5	2.91	44.8	2.94	48.0	2.97	51.3	3.00	52.9	3.02
	67	37.6	3.65	42.5	3.71	44.8	3.74	48.0	3.78	51.3	3.82	52.9	3.85
	77	37.6	4.02	42.5	4.09	44.8	4.12	48.0	4.17	51.3	4.21	52.9	4.24
	87	37.6	4.39	42.5	4.46	44.8	4.50	48.0	4.55	51.3	4.60	52.9	4.63
	95	37.6	4.68	42.5	4.77	44.8	4.81	48.0	4.86	51.3	4.92	52.9	4.94
	104	32.7	4.35	37.0	4.43	39.0	4.46	41.8	4.51	44.6	4.56	46.0	4.59
115	27.8	4.01	31.5	4.08	33.2	4.12	35.5	4.16	38.0	4.21	39.1	4.23	
45	14	37.6	1.55	42.5	1.58	44.8	1.59	48.0	1.61	51.3	1.63	52.9	1.64
	23	37.6	1.62	42.5	1.65	44.8	1.66	48.0	1.68	51.3	1.70	52.9	1.71
	32	37.6	1.69	42.5	1.72	44.8	1.74	48.0	1.76	51.3	1.78	52.9	1.79
	41	37.6	1.89	42.5	1.92	44.8	1.94	48.0	1.96	51.3	1.98	52.9	1.99
	50	37.6	2.08	42.5	2.12	44.8	2.13	48.0	2.16	51.3	2.18	52.9	2.19
	59	37.6	2.86	42.5	2.91	44.8	2.94	48.0	2.97	51.3	3.00	52.9	3.02
	67	37.6	3.65	42.5	3.71	44.8	3.74	48.0	3.78	51.3	3.82	52.9	3.85
	77	37.6	4.02	42.5	4.09	44.8	4.12	48.0	4.17	51.3	4.21	52.9	4.24
	87	37.6	4.39	42.5	4.46	44.8	4.50	48.0	4.55	51.3	4.60	52.9	4.63
	95	37.6	4.68	42.5	4.77	44.8	4.81	48.0	4.86	51.3	4.92	52.9	4.94
	104	32.7	4.35	37.0	4.43	39.0	4.46	41.8	4.51	44.6	4.56	46.0	4.59
115	27.8	4.01	31.5	4.08	33.2	4.12	35.5	4.16	38.0	4.21	39.1	4.23	
44	14	36.8	1.52	41.6	1.55	43.8	1.56	46.9	1.58	50.2	1.60	51.7	1.60
	23	36.8	1.59	41.6	1.62	43.8	1.63	46.9	1.65	50.2	1.67	51.7	1.68
	32	36.8	1.66	41.6	1.69	43.8	1.70	46.9	1.72	50.2	1.74	51.7	1.75
	41	36.8	1.85	41.6	1.88	43.8	1.90	46.9	1.92	50.2	1.94	51.7	1.95
	50	36.8	2.04	41.6	2.07	43.8	2.09	46.9	2.11	50.2	2.14	51.7	2.15
	59	36.8	2.81	41.6	2.85	43.8	2.88	46.9	2.91	50.2	2.94	51.7	2.96
	67	36.8	3.57	41.6	3.64	43.8	3.67	46.9	3.71	50.2	3.75	51.7	3.77
	77	36.8	3.94	41.6	4.01	43.8	4.04	46.9	4.08	50.2	4.13	51.7	4.15
	87	36.8	4.30	41.6	4.38	43.8	4.41	46.9	4.46	50.2	4.51	51.7	4.54
	95	36.8	4.59	41.6	4.67	43.8	4.71	46.9	4.76	50.2	4.82	51.7	4.84
	104	32.0	4.26	36.2	4.34	38.1	4.37	40.8	4.42	43.6	4.47	45.0	4.50
115	32.0	3.93	36.2	4.00	38.1	4.04	40.8	4.08	43.6	4.13	45.0	4.15	
43	14	36.0	1.47	40.6	1.49	42.8	1.51	45.9	1.52	49.0	1.54	50.5	1.55
	23	36.0	1.54	40.6	1.56	42.8	1.58	45.9	1.59	49.0	1.61	50.5	1.62
	32	36.0	1.60	40.6	1.63	42.8	1.64	45.9	1.66	49.0	1.68	50.5	1.69
	41	36.0	1.79	40.6	1.82	42.8	1.83	45.9	1.85	49.0	1.87	50.5	1.88
	50	36.0	1.97	40.6	2.00	42.8	2.02	45.9	2.04	49.0	2.07	50.5	2.08
	59	36.0	2.71	40.6	2.76	42.8	2.78	45.9	2.81	49.0	2.84	50.5	2.86
	67	36.0	3.45	40.6	3.51	42.8	3.54	45.9	3.58	49.0	3.62	50.5	3.64
	77	36.0	3.80	40.6	3.87	42.8	3.90	45.9	3.95	49.0	3.99	50.5	4.01
	87	36.0	4.15	40.6	4.23	42.8	4.26	45.9	4.31	49.0	4.36	50.5	4.38
	95	36.0	4.44	40.6	4.51	42.8	4.55	45.9	4.60	49.0	4.65	50.5	4.68
	104	31.3	4.12	35.3	4.19	37.3	4.23	39.9	4.27	42.7	4.32	44.0	4.34
115	31.3	3.80	35.3	3.87	37.3	3.90	39.9	3.94	42.7	3.99	44.0	4.01	
42	14	35.1	1.42	39.7	1.44	41.8	1.45	44.8	1.47	47.9	1.49	49.4	1.50
	23	35.1	1.48	39.7	1.51	41.8	1.52	44.8	1.54	47.9	1.56	49.4	1.56
	32	35.1	1.55	39.7	1.57	41.8	1.59	44.8	1.60	47.9	1.62	49.4	1.63
	41	35.1	1.72	39.7	1.75	41.8	1.77	44.8	1.79	47.9	1.81	49.4	1.82
	50	35.1	1.90	39.7	1.93	41.8	1.95	44.8	1.97	47.9	1.99	49.4	2.01
	59	35.1	2.62	39.7	2.66	41.8	2.68	44.8	2.71	47.9	2.74	49.4	2.76
	67	35.1	3.33	39.7	3.39	41.8	3.42	44.8	3.46	47.9	3.50	49.4	3.51
	77	35.1	3.67	39.7	3.74	41.8	3.77	44.8	3.81	47.9	3.85	49.4	3.87
	87	35.1	4.01	39.7	4.08	41.8	4.11	44.8	4.16	47.9	4.21	49.4	4.23
	95	35.1	4.28	39.7	4.36	41.8	4.39	44.8	4.44	47.9	4.49	49.4	4.52
	104	30.6	3.97	34.5	4.04	36.4	4.08	39.0	4.12	41.7	4.17	42.9	4.19
115	30.6	3.67	34.5	3.73	36.4	3.76	39.0	3.80	41.7	3.85	42.9	3.87	

Indoor unit connecting capacity	Outdoor temperature	Indoor temperature											
		64 °FDB		70 °FDB		75 °FDB		80 °FDB		85 °FDB		90 °FDB	
		54 °FWB		60 °FWB		63 °FWB		67 °FWB		71 °FWB		73 °FWB	
kBtu/h	°FDB	TC	IP	TC	IP	TC	IP	TC	IP	TC	IP	TC	IP
41	14	34.3	1.37	38.7	1.39	40.8	1.40	43.7	1.42	46.8	1.43	48.2	1.44
	23	34.3	1.43	38.7	1.45	40.8	1.47	43.7	1.48	46.8	1.50	48.2	1.51
	32	34.3	1.49	38.7	1.52	40.8	1.53	43.7	1.55	46.8	1.56	48.2	1.57
	41	34.3	1.66	38.7	1.69	40.8	1.70	43.7	1.72	46.8	1.74	48.2	1.75
	50	34.3	1.83	38.7	1.86	40.8	1.88	43.7	1.90	46.8	1.92	48.2	1.93
	59	34.3	2.52	38.7	2.57	40.8	2.59	43.7	2.62	46.8	2.65	48.2	2.66
	67	34.3	3.21	38.7	3.27	40.8	3.29	43.7	3.33	46.8	3.37	48.2	3.39
	77	34.3	3.54	38.7	3.60	40.8	3.63	43.7	3.67	46.8	3.71	48.2	3.73
	87	34.3	3.86	38.7	3.93	40.8	3.96	43.7	4.01	46.8	4.05	48.2	4.08
	95	34.3	4.13	38.7	4.20	40.8	4.23	43.7	4.28	46.8	4.33	48.2	4.35
104	29.8	3.83	33.7	3.90	35.5	3.93	38.0	3.97	40.7	4.02	41.9	4.04	
115	29.8	3.54	33.7	3.60	35.5	3.63	38.0	3.67	40.7	3.71	41.9	3.73	
40	14	33.5	1.32	37.8	1.34	39.9	1.35	42.7	1.36	45.6	1.38	47.0	1.39
	23	33.5	1.38	37.8	1.40	39.9	1.41	42.7	1.43	45.6	1.44	47.0	1.45
	32	33.5	1.44	37.8	1.46	39.9	1.47	42.7	1.49	45.6	1.51	47.0	1.51
	41	33.5	1.60	37.8	1.63	39.9	1.64	42.7	1.66	45.6	1.68	47.0	1.69
	50	33.5	1.76	37.8	1.79	39.9	1.81	42.7	1.83	45.6	1.85	47.0	1.86
	59	33.5	2.43	37.8	2.47	39.9	2.49	42.7	2.52	45.6	2.55	47.0	2.56
	67	33.5	3.09	37.8	3.14	39.9	3.17	42.7	3.21	45.6	3.24	47.0	3.26
	77	33.5	3.40	37.8	3.46	39.9	3.49	42.7	3.53	45.6	3.57	47.0	3.59
	87	33.5	3.72	37.8	3.78	39.9	3.82	42.7	3.86	45.6	3.90	47.0	3.92
	95	33.5	3.97	37.8	4.04	39.9	4.07	42.7	4.12	45.6	4.17	47.0	4.19
104	29.1	3.69	32.9	3.75	34.7	3.78	37.1	3.82	39.7	3.87	40.9	3.89	
115	29.1	3.40	32.9	3.46	34.7	3.49	37.1	3.53	39.7	3.57	40.9	3.59	
39	14	32.6	1.26	36.9	1.29	38.9	1.30	41.6	1.31	44.5	1.33	45.8	1.33
	23	32.6	1.32	36.9	1.34	38.9	1.36	41.6	1.37	44.5	1.39	45.8	1.39
	32	32.6	1.38	36.9	1.40	38.9	1.41	41.6	1.43	44.5	1.45	45.8	1.45
	41	32.6	1.54	36.9	1.56	38.9	1.58	41.6	1.59	44.5	1.61	45.8	1.62
	50	32.6	1.69	36.9	1.72	38.9	1.74	41.6	1.76	44.5	1.78	45.8	1.79
	59	32.6	2.33	36.9	2.37	38.9	2.39	41.6	2.42	44.5	2.45	45.8	2.46
	67	32.6	2.97	36.9	3.02	38.9	3.05	41.6	3.08	44.5	3.12	45.8	3.13
	77	32.6	3.27	36.9	3.33	38.9	3.36	41.6	3.39	44.5	3.43	45.8	3.45
	87	32.6	3.57	36.9	3.64	38.9	3.67	41.6	3.71	44.5	3.75	45.8	3.77
	95	32.6	3.82	36.9	3.88	38.9	3.91	41.6	3.96	44.5	4.00	45.8	4.03
104	28.4	3.54	32.1	3.61	33.8	3.63	36.2	3.67	38.7	3.72	39.9	3.74	
115	28.4	3.27	32.1	3.33	33.8	3.35	36.2	3.39	38.7	3.43	39.9	3.45	
38	14	31.8	1.21	35.9	1.23	37.9	1.24	40.5	1.26	43.3	1.27	44.7	1.28
	23	31.8	1.27	35.9	1.29	37.9	1.30	40.5	1.32	43.3	1.33	44.7	1.34
	32	31.8	1.32	35.9	1.35	37.9	1.36	40.5	1.37	43.3	1.39	44.7	1.40
	41	31.8	1.47	35.9	1.50	37.9	1.51	40.5	1.53	43.3	1.55	44.7	1.56
	50	31.8	1.63	35.9	1.65	37.9	1.67	40.5	1.69	43.3	1.71	44.7	1.71
	59	31.8	2.24	35.9	2.28	37.9	2.30	40.5	2.32	43.3	2.35	44.7	2.36
	67	31.8	2.85	35.9	2.90	37.9	2.92	40.5	2.96	43.3	2.99	44.7	3.01
	77	31.8	3.14	35.9	3.19	37.9	3.22	40.5	3.26	43.3	3.29	44.7	3.31
	87	31.8	3.43	35.9	3.49	37.9	3.52	40.5	3.56	43.3	3.60	44.7	3.62
	95	31.8	3.66	35.9	3.73	37.9	3.76	40.5	3.80	43.3	3.84	44.7	3.86
104	27.6	3.40	31.2	3.46	32.9	3.49	35.3	3.53	37.7	3.57	38.9	3.59	
115	27.6	3.14	31.2	3.19	32.9	3.22	35.3	3.25	37.7	3.29	38.9	3.31	
37	14	30.9	1.16	35.0	1.18	36.9	1.19	39.5	1.20	42.2	1.22	43.5	1.22
	23	30.9	1.21	35.0	1.24	36.9	1.25	39.5	1.26	42.2	1.27	43.5	1.28
	32	30.9	1.27	35.0	1.29	36.9	1.30	39.5	1.31	42.2	1.33	43.5	1.34
	41	30.9	1.41	35.0	1.44	36.9	1.45	39.5	1.46	42.2	1.48	43.5	1.49
	50	30.9	1.56	35.0	1.58	36.9	1.60	39.5	1.61	42.2	1.63	43.5	1.64
	59	30.9	2.14	35.0	2.18	36.9	2.20	39.5	2.22	42.2	2.25	43.5	2.26
	67	30.9	2.73	35.0	2.78	36.9	2.80	39.5	2.83	42.2	2.86	43.5	2.88
	77	30.9	3.01	35.0	3.06	36.9	3.08	39.5	3.12	42.2	3.15	43.5	3.17
	87	30.9	3.28	35.0	3.34	36.9	3.37	39.5	3.41	42.2	3.45	43.5	3.46
	95	30.9	3.51	35.0	3.57	36.9	3.60	39.5	3.64	42.2	3.68	43.5	3.70
104	26.9	3.25	30.4	3.31	32.1	3.34	34.3	3.38	36.7	3.42	37.8	3.43	
115	26.9	3.00	30.4	3.06	32.1	3.08	34.3	3.12	36.7	3.15	37.8	3.17	
36	14	30.1	1.11	34.0	1.13	35.9	1.14	38.4	1.15	41.0	1.16	42.3	1.17
	23	30.1	1.16	34.0	1.18	35.9	1.19	38.4	1.20	41.0	1.22	42.3	1.22
	32	30.1	1.21	34.0	1.23	35.9	1.24	38.4	1.26	41.0	1.27	42.3	1.28
	41	30.1	1.35	34.0	1.37	35.9	1.38	38.4	1.40	41.0	1.42	42.3	1.42
	50	30.1	1.49	34.0	1.51	35.9	1.53	38.4	1.54	41.0	1.56	42.3	1.57
	59	30.1	2.05	34.0	2.08	35.9	2.10	38.4	2.12	41.0	2.15	42.3	2.16
	67	30.1	2.61	34.0	2.65	35.9	2.68	38.4	2.70	41.0	2.74	42.3	2.75
	77	30.1	2.87	34.0	2.92	35.9	2.95	38.4	2.98	41.0	3.01	42.3	3.03
	87	30.1	3.14	34.0	3.19	35.9	3.22	38.4	3.26	41.0	3.29	42.3	3.31
	95	30.1	3.35	34.0	3.41	35.9	3.44	38.4	3.48	41.0	3.52	42.3	3.54
104	26.2	3.11	29.6	3.17	31.2	3.19	33.4	3.23	35.7	3.26	36.8	3.28	
115	26.2	2.87	29.6	2.92	31.2	2.95	33.4	2.98	35.7	3.01	36.8	3.03	
35	14	29.3	1.06	33.1	1.08	34.9	1.09	37.3	1.10	39.9	1.11	41.1	1.12
	23	29.3	1.11	33.1	1.13	34.9	1.14	37.3	1.15	39.9	1.16	41.1	1.17
	32	29.3	1.15	33.1	1.18	34.9	1.18	37.3	1.20	39.9	1.21	41.1	1.22
	41	29.3	1.29	33.1	1.31	34.9	1.32	37.3	1.34	39.9	1.35	41.1	1.36
	50	29.3	1.42	33.1	1.44	34.9	1.46	37.3	1.47	39.9	1.49	41.1	1.50
	59	29.3	1.95	33.1	1.99	34.9	2.00	37.3	2.03	39.9	2.05	41.1	2.06
	67	29.3	2.49	33.1	2.53	34.9	2.55	37.3	2.58	39.9	2.61	41.1	2.62
	77	29.3	2.74	33.1	2.79	34.9	2.81	37.3	2.84	39.9	2.88	41.1	2.89
	87	29.3	2.99	33.1	3.05	34.9	3.07	37.3	3.11	39.9	3.14	41.1	3.16
	95	29.3	3.20	33.1	3.25	34.9	3.28	37.3	3.32	39.9	3.35	41.1	3.37
104	25.5	2.97	28.8	3.02	30.3	3.04	32.5	3.08	34.7	3.11	35.8	3.13	
115	25.5	2.74	28.8	2.79	30.3	2.81	32.5	2.84	34.7	2.87	35.8	2.89	

OUTDOOR UNIT  
ROMH45AFZJ

Indoor unit connecting capacity	Outdoor temperature	Indoor temperature											
		64 °FDB		70 °FDB		75 °FDB		80 °FDB		85 °FDB		90 °FDB	
		54 °FWB		60 °FWB		63 °FWB		67 °FWB		71 °FWB		73 °FWB	
kBtu/h	°FDB	TC	IP	TC	IP	TC	IP	TC	IP	TC	IP	TC	IP
34	14	28.4	1.01	32.1	1.02	33.9	1.03	36.3	1.04	38.8	1.06	40.0	1.06
	23	28.4	1.05	32.1	1.07	33.9	1.08	36.3	1.09	38.8	1.10	40.0	1.11
	32	28.4	1.10	32.1	1.12	33.9	1.13	36.3	1.14	38.8	1.15	40.0	1.16
	41	28.4	1.22	32.1	1.25	33.9	1.26	36.3	1.27	38.8	1.28	40.0	1.29
	50	28.4	1.35	32.1	1.37	33.9	1.39	36.3	1.40	38.8	1.42	40.0	1.42
	59	28.4	1.86	32.1	1.89	33.9	1.91	36.3	1.93	38.8	1.95	40.0	1.96
	67	28.4	2.37	32.1	2.41	33.9	2.43	36.3	2.45	38.8	2.48	40.0	2.50
	77	28.4	2.61	32.1	2.65	33.9	2.67	36.3	2.70	38.8	2.74	40.0	2.75
	87	28.4	2.85	32.1	2.90	33.9	2.92	36.3	2.95	38.8	2.99	40.0	3.00
	95	28.4	3.04	32.1	3.09	33.9	3.12	36.3	3.15	38.8	3.19	40.0	3.21
	104	24.7	2.82	28.0	2.87	29.5	2.90	31.5	2.93	33.7	2.96	34.8	2.98
	115	24.7	2.61	28.0	2.65	29.5	2.67	31.5	2.70	33.7	2.73	34.8	2.75

**NOTE:** Specifications are based on the following conditions.

- Power source of specifications: 230 V
- 2 or more indoor units should be connected.
- Pipe length: 24.6 ft (7.5 m), Height difference: 0 ft (0 m) [Outdoor unit - Indoor unit]
- The total ability of connected a indoor unit is from 34,000 Btu up to 54,000 Btu.
- Input in the table are calculated based on the maximum indoor unit input combinations.



Indoor unit connecting capacity	Outdoor temperature	Indoor temperature											
		17.8 °CDB		21.1 °CDB		23.9 °CDB		26.7 °CDB		29.4 °CDB		32.2 °CDB	
		12.2 °CWB		15.6 °CWB		17.2 °CWB		19.4 °CWB		21.7 °CWB		22.8 °CWB	
kBtu/h	°CDB	TC	IP	TC	IP	TC	IP	TC	IP	TC	IP	TC	IP
48	-10.0	11.02	1.55	12.46	1.58	13.13	1.59	14.00	1.61	15.03	1.63	15.50	1.64
	-5.0	11.02	1.62	12.46	1.65	13.13	1.66	14.00	1.68	15.03	1.70	15.50	1.71
	0.0	11.02	1.69	12.46	1.72	13.13	1.74	14.00	1.76	15.03	1.78	15.50	1.79
	5.0	11.02	1.89	12.46	1.92	13.13	1.94	14.00	1.96	15.03	1.98	15.50	1.99
	10.0	11.02	2.08	12.46	2.12	13.13	2.13	14.00	2.16	15.03	2.18	15.50	2.19
	15.0	11.02	2.86	12.46	2.91	13.13	2.94	14.00	2.97	15.03	3.00	15.50	3.02
	20.0	11.02	3.65	12.46	3.71	13.13	3.74	14.00	3.78	15.03	3.82	15.50	3.85
	25.0	11.02	4.02	12.46	4.09	13.13	4.12	14.00	4.17	15.03	4.21	15.50	4.24
	30.0	11.02	4.39	12.46	4.46	13.13	4.50	14.00	4.55	15.03	4.60	15.50	4.63
	35.0	11.02	4.68	12.46	4.77	13.13	4.81	14.00	4.86	15.03	4.92	15.50	4.94
	40.0	9.59	4.35	10.84	4.43	11.42	4.46	12.20	4.51	13.08	4.56	13.48	4.59
46.1	8.15	4.01	9.22	4.08	9.71	4.12	10.40	4.16	11.12	4.21	11.46	4.23	
47	-10.0	11.02	1.55	12.46	1.58	13.13	1.59	14.00	1.61	15.03	1.63	15.50	1.64
	-5.0	11.02	1.62	12.46	1.65	13.13	1.66	14.00	1.68	15.03	1.70	15.50	1.71
	0.0	11.02	1.69	12.46	1.72	13.13	1.74	14.00	1.76	15.03	1.78	15.50	1.79
	5.0	11.02	1.89	12.46	1.92	13.13	1.94	14.00	1.96	15.03	1.98	15.50	1.99
	10.0	11.02	2.08	12.46	2.12	13.13	2.13	14.00	2.16	15.03	2.18	15.50	2.19
	15.0	11.02	2.86	12.46	2.91	13.13	2.94	14.00	2.97	15.03	3.00	15.50	3.02
	20.0	11.02	3.65	12.46	3.71	13.13	3.74	14.00	3.78	15.03	3.82	15.50	3.85
	25.0	11.02	4.02	12.46	4.09	13.13	4.12	14.00	4.17	15.03	4.21	15.50	4.24
	30.0	11.02	4.39	12.46	4.46	13.13	4.50	14.00	4.55	15.03	4.60	15.50	4.63
	35.0	11.02	4.68	12.46	4.77	13.13	4.81	14.00	4.86	15.03	4.92	15.50	4.94
	40.0	9.59	4.35	10.84	4.43	11.42	4.46	12.20	4.51	13.08	4.56	13.48	4.59
46.1	8.15	4.01	9.22	4.08	9.71	4.12	10.40	4.16	11.12	4.21	11.46	4.23	
46	-10.0	11.02	1.55	12.46	1.58	13.13	1.59	14.00	1.61	15.03	1.63	15.50	1.64
	-5.0	11.02	1.62	12.46	1.65	13.13	1.66	14.00	1.68	15.03	1.70	15.50	1.71
	0.0	11.02	1.69	12.46	1.72	13.13	1.74	14.00	1.76	15.03	1.78	15.50	1.79
	5.0	11.02	1.89	12.46	1.92	13.13	1.94	14.00	1.96	15.03	1.98	15.50	1.99
	10.0	11.02	2.08	12.46	2.12	13.13	2.13	14.00	2.16	15.03	2.18	15.50	2.19
	15.0	11.02	2.86	12.46	2.91	13.13	2.94	14.00	2.97	15.03	3.00	15.50	3.02
	20.0	11.02	3.65	12.46	3.71	13.13	3.74	14.00	3.78	15.03	3.82	15.50	3.85
	25.0	11.02	4.02	12.46	4.09	13.13	4.12	14.00	4.17	15.03	4.21	15.50	4.24
	30.0	11.02	4.39	12.46	4.46	13.13	4.50	14.00	4.55	15.03	4.60	15.50	4.63
	35.0	11.02	4.68	12.46	4.77	13.13	4.81	14.00	4.86	15.03	4.92	15.50	4.94
	40.0	9.59	4.35	10.84	4.43	11.42	4.46	12.20	4.51	13.08	4.56	13.48	4.59
46.1	8.15	4.01	9.22	4.08	9.71	4.12	10.40	4.16	11.12	4.21	11.46	4.23	
45	-10.0	11.02	1.55	12.46	1.58	13.13	1.59	14.00	1.61	15.03	1.63	15.50	1.64
	-5.0	11.02	1.62	12.46	1.65	13.13	1.66	14.00	1.68	15.03	1.70	15.50	1.71
	0.0	11.02	1.69	12.46	1.72	13.13	1.74	14.00	1.76	15.03	1.78	15.50	1.79
	5.0	11.02	1.89	12.46	1.92	13.13	1.94	14.00	1.96	15.03	1.98	15.50	1.99
	10.0	11.02	2.08	12.46	2.12	13.13	2.13	14.00	2.16	15.03	2.18	15.50	2.19
	15.0	11.02	2.86	12.46	2.91	13.13	2.94	14.00	2.97	15.03	3.00	15.50	3.02
	20.0	11.02	3.65	12.46	3.71	13.13	3.74	14.00	3.78	15.03	3.82	15.50	3.85
	25.0	11.02	4.02	12.46	4.09	13.13	4.12	14.00	4.17	15.03	4.21	15.50	4.24
	30.0	11.02	4.39	12.46	4.46	13.13	4.50	14.00	4.55	15.03	4.60	15.50	4.63
	35.0	11.02	4.68	12.46	4.77	13.13	4.81	14.00	4.86	15.03	4.92	15.50	4.94
	40.0	9.59	4.35	10.84	4.43	11.42	4.46	12.20	4.51	13.08	4.56	13.48	4.59
46.1	8.15	4.01	9.22	4.08	9.71	4.12	10.40	4.16	11.12	4.21	11.46	4.23	
44	-10.0	10.78	1.52	12.18	1.55	12.84	1.56	13.70	1.58	14.70	1.60	15.15	1.60
	-5.0	10.78	1.59	12.18	1.62	12.84	1.63	13.70	1.65	14.70	1.67	15.15	1.68
	0.0	10.78	1.66	12.18	1.69	12.84	1.70	13.70	1.72	14.70	1.74	15.15	1.75
	5.0	10.78	1.85	12.18	1.88	12.84	1.90	13.70	1.92	14.70	1.94	15.15	1.95
	10.0	10.78	2.04	12.18	2.07	12.84	2.09	13.70	2.11	14.70	2.14	15.15	2.15
	15.0	10.78	2.81	12.18	2.85	12.84	2.88	13.70	2.91	14.70	2.94	15.15	2.96
	20.0	10.78	3.57	12.18	3.64	12.84	3.67	13.70	3.71	14.70	3.75	15.15	3.77
	25.0	10.78	3.94	12.18	4.01	12.84	4.04	13.70	4.08	14.70	4.13	15.15	4.15
	30.0	10.78	4.30	12.18	4.38	12.84	4.41	13.70	4.46	14.70	4.51	15.15	4.54
	35.0	10.78	4.59	12.18	4.67	12.84	4.71	13.70	4.76	14.70	4.82	15.15	4.84
	40.0	9.38	4.26	10.60	4.34	11.17	4.37	11.90	4.42	12.79	4.47	13.18	4.50
46.1	9.38	3.93	10.60	4.00	11.17	4.04	11.90	4.08	12.79	4.13	13.18	4.15	
43	-10.0	10.53	1.47	11.91	1.49	12.55	1.51	13.40	1.52	14.37	1.54	14.81	1.55
	-5.0	10.53	1.54	11.91	1.56	12.55	1.58	13.40	1.59	14.37	1.61	14.81	1.62
	0.0	10.53	1.60	11.91	1.63	12.55	1.64	13.40	1.66	14.37	1.68	14.81	1.69
	5.0	10.53	1.79	11.91	1.82	12.55	1.83	13.40	1.85	14.37	1.87	14.81	1.88
	10.0	10.53	1.97	11.91	2.00	12.55	2.02	13.40	2.04	14.37	2.07	14.81	2.08
	15.0	10.53	2.71	11.91	2.76	12.55	2.78	13.40	2.81	14.37	2.84	14.81	2.86
	20.0	10.53	3.45	11.91	3.51	12.55	3.54	13.40	3.58	14.37	3.62	14.81	3.64
	25.0	10.53	3.80	11.91	3.87	12.55	3.90	13.40	3.95	14.37	3.99	14.81	4.01
	30.0	10.53	4.15	11.91	4.23	12.55	4.26	13.40	4.31	14.37	4.36	14.81	4.38
	35.0	10.53	4.44	11.91	4.51	12.55	4.55	13.40	4.60	14.37	4.65	14.81	4.68
	40.0	9.16	4.12	10.36	4.19	10.92	4.23	11.60	4.27	12.50	4.32	12.88	4.34
46.1	9.16	3.80	10.36	3.87	10.92	3.90	11.60	3.94	12.50	3.99	12.88	4.01	
42	-10.0	10.29	1.42	11.63	1.44	12.26	1.45	13.10	1.47	14.03	1.49	14.46	1.50
	-5.0	10.29	1.48	11.63	1.51	12.26	1.52	13.10	1.54	14.03	1.56	14.46	1.56
	0.0	10.29	1.55	11.63	1.57	12.26	1.59	13.10	1.60	14.03	1.62	14.46	1.63
	5.0	10.29	1.72	11.63	1.75	12.26	1.77	13.10	1.79	14.03	1.81	14.46	1.82
	10.0	10.29	1.90	11.63	1.93	12.26	1.95	13.10	1.97	14.03	1.99	14.46	2.01
	15.0	10.29	2.62	11.63	2.66	12.26	2.68	13.10	2.71	14.03	2.74	14.46	2.76
	20.0	10.29	3.33	11.63	3.39	12.26	3.42	13.10	3.46	14.03	3.50	14.46	3.51
	25.0	10.29	3.67	11.63	3.74	12.26	3.77	13.10	3.81	14.03	3.85	14.46	3.87
	30.0	10.29	4.01	11.63	4.08	12.26	4.11	13.10	4.16	14.03	4.21	14.46	4.23
	35.0	10.29	4.28	11.63	4.36	12.26	4.39	13.10	4.44	14.03	4.49	14.46	4.52
	40.0	8.95	3.97	10.11	4.04	10.66	4.08	11.40	4.12	12.20	4.17	12.58	4.19
46.1	8.95	3.67	10.11	3.73	10.66	3.76	11.40	3.80	12.20	3.85	12.58	3.87	



Indoor unit connecting capacity	Outdoor temperature	Indoor temperature											
		17.8 °CDB		21.1 °CDB		23.9 °CDB		26.7 °CDB		29.4 °CDB		32.2 °CDB	
		12.2 °CWB		15.6 °CWB		17.2 °CWB		19.4 °CWB		21.7 °CWB		22.8 °CWB	
kBtu/h	°CDB	TC	IP	TC	IP	TC	IP	TC	IP	TC	IP	TC	IP
41	-10.0	10.04	1.37	11.35	1.39	11.97	1.40	12.80	1.42	13.70	1.43	14.12	1.44
	-5.0	10.04	1.43	11.35	1.45	11.97	1.47	12.80	1.48	13.70	1.50	14.12	1.51
	0.0	10.04	1.49	11.35	1.52	11.97	1.53	12.80	1.55	13.70	1.56	14.12	1.57
	5.0	10.04	1.66	11.35	1.69	11.97	1.70	12.80	1.72	13.70	1.74	14.12	1.75
	10.0	10.04	1.83	11.35	1.86	11.97	1.88	12.80	1.90	13.70	1.92	14.12	1.93
	15.0	10.04	2.52	11.35	2.57	11.97	2.59	12.80	2.62	13.70	2.65	14.12	2.66
	20.0	10.04	3.21	11.35	3.27	11.97	3.29	12.80	3.33	13.70	3.37	14.12	3.39
	25.0	10.04	3.54	11.35	3.60	11.97	3.63	12.80	3.67	13.70	3.71	14.12	3.73
	30.0	10.04	3.86	11.35	3.93	11.97	3.96	12.80	4.01	13.70	4.05	14.12	4.08
	35.0	10.04	4.13	11.35	4.20	11.97	4.23	12.80	4.28	13.70	4.33	14.12	4.35
	40.0	8.74	3.83	9.87	3.90	10.41	3.93	11.10	3.97	11.91	4.02	12.28	4.04
46.1	8.74	3.54	9.87	3.60	10.41	3.63	11.10	3.67	11.91	3.71	12.28	3.73	
40	-10.0	9.80	1.32	11.07	1.34	11.67	1.35	12.50	1.36	13.36	1.38	13.78	1.39
	-5.0	9.80	1.38	11.07	1.40	11.67	1.41	12.50	1.43	13.36	1.44	13.78	1.45
	0.0	9.80	1.44	11.07	1.46	11.67	1.47	12.50	1.49	13.36	1.51	13.78	1.51
	5.0	9.80	1.60	11.07	1.63	11.67	1.64	12.50	1.66	13.36	1.68	13.78	1.69
	10.0	9.80	1.76	11.07	1.79	11.67	1.81	12.50	1.83	13.36	1.85	13.78	1.86
	15.0	9.80	2.43	11.07	2.47	11.67	2.49	12.50	2.52	13.36	2.55	13.78	2.56
	20.0	9.80	3.09	11.07	3.14	11.67	3.17	12.50	3.21	13.36	3.24	13.78	3.26
	25.0	9.80	3.40	11.07	3.46	11.67	3.49	12.50	3.53	13.36	3.57	13.78	3.59
	30.0	9.80	3.72	11.07	3.78	11.67	3.82	12.50	3.86	13.36	3.90	13.78	3.92
	35.0	9.80	3.97	11.07	4.04	11.67	4.07	12.50	4.12	13.36	4.17	13.78	4.19
	40.0	8.52	3.69	9.63	3.75	10.15	3.78	10.80	3.82	11.62	3.87	11.98	3.89
46.1	8.52	3.40	9.63	3.46	10.15	3.49	10.80	3.53	11.62	3.57	11.98	3.59	
39	-10.0	9.55	1.26	10.80	1.29	11.38	1.30	12.10	1.31	13.03	1.33	13.43	1.33
	-5.0	9.55	1.32	10.80	1.34	11.38	1.36	12.10	1.37	13.03	1.39	13.43	1.39
	0.0	9.55	1.38	10.80	1.40	11.38	1.41	12.10	1.43	13.03	1.45	13.43	1.45
	5.0	9.55	1.54	10.80	1.56	11.38	1.58	12.10	1.59	13.03	1.61	13.43	1.62
	10.0	9.55	1.69	10.80	1.72	11.38	1.74	12.10	1.76	13.03	1.78	13.43	1.79
	15.0	9.55	2.33	10.80	2.37	11.38	2.39	12.10	2.42	13.03	2.45	13.43	2.46
	20.0	9.55	2.97	10.80	3.02	11.38	3.05	12.10	3.08	13.03	3.12	13.43	3.13
	25.0	9.55	3.27	10.80	3.33	11.38	3.36	12.10	3.39	13.03	3.43	13.43	3.45
	30.0	9.55	3.57	10.80	3.64	11.38	3.67	12.10	3.71	13.03	3.75	13.43	3.77
	35.0	9.55	3.82	10.80	3.88	11.38	3.91	12.10	3.96	13.03	4.00	13.43	4.03
	40.0	8.31	3.54	9.39	3.61	9.90	3.63	10.60	3.67	11.33	3.72	11.68	3.74
46.1	8.31	3.27	9.39	3.33	9.90	3.35	10.60	3.39	11.33	3.43	11.68	3.45	
38	-10.0	9.31	1.21	10.52	1.23	11.09	1.24	11.80	1.26	12.69	1.27	13.09	1.28
	-5.0	9.31	1.27	10.52	1.29	11.09	1.30	11.80	1.32	12.69	1.33	13.09	1.34
	0.0	9.31	1.32	10.52	1.35	11.09	1.36	11.80	1.37	12.69	1.39	13.09	1.40
	5.0	9.31	1.47	10.52	1.50	11.09	1.51	11.80	1.53	12.69	1.55	13.09	1.56
	10.0	9.31	1.63	10.52	1.65	11.09	1.67	11.80	1.69	12.69	1.71	13.09	1.71
	15.0	9.31	2.24	10.52	2.28	11.09	2.30	11.80	2.32	12.69	2.35	13.09	2.36
	20.0	9.31	2.85	10.52	2.90	11.09	2.92	11.80	2.96	12.69	2.99	13.09	3.01
	25.0	9.31	3.14	10.52	3.19	11.09	3.22	11.80	3.26	12.69	3.29	13.09	3.31
	30.0	9.31	3.43	10.52	3.49	11.09	3.52	11.80	3.56	12.69	3.60	13.09	3.62
	35.0	9.31	3.66	10.52	3.73	11.09	3.76	11.80	3.80	12.69	3.84	13.09	3.86
	40.0	8.10	3.40	9.15	3.46	9.65	3.49	10.30	3.53	11.04	3.57	11.38	3.59
46.1	8.10	3.14	9.15	3.19	9.65	3.22	10.30	3.25	11.04	3.29	11.38	3.31	
37	-10.0	9.06	1.16	10.24	1.18	10.80	1.19	11.50	1.20	12.36	1.22	12.74	1.22
	-5.0	9.06	1.21	10.24	1.24	10.80	1.25	11.50	1.26	12.36	1.27	12.74	1.28
	0.0	9.06	1.27	10.24	1.29	10.80	1.30	11.50	1.31	12.36	1.33	12.74	1.34
	5.0	9.06	1.41	10.24	1.44	10.80	1.45	11.50	1.46	12.36	1.48	12.74	1.49
	10.0	9.06	1.56	10.24	1.58	10.80	1.60	11.50	1.61	12.36	1.63	12.74	1.64
	15.0	9.06	2.14	10.24	2.18	10.80	2.20	11.50	2.22	12.36	2.25	12.74	2.26
	20.0	9.06	2.73	10.24	2.78	10.80	2.80	11.50	2.83	12.36	2.86	12.74	2.88
	25.0	9.06	3.01	10.24	3.06	10.80	3.08	11.50	3.12	12.36	3.15	12.74	3.17
	30.0	9.06	3.28	10.24	3.34	10.80	3.37	11.50	3.41	12.36	3.45	12.74	3.46
	35.0	9.06	3.51	10.24	3.57	10.80	3.60	11.50	3.64	12.36	3.68	12.74	3.70
	40.0	7.88	3.25	8.91	3.31	9.39	3.34	10.00	3.38	10.75	3.42	11.08	3.43
46.1	7.88	3.00	8.91	3.06	9.39	3.08	10.00	3.12	10.75	3.15	11.08	3.17	
36	-10.0	8.82	1.11	9.97	1.13	10.51	1.14	11.20	1.15	12.03	1.16	12.40	1.17
	-5.0	8.82	1.16	9.97	1.18	10.51	1.19	11.20	1.20	12.03	1.22	12.40	1.22
	0.0	8.82	1.21	9.97	1.23	10.51	1.24	11.20	1.26	12.03	1.27	12.40	1.28
	5.0	8.82	1.35	9.97	1.37	10.51	1.38	11.20	1.40	12.03	1.42	12.40	1.42
	10.0	8.82	1.49	9.97	1.51	10.51	1.53	11.20	1.54	12.03	1.56	12.40	1.57
	15.0	8.82	2.05	9.97	2.08	10.51	2.10	11.20	2.12	12.03	2.15	12.40	2.16
	20.0	8.82	2.61	9.97	2.65	10.51	2.68	11.20	2.70	12.03	2.74	12.40	2.75
	25.0	8.82	2.87	9.97	2.92	10.51	2.95	11.20	2.98	12.03	3.01	12.40	3.03
	30.0	8.82	3.14	9.97	3.19	10.51	3.22	11.20	3.26	12.03	3.29	12.40	3.31
	35.0	8.82	3.35	9.97	3.41	10.51	3.44	11.20	3.48	12.03	3.52	12.40	3.54
	40.0	7.67	3.11	8.67	3.17	9.14	3.19	9.70	3.23	10.46	3.26	10.78	3.28
46.1	7.67	2.87	8.67	2.92	9.14	2.95	9.70	2.98	10.46	3.01	10.78	3.03	
35	-10.0	8.57	1.06	9.69	1.08	10.21	1.09	10.90	1.10	11.69	1.11	12.05	1.12
	-5.0	8.57	1.11	9.69	1.13	10.21	1.14	10.90	1.15	11.69	1.16	12.05	1.17
	0.0	8.57	1.15	9.69	1.18	10.21	1.18	10.90	1.20	11.69	1.21	12.05	1.22
	5.0	8.57	1.29	9.69	1.31	10.21	1.32	10.90	1.34	11.69	1.35	12.05	1.36
	10.0	8.57	1.42	9.69	1.44	10.21	1.46	10.90	1.47	11.69	1.49	12.05	1.50
	15.0	8.57	1.95	9.69	1.99	10.21	2.00	10.90	2.03	11.69	2.05	12.05	2.06
	20.0	8.57	2.49	9.69	2.53	10.21	2.55	10.90	2.58	11.69	2.61	12.05	2.62
	25.0	8.57	2.74	9.69	2.79	10.21	2.81	10.90	2.84	11.69	2.88	12.05	2.89
	30.0	8.57	2.99	9.69	3.05	10.21	3.07	10.90	3.11	11.69	3.14	12.05	3.16
	35.0	8.57	3.20	9.69	3.25	10.21	3.28	10.90	3.32	11.69	3.35	12.05	3.37
	40.0	7.46	2.97	8.43	3.02	8.88	3.04	9.50	3.08	10.17	3.11	10.48	3.13
46.1	7.46	2.74	8.43	2.79	8.88	2.81	9.50	2.84	10.17	2.87	10.48	2.89	

OUTDOOR UNIT  
ROMH45AFXZJ

Indoor unit connecting capacity	Outdoor temperature	Indoor temperature											
		17.8 °CDB		21.1 °CDB		23.9 °CDB		26.7 °CDB		29.4 °CDB		32.2 °CDB	
		12.2 °CWB		15.6 °CWB		17.2 °CWB		19.4 °CWB		21.7 °CWB		22.8 °CWB	
kBtu/h	°CDB	TC	IP	TC	IP	TC	IP	TC	IP	TC	IP	TC	IP
34	-10.0	8.33	1.01	9.41	1.02	9.92	1.03	10.60	1.04	11.36	1.06	11.71	1.06
	-5.0	8.33	1.05	9.41	1.07	9.92	1.08	10.60	1.09	11.36	1.10	11.71	1.11
	0.0	8.33	1.10	9.41	1.12	9.92	1.13	10.60	1.14	11.36	1.15	11.71	1.16
	5.0	8.33	1.22	9.41	1.25	9.92	1.26	10.60	1.27	11.36	1.28	11.71	1.29
	10.0	8.33	1.35	9.41	1.37	9.92	1.39	10.60	1.40	11.36	1.42	11.71	1.42
	15.0	8.33	1.86	9.41	1.89	9.92	1.91	10.60	1.93	11.36	1.95	11.71	1.96
	20.0	8.33	2.37	9.41	2.41	9.92	2.43	10.60	2.45	11.36	2.48	11.71	2.50
	25.0	8.33	2.61	9.41	2.65	9.92	2.67	10.60	2.70	11.36	2.74	11.71	2.75
	30.0	8.33	2.85	9.41	2.90	9.92	2.92	10.60	2.95	11.36	2.99	11.71	3.00
	35.0	8.33	3.04	9.41	3.09	9.92	3.12	10.60	3.15	11.36	3.19	11.71	3.21
	40.0	7.24	2.82	8.19	2.87	8.63	2.90	9.20	2.93	9.88	2.96	10.18	2.98
	46.1	7.24	2.61	8.19	2.65	8.63	2.67	9.20	2.70	9.88	2.73	10.18	2.75

**NOTE:** Specifications are based on the following conditions.

- Power source of specifications: 230 V
- 2 or more indoor units should be connected.
- Pipe length: 24.6 ft (7.5 m), Height difference: 0 ft (0 m) [Outdoor unit - Indoor unit]
- The total ability of connected a indoor unit is from 34,000 Btu up to 54,000 Btu.
- Input in the table are calculated based on the maximum indoor unit input combinations.

## ■ Wall mounted type

### ● Cooling capacity in kBtu/h

- TC: Total Capacity (kBtu/h), SHC: Sensible Heat Capacity (kBtu/h).
- The data is based on the following conditions.
- Pipe length: 24.6 ft (7.5 m), Height difference: 0 ft (0 m) [Outdoor unit - Indoor unit]

#### MODEL: RIWH07AVFJ

Outdoor temperature	Indoor temperature (°FDB / °FWB)											
	64.0 / 54.0		70.0 / 60.0		75.0 / 63.0		80.0 / 67.0		85.0 / 71.0		90.0 / 73.0	
(°FDB)	TC	SHC	TC	SHC	TC	SHC	TC	SHC	TC	SHC	TC	SHC
14.0	5.88	4.12	6.65	4.70	7.01	5.41	7.50	6.08	8.02	6.64	8.27	7.61
23.0	5.88	4.12	6.65	4.70	7.01	5.41	7.50	6.08	8.02	6.64	8.27	7.61
32.0	5.88	4.12	6.65	4.70	7.01	5.41	7.50	6.08	8.02	6.64	8.27	7.61
41.0	5.88	4.12	6.65	4.70	7.01	5.41	7.50	6.08	8.02	6.64	8.27	7.61
50.0	5.88	4.12	6.65	4.70	7.01	5.41	7.50	6.08	8.02	6.64	8.27	7.61
59.0	5.88	4.12	6.65	4.70	7.01	5.41	7.50	6.08	8.02	6.64	8.27	7.61
67.0	5.88	4.12	6.65	4.70	7.01	5.41	7.50	6.08	8.02	6.64	8.27	7.61
77.0	5.88	4.12	6.65	4.70	7.01	5.41	7.50	6.08	8.02	6.64	8.27	7.61
87.0	5.88	4.12	6.65	4.70	7.01	5.41	7.50	6.08	8.02	6.64	8.27	7.61
95.0	5.88	4.12	6.65	4.70	7.01	5.41	7.50	6.08	8.02	6.64	8.27	7.61
104.0	5.11	3.12	5.78	3.55	6.09	4.09	6.52	4.60	6.97	5.03	7.19	5.76
115.0	4.35	2.25	4.92	2.57	5.18	2.96	5.55	3.32	5.93	3.64	6.11	4.17

#### MODEL: RIWH09AVFJ

Outdoor temperature	Indoor temperature (°FDB / °FWB)											
	64.0 / 54.0		70.0 / 60.0		75.0 / 63.0		80.0 / 67.0		85.0 / 71.0		90.0 / 73.0	
(°FDB)	TC	SHC	TC	SHC	TC	SHC	TC	SHC	TC	SHC	TC	SHC
14.0	7.53	5.27	8.51	6.01	8.97	6.92	9.60	7.78	10.26	8.50	10.58	9.74
23.0	7.53	5.27	8.51	6.01	8.97	6.92	9.60	7.78	10.26	8.50	10.58	9.74
32.0	7.53	5.27	8.51	6.01	8.97	6.92	9.60	7.78	10.26	8.50	10.58	9.74
41.0	7.53	5.27	8.51	6.01	8.97	6.92	9.60	7.78	10.26	8.50	10.58	9.74
50.0	7.53	5.27	8.51	6.01	8.97	6.92	9.60	7.78	10.26	8.50	10.58	9.74
59.0	7.53	5.27	8.51	6.01	8.97	6.92	9.60	7.78	10.26	8.50	10.58	9.74
67.0	7.53	5.27	8.51	6.01	8.97	6.92	9.60	7.78	10.26	8.50	10.58	9.74
77.0	7.53	5.27	8.51	6.01	8.97	6.92	9.60	7.78	10.26	8.50	10.58	9.74
87.0	7.53	5.27	8.51	6.01	8.97	6.92	9.60	7.78	10.26	8.50	10.58	9.74
95.0	7.53	5.27	8.51	6.01	8.97	6.92	9.60	7.78	10.26	8.50	10.58	9.74
104.0	6.55	3.99	7.40	4.55	7.80	5.24	8.35	5.88	8.93	6.44	9.20	7.37
115.0	5.57	2.89	6.29	3.29	6.63	3.79	7.10	4.26	7.59	4.65	7.83	5.33

#### MODEL: RIWH12AVFJ

Outdoor temperature	Indoor temperature (°FDB / °FWB)											
	64.0 / 54.0		70.0 / 60.0		75.0 / 63.0		80.0 / 67.0		85.0 / 71.0		90.0 / 73.0	
(°FDB)	TC	SHC	TC	SHC	TC	SHC	TC	SHC	TC	SHC	TC	SHC
14.0	10.04	6.60	11.34	7.52	11.96	8.66	12.80	9.73	13.68	10.64	14.11	12.19
23.0	10.04	6.60	11.34	7.52	11.96	8.66	12.80	9.73	13.68	10.64	14.11	12.19
32.0	10.04	6.60	11.34	7.52	11.96	8.66	12.80	9.73	13.68	10.64	14.11	12.19
41.0	10.04	6.60	11.34	7.52	11.96	8.66	12.80	9.73	13.68	10.64	14.11	12.19
50.0	10.04	6.60	11.34	7.52	11.96	8.66	12.80	9.73	13.68	10.64	14.11	12.19
59.0	10.04	6.60	11.34	7.52	11.96	8.66	12.80	9.73	13.68	10.64	14.11	12.19
67.0	10.04	6.60	11.34	7.52	11.96	8.66	12.80	9.73	13.68	10.64	14.11	12.19
77.0	10.04	6.60	11.34	7.52	11.96	8.66	12.80	9.73	13.68	10.64	14.11	12.19
87.0	10.04	6.60	11.34	7.52	11.96	8.66	12.80	9.73	13.68	10.64	14.11	12.19
95.0	10.04	6.60	11.34	7.52	11.96	8.66	12.80	9.73	13.68	10.64	14.11	12.19
104.0	8.73	4.99	9.87	5.69	10.40	6.55	11.13	7.36	11.90	8.05	12.27	9.22
115.0	7.42	3.61	8.39	4.12	8.84	4.74	9.47	5.32	10.12	5.82	10.43	6.67

**MODEL: RIWH15AVFJ**

Outdoor temperature	Indoor temperature (°FDB / °FWB)											
	64.0 / 54.0		70.0 / 60.0		75.0 / 63.0		80.0 / 67.0		85.0 / 71.0		90.0 / 73.0	
(°FDB)	TC	SHC	TC	SHC	TC	SHC	TC	SHC	TC	SHC	TC	SHC
14.0	12.54	8.14	14.18	9.28	14.94	10.68	16.00	12.00	17.10	13.12	17.63	15.04
23.0	12.54	8.14	14.18	9.28	14.94	10.68	16.00	12.00	17.10	13.12	17.63	15.04
32.0	12.54	8.14	14.18	9.28	14.94	10.68	16.00	12.00	17.10	13.12	17.63	15.04
41.0	12.54	8.14	14.18	9.28	14.94	10.68	16.00	12.00	17.10	13.12	17.63	15.04
50.0	12.54	8.14	14.18	9.28	14.94	10.68	16.00	12.00	17.10	13.12	17.63	15.04
59.0	12.54	8.14	14.18	9.28	14.94	10.68	16.00	12.00	17.10	13.12	17.63	15.04
67.0	12.54	8.14	14.18	9.28	14.94	10.68	16.00	12.00	17.10	13.12	17.63	15.04
77.0	12.54	8.14	14.18	9.28	14.94	10.68	16.00	12.00	17.10	13.12	17.63	15.04
87.0	12.54	8.14	14.18	9.28	14.94	10.68	16.00	12.00	17.10	13.12	17.63	15.04
95.0	12.54	8.14	14.18	9.28	14.94	10.68	16.00	12.00	17.10	13.12	17.63	15.04
104.0	10.91	6.16	12.33	7.02	13.00	8.08	13.92	9.08	14.88	9.93	15.34	11.38
115.0	9.28	4.45	10.49	5.08	11.05	5.84	11.84	6.57	12.65	7.18	13.04	8.23

OUTDOOR UNIT  
ROMH45AFZJJ

**MODEL: RIWH18AVFJ**

Outdoor temperature	Indoor temperature (°FDB / °FWB)											
	64.0 / 54.0		70.0 / 60.0		75.0 / 63.0		80.0 / 67.0		85.0 / 71.0		90.0 / 73.0	
(°FDB)	TC	SHC	TC	SHC	TC	SHC	TC	SHC	TC	SHC	TC	SHC
14.0	15.05	10.03	17.01	11.43	17.93	13.16	19.20	14.78	20.52	16.17	21.16	18.53
23.0	15.05	10.03	17.01	11.43	17.93	13.16	19.20	14.78	20.52	16.17	21.16	18.53
32.0	15.05	10.03	17.01	11.43	17.93	13.16	19.20	14.78	20.52	16.17	21.16	18.53
41.0	15.05	10.03	17.01	11.43	17.93	13.16	19.20	14.78	20.52	16.17	21.16	18.53
50.0	15.05	10.03	17.01	11.43	17.93	13.16	19.20	14.78	20.52	16.17	21.16	18.53
59.0	15.05	10.03	17.01	11.43	17.93	13.16	19.20	14.78	20.52	16.17	21.16	18.53
67.0	15.05	10.03	17.01	11.43	17.93	13.16	19.20	14.78	20.52	16.17	21.16	18.53
77.0	15.05	10.03	17.01	11.43	17.93	13.16	19.20	14.78	20.52	16.17	21.16	18.53
87.0	15.05	10.03	17.01	11.43	17.93	13.16	19.20	14.78	20.52	16.17	21.16	18.53
95.0	15.05	10.03	17.01	11.43	17.93	13.16	19.20	14.78	20.52	16.17	21.16	18.53
104.0	13.09	7.59	14.80	8.65	15.60	9.96	16.70	11.19	17.85	12.24	18.41	14.02
115.0	11.14	5.49	12.58	6.25	13.27	7.20	14.20	8.09	15.18	8.85	15.65	10.14

**MODEL: RIWH24AVFJ**

Outdoor temperature	Indoor temperature (°FDB / °FWB)											
	64.0 / 54.0		70.0 / 60.0		75.0 / 63.0		80.0 / 67.0		85.0 / 71.0		90.0 / 73.0	
(°FDB)	TC	SHC	TC	SHC	TC	SHC	TC	SHC	TC	SHC	TC	SHC
14.0	20.07	12.15	22.68	13.85	23.91	15.95	25.60	17.92	27.37	19.60	28.21	22.46
23.0	20.07	12.15	22.68	13.85	23.91	15.95	25.60	17.92	27.37	19.60	28.21	22.46
32.0	20.07	12.15	22.68	13.85	23.91	15.95	25.60	17.92	27.37	19.60	28.21	22.46
41.0	20.07	12.15	22.68	13.85	23.91	15.95	25.60	17.92	27.37	19.60	28.21	22.46
50.0	20.07	12.15	22.68	13.85	23.91	15.95	25.60	17.92	27.37	19.60	28.21	22.46
59.0	20.07	12.15	22.68	13.85	23.91	15.95	25.60	17.92	27.37	19.60	28.21	22.46
67.0	20.07	12.15	22.68	13.85	23.91	15.95	25.60	17.92	27.37	19.60	28.21	22.46
77.0	20.07	12.15	22.68	13.85	23.91	15.95	25.60	17.92	27.37	19.60	28.21	22.46
87.0	20.07	12.15	22.68	13.85	23.91	15.95	25.60	17.92	27.37	19.60	28.21	22.46
95.0	20.07	12.15	22.68	13.85	23.91	15.95	25.60	17.92	27.37	19.60	28.21	22.46
104.0	17.46	9.20	19.73	10.48	20.80	12.07	22.27	13.56	23.81	14.83	24.54	16.99
115.0	14.85	6.65	16.78	7.58	17.69	8.73	18.94	9.81	20.24	10.73	20.87	12.29

## ● Cooling capacity in kW

- TC: Total Capacity (kW), SHC: Sensible Heat Capacity (kW).
- The data is based on the following conditions:  
Pipe length: 24.6 ft (7.5 m), Height difference: 0 ft (0 m) [Outdoor unit - Indoor unit]

### MODEL: RIWH07AVFJ

Outdoor temperature	Indoor temperature (°CDB / °CWB)											
	17.8 / 12.2		21.1 / 15.6		23.9 / 17.2		26.7 / 19.4		29.4 / 21.7		32.2 / 22.8	
(°CDB)	TC	SHC	TC	SHC	TC	SHC	TC	SHC	TC	SHC	TC	SHC
-10.0	1.72	1.21	1.95	1.38	2.05	1.58	2.20	1.78	2.35	1.95	2.42	2.23
-5.0	1.72	1.21	1.95	1.38	2.05	1.58	2.20	1.78	2.35	1.95	2.42	2.23
0.0	1.72	1.21	1.95	1.38	2.05	1.58	2.20	1.78	2.35	1.95	2.42	2.23
5.0	1.72	1.21	1.95	1.38	2.05	1.58	2.20	1.78	2.35	1.95	2.42	2.23
10.0	1.72	1.21	1.95	1.38	2.05	1.58	2.20	1.78	2.35	1.95	2.42	2.23
15.0	1.72	1.21	1.95	1.38	2.05	1.58	2.20	1.78	2.35	1.95	2.42	2.23
20.0	1.72	1.21	1.95	1.38	2.05	1.58	2.20	1.78	2.35	1.95	2.42	2.23
25.0	1.72	1.21	1.95	1.38	2.05	1.58	2.20	1.78	2.35	1.95	2.42	2.23
30.0	1.72	1.21	1.95	1.38	2.05	1.58	2.20	1.78	2.35	1.95	2.42	2.23
35.0	1.72	1.21	1.95	1.38	2.05	1.58	2.20	1.78	2.35	1.95	2.42	2.23
40.0	1.50	0.91	1.69	1.04	1.79	1.20	1.91	1.35	2.04	1.47	2.11	1.69
46.1	1.27	0.66	1.44	0.75	1.52	0.87	1.63	0.97	1.74	1.07	1.79	1.22

### MODEL: RIWH09AVFJ

Outdoor temperature	Indoor temperature (°CDB / °CWB)											
	17.8 / 12.2		21.1 / 15.6		23.9 / 17.2		26.7 / 19.4		29.4 / 21.7		32.2 / 22.8	
(°CDB)	TC	SHC	TC	SHC	TC	SHC	TC	SHC	TC	SHC	TC	SHC
-10.0	2.21	1.55	2.49	1.76	2.63	2.03	2.81	2.28	3.01	2.49	3.10	2.86
-5.0	2.21	1.55	2.49	1.76	2.63	2.03	2.81	2.28	3.01	2.49	3.10	2.86
0.0	2.21	1.55	2.49	1.76	2.63	2.03	2.81	2.28	3.01	2.49	3.10	2.86
5.0	2.21	1.55	2.49	1.76	2.63	2.03	2.81	2.28	3.01	2.49	3.10	2.86
10.0	2.21	1.55	2.49	1.76	2.63	2.03	2.81	2.28	3.01	2.49	3.10	2.86
15.0	2.21	1.55	2.49	1.76	2.63	2.03	2.81	2.28	3.01	2.49	3.10	2.86
20.0	2.21	1.55	2.49	1.76	2.63	2.03	2.81	2.28	3.01	2.49	3.10	2.86
25.0	2.21	1.55	2.49	1.76	2.63	2.03	2.81	2.28	3.01	2.49	3.10	2.86
30.0	2.21	1.55	2.49	1.76	2.63	2.03	2.81	2.28	3.01	2.49	3.10	2.86
35.0	2.21	1.55	2.49	1.76	2.63	2.03	2.81	2.28	3.01	2.49	3.10	2.86
40.0	1.92	1.17	2.17	1.33	2.29	1.53	2.45	1.72	2.62	1.89	2.70	2.16
46.1	1.63	0.85	1.84	0.96	1.94	1.11	2.08	1.25	2.22	1.36	2.29	1.56

### MODEL: RIWH12AVFJ

Outdoor temperature	Indoor temperature (°CDB / °CWB)											
	17.8 / 12.2		21.1 / 15.6		23.9 / 17.2		26.7 / 19.4		29.4 / 21.7		32.2 / 22.8	
(°CDB)	TC	SHC	TC	SHC	TC	SHC	TC	SHC	TC	SHC	TC	SHC
-10.0	2.94	1.93	3.32	2.20	3.50	2.54	3.75	2.85	4.01	3.12	4.13	3.57
-5.0	2.94	1.93	3.32	2.20	3.50	2.54	3.75	2.85	4.01	3.12	4.13	3.57
0.0	2.94	1.93	3.32	2.20	3.50	2.54	3.75	2.85	4.01	3.12	4.13	3.57
5.0	2.94	1.93	3.32	2.20	3.50	2.54	3.75	2.85	4.01	3.12	4.13	3.57
10.0	2.94	1.93	3.32	2.20	3.50	2.54	3.75	2.85	4.01	3.12	4.13	3.57
15.0	2.94	1.93	3.32	2.20	3.50	2.54	3.75	2.85	4.01	3.12	4.13	3.57
20.0	2.94	1.93	3.32	2.20	3.50	2.54	3.75	2.85	4.01	3.12	4.13	3.57
25.0	2.94	1.93	3.32	2.20	3.50	2.54	3.75	2.85	4.01	3.12	4.13	3.57
30.0	2.94	1.93	3.32	2.20	3.50	2.54	3.75	2.85	4.01	3.12	4.13	3.57
35.0	2.94	1.93	3.32	2.20	3.50	2.54	3.75	2.85	4.01	3.12	4.13	3.57
40.0	2.56	1.46	2.89	1.67	3.05	1.92	3.26	2.16	3.49	2.36	3.60	2.70
46.1	2.18	1.06	2.46	1.21	2.59	1.39	2.78	1.56	2.97	1.71	3.06	1.96

**MODEL: RIWH15AVFJ**

Outdoor temperature	Indoor temperature (°CDB / °CWB)											
	17.8 / 12.2		21.1 / 15.6		23.9 / 17.2		26.7 / 19.4		29.4 / 21.7		32.2 / 22.8	
(°CDB)	TC	SHC	TC	SHC	TC	SHC	TC	SHC	TC	SHC	TC	SHC
-10.0	3.68	2.39	4.15	2.72	4.38	3.13	4.69	3.52	5.01	3.85	5.17	4.41
-5.0	3.68	2.39	4.15	2.72	4.38	3.13	4.69	3.52	5.01	3.85	5.17	4.41
0.0	3.68	2.39	4.15	2.72	4.38	3.13	4.69	3.52	5.01	3.85	5.17	4.41
5.0	3.68	2.39	4.15	2.72	4.38	3.13	4.69	3.52	5.01	3.85	5.17	4.41
10.0	3.68	2.39	4.15	2.72	4.38	3.13	4.69	3.52	5.01	3.85	5.17	4.41
15.0	3.68	2.39	4.15	2.72	4.38	3.13	4.69	3.52	5.01	3.85	5.17	4.41
20.0	3.68	2.39	4.15	2.72	4.38	3.13	4.69	3.52	5.01	3.85	5.17	4.41
25.0	3.68	2.39	4.15	2.72	4.38	3.13	4.69	3.52	5.01	3.85	5.17	4.41
30.0	3.68	2.39	4.15	2.72	4.38	3.13	4.69	3.52	5.01	3.85	5.17	4.41
35.0	3.68	2.39	4.15	2.72	4.38	3.13	4.69	3.52	5.01	3.85	5.17	4.41
40.0	3.20	1.80	3.61	2.06	3.81	2.37	4.08	2.66	4.36	2.91	4.50	3.33
46.1	2.72	1.31	3.07	1.49	3.24	1.71	3.47	1.92	3.71	2.10	3.82	2.41

**MODEL: RIWH18AVFJ**

Outdoor temperature	Indoor temperature (°CDB / °CWB)											
	17.8 / 12.2		21.1 / 15.6		23.9 / 17.2		26.7 / 19.4		29.4 / 21.7		32.2 / 22.8	
(°CDB)	TC	SHC	TC	SHC	TC	SHC	TC	SHC	TC	SHC	TC	SHC
-10.0	4.41	2.94	4.99	3.35	5.26	3.86	5.63	4.33	6.02	4.74	6.20	5.43
-5.0	4.41	2.94	4.99	3.35	5.26	3.86	5.63	4.33	6.02	4.74	6.20	5.43
0.0	4.41	2.94	4.99	3.35	5.26	3.86	5.63	4.33	6.02	4.74	6.20	5.43
5.0	4.41	2.94	4.99	3.35	5.26	3.86	5.63	4.33	6.02	4.74	6.20	5.43
10.0	4.41	2.94	4.99	3.35	5.26	3.86	5.63	4.33	6.02	4.74	6.20	5.43
15.0	4.41	2.94	4.99	3.35	5.26	3.86	5.63	4.33	6.02	4.74	6.20	5.43
20.0	4.41	2.94	4.99	3.35	5.26	3.86	5.63	4.33	6.02	4.74	6.20	5.43
25.0	4.41	2.94	4.99	3.35	5.26	3.86	5.63	4.33	6.02	4.74	6.20	5.43
30.0	4.41	2.94	4.99	3.35	5.26	3.86	5.63	4.33	6.02	4.74	6.20	5.43
35.0	4.41	2.94	4.99	3.35	5.26	3.86	5.63	4.33	6.02	4.74	6.20	5.43
40.0	3.84	2.22	4.34	2.53	4.57	2.92	4.89	3.28	5.23	3.59	5.39	4.11
46.1	3.26	1.61	3.69	1.83	3.89	2.11	4.16	2.37	4.45	2.59	4.59	2.97

**MODEL: RIWH24AVFJ**

Outdoor temperature	Indoor temperature (°CDB / °CWB)											
	17.8 / 12.2		21.1 / 15.6		23.9 / 17.2		26.7 / 19.4		29.4 / 21.7		32.2 / 22.8	
(°CDB)	TC	SHC	TC	SHC	TC	SHC	TC	SHC	TC	SHC	TC	SHC
-10.0	5.88	3.56	6.65	4.06	7.01	4.67	7.50	5.25	8.02	5.74	8.27	6.58
-5.0	5.88	3.56	6.65	4.06	7.01	4.67	7.50	5.25	8.02	5.74	8.27	6.58
0.0	5.88	3.56	6.65	4.06	7.01	4.67	7.50	5.25	8.02	5.74	8.27	6.58
5.0	5.88	3.56	6.65	4.06	7.01	4.67	7.50	5.25	8.02	5.74	8.27	6.58
10.0	5.88	3.56	6.65	4.06	7.01	4.67	7.50	5.25	8.02	5.74	8.27	6.58
15.0	5.88	3.56	6.65	4.06	7.01	4.67	7.50	5.25	8.02	5.74	8.27	6.58
20.0	5.88	3.56	6.65	4.06	7.01	4.67	7.50	5.25	8.02	5.74	8.27	6.58
25.0	5.88	3.56	6.65	4.06	7.01	4.67	7.50	5.25	8.02	5.74	8.27	6.58
30.0	5.88	3.56	6.65	4.06	7.01	4.67	7.50	5.25	8.02	5.74	8.27	6.58
35.0	5.88	3.56	6.65	4.06	7.01	4.67	7.50	5.25	8.02	5.74	8.27	6.58
40.0	5.12	2.70	5.78	3.07	6.10	3.54	6.53	3.97	6.98	4.35	7.19	4.98
46.1	4.35	1.95	4.92	2.22	5.18	2.56	5.55	2.87	5.93	3.14	6.12	3.60

OUTDOOR UNIT  
ROMH45AFZJJ

## 6-3. Heating capacity

### Model: ROMH45AFXZJ

NOTE: Values mentioned in the table are calculated based on the maximum capacity.

#### Heating in kBtu/h

TC: Total Capacity (kBtu/h), IP: Input Power (kW)

Indoor unit connecting capacity kBtu/h	Outdoor temperature		Indoor temperature									
			60 °FDB		65 °FDB		70 °FDB		75 °FDB		78 °FDB	
	°FDB	°FWB	TC	IP	TC	IP	TC	IP	TC	IP	TC	IP
54	5	3	33.1	4.70	32.3	4.80	31.5	4.90	30.8	5.00	30.0	5.10
	14	12	37.3	4.70	36.5	4.80	35.6	4.90	34.7	5.00	33.8	5.10
	23	19	41.6	4.70	40.6	4.80	39.6	4.90	38.6	5.00	37.6	5.10
	32	28	48.4	4.70	47.3	4.80	46.1	4.90	45.0	5.00	43.8	5.10
	41	37	55.3	4.70	54.0	4.80	52.7	4.90	51.3	5.00	50.0	5.10
	47	43	56.7	4.24	55.4	4.32	54.0	4.41	52.7	4.50	51.3	4.59
	50	47	56.7	4.24	55.4	4.32	54.0	4.41	52.7	4.50	51.3	4.59
	59	50	56.7	3.95	55.4	4.03	54.0	4.11	52.7	4.19	51.3	4.27
	68	59	54.1	3.42	52.8	3.49	51.5	3.56	50.2	3.63	49.0	3.70
75	65	51.6	3.12	50.3	3.19	49.1	3.25	47.9	3.32	46.7	3.38	
53	5	3	33.1	4.70	32.3	4.80	31.5	4.90	30.8	5.00	30.0	5.10
	14	12	37.3	4.70	36.5	4.80	35.6	4.90	34.7	5.00	33.8	5.10
	23	19	41.6	4.70	40.6	4.80	39.6	4.90	38.6	5.00	37.6	5.10
	32	28	48.4	4.70	47.3	4.80	46.1	4.90	45.0	5.00	43.8	5.10
	41	37	55.3	4.70	54.0	4.80	52.7	4.90	51.3	5.00	50.0	5.10
	47	43	56.7	4.24	55.4	4.32	54.0	4.41	52.7	4.50	51.3	4.59
	50	47	56.7	4.24	55.4	4.32	54.0	4.41	52.7	4.50	51.3	4.59
	59	50	56.7	3.95	55.4	4.03	54.0	4.11	52.7	4.19	51.3	4.27
	68	59	54.1	3.42	52.8	3.49	51.5	3.56	50.2	3.63	49.0	3.70
75	65	51.6	3.12	50.3	3.19	49.1	3.25	47.9	3.32	46.7	3.38	
52	5	3	33.1	4.70	32.3	4.80	31.5	4.90	30.8	5.00	30.0	5.10
	14	12	37.3	4.70	36.5	4.80	35.6	4.90	34.7	5.00	33.8	5.10
	23	19	41.6	4.70	40.6	4.80	39.6	4.90	38.6	5.00	37.6	5.10
	32	28	48.4	4.70	47.3	4.80	46.1	4.90	45.0	5.00	43.8	5.10
	41	37	55.3	4.70	54.0	4.80	52.7	4.90	51.3	5.00	50.0	5.10
	47	43	56.7	4.24	55.4	4.32	54.0	4.41	52.7	4.50	51.3	4.59
	50	47	56.7	4.24	55.4	4.32	54.0	4.41	52.7	4.50	51.3	4.59
	59	50	56.7	3.95	55.4	4.03	54.0	4.11	52.7	4.19	51.3	4.27
	68	59	54.1	3.42	52.8	3.49	51.5	3.56	50.2	3.63	49.0	3.70
75	65	51.6	3.12	50.3	3.19	49.1	3.25	47.9	3.32	46.7	3.38	
51	5	3	33.1	4.70	32.3	4.80	31.5	4.90	30.8	5.00	30.0	5.10
	14	12	37.3	4.70	36.5	4.80	35.6	4.90	34.7	5.00	33.8	5.10
	23	19	41.6	4.70	40.6	4.80	39.6	4.90	38.6	5.00	37.6	5.10
	32	28	48.4	4.70	47.3	4.80	46.1	4.90	45.0	5.00	43.8	5.10
	41	37	55.3	4.70	54.0	4.80	52.7	4.90	51.3	5.00	50.0	5.10
	47	43	56.7	4.24	55.4	4.32	54.0	4.41	52.7	4.50	51.3	4.59
	50	47	56.7	4.24	55.4	4.32	54.0	4.41	52.7	4.50	51.3	4.59
	59	50	56.7	3.95	55.4	4.03	54.0	4.11	52.7	4.19	51.3	4.27
	68	59	54.1	3.42	52.8	3.49	51.5	3.56	50.2	3.63	49.0	3.70
75	65	51.6	3.12	50.3	3.19	49.1	3.25	47.9	3.32	46.7	3.38	
50	5	3	33.1	4.70	32.3	4.80	31.5	4.90	30.8	5.00	30.0	5.10
	14	12	37.3	4.70	36.5	4.80	35.6	4.90	34.7	5.00	33.8	5.10
	23	19	41.6	4.70	40.6	4.80	39.6	4.90	38.6	5.00	37.6	5.10
	32	28	48.4	4.70	47.3	4.80	46.1	4.90	45.0	5.00	43.8	5.10
	41	37	55.3	4.70	54.0	4.80	52.7	4.90	51.3	5.00	50.0	5.10
	47	43	56.7	4.24	55.4	4.32	54.0	4.41	52.7	4.50	51.3	4.59
	50	47	56.7	4.24	55.4	4.32	54.0	4.41	52.7	4.50	51.3	4.59
	59	50	56.7	3.95	55.4	4.03	54.0	4.11	52.7	4.19	51.3	4.27
	68	59	54.1	3.42	52.8	3.49	51.5	3.56	50.2	3.63	49.0	3.70
75	65	51.6	3.12	50.3	3.19	49.1	3.25	47.9	3.32	46.7	3.38	
49	5	3	33.1	4.70	32.3	4.80	31.5	4.90	30.8	5.00	30.0	5.10
	14	12	37.3	4.70	36.5	4.80	35.6	4.90	34.7	5.00	33.8	5.10
	23	19	41.6	4.70	40.6	4.80	39.6	4.90	38.6	5.00	37.6	5.10
	32	28	48.4	4.70	47.3	4.80	46.1	4.90	45.0	5.00	43.8	5.10
	41	37	55.3	4.70	54.0	4.80	52.7	4.90	51.3	5.00	50.0	5.10
	47	43	56.7	4.24	55.4	4.32	54.0	4.41	52.7	4.50	51.3	4.59
	50	47	56.7	4.24	55.4	4.32	54.0	4.41	52.7	4.50	51.3	4.59
	59	50	56.7	3.95	55.4	4.03	54.0	4.11	52.7	4.19	51.3	4.27
	68	59	54.1	3.42	52.8	3.49	51.5	3.56	50.2	3.63	49.0	3.70
75	65	51.6	3.12	50.3	3.19	49.1	3.25	47.9	3.32	46.7	3.38	
48	5	3	33.1	4.70	32.3	4.80	31.5	4.90	30.8	5.00	30.0	5.10
	14	12	37.3	4.70	36.5	4.80	35.6	4.90	34.7	5.00	33.8	5.10
	23	19	41.6	4.70	40.6	4.80	39.6	4.90	38.6	5.00	37.6	5.10
	32	28	48.4	4.70	47.3	4.80	46.1	4.90	45.0	5.00	43.8	5.10
	41	37	55.3	4.70	54.0	4.80	52.7	4.90	51.3	5.00	50.0	5.10
	47	43	56.7	4.24	55.4	4.32	54.0	4.41	52.7	4.50	51.3	4.59
	50	47	56.7	4.24	55.4	4.32	54.0	4.41	52.7	4.50	51.3	4.59
	59	50	56.7	3.95	55.4	4.03	54.0	4.11	52.7	4.19	51.3	4.27
	68	59	54.1	3.42	52.8	3.49	51.5	3.56	50.2	3.63	49.0	3.70
75	65	51.6	3.12	50.3	3.19	49.1	3.25	47.9	3.32	46.7	3.38	

OUTDOOR UNIT  
ROMH45AFXZJ

Indoor unit connect- ing capacity	Outdoor temperature		Indoor temperature									
			60 °FDB		65 °FDB		70 °FDB		75 °FDB		78 °FDB	
	kBtu/h	°FDB	°FWB	TC	IP	TC	IP	TC	IP	TC	IP	TC
47	5	3	33.1	4.70	32.3	4.80	31.5	4.90	30.8	5.00	30.0	5.10
	14	12	37.3	4.70	36.5	4.80	35.6	4.90	34.7	5.00	33.8	5.10
	23	19	41.6	4.70	40.6	4.80	39.6	4.90	38.6	5.00	37.6	5.10
	32	28	48.4	4.70	47.3	4.80	46.1	4.90	45.0	5.00	43.8	5.10
	41	37	55.3	4.70	54.0	4.80	52.7	4.90	51.3	5.00	50.0	5.10
	47	43	56.7	4.24	55.4	4.32	54.0	4.41	52.7	4.50	51.3	4.59
	50	47	56.7	4.24	55.4	4.32	54.0	4.41	52.7	4.50	51.3	4.59
	59	50	56.7	3.95	55.4	4.03	54.0	4.11	52.7	4.19	51.3	4.27
	68	59	54.1	3.42	52.8	3.49	51.5	3.56	50.2	3.63	49.0	3.70
	75	65	51.6	3.12	50.3	3.19	49.1	3.25	47.9	3.32	46.7	3.38
46	5	3	33.1	4.70	32.3	4.80	31.5	4.90	30.8	5.00	30.0	5.10
	14	12	37.3	4.70	36.5	4.80	35.6	4.90	34.7	5.00	33.8	5.10
	23	19	41.6	4.70	40.6	4.80	39.6	4.90	38.6	5.00	37.6	5.10
	32	28	48.4	4.70	47.3	4.80	46.1	4.90	45.0	5.00	43.8	5.10
	41	37	55.3	4.70	54.0	4.80	52.7	4.90	51.3	5.00	50.0	5.10
	47	43	56.7	4.24	55.4	4.32	54.0	4.41	52.7	4.50	51.3	4.59
	50	47	56.7	4.24	55.4	4.32	54.0	4.41	52.7	4.50	51.3	4.59
	59	50	56.7	3.95	55.4	4.03	54.0	4.11	52.7	4.19	51.3	4.27
	68	59	54.1	3.42	52.8	3.49	51.5	3.56	50.2	3.63	49.0	3.70
	75	65	51.6	3.12	50.3	3.19	49.1	3.25	47.9	3.32	46.7	3.38
45	5	3	33.1	4.70	32.3	4.80	31.5	4.90	30.8	5.00	30.0	5.10
	14	12	37.3	4.70	36.5	4.80	35.6	4.90	34.7	5.00	33.8	5.10
	23	19	41.6	4.70	40.6	4.80	39.6	4.90	38.6	5.00	37.6	5.10
	32	28	48.4	4.70	47.3	4.80	46.1	4.90	45.0	5.00	43.8	5.10
	41	37	55.3	4.70	54.0	4.80	52.7	4.90	51.3	5.00	50.0	5.10
	47	43	56.7	4.24	55.4	4.32	54.0	4.41	52.7	4.50	51.3	4.59
	50	47	56.7	4.24	55.4	4.32	54.0	4.41	52.7	4.50	51.3	4.59
	59	50	56.7	3.95	55.4	4.03	54.0	4.11	52.7	4.19	51.3	4.27
	68	59	54.1	3.42	52.8	3.49	51.5	3.56	50.2	3.63	49.0	3.70
	75	65	51.6	3.12	50.3	3.19	49.1	3.25	47.9	3.32	46.7	3.38
44	5	3	32.4	4.60	31.6	4.69	30.8	4.79	30.1	4.89	29.3	4.98
	14	12	36.5	4.60	35.6	4.69	34.8	4.79	33.9	4.89	33.0	4.98
	23	19	40.6	4.60	39.7	4.69	38.7	4.79	37.7	4.89	36.8	4.98
	32	28	47.4	4.60	46.2	4.69	45.1	4.79	44.0	4.89	42.8	4.98
	41	37	54.1	4.60	52.8	4.69	51.5	4.79	50.2	4.89	48.9	4.98
	47	43	55.4	4.14	54.1	4.22	52.8	4.31	51.5	4.39	50.2	4.48
	50	47	55.4	4.14	54.1	4.22	52.8	4.31	51.5	4.39	50.2	4.48
	59	50	55.4	3.85	54.1	3.93	52.8	4.01	51.5	4.09	50.2	4.17
	68	59	52.9	3.34	51.6	3.41	50.4	3.48	49.1	3.55	47.9	3.61
	75	65	50.4	3.05	49.2	3.11	48.0	3.18	46.8	3.24	45.6	3.30
43	5	3	31.6	4.48	30.9	4.58	30.1	4.67	29.4	4.76	28.6	4.86
	14	12	35.7	4.48	34.8	4.58	34.0	4.67	33.1	4.76	32.3	4.86
	23	19	39.7	4.48	38.8	4.58	37.8	4.67	36.9	4.76	35.9	4.86
	32	28	46.3	4.48	45.2	4.58	44.1	4.67	43.0	4.76	41.9	4.86
	41	37	52.8	4.48	51.6	4.58	50.3	4.67	49.1	4.76	47.8	4.86
	47	43	54.2	4.04	52.9	4.12	51.6	4.21	50.3	4.29	49.0	4.37
	50	47	54.2	4.04	52.9	4.12	51.6	4.21	50.3	4.29	49.0	4.37
	59	50	54.2	3.76	52.9	3.84	51.6	3.92	50.3	4.00	49.0	4.07
	68	59	51.7	3.26	50.5	3.32	49.2	3.39	48.0	3.46	46.8	3.53
	75	65	49.3	2.98	48.1	3.04	46.9	3.10	45.8	3.16	44.6	3.22
42	5	3	30.9	4.38	30.2	4.47	29.4	4.56	28.7	4.65	28.0	4.74
	14	12	34.9	4.38	34.0	4.47	33.2	4.56	32.4	4.65	31.5	4.74
	23	19	38.8	4.38	37.9	4.47	36.9	4.56	36.0	4.65	35.1	4.74
	32	28	45.2	4.38	44.1	4.47	43.0	4.56	42.0	4.65	40.9	4.74
	41	37	51.6	4.38	50.4	4.47	49.1	4.56	47.9	4.65	46.7	4.74
	47	43	52.9	3.94	51.7	4.02	50.4	4.10	49.1	4.18	47.9	4.27
	50	47	52.9	3.94	51.7	4.02	50.4	4.10	49.1	4.18	47.9	4.27
	59	50	52.9	3.67	51.7	3.74	50.4	3.82	49.1	3.90	47.9	3.97
	68	59	50.5	3.18	49.3	3.24	48.1	3.31	46.9	3.37	45.7	3.44
	75	65	48.1	2.90	47.0	2.96	45.8	3.02	44.7	3.08	43.6	3.15
41	5	3	30.2	4.26	29.5	4.35	28.7	4.44	28.0	4.53	27.3	4.62
	14	12	34.0	4.26	33.2	4.35	32.4	4.44	31.6	4.53	30.8	4.62
	23	19	37.9	4.26	37.0	4.35	36.1	4.44	35.2	4.53	34.3	4.62
	32	28	44.1	4.26	43.1	4.35	42.0	4.44	41.0	4.53	39.9	4.62
	41	37	50.4	4.26	49.2	4.35	48.0	4.44	46.8	4.53	45.6	4.62
	47	43	51.7	3.84	50.4	3.92	49.2	4.00	48.0	4.08	46.7	4.16
	50	47	51.7	3.84	50.4	3.92	49.2	4.00	48.0	4.08	46.7	4.16
	59	50	51.7	3.58	50.4	3.65	49.2	3.72	48.0	3.80	46.7	3.87
	68	59	49.3	3.10	48.1	3.16	47.0	3.23	45.8	3.29	44.6	3.35
	75	65	47.0	2.83	45.9	2.89	44.8	2.95	43.6	3.01	42.5	3.07
40	5	3	29.4	4.16	28.7	4.24	28.0	4.33	27.3	4.42	26.6	4.50
	14	12	33.2	4.16	32.4	4.24	31.6	4.33	30.8	4.42	30.0	4.50
	23	19	36.9	4.16	36.1	4.24	35.2	4.33	34.3	4.42	33.4	4.50
	32	28	43.0	4.16	42.0	4.24	41.0	4.33	40.0	4.42	38.9	4.50
	41	37	49.1	4.16	48.0	4.24	46.8	4.33	45.6	4.42	44.5	4.50
	47	43	50.4	3.74	49.2	3.82	48.0	3.89	46.8	3.97	45.6	4.05
	50	47	50.4	3.74	49.2	3.82	48.0	3.89	46.8	3.97	45.6	4.05
	59	50	50.4	3.48	49.2	3.56	48.0	3.63	46.8	3.70	45.6	3.77
	68	59	48.1	3.02	47.0	3.08	45.8	3.14	44.7	3.20	43.5	3.27
	75	65	45.8	2.76	44.8	2.81	43.7	2.87	42.6	2.93	41.5	2.99
39	5	3	28.7	4.05	28.0	4.14	27.3	4.22	26.7	4.30	26.0	4.39
	14	12	32.4	4.05	31.6	4.14	30.8	4.22	30.1	4.30	29.3	4.39
	23	19	36.0	4.05	35.2	4.14	34.3	4.22	33.5	4.30	32.6	4.39
	32	28	42.0	4.05	41.0	4.14	40.0	4.22	39.0	4.30	38.0	4.39
	41	37	47.9	4.05	46.8	4.14	45.6	4.22	44.5	4.30	43.4	4.39
	47	43	49.1	3.64	48.0	3.72	46.8	3.79	45.6	3.87	44.5	3.94
	50	47	49.1	3.64	48.0	3.72	46.8	3.79	45.6	3.87	44.5	3.94
	59	50	49.1	3.39	48.0	3.46	46.8	3.53	45.6	3.60	44.5	3.67
	68	59	46.9	2.94	45.8	3.00	44.7	3.06	43.5	3.12	42.4	3.18
	75	65	44.7	2.68	43.6	2.74	42.6	2.80	41.5	2.85	40.4	2.91



Indoor unit connecting capacity	Outdoor temperature		Indoor temperature									
			60 °FDB		65 °FDB		70 °FDB		75 °FDB		78 °FDB	
	°FDB	°FWB	TC	IP	TC	IP	TC	IP	TC	IP	TC	IP
38	5	3	28.0	3.93	27.3	4.01	26.6	4.10	26.0	4.18	25.3	4.26
	14	12	31.5	3.93	30.8	4.01	30.0	4.10	29.3	4.18	28.5	4.26
	23	19	35.1	3.93	34.3	4.01	33.4	4.10	32.6	4.18	31.8	4.26
	32	28	40.9	3.93	39.9	4.01	38.9	4.10	38.0	4.18	37.0	4.26
	41	37	46.7	3.93	45.6	4.01	44.5	4.10	43.4	4.18	42.2	4.26
	47	43	47.9	3.54	46.7	3.61	45.6	3.69	44.5	3.76	43.3	3.84
	50	47	47.9	3.54	46.7	3.61	45.6	3.69	44.5	3.76	43.3	3.84
	59	50	47.9	3.30	46.7	3.37	45.6	3.44	44.5	3.50	43.3	3.57
	68	59	45.7	2.86	44.6	2.92	43.5	2.97	42.4	3.03	41.3	3.09
75	65	43.6	2.61	42.5	2.66	41.5	2.72	40.4	2.77	39.4	2.83	
37	5	3	27.2	3.83	26.6	3.91	25.9	3.99	25.3	4.07	24.6	4.15
	14	12	30.7	3.83	30.0	3.91	29.2	3.99	28.5	4.07	27.8	4.15
	23	19	34.2	3.83	33.4	3.91	32.6	3.99	31.7	4.07	30.9	4.15
	32	28	39.8	3.83	38.9	3.91	37.9	3.99	37.0	4.07	36.0	4.15
	41	37	45.5	3.83	44.4	3.91	43.3	3.99	42.2	4.07	41.1	4.15
	47	43	46.6	3.44	45.5	3.51	44.4	3.58	43.3	3.66	42.2	3.73
	50	47	46.6	3.44	45.5	3.51	44.4	3.58	43.3	3.66	42.2	3.73
	59	50	46.6	3.21	45.5	3.27	44.4	3.34	43.3	3.41	42.2	3.47
	68	59	44.5	2.78	43.4	2.83	42.4	2.89	41.3	2.95	40.3	3.01
75	65	42.4	2.54	41.4	2.59	40.4	2.64	39.4	2.70	38.4	2.75	
36	5	3	26.5	3.72	25.9	3.79	25.2	3.87	24.6	3.95	24.0	4.02
	14	12	29.9	3.72	29.2	3.79	28.5	3.87	27.7	3.95	27.0	4.02
	23	19	33.3	3.72	32.5	3.79	31.7	3.87	30.9	3.95	30.1	4.02
	32	28	38.7	3.72	37.8	3.79	36.9	3.87	36.0	3.95	35.1	4.02
	41	37	44.2	3.72	43.2	3.79	42.1	3.87	41.1	3.95	40.0	4.02
	47	43	45.4	3.34	44.3	3.41	43.2	3.48	42.1	3.55	41.0	3.62
	50	47	45.4	3.34	44.3	3.41	43.2	3.48	42.1	3.55	41.0	3.62
	59	50	45.4	3.11	44.3	3.18	43.2	3.24	42.1	3.31	41.0	3.37
	68	59	43.3	2.70	42.3	2.75	41.2	2.81	40.2	2.86	39.2	2.92
75	65	41.3	2.46	40.3	2.52	39.3	2.57	38.3	2.62	37.3	2.67	
35	5	3	25.8	3.60	25.1	3.68	24.5	3.75	23.9	3.83	23.3	3.90
	14	12	29.0	3.60	28.4	3.68	27.7	3.75	27.0	3.83	26.3	3.90
	23	19	32.3	3.60	31.6	3.68	30.8	3.75	30.0	3.83	29.3	3.90
	32	28	37.7	3.60	36.8	3.68	35.9	3.75	35.0	3.83	34.1	3.90
	41	37	43.0	3.60	42.0	3.68	41.0	3.75	39.9	3.83	38.9	3.90
	47	43	44.1	3.24	43.1	3.31	42.0	3.38	41.0	3.44	39.9	3.51
	50	47	44.1	3.24	43.1	3.31	42.0	3.38	41.0	3.44	39.9	3.51
	59	50	44.1	3.02	43.1	3.08	42.0	3.15	41.0	3.21	39.9	3.27
	68	59	42.1	2.62	41.1	2.67	40.1	2.72	39.1	2.78	38.1	2.83
75	65	40.1	2.39	39.2	2.44	38.2	2.49	37.3	2.54	36.3	2.59	
34	5	3	25.0	3.49	24.4	3.57	23.8	3.64	23.2	3.71	22.6	3.79
	14	12	28.2	3.49	27.5	3.57	26.9	3.64	26.2	3.71	25.5	3.79
	23	19	31.4	3.49	30.7	3.57	29.9	3.64	29.2	3.71	28.4	3.79
	32	28	36.6	3.49	35.7	3.57	34.8	3.64	34.0	3.71	33.1	3.79
	41	37	41.8	3.49	40.8	3.57	39.8	3.64	38.8	3.71	37.8	3.79
	47	43	42.8	3.15	41.8	3.21	40.8	3.28	39.8	3.34	38.8	3.41
	50	47	42.8	3.15	41.8	3.21	40.8	3.28	39.8	3.34	38.8	3.41
	59	50	42.8	2.93	41.8	2.99	40.8	3.05	39.8	3.11	38.8	3.17
	68	59	40.9	2.54	39.9	2.59	38.9	2.64	38.0	2.70	37.0	2.75
75	65	39.0	2.32	38.0	2.37	37.1	2.42	36.2	2.46	35.3	2.51	

**NOTE:** Specifications are based on the following conditions.

- Power source of specifications: 230 V
- 2 or more indoor units should be connected.
- Pipe length: 24.6 ft (7.5 m), Height difference: 0 ft (0 m) [Outdoor unit - Indoor unit]
- The total ability of connected a indoor unit is from 34,000 Btu up to 54,000 Btu.
- Input in the table are calculated based on the maximum indoor unit input combinations.



Indoor unit connect- ing capacity	Outdoor temperature		Indoor temperature									
			15.6 °CDB		18.3 °CDB		21.1 °CDB		23.9 °CDB		25.6 °CDB	
	kBtu/h	°CDB	°CWB	TC	IP	TC	IP	TC	IP	TC	IP	TC
46	-15.0	-16.1	9.70	4.70	9.47	4.80	9.20	4.90	9.01	5.00	8.78	5.10
	-10.0	-11.1	10.94	4.70	10.68	4.80	10.40	4.90	10.16	5.00	9.90	5.10
	-5.0	-7.2	12.18	4.70	11.89	4.80	11.60	4.90	11.31	5.00	11.02	5.10
	0.0	-2.2	14.19	4.70	13.85	4.80	13.50	4.90	13.18	5.00	12.84	5.10
	5.0	2.8	16.20	4.70	15.81	4.80	15.40	4.90	15.04	5.00	14.66	5.10
	8.3	6.1	16.61	4.24	16.22	4.32	15.80	4.41	15.43	4.50	15.03	4.59
	10.0	8.3	16.61	4.24	16.22	4.32	15.80	4.41	15.43	4.50	15.03	4.59
	15.0	10.0	16.61	3.95	16.22	4.03	15.80	4.11	15.43	4.19	15.03	4.27
45	20.0	15.0	15.85	3.42	15.48	3.49	15.10	3.56	14.72	3.63	14.34	3.70
	23.9	18.3	15.11	3.12	14.75	3.19	14.30	3.25	14.03	3.32	13.67	3.38
	-15.0	-16.1	9.70	4.70	9.47	4.80	9.20	4.90	9.01	5.00	8.78	5.10
	-10.0	-11.1	10.94	4.70	10.68	4.80	10.40	4.90	10.16	5.00	9.90	5.10
	-5.0	-7.2	12.18	4.70	11.89	4.80	11.60	4.90	11.31	5.00	11.02	5.10
	0.0	-2.2	14.19	4.70	13.85	4.80	13.50	4.90	13.18	5.00	12.84	5.10
	5.0	2.8	16.20	4.70	15.81	4.80	15.40	4.90	15.04	5.00	14.66	5.10
	8.3	6.1	16.61	4.24	16.22	4.32	15.80	4.41	15.43	4.50	15.03	4.59
44	10.0	8.3	16.61	4.24	16.22	4.32	15.80	4.41	15.43	4.50	15.03	4.59
	15.0	10.0	16.61	3.95	16.22	4.03	15.80	4.11	15.43	4.19	15.03	4.27
	20.0	15.0	15.85	3.42	15.48	3.49	15.10	3.56	14.72	3.63	14.34	3.70
	23.9	18.3	15.11	3.12	14.75	3.19	14.30	3.25	14.03	3.32	13.67	3.38
	-15.0	-16.1	9.49	4.60	9.26	4.69	9.00	4.79	8.81	4.89	8.58	4.98
	-10.0	-11.1	10.70	4.60	10.44	4.69	10.10	4.79	9.93	4.89	9.68	4.98
	-5.0	-7.2	11.91	4.60	11.62	4.69	11.30	4.79	11.06	4.89	10.77	4.98
	0.0	-2.2	13.87	4.60	13.54	4.69	13.20	4.79	12.88	4.89	12.55	4.98
43	5.0	2.8	15.84	4.60	15.46	4.69	15.00	4.79	14.71	4.89	14.33	4.98
	8.3	6.1	16.24	4.14	15.86	4.22	15.40	4.31	15.08	4.39	14.70	4.48
	10.0	8.3	16.24	4.14	15.86	4.22	15.40	4.31	15.08	4.39	14.70	4.48
	15.0	10.0	16.24	3.85	15.86	3.93	15.40	4.01	15.08	4.09	14.70	4.17
	20.0	15.0	15.50	3.34	15.13	3.41	14.70	3.48	14.39	3.55	14.02	3.61
	23.9	18.3	14.78	3.05	14.42	3.11	14.00	3.18	13.72	3.24	13.37	3.30
	-15.0	-16.1	9.27	4.48	9.05	4.58	8.80	4.67	8.61	4.76	8.39	4.86
	-10.0	-11.1	10.45	4.48	10.20	4.58	9.90	4.67	9.71	4.76	9.46	4.86
42	-5.0	-7.2	11.64	4.48	11.36	4.58	11.00	4.67	10.81	4.76	10.53	4.86
	0.0	-2.2	13.56	4.48	13.24	4.58	12.90	4.67	12.59	4.76	12.27	4.86
	5.0	2.8	15.48	4.48	15.11	4.58	14.70	4.67	14.37	4.76	14.01	4.86
	8.3	6.1	15.87	4.04	15.50	4.12	15.10	4.21	14.74	4.29	14.36	4.37
	10.0	8.3	15.87	4.04	15.50	4.12	15.10	4.21	14.74	4.29	14.36	4.37
	15.0	10.0	15.87	3.76	15.50	3.84	15.10	3.92	14.74	4.00	14.36	4.07
	20.0	15.0	15.15	3.26	14.79	3.32	14.40	3.39	14.07	3.46	13.71	3.53
	23.9	18.3	14.44	2.98	14.10	3.04	13.70	3.10	13.41	3.16	13.06	3.22
41	-15.0	-16.1	9.05	4.38	8.84	4.47	8.60	4.56	8.41	4.65	8.19	4.74
	-10.0	-11.1	10.21	4.38	9.97	4.47	9.70	4.56	9.48	4.65	9.24	4.74
	-5.0	-7.2	11.37	4.38	11.10	4.47	10.80	4.56	10.55	4.65	10.28	4.74
	0.0	-2.2	13.24	4.38	12.93	4.47	12.60	4.56	12.30	4.65	11.98	4.74
	5.0	2.8	15.12	4.38	14.76	4.47	14.40	4.56	14.04	4.65	13.68	4.74
	8.3	6.1	15.50	3.94	15.14	4.02	14.70	4.10	14.40	4.18	14.03	4.27
	10.0	8.3	15.50	3.94	15.14	4.02	14.70	4.10	14.40	4.18	14.03	4.27
	15.0	10.0	15.50	3.67	15.14	3.74	14.70	3.82	14.40	3.90	14.03	3.97
40	20.0	15.0	14.80	3.18	14.44	3.24	14.00	3.31	13.74	3.37	13.39	3.44
	23.9	18.3	14.10	2.90	13.77	2.96	13.40	3.02	13.10	3.08	12.76	3.15
	-15.0	-16.1	8.84	4.26	8.63	4.35	8.40	4.44	8.21	4.53	8.00	4.62
	-10.0	-11.1	9.97	4.26	9.73	4.35	9.40	4.44	9.25	4.53	9.02	4.62
	-5.0	-7.2	11.10	4.26	10.83	4.35	10.50	4.44	10.30	4.53	10.04	4.62
	0.0	-2.2	12.93	4.26	12.62	4.35	12.30	4.44	12.00	4.53	11.70	4.62
	5.0	2.8	14.76	4.26	14.41	4.35	14.00	4.44	13.71	4.53	13.35	4.62
	8.3	6.1	15.14	3.84	14.78	3.92	14.40	4.00	14.05	4.08	13.69	4.16
39	10.0	8.3	15.14	3.84	14.78	3.92	14.40	4.00	14.05	4.08	13.69	4.16
	15.0	10.0	15.14	3.58	14.78	3.65	14.40	3.72	14.05	3.80	13.69	3.87
	20.0	15.0	14.44	3.10	14.10	3.16	13.70	3.23	13.41	3.29	13.07	3.35
	23.9	18.3	13.77	2.83	13.44	2.89	13.10	2.95	12.78	3.01	12.46	3.07
	-15.0	-16.1	8.62	4.16	8.42	4.24	8.20	4.33	8.01	4.42	7.80	4.50
	-10.0	-11.1	9.72	4.16	9.49	4.24	9.20	4.33	9.03	4.42	8.80	4.50
	-5.0	-7.2	10.82	4.16	10.57	4.24	10.30	4.33	10.05	4.42	9.79	4.50
	0.0	-2.2	12.61	4.16	12.31	4.24	12.00	4.33	11.71	4.42	11.41	4.50
38	5.0	2.8	14.40	4.16	14.06	4.24	13.70	4.33	13.37	4.42	13.03	4.50
	8.3	6.1	14.77	3.74	14.41	3.82	14.00	3.89	13.71	3.97	13.36	4.05
	10.0	8.3	14.77	3.74	14.41	3.82	14.00	3.89	13.71	3.97	13.36	4.05
	15.0	10.0	14.77	3.48	14.41	3.56	14.00	3.63	13.71	3.70	13.36	3.77
	20.0	15.0	14.09	3.02	13.76	3.08	13.40	3.14	13.09	3.20	12.75	3.27
	23.9	18.3	13.43	2.76	13.11	2.81	12.70	2.87	12.47	2.93	12.15	2.99
	-15.0	-16.1	8.41	4.05	8.21	4.14	8.00	4.22	7.81	4.30	7.61	4.39
	-10.0	-11.1	9.48	4.05	9.25	4.14	9.00	4.22	8.80	4.30	8.58	4.39
37	-5.0	-7.2	10.55	4.05	10.30	4.14	10.00	4.22	9.80	4.30	9.55	4.39
	0.0	-2.2	12.30	4.05	12.00	4.14	11.70	4.22	11.42	4.30	11.12	4.39
	5.0	2.8	14.04	4.05	13.71	4.14	13.30	4.22	13.04	4.30	12.70	4.39
	8.3	6.1	14.40	3.64	14.05	3.72	13.70	3.79	13.37	3.87	13.03	3.94
	10.0	8.3	14.40	3.64	14.05	3.72	13.70	3.79	13.37	3.87	13.03	3.94
	15.0	10.0	14.40	3.39	14.05	3.46	13.70	3.53	13.37	3.60	13.03	3.67
	20.0	15.0	13.74	2.94	13.41	3.00	13.00	3.06	12.76	3.12	12.43	3.18
	23.9	18.3	13.10	2.68	12.78	2.74	12.40	2.80	12.16	2.85	11.85	2.91
36	-15.0	-16.1	8.19	3.93	8.00	4.01	7.80	4.10	7.61	4.18	7.41	4.26
	-10.0	-11.1	9.24	3.93	9.02	4.01	8.80	4.10	8.58	4.18	8.36	4.26
	-5.0	-7.2	10.28	3.93	10.04	4.01	9.70	4.10	9.55	4.18	9.30	4.26
	0.0	-2.2	11.98	3.93	11.70	4.01	11.40	4.10	11.12	4.18	10.84	4.26
	5.0	2.8	13.68	3.93	13.35	4.01	13.00	4.10	12.70	4.18	12.38	4.26
	8.3	6.1	14.03	3.54	13.69	3.61	13.30	3.69	13.03	3.76	12.69	3.84
	10.0	8.3	14.03	3.54	13.69	3.61	13.30	3.69	13.03	3.76	12.69	3.84
	15.0	10.0	14.03	3.30	13.69	3.37	13.30	3.44	13.03	3.50	12.69	3.57
35	20.0	15.0	13.39	2.86	13.07	2.92	12.70	2.97	12.43	3.03	12.11	3.09
	23.9	18.3	12.76	2.61	12.46	2.66	12.10	2.72	11.85	2.77	11.54	2.83

OUTDOOR UNIT  
ROMH45AFXJ

Indoor unit connect- ing capacity	Outdoor temperature		Indoor temperature									
			15.6 °CDB		18.3 °CDB		21.1 °CDB		23.9 °CDB		25.6 °CDB	
	kBtu/h	°CDB	°CWB	TC	IP	TC	IP	TC	IP	TC	IP	TC
37	-15.0	-16.1	7.98	3.83	7.79	3.91	7.60	3.99	7.41	4.07	7.22	4.15
	-10.0	-11.1	8.99	3.83	8.78	3.91	8.50	3.99	8.35	4.07	8.14	4.15
	-5.0	-7.2	10.01	3.83	9.77	3.91	9.50	3.99	9.30	4.07	9.06	4.15
	0.0	-2.2	11.67	3.83	11.39	3.91	11.10	3.99	10.83	4.07	10.55	4.15
	5.0	2.8	13.32	3.83	13.00	3.91	12.60	3.99	12.37	4.07	12.05	4.15
	8.3	6.1	13.66	3.44	13.33	3.51	13.00	3.58	12.68	3.66	12.36	3.73
	10.0	8.3	13.66	3.44	13.33	3.51	13.00	3.58	12.68	3.66	12.36	3.73
	15.0	10.0	13.66	3.21	13.33	3.27	13.00	3.34	12.68	3.41	12.36	3.47
	20.0	15.0	13.03	2.78	12.72	2.83	12.40	2.89	12.10	2.95	11.79	3.01
23.9	18.3	12.42	2.54	12.13	2.59	11.80	2.64	11.54	2.70	11.24	2.75	
36	-15.0	-16.1	7.76	3.72	7.58	3.79	7.30	3.87	7.21	3.95	7.02	4.02
	-10.0	-11.1	8.75	3.72	8.54	3.79	8.30	3.87	8.13	3.95	7.92	4.02
	-5.0	-7.2	9.74	3.72	9.51	3.79	9.20	3.87	9.05	3.95	8.81	4.02
	0.0	-2.2	11.35	3.72	11.08	3.79	10.80	3.87	10.54	3.95	10.27	4.02
	5.0	2.8	12.96	3.72	12.65	3.79	12.30	3.87	12.03	3.95	11.72	4.02
	8.3	6.1	13.29	3.34	12.97	3.41	12.60	3.48	12.34	3.55	12.02	3.62
	10.0	8.3	13.29	3.34	12.97	3.41	12.60	3.48	12.34	3.55	12.02	3.62
	15.0	10.0	13.29	3.11	12.97	3.18	12.60	3.24	12.34	3.31	12.02	3.37
	20.0	15.0	12.68	2.70	12.38	2.75	12.00	2.81	11.78	2.86	11.47	2.92
23.9	18.3	12.09	2.46	11.80	2.52	11.50	2.57	11.22	2.62	10.94	2.67	
35	-15.0	-16.1	7.54	3.60	7.36	3.68	7.10	3.75	7.01	3.83	6.83	3.90
	-10.0	-11.1	8.51	3.60	8.30	3.68	8.10	3.75	7.90	3.83	7.70	3.90
	-5.0	-7.2	9.47	3.60	9.25	3.68	9.00	3.75	8.79	3.83	8.57	3.90
	0.0	-2.2	11.03	3.60	10.77	3.68	10.50	3.75	10.25	3.83	9.98	3.90
	5.0	2.8	12.60	3.60	12.30	3.68	12.00	3.75	11.70	3.83	11.40	3.90
	8.3	6.1	12.92	3.24	12.61	3.31	12.30	3.38	12.00	3.44	11.69	3.51
	10.0	8.3	12.92	3.24	12.61	3.31	12.30	3.38	12.00	3.44	11.69	3.51
	15.0	10.0	12.92	3.02	12.61	3.08	12.30	3.15	12.00	3.21	11.69	3.27
	20.0	15.0	12.33	2.62	12.04	2.67	11.70	2.72	11.45	2.78	11.16	2.83
23.9	18.3	11.75	2.39	11.47	2.44	11.10	2.49	10.91	2.54	10.63	2.59	
34	-15.0	-16.1	7.33	3.49	7.15	3.57	6.90	3.64	6.80	3.71	6.63	3.79
	-10.0	-11.1	8.26	3.49	8.07	3.57	7.80	3.64	7.67	3.71	7.48	3.79
	-5.0	-7.2	9.20	3.49	8.98	3.57	8.70	3.64	8.54	3.71	8.32	3.79
	0.0	-2.2	10.72	3.49	10.46	3.57	10.20	3.64	9.95	3.71	9.70	3.79
	5.0	2.8	12.24	3.49	11.95	3.57	11.60	3.64	11.36	3.71	11.07	3.79
	8.3	6.1	12.55	3.15	12.25	3.21	11.90	3.28	11.65	3.34	11.35	3.41
	10.0	8.3	12.55	3.15	12.25	3.21	11.90	3.28	11.65	3.34	11.35	3.41
	15.0	10.0	12.55	2.93	12.25	2.99	11.90	3.05	11.65	3.11	11.35	3.17
	20.0	15.0	11.98	2.54	11.69	2.59	11.40	2.64	11.12	2.70	10.84	2.75
23.9	18.3	11.42	2.32	11.14	2.37	10.80	2.42	10.60	2.46	10.33	2.51	

**NOTE:** Specifications are based on the following conditions.

- Power source of specifications: 230 V
- 2 or more indoor units should be connected.
- Pipe length: 24.6 ft (7.5 m), Height difference: 0 ft (0 m) [Outdoor unit - Indoor unit]
- The total ability of connected a indoor unit is from 34,000 Btu up to 54,000 Btu.
- Input in the table are calculated based on the maximum indoor unit input combinations.

## ■ Wall mounted type

### ● Heating capacity in kBtu/h

- TC: Total Capacity (kBtu/h).
- The data is based on the following conditions:  
Pipe length: 24.6 ft (7.5 m), Height difference: 0 ft (0 m) [Outdoor unit - Indoor unit]

#### MODEL: RIWH07AVFJ

Outdoor temperature		Indoor temperature (°FDB)				
(°FDB)	(°FWB)	60.0	65.0	70.0	75.0	78.0
		TC	TC	TC	TC	TC
5.0	3.0	5.15	5.03	4.91	4.78	4.66
14.0	12.0	5.81	5.67	5.53	5.39	5.26
23.0	19.0	6.47	6.31	6.16	6.00	5.85
32.0	28.0	7.53	7.35	7.17	7.00	6.82
41.0	37.0	8.60	8.40	8.19	7.99	7.78
47.0	43.0	8.82	8.61	8.40	8.19	7.98
50.0	47.0	8.82	8.61	8.40	8.19	7.98
59.0	50.0	8.82	8.61	8.40	8.19	7.98
68.0	59.0	8.42	8.22	8.02	7.82	7.62
75.0	65.0	8.02	7.83	7.64	7.45	7.26

#### MODEL: RIWH09AVFJ

Outdoor temperature		Indoor temperature (°FDB)				
(°FDB)	(°FWB)	60.0	65.0	70.0	75.0	78.0
		TC	TC	TC	TC	TC
5.0	3.0	6.62	6.47	6.31	6.15	5.99
14.0	12.0	7.47	7.29	7.11	6.94	6.76
23.0	19.0	8.31	8.12	7.92	7.72	7.52
32.0	28.0	9.69	9.46	9.22	8.99	8.76
41.0	37.0	11.06	10.80	10.53	10.27	10.01
47.0	43.0	11.34	11.07	10.80	10.53	10.26
50.0	47.0	11.34	11.07	10.80	10.53	10.26
59.0	50.0	11.34	11.07	10.80	10.53	10.26
68.0	59.0	10.82	10.56	10.31	10.05	9.79
75.0	65.0	10.32	10.07	9.82	9.58	9.33

#### MODEL: RIWH12AVFJ

Outdoor temperature		Indoor temperature (°FDB)				
(°FDB)	(°FWB)	60.0	65.0	70.0	75.0	78.0
		TC	TC	TC	TC	TC
5.0	3.0	8.83	8.62	8.41	8.20	7.99
14.0	12.0	9.96	9.72	9.48	9.25	9.01
23.0	19.0	11.08	10.82	10.56	10.29	10.03
32.0	28.0	12.91	12.61	12.30	11.99	11.68
41.0	37.0	14.74	14.39	14.04	13.69	13.34
47.0	43.0	15.12	14.76	14.40	14.04	13.68
50.0	47.0	15.12	14.76	14.40	14.04	13.68
59.0	50.0	15.12	14.76	14.40	14.04	13.68
68.0	59.0	14.43	14.09	13.74	13.40	13.06
75.0	65.0	13.75	13.43	13.10	12.77	12.44

**MODEL: RIWH15AVFJ**

Outdoor temperature		Indoor temperature (°FDB)				
		60.0	65.0	70.0	75.0	78.0
(°FDB)	(°FWB)	TC	TC	TC	TC	TC
5.0	3.0	11.04	10.78	10.51	10.25	9.99
14.0	12.0	12.45	12.15	11.85	11.56	11.26
23.0	19.0	13.86	13.53	13.20	12.87	12.54
32.0	28.0	16.14	15.76	15.37	14.99	14.61
41.0	37.0	18.43	17.99	17.55	17.11	16.68
47.0	43.0	18.90	18.45	18.00	17.55	17.10
50.0	47.0	18.90	18.45	18.00	17.55	17.10
59.0	50.0	18.90	18.45	18.00	17.55	17.10
68.0	59.0	18.04	17.61	17.18	16.75	16.32
75.0	65.0	17.19	16.78	16.37	15.96	15.55

**MODEL: RIWH18AVFJ**

Outdoor temperature		Indoor temperature (°FDB)				
		60.0	65.0	70.0	75.0	78.0
(°FDB)	(°FWB)	TC	TC	TC	TC	TC
5.0	3.0	13.25	12.93	12.62	12.30	11.99
14.0	12.0	14.94	14.58	14.23	13.87	13.51
23.0	19.0	16.63	16.23	15.84	15.44	15.04
32.0	28.0	19.37	18.91	18.45	17.99	17.53
41.0	37.0	22.12	21.59	21.06	20.54	20.01
47.0	43.0	22.68	22.14	21.60	21.06	20.52
50.0	47.0	22.68	22.14	21.60	21.06	20.52
59.0	50.0	22.68	22.14	21.60	21.06	20.52
68.0	59.0	21.64	21.13	20.61	20.10	19.58
75.0	65.0	20.63	20.14	19.65	19.16	18.67

**MODEL: RIWH24AVFJ**

Outdoor temperature		Indoor temperature (°FDB)				
		60.0	65.0	70.0	75.0	78.0
(°FDB)	(°FWB)	TC	TC	TC	TC	TC
5.0	3.0	17.66	17.24	16.82	16.40	15.98
14.0	12.0	19.92	19.44	18.97	18.49	18.02
23.0	19.0	22.17	21.64	21.11	20.59	20.06
32.0	28.0	25.83	25.21	24.60	23.98	23.37
41.0	37.0	29.49	28.79	28.08	27.38	26.68
47.0	43.0	30.24	29.52	28.80	28.08	27.36
50.0	47.0	30.24	29.52	28.80	28.08	27.36
59.0	50.0	30.24	29.52	28.80	28.08	27.36
68.0	59.0	28.86	28.17	27.49	26.80	26.11
75.0	65.0	27.51	26.85	26.20	25.54	24.89

## ● Heating capacity in kW

- TC: Total Capacity (kW).
- The data is based on the following conditions:  
Pipe length: 24.6 ft (7.5 m), Height difference: 0 ft (0 m) [Outdoor unit - Indoor unit]

### MODEL: RIWH07AVFJ

Outdoor temperature		Indoor temperature (°CDB)				
		15.6	18.3	21.1	23.9	25.6
(°CDB)	(°CWB)	TC	TC	TC	TC	TC
-15.0	-16.1	1.51	1.47	1.44	1.40	1.37
-10.0	-11.1	1.70	1.66	1.62	1.58	1.54
-5.0	-7.2	1.90	1.85	1.80	1.76	1.71
0.0	-2.2	2.21	2.16	2.10	2.05	2.00
5.0	2.8	2.52	2.46	2.40	2.34	2.28
8.3	6.1	2.58	2.52	2.46	2.40	2.34
10.0	8.3	2.58	2.52	2.46	2.40	2.34
15.0	10.0	2.58	2.52	2.46	2.40	2.34
20.0	15.0	2.47	2.41	2.35	2.29	2.23
23.9	18.3	2.35	2.30	2.24	2.18	2.13

### MODEL: RIWH09AVFJ

Outdoor temperature		Indoor temperature (°CDB)				
		15.6	18.3	21.1	23.9	25.6
(°CDB)	(°CWB)	TC	TC	TC	TC	TC
-15.0	-16.1	1.94	1.90	1.85	1.80	1.76
-10.0	-11.1	2.19	2.14	2.08	2.03	1.98
-5.0	-7.2	2.44	2.38	2.32	2.26	2.20
0.0	-2.2	2.84	2.77	2.70	2.64	2.57
5.0	2.8	3.24	3.16	3.09	3.01	2.93
8.3	6.1	3.32	3.24	3.17	3.09	3.01
10.0	8.3	3.32	3.24	3.17	3.09	3.01
15.0	10.0	3.32	3.24	3.17	3.09	3.01
20.0	15.0	3.17	3.10	3.02	2.95	2.87
23.9	18.3	3.02	2.95	2.88	2.81	2.74

### MODEL: RIWH12AVFJ

Outdoor temperature		Indoor temperature (°CDB)				
		15.6	18.3	21.1	23.9	25.6
(°CDB)	(°CWB)	TC	TC	TC	TC	TC
-15.0	-16.1	2.59	2.53	2.47	2.40	2.34
-10.0	-11.1	2.92	2.85	2.78	2.71	2.64
-5.0	-7.2	3.25	3.17	3.09	3.02	2.94
0.0	-2.2	3.79	3.69	3.60	3.51	3.42
5.0	2.8	4.32	4.22	4.12	4.01	3.91
8.3	6.1	4.43	4.33	4.22	4.11	4.01
10.0	8.3	4.43	4.33	4.22	4.11	4.01
15.0	10.0	4.43	4.33	4.22	4.11	4.01
20.0	15.0	4.23	4.13	4.03	3.93	3.83
23.9	18.3	4.03	3.94	3.84	3.74	3.65

**MODEL: RIWH15AVFJ**

Outdoor temperature		Indoor temperature (°CDB)				
		15.6	18.3	21.1	23.9	25.6
(°CDB)	(°CWB)	TC	TC	TC	TC	TC
-15.0	-16.1	3.24	3.16	3.08	3.00	2.93
-10.0	-11.1	3.65	3.56	3.47	3.39	3.30
-5.0	-7.2	4.06	3.96	3.87	3.77	3.67
0.0	-2.2	4.73	4.62	4.51	4.39	4.28
5.0	2.8	5.40	5.27	5.14	5.02	4.89
8.3	6.1	5.54	5.41	5.28	5.14	5.01
10.0	8.3	5.54	5.41	5.28	5.14	5.01
15.0	10.0	5.54	5.41	5.28	5.14	5.01
20.0	15.0	5.29	5.16	5.03	4.91	4.78
23.9	18.3	5.04	4.92	4.80	4.68	4.56

**MODEL: RIWH18AVFJ**

Outdoor temperature		Indoor temperature (°CDB)				
		15.6	18.3	21.1	23.9	25.6
(°CDB)	(°CWB)	TC	TC	TC	TC	TC
-15.0	-16.1	3.88	3.79	3.70	3.61	3.51
-10.0	-11.1	4.38	4.27	4.17	4.07	3.96
-5.0	-7.2	4.87	4.76	4.64	4.53	4.41
0.0	-2.2	5.68	5.54	5.41	5.27	5.14
5.0	2.8	6.48	6.33	6.17	6.02	5.86
8.3	6.1	6.65	6.49	6.33	6.17	6.01
10.0	8.3	6.65	6.49	6.33	6.17	6.01
15.0	10.0	6.65	6.49	6.33	6.17	6.01
20.0	15.0	6.34	6.19	6.04	5.89	5.74
23.9	18.3	6.05	5.90	5.76	5.61	5.47

**MODEL: RIWH24AVFJ**

Outdoor temperature		Indoor temperature (°CDB)				
		15.6	18.3	21.1	23.9	25.6
(°CDB)	(°CWB)	TC	TC	TC	TC	TC
-15.0	-16.1	5.18	5.05	4.93	4.81	4.68
-10.0	-11.1	5.84	5.70	5.56	5.42	5.28
-5.0	-7.2	6.50	6.34	6.19	6.03	5.88
0.0	-2.2	7.57	7.39	7.21	7.03	6.85
5.0	2.8	8.64	8.44	8.23	8.03	7.82
8.3	6.1	8.86	8.65	8.44	8.23	8.02
10.0	8.3	8.86	8.65	8.44	8.23	8.02
15.0	10.0	8.86	8.65	8.44	8.23	8.02
20.0	15.0	8.46	8.26	8.06	7.85	7.65
23.9	18.3	8.06	7.87	7.68	7.49	7.29



## 7. Capacity compensation rate for pipe length and height difference

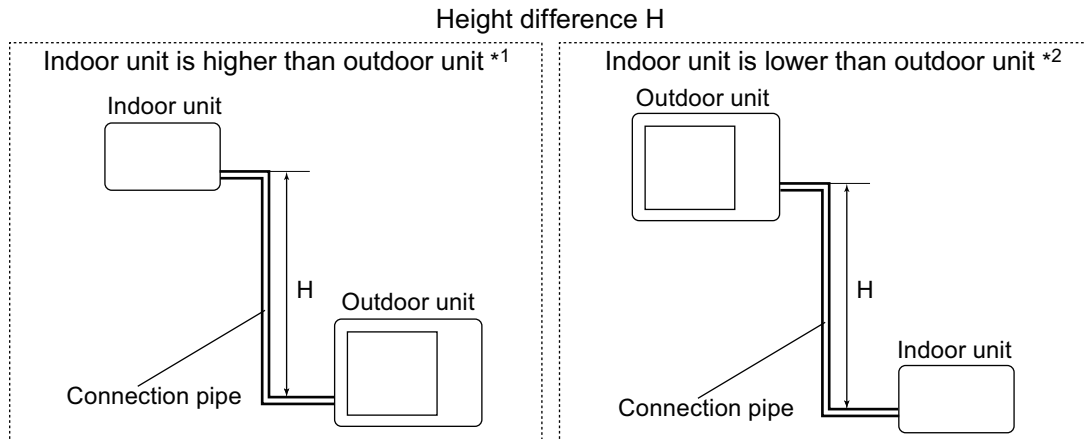

### 7-1. Model: ROMH45AFXZJ

**NOTE:** Values mentioned in the table are calculated based on the maximum capacity.

#### ■ Indoor unit: 7,000 Btu

COOLING		Pipe length							
		m	ft	5	7.5	10	15	20	25
Height difference H (m)	Indoor unit is higher than outdoor unit *1	15	49	—	—	—	0.955	0.941	0.927
		10	33	—	—	0.976	0.962	0.949	0.935
		7.5	25	—	0.988	0.980	0.966	0.952	0.939
		5	16	0.995	0.992	0.984	0.970	0.956	0.942
	Indoor unit is lower than outdoor unit *2	0	0	1.003	1.000	0.992	0.978	0.964	0.950
		-5	-16	1.003	1.000	0.992	0.978	0.964	0.950
		-7.5	-25	—	1.000	0.992	0.978	0.964	0.950
		-10	-33	—	—	0.992	0.978	0.964	0.950
		-15	-49	—	—	—	0.978	0.964	0.950

HEATING		Pipe length							
		m	ft	5	7.5	10	15	20	25
Height difference H (m)	Indoor unit is higher than outdoor unit *1	15	49	—	—	—	0.976	0.957	0.938
		10	33	—	—	0.991	0.976	0.957	0.938
		7.5	25	—	1.000	0.991	0.976	0.957	0.938
		5	16	0.990	1.000	0.991	0.976	0.957	0.938
	Indoor unit is lower than outdoor unit *2	0	0	0.990	1.000	0.991	0.976	0.957	0.938
		-5	-16	0.985	0.995	0.986	0.971	0.952	0.933
		-7.5	-25	—	0.993	0.984	0.969	0.950	0.931
		-10	-33	—	—	0.981	0.966	0.947	0.929
		-15	-49	—	—	—	0.961	0.943	0.924

## Indoor unit: 9,000 Btu

OUTDOOR UNIT  
ROMH45AFXZJ

COOLING		Pipe length							
			m	5	7.5	10	15	20	25
		m	ft	16	25	33	49	66	82
Height difference H (m)	Indoor unit is higher than outdoor unit *1	15	49	—	—	—	0.956	0.942	0.928
		10	33	—	—	0.977	0.963	0.950	0.936
		7.5	25	—	0.988	0.981	0.967	0.954	0.940
		5	16	0.999	0.992	0.985	0.971	0.957	0.943
	0	0	1.007	1.000	0.993	0.979	0.965	0.951	
Indoor unit is lower than outdoor unit *2	-5	-16	1.007	1.000	0.993	0.979	0.965	0.951	
	-7.5	-25	—	1.000	0.993	0.979	0.965	0.951	
	-10	-33	—	—	0.993	0.979	0.965	0.951	
	-15	-49	—	—	—	0.979	0.965	0.951	

HEATING		Pipe length							
			m	5	7.5	10	15	20	25
		m	ft	16	25	33	49	66	82
Height difference H (m)	Indoor unit is higher than outdoor unit *1	15	49	—	—	—	0.977	0.958	0.939
		10	33	—	—	0.993	0.977	0.958	0.939
		7.5	25	—	1.000	0.993	0.977	0.958	0.939
		5	16	0.993	1.000	0.993	0.977	0.958	0.939
	0	0	0.993	1.000	0.993	0.977	0.958	0.939	
Indoor unit is lower than outdoor unit *2	-5	-16	0.988	0.995	0.988	0.972	0.954	0.934	
	-7.5	-25	—	0.993	0.986	0.970	0.952	0.932	
	-10	-33	—	—	0.983	0.967	0.949	0.930	
	-15	-49	—	—	—	0.962	0.944	0.925	

## Indoor unit: 12,000 Btu

COOLING		Pipe length							
			m	5	7.5	10	15	20	25
		m	ft	16	25	33	49	66	82
Height difference H (m)	Indoor unit is higher than outdoor unit *1	15	49	—	—	—	0.937	0.912	0.888
		10	33	—	—	0.970	0.944	0.919	0.896
		7.5	25	—	0.988	0.974	0.948	0.923	0.899
		5	16	1.006	0.992	0.978	0.952	0.927	0.903
	0	0	1.014	1.000	0.986	0.960	0.934	0.910	
Indoor unit is lower than outdoor unit *2	-5	-16	1.014	1.000	0.986	0.960	0.934	0.910	
	-7.5	-25	—	1.000	0.986	0.960	0.934	0.910	
	-10	-33	—	—	0.986	0.960	0.934	0.910	
	-15	-49	—	—	—	0.960	0.934	0.910	

HEATING		Pipe length							
			m	5	7.5	10	15	20	25
		m	ft	16	25	33	49	66	82
Height difference H (m)	Indoor unit is higher than outdoor unit *1	15	49	—	—	—	0.977	0.958	0.938
		10	33	—	—	0.993	0.977	0.958	0.938
		7.5	25	—	1.000	0.993	0.977	0.958	0.938
		5	16	0.995	1.000	0.993	0.977	0.958	0.938
	0	0	0.995	1.000	0.993	0.977	0.958	0.938	
Indoor unit is lower than outdoor unit *2	-5	-16	0.990	0.995	0.988	0.972	0.953	0.933	
	-7.5	-25	—	0.993	0.986	0.970	0.952	0.932	
	-10	-33	—	—	0.983	0.967	0.949	0.929	
	-15	-49	—	—	—	0.962	0.944	0.924	

## ■ Indoor unit: 14,000 Btu

COOLING		Pipe length							
			m	5	7.5	10	15	20	25
		m	ft	16	25	33	49	66	82
Height difference H (m)	Indoor unit is higher than outdoor unit *1	15	49	—	—	—	0.955	0.937	0.922
		10	33	—	—	0.974	0.962	0.945	0.930
		7.5	25	—	0.988	0.978	0.966	0.948	0.934
		5	16	0.997	0.992	0.982	0.970	0.952	0.937
		0	0	1.005	1.000	0.990	0.978	0.960	0.945
Height difference H (m)	Indoor unit is lower than outdoor unit *2	-5	-16	1.005	1.000	0.990	0.978	0.960	0.945
		-7.5	-25	—	1.000	0.990	0.978	0.960	0.945
		-10	-33	—	—	0.990	0.978	0.960	0.945
		-15	-49	—	—	—	0.978	0.960	0.945

HEATING		Pipe length							
			m	5	7.5	10	15	20	25
		m	ft	16	25	33	49	66	82
Height difference H (m)	Indoor unit is higher than outdoor unit *1	15	49	—	—	—	0.972	0.945	0.919
		10	33	—	—	0.992	0.972	0.945	0.919
		7.5	25	—	1.000	0.992	0.972	0.945	0.919
		5	16	1.000	1.000	0.992	0.972	0.945	0.919
		0	0	1.000	1.000	0.992	0.972	0.945	0.919
Height difference H (m)	Indoor unit is lower than outdoor unit *2	-5	-16	0.995	0.995	0.987	0.967	0.940	0.914
		-7.5	-25	—	0.993	0.985	0.965	0.938	0.912
		-10	-33	—	—	0.982	0.962	0.935	0.910
		-15	-49	—	—	—	0.957	0.930	0.905

## ■ Indoor unit: 18,000 Btu

COOLING		Pipe length							
			m	5	7.5	10	15	20	25
		m	ft	16	25	33	49	66	82
Height difference H (m)	Indoor unit is higher than outdoor unit *1	15	49	—	—	—	0.968	0.961	0.954
		10	33	—	—	0.982	0.976	0.969	0.962
		7.5	25	—	0.988	0.986	0.980	0.973	0.966
		5	16	0.994	0.992	0.990	0.984	0.977	0.970
		0	0	1.002	1.000	0.998	0.992	0.985	0.978
Height difference H (m)	Indoor unit is lower than outdoor unit *2	-5	-16	1.002	1.000	0.998	0.992	0.985	0.978
		-7.5	-25	—	1.000	0.998	0.992	0.985	0.978
		-10	-33	—	—	0.998	0.992	0.985	0.978
		-15	-49	—	—	—	0.992	0.985	0.978

HEATING		Pipe length							
			m	5	7.5	10	15	20	25
		m	ft	16	25	33	49	66	82
Height difference H (m)	Indoor unit is higher than outdoor unit *1	15	49	—	—	—	0.967	0.943	0.917
		10	33	—	—	0.990	0.967	0.943	0.917
		7.5	25	—	1.000	0.990	0.967	0.943	0.917
		5	16	1.010	1.000	0.990	0.967	0.943	0.917
		0	0	1.010	1.000	0.990	0.967	0.943	0.917
Height difference H (m)	Indoor unit is lower than outdoor unit *2	-5	-16	1.005	0.995	0.985	0.962	0.938	0.912
		-7.5	-25	—	0.993	0.983	0.960	0.936	0.910
		-10	-33	—	—	0.980	0.958	0.933	0.908
		-15	-49	—	—	—	0.953	0.929	0.903

## Indoor unit: 24,000 Btu

OUTDOOR UNIT  
ROMH45AFXJ

COOLING		Pipe length							
			m	5	7.5	10	15	20	25
		m	ft	16	25	33	49	66	82
Height difference H (m)	Indoor unit is higher than outdoor unit *1	15	49	—	—	—	0.978	0.969	0.953
		10	33	—	—	0.986	0.986	0.977	0.961
		7.5	25	—	0.988	0.990	0.990	0.981	0.965
		5	16	0.989	0.992	0.994	0.994	0.984	0.968
		0	0	0.997	1.000	1.002	1.002	0.992	0.976
	Indoor unit is lower than outdoor unit *2	-5	-16	0.997	1.000	1.002	1.002	0.992	0.976
		-7.5	-25	—	1.000	1.002	1.002	0.992	0.976
		-10	-33	—	—	1.002	1.002	0.992	0.976
-15		-49	—	—	—	1.002	0.992	0.976	

HEATING		Pipe length							
			m	5	7.5	10	15	20	25
		m	ft	16	25	33	49	66	82
Height difference H (m)	Indoor unit is higher than outdoor unit *1	15	49	—	—	—	0.964	0.939	0.913
		10	33	—	—	0.988	0.964	0.939	0.913
		7.5	25	—	1.000	0.988	0.964	0.939	0.913
		5	16	1.008	1.000	0.988	0.964	0.939	0.913
		0	0	1.008	1.000	0.988	0.964	0.939	0.913
	Indoor unit is lower than outdoor unit *2	-5	-16	1.003	0.995	0.983	0.959	0.934	0.909
		-7.5	-25	—	0.993	0.981	0.957	0.932	0.907
		-10	-33	—	—	0.978	0.954	0.929	0.904
-15		-49	—	—	—	0.949	0.925	0.899	

## 8. Additional charge calculation

### 8-1. Model: ROMH45AFXZJ

Refrigerant type	R410A	
Refrigerant amount	lb oz	8 lb 13 oz
	g	4,000

#### ■ Refrigerant charge

Total pipe length	ft (m)	164 (50) or less	197 (60)	230 (70)	262 (80) (Max.)	0.22 oz/ft (20 g/m)
Additional charge	lb oz (g)	0	7.1 oz (200)	14.1 oz (400)	21.2 oz (600)	

---

## 9. Airflow

---

### 9-1. Model: ROMH45AFXZJ

#### ● Cooling

m <sup>3</sup> /h	4,200
l/s	1,167
CFM	2,472

#### ● Heating

m <sup>3</sup> /h	4,200
l/s	1,167
CFM	2,472

# 10. Operation noise (sound pressure)

## 10-1. Noise level curve

■ Model: ROMH45AFXZJ

● Cooling

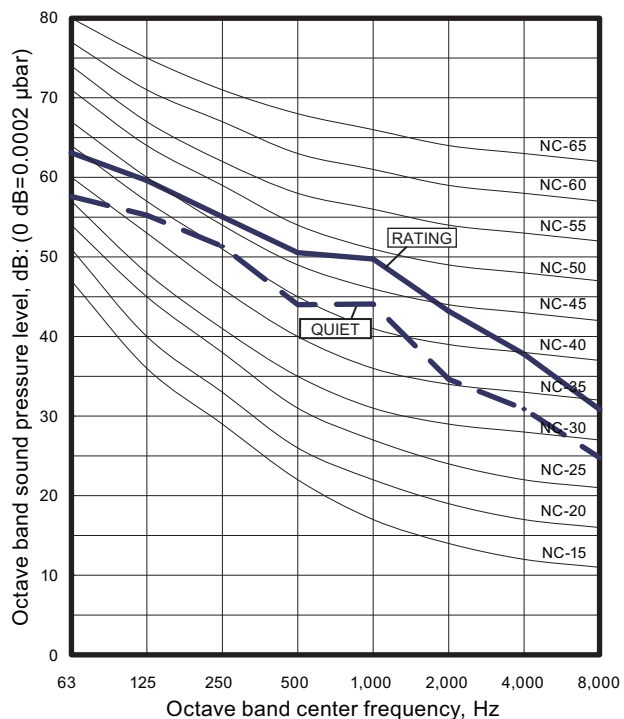

● Heating

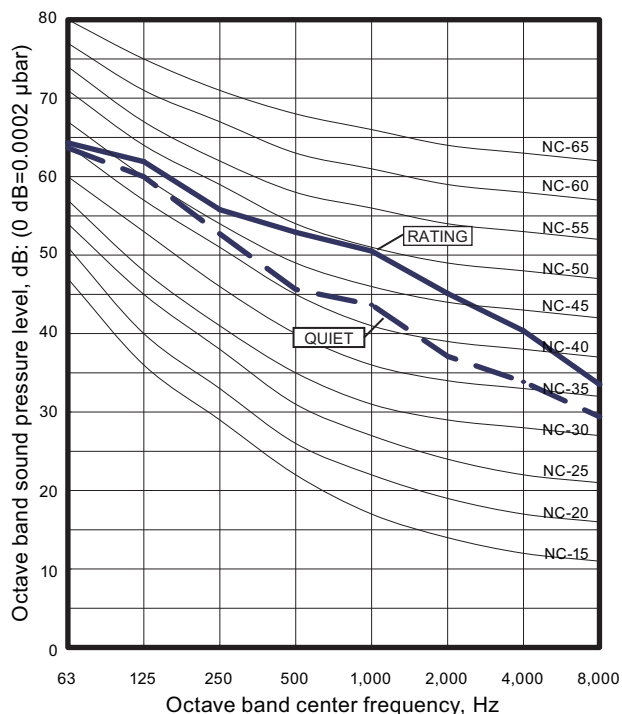

## 10-2. Sound level check point

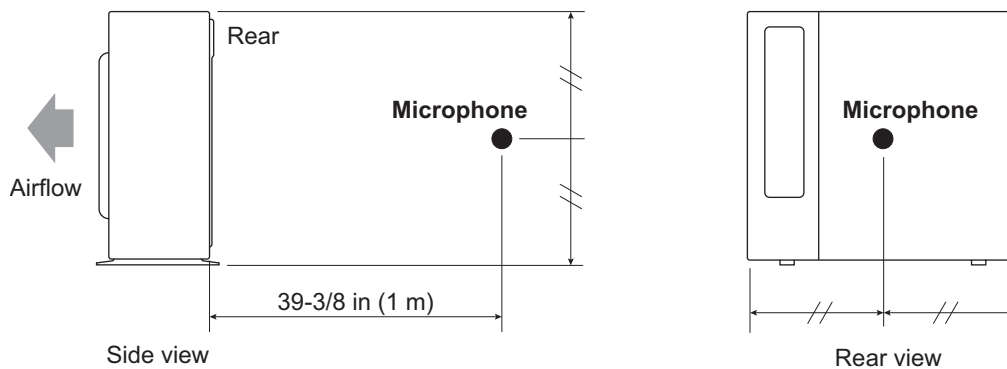

**NOTE:** Detailed shape of the actual outdoor unit might be slightly different from the one illustrated above.

OUTDOOR UNIT  
ROMH45AFXZJ

## 11. Electrical characteristics

Model name			ROMH45AFXZJ
Power supply	Voltage	V	208/230 ~
	Frequency	Hz	60
MCA		A	28.9
Starting current		A	20.1
Wiring spec. *	CKT. BKR	A	30
	Power cable	AWG	10

\*: Selected sample based on Japan Electrotechnical Standards and Codes Committee E0005. As the regulations of wire size and circuit breaker differ in each country or region, select appropriate devices complied to the regional standard.

MCA: Minimum Circuit Ampacity (Calculation based on UL1995)

CKT. BKR: Circuit Breaker



## 12. Safety devices

Type of protection	Protection form		Model
			ROMH45AFXZJ
Circuit protection	Current fuse (PCB)		250 V, 10 A 250 V, 5 A 400 V, 5 A 250 V, 3.15 A
	Protector (PCB)		500 V, 45 A
Fan motor protection	Thermal protection program		Activate 239±27 °F (115±15 °C) Fan motor stop
			Reset 158 °F (70 °C) Fan motor restart
Compressor protection	Thermal protection program (Compressor temp.)		Activate 226 °F (108 °C) Compressor stop
			Reset 176 °F (80 °C) Compressor restart
	Thermal protection program (Discharge temp.)		Activate 230 °F (110 °C) Compressor stop
			Reset After 3 minutes and 230 °F (110 °C) less than Compressor restart

# 13. Function settings

## 13-1. Setting methods

### ⚠ WARNING

Never touch electrical components such as the terminal blocks or reactor except the switch on the display board. It may cause a serious accident such as electric shock.

### ⚠ CAUTION

- Once refrigerant charging is completed, be sure to open the valve prior to performing the local settings. Otherwise, the compressor may fail.
- Discharge any static electricity from your body before touching the push switches. Never touch any terminal or pattern of any parts on the control board.

The positions of the switches on the outdoor unit control board are shown in the figure below.

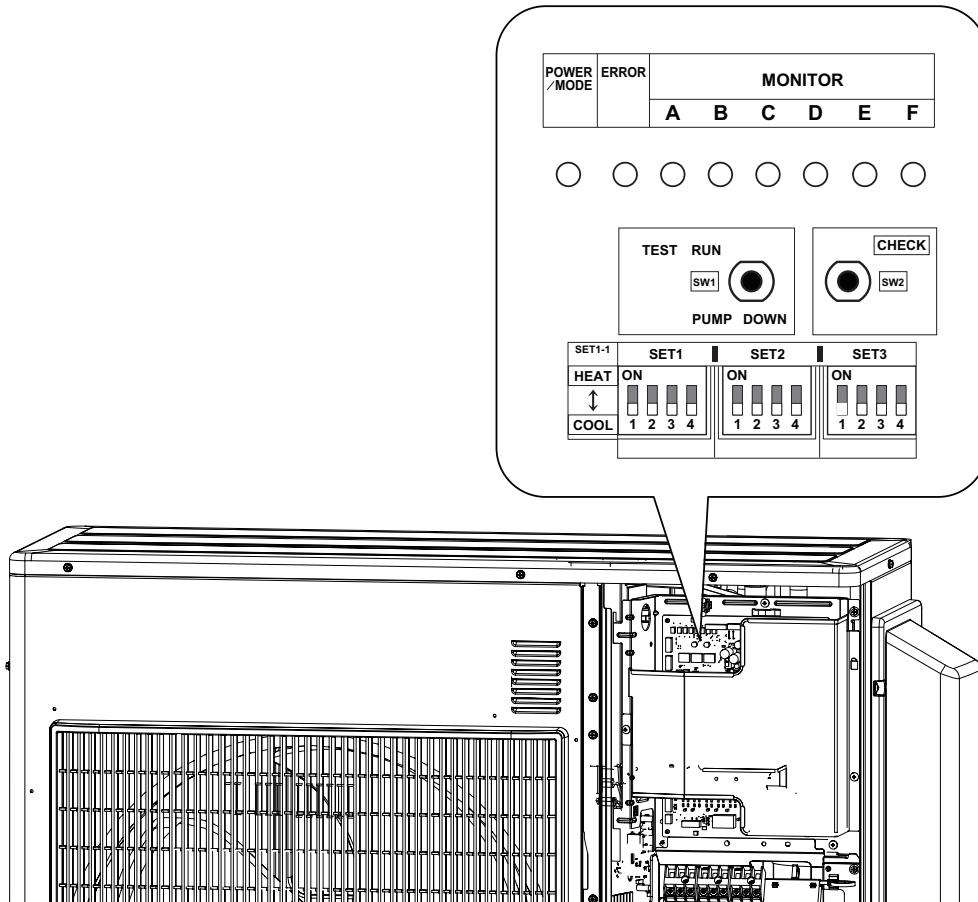

## ■ Setting method

1. Be sure to disconnect the power supply or turn off the breaker.
2. Change the DIP switch setting according to the required setting.
  - Various settings can be adjusted by changing DIP switches and push switches on the board of the outdoor unit.
  - The printed characters for the LED display are shown below.

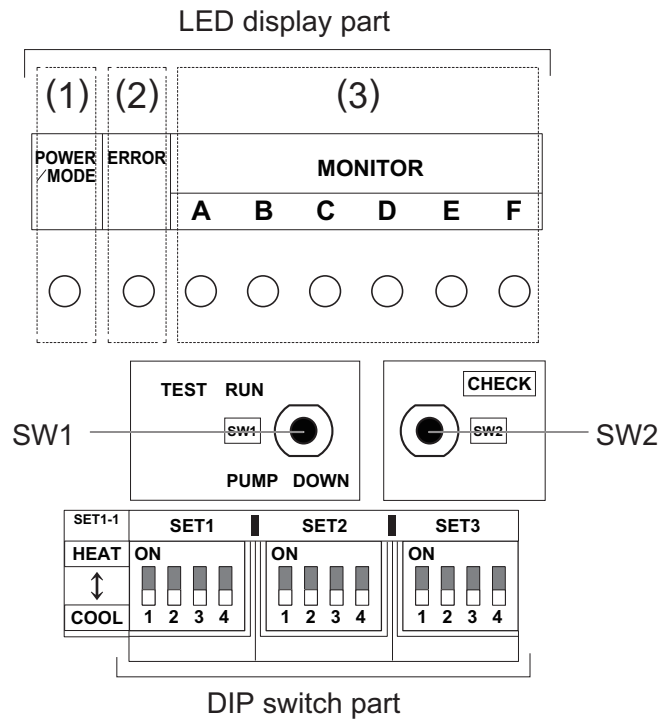

## ■ Description of display

LED display lamp			Function or operation method
(1)	POWER/MODE	Green	<ul style="list-style-type: none"> <li>Turns on when the power supply is ON (Including when error occurs).</li> <li>Indicate the MODE by the number of flashes when the installation function is active.</li> </ul>
(2)	ERROR	Red	Flashes at high-speed when there is an error.
(3)	MONITOR	A	<ul style="list-style-type: none"> <li>Displays the location and contents of errors when there is an error. (Refer to Chapter 14-3. "<a href="#">Error code</a>" on page 136 for details.)</li> <li>Displays when check run is activated. (Refer to Chapter 14-1. "<a href="#">Check run</a>" on page 128 for details.)</li> </ul>
		B	
		C	
		D	
		E	
		F	

Switch		Function or operation method	Factory setting
SW1	Push	<ul style="list-style-type: none"> <li>For the test run start and stop.</li> <li>For the pump down start and stop.</li> </ul>	—
SW2	Push	<ul style="list-style-type: none"> <li>For when check run function is activated.</li> <li>For displaying the check run.</li> <li>For resetting the Automatic wiring correction memory.</li> </ul>	—
SET1-1	DIP	For selecting cooling or heating during test operation.	OFF
SET1-2	DIP	For switching SW1 operation.	OFF
SET1-3	DIP	(Prohibited)	OFF (Do not change)
SET1-4	DIP	(Prohibited)	OFF (Do not change)
SET2-1	DIP	<ul style="list-style-type: none"> <li>For selecting outdoor unit low noise operation function.</li> <li>To use this function, the Central remote controller (option) is necessary.</li> </ul>	OFF
SET2-2	DIP	(Prohibited)	OFF (Do not change)
SET2-3	DIP	(Prohibited)	OFF (Do not change)
SET2-4	DIP	(Prohibited)	OFF (Do not change)
SET3-1	DIP	(Prohibited)	OFF (Do not change)
SET3-2	DIP	(Prohibited)	OFF (Do not change)
SET3-3	DIP	(Prohibited)	OFF (Do not change)
SET3-4	DIP	(Prohibited)	OFF (Do not change)

Be sure to disconnect the power supply or turn off the breaker before changing the DIP switch setting.

## 13-2. Outdoor unit low noise operation function (option)

Change the outdoor unit low noise operation by using this setting. Optional Central remote controller is necessary to use this function.

SET2-1	Setting	Factory setting
ON	Lower	
OFF	Low	◆

### **⚠ CAUTION**

- When the low noise operation function is working, cooling and heating capacity will decrease.
- When changing the settings, explain to the customer beforehand that the capacity decreases.

## 14. Check and test

### 14-1. Check run

- The check run is a function to screen and detect any wiring errors.
- After carrying out the check run, you can use the automatic wiring correction function to correct the wiring.
- Normal operation is possible without using the check run. In this case, use the test run or forced cooling function of the indoor unit to confirm any wiring errors.

#### ■ Things to confirm before starting the check run

To ensure safety, check that the following work, inspections and operations have been completed.

Check item		Check column
1	Check that all work on the piping connecting the outdoor unit, indoor units has been completed.	
2	Check that all work on the wiring connecting the outdoor unit, indoor units has been completed.	
3	Is there a gas leakage? (At pipe connections [flange connections and brazed areas])	
4	Is the system charged with the specified volume of refrigerant?	
5	Is a breaker installed at the power supply cable of outdoor unit?	
6	Are the wires connected to the terminals without looseness, and in accordance with the specifications?	
7	Is the 3-way valve of the outdoor unit open? (Gas pipe and liquid pipe)	
8	Is the power supply connected for more than 12 hours?	

#### ■ Restrictions applicable when performing the check run

- When the check run starts, all indoor units connected to the outdoor unit will start to run automatically. During the check run, you cannot check the operation of the indoor units separately. After the check run, check the operation of the indoor units separately in normal operation.
- The check run can be used when the temperature is within the operable temperature of the air conditioner.
- In the check run, the air conditioner will automatically switch between cooling and heating depending on the external temperature and internal temperature.
- The check run can be completed in about 30 minutes (cooling) or about 1 hour (heating), but may take more depending on the external and internal temperature conditions etc.
- Do not conduct the check run with all the windows in the room closed. Otherwise the room temperature could get too low or too high.
- Depending on the difference of the room temperature of each room, a judgment may be impossible.
- Check run is a special operation so there may be a noise louder than the normal refrigerant noise or a creaking noise.

## ■ Operating procedure for check run

### ⚠ CAUTION

Initiate check run after more than 12 hours after the power supply is connected.

**NOTE:** Be sure that the indoor unit and outdoor unit are not operating before starting the check run.

1. Press the "CHECK" switch for 3 seconds or more.

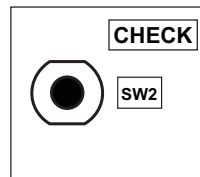

2. The number of indoor units (and the places) connected through the communication lines is displayed.
  - If the displayed number of units (places) and the installed number of units (places) is the same, proceed to step 3.
  - If the displayed number of units (places) and the installed number of units (places) is not the same, shut off the power and check whether the indoor and outdoor communication lines are properly connected.
  - If there is no operation for 1 minute, the LED will return to the original display. (POWER/MODE LED: ON)

**Example: When 4 indoor units (A to D) are connected**

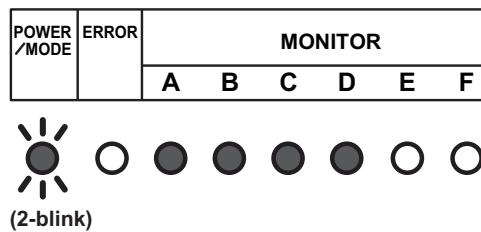

3. Press the "CHECK" switch for 3 seconds or more again. Check run is initiated.
  - When check run is initiated, all LEDs from A to F will flash. (Preliminary operation)
  - The LED for each indoor unit will switch off in order as check for each unit is completed.

**NOTE:** To interrupt the check run, press the "CHECK" switch.

**Example: When 4 indoor units (A to D) are connected**

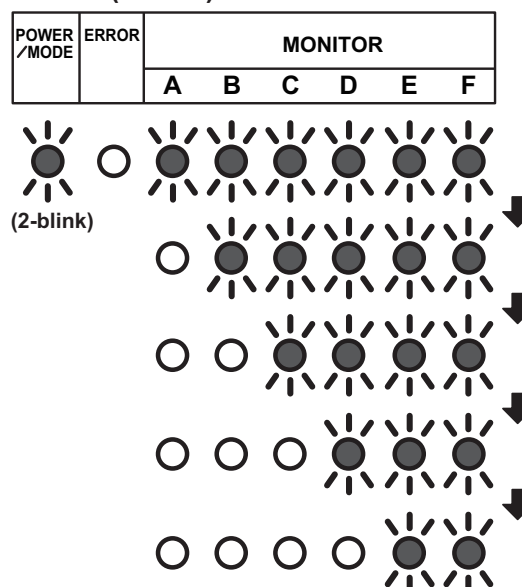

4. After the check run is completed, results will be displayed. Fill the displayed results in the result table accordingly.

• **If the connection is correct (Example: When 4 indoor units are connected)**

After the number of connected units are displayed, the LED for each unit will light up in order from A to D.

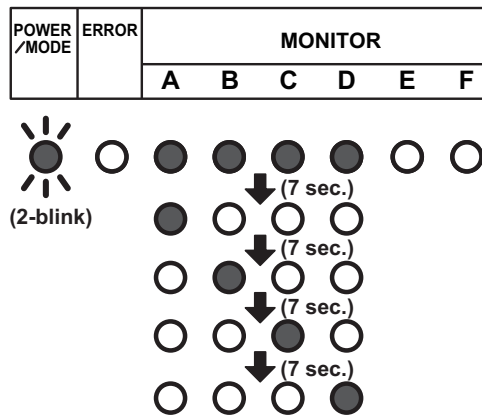

• **If the connection is incorrect (Example: When connection of B and C of the 4 units are reversed)**

After the number of connected units are displayed, B and C will light up in reverse.

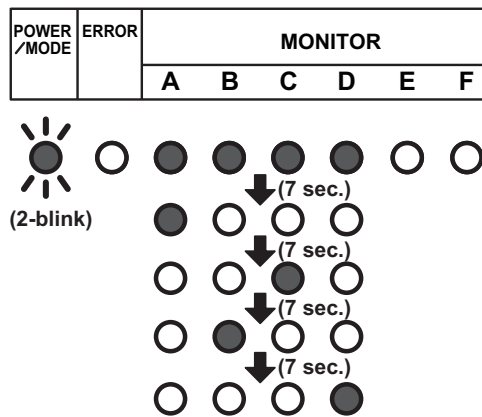

**NOTES:**

- Automatic wiring correction will not be completed if the power supply is disconnected while displaying the results. To confirm the automatic wiring correction, be sure to carry out step 5.
- If frost is formed on the outdoor unit while displaying the results, automatic defrost function will be operated. Proceed to step 5 after the defrost function is finished.



**[How to record the contents]**

- Fill the displayed results according to the following example.

Example: When piping A to D is connected but the wires for B and C are connected in reverse.

<Displayed results>

The LEDs will light up in 7 second intervals in the following order.

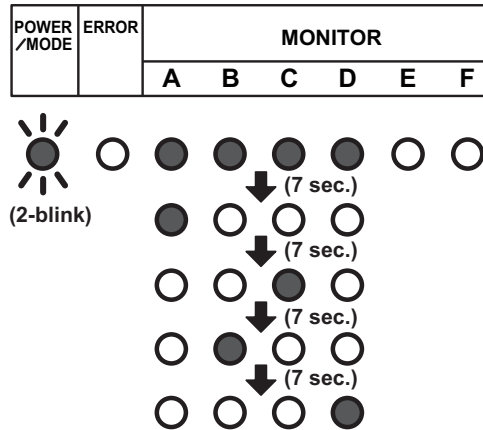

<Example of result table>

- a. Please write a ● where the LEDs light up in the order that they light up.

	A	B	C	D	E	F
1	●	●	●	●	○	○
2	●	○	○	○	○	○
3	○	○	●	○	○	○
4	○	●	○	○	○	○
5	○	○	○	●	○	○
6	○	○	○	○	○	○
7	○	○	○	○	○	○

- b. Based on the results of step (a), please record as follows.

- Trace the dotted circle with a pen if multiple places light up.

A	B	C	D	E	F
○	○	○	○	⊘	⊘

- Write the order from A to D in which the LEDs lit up inside the circle.

A	B	C	D	E	F
Ⓐ	Ⓒ	Ⓑ	Ⓓ	⊘	⊘

- c. Select the correction method.

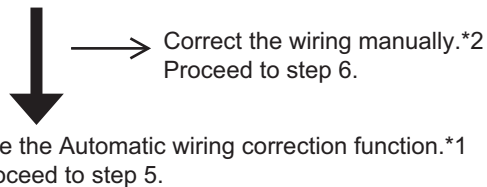

Write down the same results in the label on the reverse side of the service panel.  
The results recorded are needed at the time of servicing.

**NOTES:**







- \*1: By using this function, the wiring is automatically corrected according to the piping.
- \*2: When correcting the wiring manually, please disconnect the power supply or turn off the breaker during results display, and then change the wiring manually according to the obtained test results.

For example, in Example 1, the wirings connected to the terminals B and C is to be exchanged manually.

**<Result Table>**

	A	B	C	D	E	F
1	○	○	○	○	○	○
2	○	○	○	○	○	○
3	○	○	○	○	○	○
4	○	○	○	○	○	○
5	○	○	○	○	○	○
6	○	○	○	○	○	○
7	○	○	○	○	○	○

A	B	C	D	E	F
					

5. During results display, press the "CHECK" switch for 3 seconds or more. After LEDs A to F have lit in turn, all LEDs will light up indicating that the automatic wiring correction is completed.

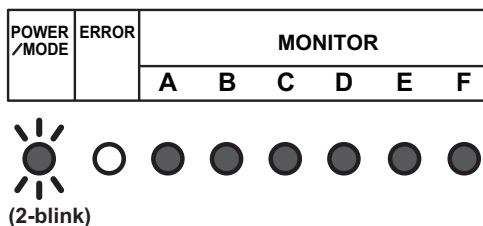

6. Disconnect the power supply or turn off the breaker and wait 10 minutes then turn the power back on and perform test run.

**NOTE:** If you do not disconnect the power supply or turn off the breaker, normal operation is not possible.

**Notices:**

- If an error occurs during check run it will be suspended. Correct the error and start check run again.
- After the check run, if automatic wiring correction is carried out, the indoor unit's position will be modified to match the piping. (Note that the display of the optional remote controller changes.)
- If you start check run again after the automatic wiring correction is finished, the modification will be reset.

## ■ Check run judgment failure display

If check run cannot be performed, the following is displayed. In this case, the check run will stop. Please check by using the cooling test run of the indoor unit.

### ● Temperature out of range judgment

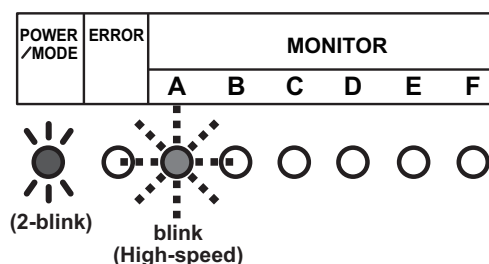

### ● Wiring/piping number difference

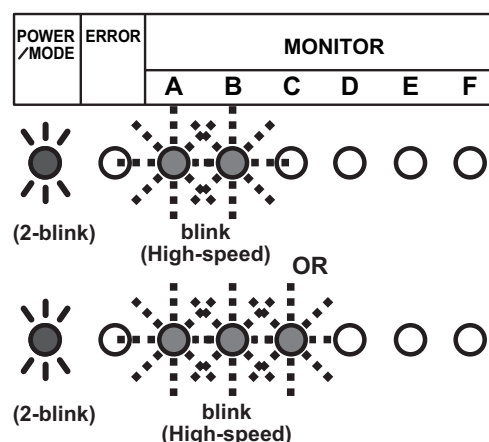

## ■ Re-display check run results

- If you wish to check the automatic wiring correction contents, by briefly pressing the "CHECK" switch, the check run results is displayed. Check the check run results by referring to the result table in step (4) of "Chapter 14-1-3. ["Operating procedure for check run"](#) on page 129".
- If the automatic wiring correction contents has not been done, the POWER/MODE LED will blink twice and the MONITOR LED will turn off.

## ■ Automatic wiring correction memory reset

### **⚠ CAUTION**

When relocating the unit, reset the memory beforehand, or the unit may not function normally.

1. Press the "CHECK" switch.  
The LED will light as shown in "["Re-display check run results"](#) on page 133".
2. Press the "CHECK" switch for more than 3 seconds when the LED is on.
3. The LEDs from A to F will light in sequence, and then all LEDs will light to indicate the completion of the Automatic wiring correction memory reset.
4. Disconnect the power supply or turn off the breaker.

## 14-2. Test run

### CAUTION

Always connect the power supply 12 hours prior to the start of the operation in order to protect the compressor.

1. Indoor unit
    - a. Is the drain normal?
    - b. Is there any abnormal noise and vibration during operation?
  2. Outdoor unit
    - a. Is there any abnormal noise and vibration during operation?
    - b. Will noise, wind, or drain water from the unit disturb the neighbors?
    - c. Is there any gas leakage?
- Do not operate the air conditioner in the test running state for a long time.
  - For the operation method of the test run for indoor unit and central remote controller, refer to the operating manual and perform operation check.

### ■ Test run method

Be sure to temporarily disconnect the power supply or turn off the breaker before changing the DIP switch settings.

1. Check the 3-way valves (both at the liquid side and gas side) are opened. Confirm that the DIP switch SET1-2 is switched off.
2. Set the operation mode to "COOL" or "HEAT". When switching the DIP switch SET1-1 between HEAT and COOL, disconnect the power supply or turn off the circuit breaker beforehand.

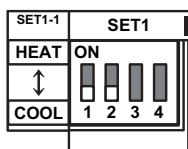

- In the first test run, be sure to set the operation mode to "COOL".
  - The operation mode cannot be switched between "COOL" and "HEAT" during the test run. To switch the operation mode between "COOL" and "HEAT", stop the test run, switch the operation mode, and then start the test run again.
3. Press "TEST RUN" switch for more than 3 seconds.  
The POWER / MODE LED flashes once.

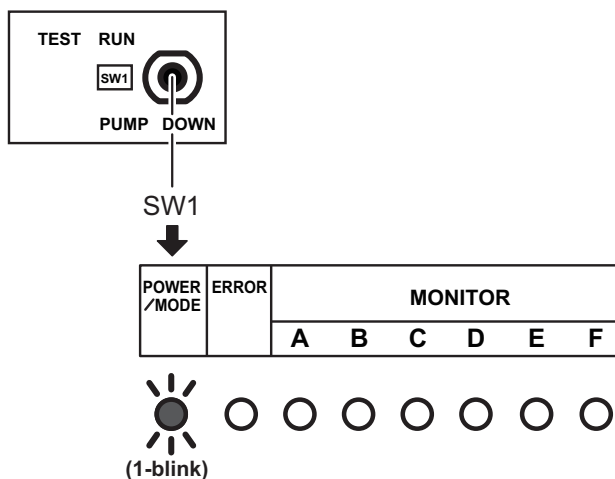

4. Confirm operating status.

5. Press "TEST RUN" switch for more than 3 seconds.

POWER /MODE	ERROR	MONITOR					
		A	B	C	D	E	F



POWER/MODE LED will turn on, and test run stops.

## 14-3. Error code

If an error occurs, the LED will light up to display the error location and the error code.

### ■ In the event of an error

The error LED blink quickly.

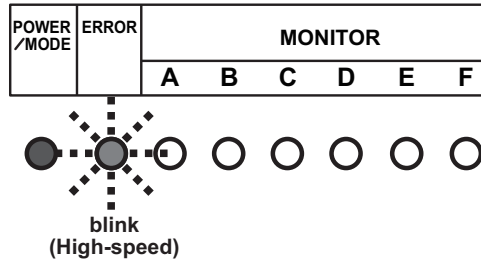

### ■ Error location display

LEDs A to F of MONITOR light up and display the error location. In the case of an overall error, LEDs A to F of MONITOR do not light up.

**Example:** Coil error in indoor unit B

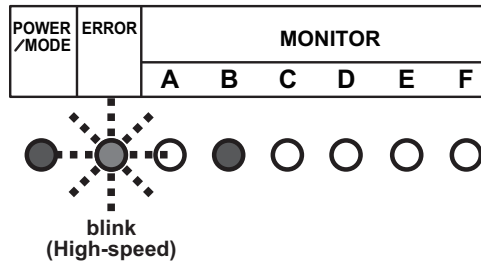

## ■ Error code display

While the error is occurring, briefly press SW1. The error code is displayed.

**Example: Coil error (Error cord = 9A.1)**

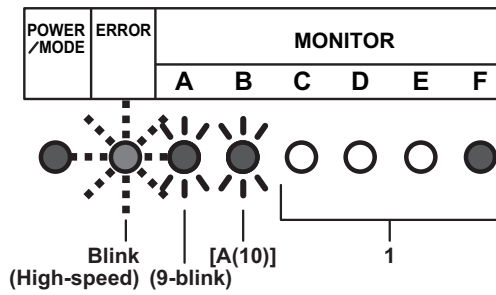

### Display mode

LED on: ●

LED off: ○

Blink:   
(0.5s Light on / 0.5s Light off)

Number of blinking: ( )

For MONITOR (A and B)

A: 10-Blink

C: 11-Blink

F: 12-Blink

J: 13-Blink

P: 14-Blink

U: 15-Blink

C	D	E	F	
○	○	○	●	→ 1
○	○	●	○	→ 2
○	○	●	●	→ 3
○	●	○	○	→ 4
○	●	○	●	→ 5
○	●	●	○	→ 6
○	●	●	●	→ 7
●	○	○	○	→ 8
●	○	○	●	→ 9
●	○	●	○	→ A
●	○	○	●	→ C
●	●	○	○	→ F
●	●	○	●	→ J
●	●	●	○	→ P
●	●	●	●	→ U

Error code	Error type
11.3	Serial communication error
11.4	Serial communication error during operation
16.5	Communication error between controller and outdoor unit
22.1	Indoor unit capacity error
5U.1	Indoor unit error
62.1	PCB model information error
62.3	EEPROM access error
62.8	EEPROM data corruption error
63.1	Inverter error
65.3	IPM error (Trip terminal L error)
71.1	Discharge temp. sensor error
72.1	Compressor temp. sensor error
73.2	Heat exchanger middle temp. sensor error
73.3	Heat exchanger liquid temp. sensor error
74.1	Outdoor temp. sensor error
75.1	Suction gas temp. sensor error
76.1	Valve sensor error
76.2	
77.1	Heat sink temp. sensor error
84.1	Current sensor 1 error (stoppage permanently)
86.1	Discharge pressure sensor error
94.1	Trip detection
95.1	Compressor motor control error (stoppage permanently)
97.3	Fan motor 1 error (Duty error)
98.3	Fan motor 2 error (Duty error)
99.1	4-way valve error
9A.1	Coil 1 (expansion valve 1) error
A1.1	Discharge temperature 1 error (stoppage permanently)
A3.1	Compressor 1 temperature error



## 14-4. Pump down

### **⚠ WARNING**

During the pump down operation, make sure that compressor is off before you remove the refrigerant piping. Do not remove the connection pipe while the compressor is in operation with valve open. This may cause abnormal pressure in the refrigeration cycle that leads to breakage and even injury.

### ■ Pump down operation

When moving or discarding the air conditioner, in order to consider the environment and avoid the discharge of refrigerant to the atmosphere, pump down according to the following procedure.

1. Connect the pressure gauge to the charging port.
2. Change the DIP switch on the board (SET1-2) to On\*1  
\*Be sure the power supply is disconnected on the breaker is turned off when changing the DIP switch.

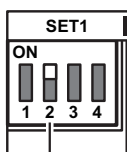

\*1: DIP switch (SET1-2)

3. To start operation, press the [PUMP DOWN] switch\*2 for 3 seconds or press after the power has been on for 3 min.

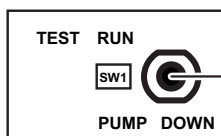

\*2: Push switch (SW1)

During pump down, the LED (POWER/MODE) will flash 3 times consecutively.

POWER /MODE	ERROR	MONITOR					
		A	B	C	D	E	F



**NOTE:** If the [PUMP DOWN] switch is pressed during compressor operation, the compressor will stop, and the operation will start after about 3 min.

4. Close the liquid pipe valve.
5. When the value between 7.3 psi and 0 psi (0.05 Mpa to 0 Mpa) is shown, close the gas pipe valve.
6. Stop pump down by pressing the [PUMP DOWN] switch for 3 seconds.  
The LED will light as follows.

POWER /MODE	ERROR	MONITOR					
		A	B	C	D	E	F







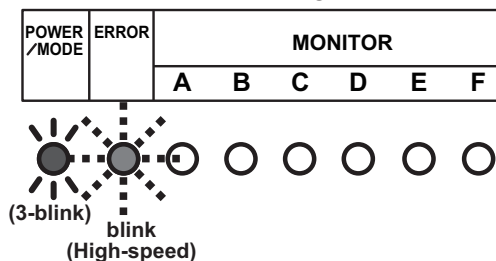



7. Disconnect the power supply or turn off the breaker.

**NOTE:** If the pump down is not stopped by pressing the switch as in step 6, it will stop automatically after 15 minutes and the LED will light as follows. If the pump down is complete, disconnect the power supply or turn off the breaker. If not completed open the liquid pipe valve, and then start again from step 3.

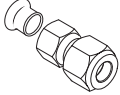

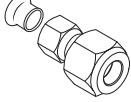
- In order to interrupt the pump down operation, press the [PUMP DOWN] switch again. The LED will return to the original display before starting pump down. (POWER/MODE LED: On)
- The pump down may stop before completion due to error. To complete the pump down, correct the error, open the liquid pipe valve and then start from step 1 again. Otherwise, the refrigerant can be recovered from the service port.

## 15. Accessories

Part name	Exterior	Q'ty	Part name	Exterior	Q'ty
Installation manual		1	Drain cap		7
Drain pipe		1	Adapter K 1/2 in (12.70 mm) 3/8 in (9.52 mm)		2 set
Cable tie with clip (Large)		2	Adapter L 1/2 in (12.70 mm) 5/8 in (15.88 mm)		2 set
Cable tie with clip (Small)		2	Adapter H 3/8 in (9.52 mm) 1/2 in (12.70 mm)		1 set
Cable tie		1			

## 16. Outdoor unit installation precautions

**NOTE:** The information listed below are general precautions.  
Some models also include items that do not apply.

### 16-1. Place where prohibited for use

- Places where there is a danger of combustible gas leakage.
- Places where sulfur gas, chlorine gas, acid, alkali, or other matter which effects equipment is generated.
- Places not affected by heat radiation from other heat sources.
- Places where the air is not stagnant.
- Places where machinery which generates high frequencies is used.
- Ocean beaches and other areas where there is a lot of salt.
- Inside of vehicles, ships, and other conveyances.
- Places where voltage fluctuations are product.

### 16-2. Points to remember when installing

- The product shall be installed at a place which can withstand the weight and vibration of the outdoor unit.
- To allow maintenance after refrigerant piping, drain piping, and electric wiring connection and installation, provide an installation service space.  
\*Installation service space is shown in "[Installation space](#)" on page 84.
- Be careful when installing the set at the following places.

Condition	Contents	Countermeasures (Reference)
When installed near adjacent houses.	Perform installation work so that operating sound does not disturb the neighbors.	<ol style="list-style-type: none"> <li>1. Install a soundproof barrier.</li> <li>2. Change the installation site.</li> </ol>
When there is the possibility of strong wind.	<ul style="list-style-type: none"> <li>• If the outdoor unit is exposed to strong wind, capacity may drop, frost may form during heating, and operation may be stopped by high pressure rise. In addition, when a very strong wind blows, the fan may be damaged.</li> <li>• When a very strong wind blows, there is the possibility of the outdoor unit being toppled over if held only by foundation bolts.</li> </ul>	<ol style="list-style-type: none"> <li>1. Install the outdoor unit with keeping a sufficient distance between the outlet side of the unit and a facing wall or fence.</li> <li>2. Make the outlet direction and wind direction perpendicular.</li> <li>3. Fasten the outdoor unit using toppling prevention hardware (purchased locally).</li> </ol>
When snow accumulates.	If the outdoor unit is covered by accumulated snow, it may not be able to operate.	<ol style="list-style-type: none"> <li>1. Make the foundation as high as possible.</li> <li>2. Perform snow prevention work.</li> </ol>
When installing the inverter type.	It may generate noise in TV sets, stereos and PCs.	The inverter type should be installed at a sufficient distance from these equipments.