



The new degree of comfort.™

Rheem High Efficiency Air Handler

RH1V/RH2V- Series

ECM Motor

Efficiencies up to 16 SEER



- Includes an energy efficient ECM® Motor, which in most applications, enhances the SEER rating of the outdoor unit. It also slowly ramps its speed up for quiet operation and enhanced customer satisfaction.
- Versatile 4-way convertible design for upflow, downflow, horizontal left and horizontal right applications.
- Nominal airflow up to 1.0" external static pressure.
- Factory-installed indoor coil.
- Sturdy cabinet construction with 1.0 inch [25.4 mm] of foil faced insulation for excellent sound and insulating characteristics.
- Field-installed auxiliary electric heater kits provide exact heat for indoor comfort. Kits include circuit breakers which meet U.L. and cUL requirements for service disconnect.
- Dip switch settings for selectable, customized cooling airflow over a wide variety of applications.
- On-demand dehumidification terminal that adjusts airflow to help control humidity for unsurpassed comfort in cooling mode.
- External filter required.
- Evaporator coil is constructed of aluminum fins bonded to internally grooved aluminum tubing.



TABLE OF CONTENTS

Engineering Features	3
Model Number Identification	4
Dimensional Data	5-6
Airflow Directional Data	7
Airflow Performance Data (-)H1V	8-9
Electrical Data (-)H1V	10-11
Airflow Performance Data (-)H2V	12
Electrical Data (-)H2V	13-14
Electrical Wiring	15
Accessories	15
Limited Warranty	16

Engineering Features

RH1V/RH2V- Series

- Quiet, efficient ECM motor technology providing nominal airflow up to 1.0 inch [25 kPa] of external static pressure.
- Interface board with dip switches conveniently located in the blower compartment allows for precise, field selectable airflow to meet the requirements of particular applications.
- Selectable continuous fan “on” options.
- The most compact unit design available.
- Attractive pre-painted cabinet exterior.
- Rugged steel cabinet construction, designed for added strength and versatility.
- 1.0" foil faced insulation mechanically retained in blower compartment.
- Four leg rubber insulated motor mount.
- Field-installed auxiliary heater kit includes circuit breakers that meet UL and cUL requirements as a service disconnect switch.
- Blower housing with integrated controls, motor and blower. Slide out design for service and maintenance convenience.
- Field convertible for vertical upflow, vertical downflow, horizontal left hand or right hand air supply.
- Combustible floor base accessory available when required for downflow installations on combustible floors.
- Indoor coil design provides low air side pressure drop, high performance and extremely compact size. All coils come with PVC condensate elbow standard.
- Coils are constructed of aluminum fins bonded to internally grooved aluminum tubing.
- Coils are tested at the factory with an extensive refrigerant leak check.
- Coils have copper sweat refrigerant connections.
- Coils utilize chatleff metering device connections.
- Molded polymer corrosion resistant condensate drain pan is provided on all indoor coils.
- Supply duct flanges provided as standard on air handler cabinet.
- Provisions for field electrical connections available from either side or top of the air handler cabinet.
- Connection point for high voltage wiring is inside the air handler cabinet. Low voltage connection wiring is made on the outside of the air handler cabinet.
- Concentric knockouts are provided for power connection to cabinet. Installer may pull desired hole size up to 2 inches [51 mm] for 1½ inch [38 mm] conduit.
- Front refrigerant and drain connections.

[] Designates Metric Conversions

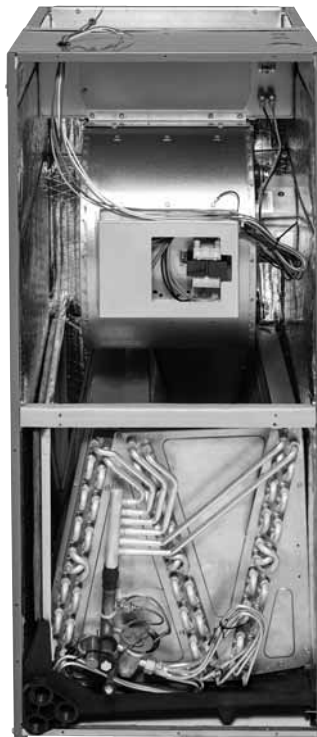

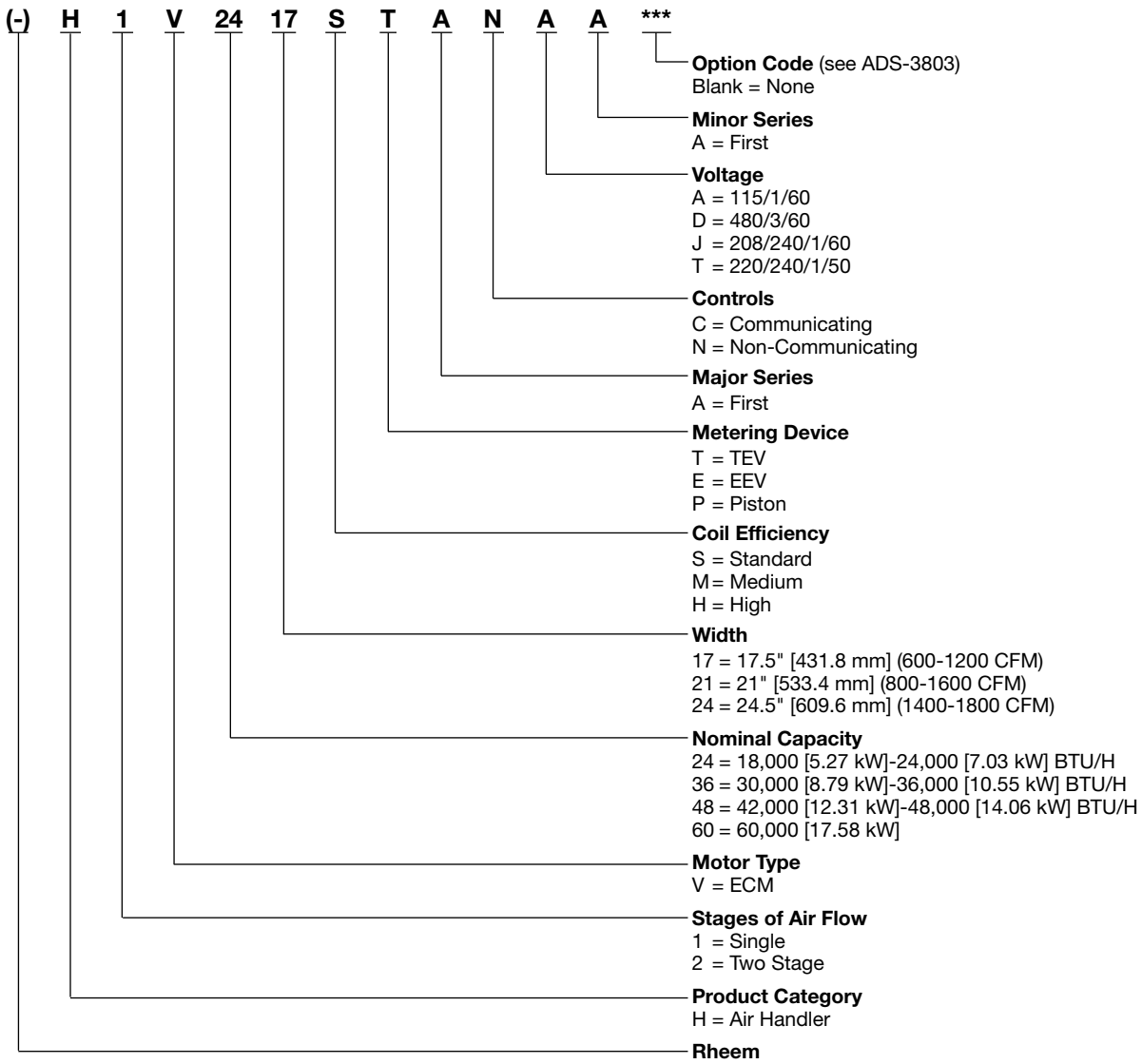

[] Designates Metric Conversions

Available Models
RH1V2417STANJA
RH1V3617STANJA
RH1V3621MTANJA
RH1V4821STANJA
RH1V4824STANJA
RH1V6024STANJA
RH2V2421HTACJA
RH2V3624HTACJA
RH2V4824HTACJA
RH2V6024HTACJA

Unit Dimensions

ELECTRICAL CONNECTIONS
MAY EXIT TOP OR EITHER SIDE
HIGH VOLTAGE CONNECTION 7/8" [22.2 mm],
1 3/32" [27.8 mm], 1 1/2" [50 mm] DIA. KNOCKOUTS.

LOW VOLTAGE CONNECTION
3/8" [15.9 mm] AND 7/8" [22.2 mm] KNOCKOUT

AUXILIARY DRAIN CONNECTION
3/4" [19.1 mm] FEMALE PIPE THREAD (NPT)
HORIZONTAL APPLICATION ONLY

PRIMARY DRAIN CONNECTION
3/4" [19.1 mm] FEMALE PIPE THREAD (NPT)

AUXILIARY DRAIN CONNECTION
3/4" [19.1 mm] FEMALE PIPE THREAD (NPT)
UPFLOW/DOWNFLOW APPLICATION ONLY

LIQUID LINE CONNECTION
COPPER (SWEAT)

VAPOR LINE CONNECTION
COPPER (SWEAT)

SUPPLY AIR ↑

NOTE: 24" CLEARANCE REQUIRED IN FRONT OF
UNIT FOR FILTER AND COIL MAINTENANCE.

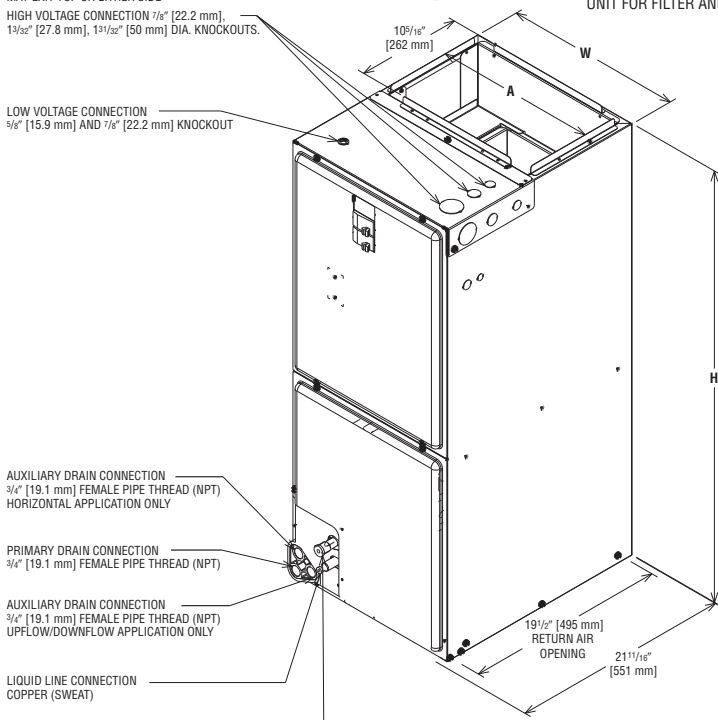

UPFLOW UNIT SHOWN:
UNIT MAY BE INSTALLED UPFLOW, DOWNFLOW,
HORIZONTAL RIGHT OR LEFT AIR SUPPLY.

Return Air Opening Dimensions

Model Cabinet Size	Return Air Opening Width (Inches)	Return Air Opening Depth/Length (Inches)
17	15 7/8	19 3/4
21	19 3/8	19 3/4
24	22 7/8	19 3/4

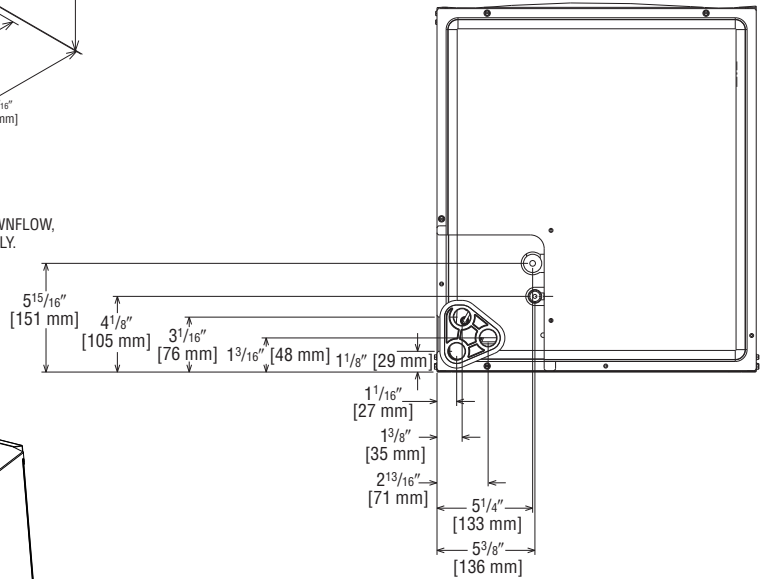

UPFLOW UNIT SHOWN:
UNIT MAY BE INSTALLED UPFLOW,
DOWNFLOW, HORIZONTAL RIGHT
OR LEFT AIR SUPPLY.

[] Designates Metric Conversions
() Designates Unit with Double Coil Cabinet

[] Designates Metric Conversions
() Designates Unit with Double Coil Cabinet

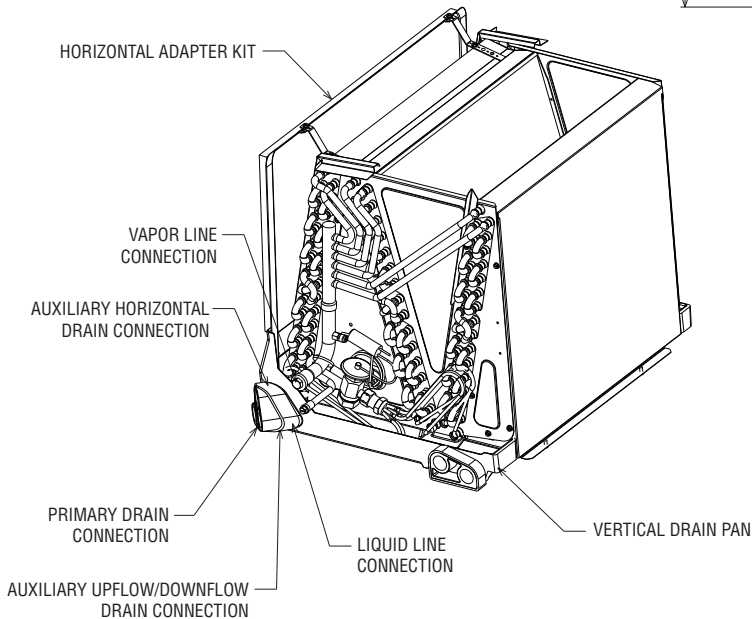

Unit Dimensions & Weights

Model Size RH1V	Refrigerant Connections Sweat (In.) [mm] ID		Unit Width "W" In. [mm]	Unit Height "H" In. [mm]	Supply Duct "A" In. [mm]	Air Flow CFM (Nom.) [L/s]		Unit Weight/Shipping Weight (Lbs.) [kg]
	Liquid	Vapor				Lo	Hi	Unit With Coil (Max. KW)
2417ST	3/8 [9.53]	3/4 [19.05]	17 1/2 [445]	42 1/2 [1080]	16 [406]	600 [283]	800 [378]	82/96 [37/44]
3617ST	3/8 [9.53]	3/4 [19.05]	17 1/2 [445]	42 1/2 [1080]	16 [406]	1000 [472]	1200 [566]	90/104 [41/47]
3621MT	3/8 [9.53]	7/8 [22.23]	21 [533]	50 1/2 [1282]	19 1/2 [495]	1000 [472]	1200 [566]	126/142 [57/64]
4821ST	3/8 [9.53]	7/8 [22.23]	21 [533]	50 1/2 [1282]	19 1/2 [495]	1400 [661]	1600 [755]	130/146 [59/66]
4824ST	3/8 [9.53]	7/8 [22.23]	24 1/2 [622]	50 1/2 [1282]	23 [584]	1600 [755]	—	142/160 [64/72]
6024ST	3/8 [9.53]	7/8 [22.23]	24 1/2 [622]	55 1/2 [1410]	23 [584]	—	1800 [850]	162/179 [73/81]

Model Size RH2V	Refrigerant Connections		Matched to Outdoor Unit	Unit Width "W" In. [mm]	Unit Height "H" In. [mm]	Supply Duct "A" In. [mm]	Nominal Coil Airflow [L/s]				Unit Weight/Shipping Weight (Lbs.) [kg]
	Sweat (in.) [mm] ID						1st Stage		2nd Stage		Unit With Coil (Max. KW)
	Liquid	Vapor					ODD*	Normal	ODD*	Normal	
2421HT	3/8 [9.53]	3/4 [19.05]	(-)ARL/(-)ASL-024JEC	21 [533]	42 1/2 [1080]	19 1/2 [495]	500 [236]	600 [283]	650 [307]	775 [366]	99/117 [45/51]
3624HT	3/8 [9.53]	7/8 [22.23]	(-)ASL-039JEC	24 1/2 [622]	55 1/2 [1410]	23 [584]	725 [342]	825 [389]	975 [460]	1175 [555]	129/146 [59/66]
			(-)ARL/(-)ASL-0935JEC				825 [389]	950 [448]	1000 [472]	1175 [555]	
4824HT	3/8 [9.53]	7/8 [22.23]	(-)ASL-048JEC	24 1/2 [622]	55 1/2 [1410]	23 [584]	825 [389]	1000 [472]	1300 [614]	1600 [755]	143/160 [65/72]
			(-)ARL-048JEC				1000 [472]	1200 [566]	1350 [637]	1600 [755]	
6024HT	3/8 [9.53]	7/8 [22.23]	(-)ASL-060JEC	24 1/2 [622]	55 1/2 [1410]	23 [584]	925 [437]	1050 [496]	1325 [625]	1700 [802]	159/176 [72/80]
			(-)ARL-060JEC				1025 [484]	1275 [602]	1400 [661]	1700 [802]	

*Maximum dehumidification airflow.

[] Designates Metric Conversions

Airflow Directional Data

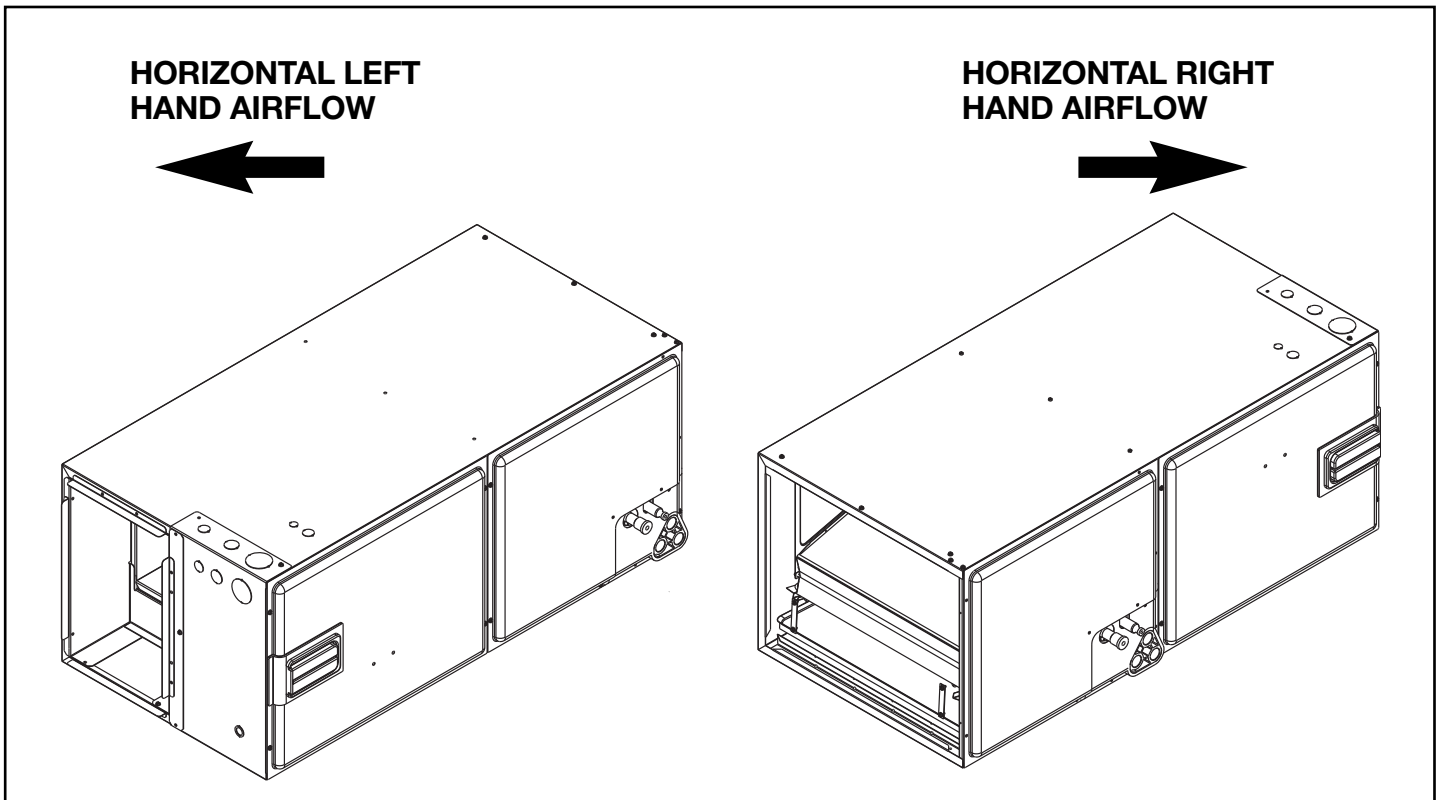
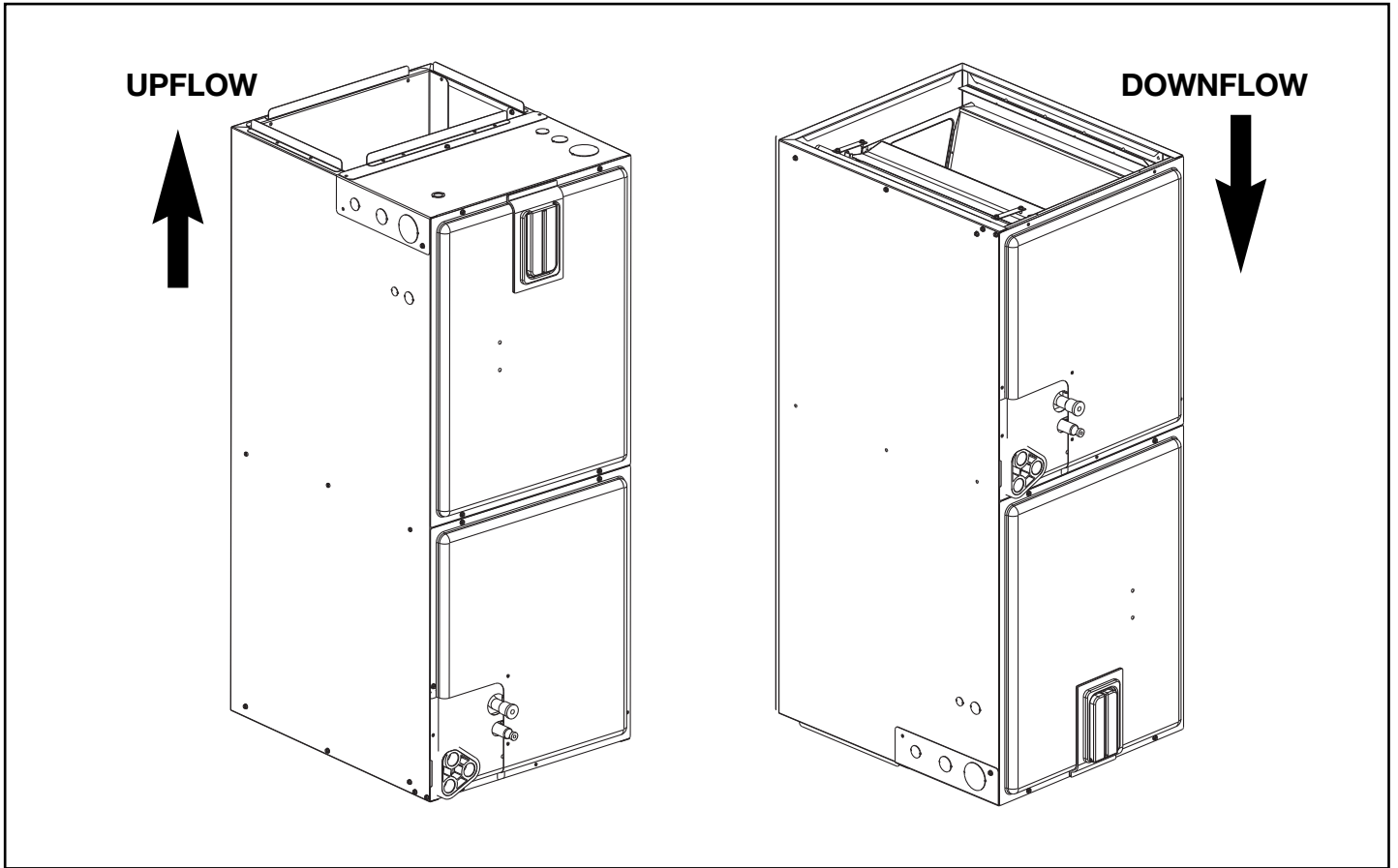

Airflow Performance

Airflow performance data is based on cooling performance with a coil and no filter in place. Select performance table for appropriate unit size, voltage and number of electric heaters to be used. Make sure external static applied to unit allows operation within the minimum and maximum limits shown in table

below for both cooling and electric heat operation. For optimum blower performance, operate the unit in the .3 [8 mm] to .7 inches [18 mm] W.C. external static range. Units with coils should be applied with a minimum of .1 inch [3 mm] W.C. external static range.

Airflow Performance and Electrical Data RH1V

Model No. RH1V	Tonnage Application	Motor Speed From Factory	Nominal Air-Flow CFM	Blower Size/ Motor HP [W]	ECM										
					CFM Air Delivery/RPM/Watts—230 Volts										
					External Static Pressure—Inches W.C. [kPa]										
					0.1 [.02]	0.2 [.05]	0.3 [.07]	0.4 [.10]	0.5 [.12]	0.6 [.15]	0.7 [.17]	0.8 [.20]	0.9 [.22]	1.0 [.24]	
2417ST No Heater	1.5 Ton	High	600*	10x8 1/3 [249] 5 Speed	CFM [L/s]	597 [282]	608 [287]	607 [286]	616 [291]	616 [291]	618 [292]	613 [289]	608 [287]	600 [283]	594 [280]
					RPM	522	609	673	757	815	869	938	995	1051	1097
					Watts	57	74	89	115	130	144	169	190	212	232
2417ST with 13 kW Heat	1.5 Ton	High	600*	10x8 1/3 [249] 5 Speed	CFM [L/s]	588 [278]	598 [282]	596 [281]	605 [286]	603 [285]	605 [286]	600 [283]	595 [281]	587 [277]	577 [272]
					RPM	536	608	723	805	864	919	989	1047	1104	1149
					Watts	65	85	100	129	145	160	186	209	233	254
2417ST No Heat	2.0 Ton	High	800	10x8 1/3 [249] 5 Speed	CFM [L/s]	787 [371]	805 [380]	815 [385]	819 [387]	810 [382]	807 [381]	811 [383]	810 [382]	809 [382]	805 [380]
					RPM	614	682	763	818	868	917	972	1017	1070	1112
					Watts	97	113	144	167	191	209	239	259	289	311
2417ST with 13 kW Heat	2.0 Ton	High	800	10x8 1/3 [249] 5 Speed	CFM [L/s]	775 [366]	793 [374]	803 [379]	807 [381]	798 [377]	795 [375]	799 [377]	798 [377]	797 [376]	793 [374]
					RPM	630	700	783	839	891	941	997	1044	1098	1141
					Watts	111	130	165	192	219	240	275	298	332	357
3617ST No Heat	2.5 Ton	High	1000*	10x8 1/2 [373]	CFM [L/s]	1001 [472]	1030 [486]	1030 [486]	1035 [488]	1035 [488]	1029 [486]	1029 [486]	1029 [486]	1029 [486]	1023 [483]
					RPM	652	752	812	845	923	945	1007	1065	1090	1118
					Watts	134	166	193	212	244	266	280	320	341	357
3617ST with 18 kW Heat	2.5 Ton	High	1000*	10x8 1/2 [373]	CFM [L/s]	980 [463]	1009 [476]	1009 [476]	1014 [479]	1014 [479]	1008 [476]	1008 [476]	1008 [476]	1008 [476]	1002 [473]
					RPM	714	814	874	907	985	1007	1069	1127	1152	1180
					Watts	176	208	235	254	286	308	322	362	383	399
3617ST No Heat	3.0 Ton	High	1200*	10x8 1/2 [373]	CFM [L/s]	1220 [576]	1229 [580]	1229 [580]	1229 [580]	1229 [580]	1229 [580]	1238 [584]	1238 [584]	1233 [582]	1228 [580]
					RPM	732	831	875	930	981	1005	1077	1108	1156	1194
					Watts	215	253	282	314	348	362	409	426	472	496
3617ST with 18 kW Heat	3.0 Ton	High	1200*	10x8 1/2 [373]	CFM [L/s]	1199 [566]	1208 [570]	1208 [570]	1208 [570]	1208 [570]	1208 [570]	1217 [574]	1217 [574]	1212 [572]	1207 [570]
					RPM	794	893	937	992	1043	1067	1139	1170	1218	1256
					Watts	257	295	324	356	390	404	451	468	514	538
3621MT No Heat	2.5 Ton	High	1000*	10x10 3/4 [559]	CFM [L/s]	1000 [472]	1001 [472]	1011 [477]	1009 [476]	1005 [474]	1000 [472]	996 [470]	994 [496]	970 [458]	967 [456]
					RPM	593	650	737	801	867	914	980	1026	1058	1099
					Watts	103	124	155	177	207	224	258	287	301	323
3621MT with 15 kW Heat	2.5 Ton	High	1000*	10x10 3/4 [559]	CFM [L/s]	984 [464]	979 [462]	984 [464]	976 [461]	967 [456]	956 [451]	947 [447]	939 [443]	910 [429]	901 [425]
					RPM	627	689	780	849	919	971	1041	1092	1128	1174
					Watts	124	151	187	215	250	273	312	347	366	394
3621MT No Heat	3.0 Ton	High	1200*	10x10 3/4 [559]	CFM [L/s]	1175 [555]	1200 [566]	1203 [568]	1200 [566]	1200 [566]	1199 [566]	1202 [567]	1200 [566]	1197 [565]	1180 [557]
					RPM	646	740	783	851	911	958	1013	1056	1102	1144
					Watts	147	186	207	240	270	296	334	356	385	416
3821MT with 18 kW Heat	3.0 Ton	High	1200*	10x10 3/4 [559]	CFM [L/s]	1159 [546]	1178 [556]	1176 [555]	1167 [551]	1162 [548]	1155 [545]	1153 [544]	1145 [540]	1137 [537]	1114 [526]
					RPM	680	779	826	899	963	1015	1074	1122	1172	1219
					Watts	168	213	239	278	313	345	388	416	450	487

WARNING: Observe airflow operating limits. Do not operate above 1.0 in. W.C. system external static.
*The airflow for continuous fan is set at 50% of the cooling airflow.

[] Designates Metric Conversions

**Airflow Performance and Electrical Data (Cont.) RH1V**

Model No. RH1V	Tonnage Application	Motor Speed From Factory	Nominal Air-Flow CFM	Blower Size/ Motor HP [W]	ECM										
					CFM Air Delivery/RPM/Watts—230 Volts										
					External Static Pressure—Inches W.C. [kPa]										
					0.1 [.02]	0.2 [.05]	0.3 [.07]	0.4 [.10]	0.5 [.12]	0.6 [.15]	0.7 [.17]	0.8 [.20]	0.9 [.22]	1.0 [.24]	
4821ST No Heat	3.5 Ton	High	1400*	10x10 3/4 [559]	CFM [L/s]	1395 [658]	1404 [663]	1413 [667]	1413 [667]	1411 [666]	1411 [666]	1402 [662]	1391 [656]	1380 [651]	1371 [647]
					RPM	731	807	859	910	968	1016	1057	1100	1128	1158
					Watts	240	273	308	349	383	411	436	468	496	513
4821ST with 20 kW Heat	3.5 Ton	High	1400*	10x10 3/4 [559]	CFM [L/s]	1379 [651]	1382 [652]	1385 [654]	1380 [651]	1372 [648]	1367 [645]	1352 [638]	1336 [631]	1319 [622]	1305 [616]
					RPM	765	846	902	958	1020	1073	1118	1166	1198	1233
					Watts	261	300	340	387	426	460	490	528	561	584
4821ST No Heat	4.0 Ton	High	1600*	10x10 3/4 [559]	CFM [L/s]	1583 [747]	1583 [747]	1583 [747]	1590 [750]	1582 [747]	1566 [739]	1572 [742]	1556 [734]	1547 [730]	1539 [726]
					RPM	826	879	933	984	1025	1067	1119	1148	1176	1219
					Watts	342	375	410	454	486	523	552	585	614	616
4821ST with 25 kW Heat	4.0 Ton	High	1600*	10x10 3/4 [559]	CFM [L/s]	1567 [740]	1559 [736]	1551 [732]	1550 [732]	1534 [724]	1510 [713]	1508 [712]	1484 [700]	1467 [692]	1452 [685]
					RPM	860	919	978	1035	1082	1129	1187	1222	1255	1304
					Watts	363	403	444	495	534	577	613	653	688	697
4824ST No Heat	4.0 Ton	High	1600*	11x11 3/4 [559]	CFM [L/s]	1607 [758]	1615 [762]	1622 [765]	1630 [769]	1637 [773]	1629 [769]	1621 [765]	1614 [762]	1606 [758]	1583 [747]
					RPM	612	698	747	788	835	870	914	950	981	1018
					Watts	225	297	334	359	410	439	469	502	532	568
4824ST with 25 kW Heat	4.0 Ton	High	1600*	11x11 3/4 [559]	CFM [L/s]	1587 [749]	1589 [750]	1589 [750]	1591 [751]	1591 [751]	1577 [744]	1562 [737]	1549 [731]	1534 [724]	1505 [710]
					RPM	658	748	802	847	899	938	987	1027	1063	1104
					Watts	246	325	369	401	459	495	532	572	609	652
6024ST No Heat	5.0 Ton	High	1600*	11x11 3/4 [559]	CFM [L/s]	1607 [758]	1615 [762]	1622 [765]	1630 [769]	1637 [773]	1629 [769]	1621 [765]	1614 [762]	1606 [758]	1583 [747]
					RPM	612	698	747	788	835	870	914	950	981	1018
					Watts	225	297	334	359	410	439	469	502	532	568
6024ST with 25 kW Heat	5.0 Ton	High	1600*	11x11 3/4 [559]	CFM [L/s]	1587 [749]	1589 [750]	1589 [750]	1591 [751]	1591 [751]	1577 [744]	1562 [737]	1549 [731]	1534 [724]	1505 [710]
					RPM	658	748	802	847	899	938	987	1027	1063	1104
					Watts	246	325	369	401	459	495	532	572	609	652
6024ST No Heat	5.0 Ton	High	1800*	11x11 3/4 [559]	CFM [L/s]	1794 [847]	1808 [853]	1808 [853]	1807 [853]	1807 [853]	1807 [853]	1807 [853]	1800 [850]	1786 [843]	1772 [836]
					RPM	676	739	787	840	871	923	950	994	1028	1050
					Watts	330	376	416	465	504	554	576	624	662	694
6024ST with 30 kW Heat	5.0 Ton	High	1800*	11x11 3/4 [559]	CFM [L/s]	1756 [829]	1770 [835]	1770 [835]	1769 [835]	1769 [835]	1769 [835]	1769 [835]	1762 [832]	1748 [825]	1734 [818]
					RPM	713	778	828	884	917	971	1000	1047	1083	1107
					Watts	361	410	453	505	547	600	625	676	717	752

WARNING: Observe airflow operating limits. Do not operate above 1.0 in. W.C. system external static.

*The airflow for continuous fan is set at 50% of the cooling airflow.

Blower Motor Electrical Data RH1V

Model No. RH1V	Voltage	Phase	Hertz	HP [W]	RPM	Speeds	Circuit Amps.	Minimum Circuit Ampacity	Maximum Circuit Protector
2417ST	208/240	1	60	1/3 [249]	300-1100	2	2.8	4.0	15
3617ST	208/240	1	60	1/2 [373]	300-1100	2	4.3	6.0	15
3621MT/4821ST/ 4824ST/6024ST	208/240	1	60	3/4 [559]	300-1100	2	6.8	9.0	15
6024ST	206/240	1	60	3/4 [559]	300-1100	2	4.4	6.0	15

[] Designates Metric Conversions



Electrical Data – With Electric Heat RH1V

Installation of the U.L. Listed original equipment manufacturer provided heater kits listed in the following table is recommended for all auxiliary heating requirements.

Air Handler Model RH1V	Heater Model No.	Heater kW (208/240V)	PH/HZ	No. Elements kW Per	Type Supply Circuit Single Circuit Multiple	Circuit Amps.	Motor Ampacity	Minimum Circuit Ampacity	Maximum Circuit Protector
2417ST	RXBH-1724?03J	2.25/3.0	1/60	1-3.0	SINGLE	10.8/12.5	2.2	17/19	20/20
	RXBH-1724?05J	3.6/4.8	1/60	1-4.8	SINGLE	17.3/20.0	2.2	25/28	25/30
	RXBH-1724?07J	5.4/7.2	1/60	2-3.6	SINGLE	26.0/30.0	2.2	36/41	40/45
	RXBH-1724?10J	7.2/9.6	1/60	2-4.8	SINGLE	34.6/40.0	2.2	46/53	50/60
	RXBH-1724A13J	9.4/12.5	1/60	3/4/17	SINGLE	45.1/52.1	2.2	60/68	60/70
		3.1/4.2	1/60	1/4/17	MULTIPLE CKT 1	15.0/17.4	2.2	22/25	25/25
		6.3/8.3	1/60	2/4/17	MULTIPLE CKT 2	30.1/34.7	0	38/44	40/45
	RXBH-1724A07C	5.4/7.2	3/60	3-2.4	SINGLE	15.0/17.3	2.2	22/25	25/25
RXBH-1724A10C	7.2/9.6	3/60	3-3.2	SINGLE	20.0/23.1	2.2	28/32	30/35	
RXBH-1724A13C	9.4/12.5	3/60	3/4/17	SINGLE	26.1/30.1	2.2	36/41	40/45	
3617ST	RXBH-1724?03J	2.25/3.0	1/60	1-3.0	SINGLE	10.8/12.5	3.1	18/20	20/20
	RXBH-1724?05J	3.6/4.8	1/60	1-4.8	SINGLE	17.3/20.0	3.1	26/29	30/30
	RXBH-1724?07J	5.4/7.2	1/60	2-3.6	SINGLE	26.0/30.0	3.1	37/42	40/45
	RXBH-1724?10J	7.2/9.6	1/60	2-4.8	SINGLE	34.6/40.0	3.1	48/54	50/60
	RXBH-1724A13J	9.4/12.5	1/60	3/4/17	SINGLE	45.1/52.1	3.1	61/69	70/70
		3.1/4.2	1/60	1/4/17	MULTIPLE CKT 1	15.0/17.4	3.1	23/26	25/30
		6.3/8.3	1/60	2/4/17	MULTIPLE CKT 2	30.1/34.7	0	38/44	40/45
	RXBH-1724A15J	10.8/14.4	1/60	3-4.8	SINGLE	51.9/60.0	3.1	69/79	70/80
		3.6/4.8	1/60	1-4.8	MULTIPLE CKT 1	17.3/20.0	3.1	26/29	30/30
		7.2/9.6	1/60	2-4.8	MULTIPLE CKT 2	34.6/40.0	0	44/50	45/50
	RXBH-1724A18J	12.8/17.0	1/60	3/5/68	SINGLE	61.6/70.8	3.1	81/93	90/100
		4.3/5.7	1/60	1/5/68	MULTIPLE CKT 1	20.5/23.6	3.1	30/34	30/35
		8.5/11.3	1/60	2/5/68	MULTIPLE CKT 2	41.1/47.2	0	52/59	60/60
	RXBH-1724A07C	5.4/7.2	3/60	3-2.4	SINGLE	15.0/17.3	3.1	23/26	25/30
	RXBH-1724A10C	7.2/9.6	3/60	3-3.2	SINGLE	20.0/23.1	3.1	29/33	30/35
	RXBH-1724A13C	9.4/12.5	3/60	3/4/17	SINGLE	26.1/30.1	3.1	37/42	40/45
RXBH-1724A15C	10.8/14.4	3/60	3-4.8	SINGLE	30.0/34.6	3.1	42/48	45/50	
RXBH-1724A18C	12.8/17.0	3/60	3/5/68	SINGLE	35.5/41.0	3.1	49/56	50/60	
3821MT 4821ST	RXBH-1724?05J	3.6/4.8	1/60	1-4.8	SINGLE	17.3/20.0	4.0	27/30	30/30
	RXBH-1724?07J	5.4/7.2	1/60	2-3.6	SINGLE	26.0/30.0	4.0	38/43	40/45
	RXBH-1724?10J	7.2/9.6	1/60	2-4.8	SINGLE	34.6/40.0	4.0	49/55	50/60
	RXBH-1724A15J	10.8/14.4	1/60	3-4.8	SINGLE	51.9/60.0	4.0	70/80	70/80
		3.6/4.8	1/60	1-4.8	MULTIPLE CKT 1	17.3/20.0	4.0	27/30	30/30
		7.2/9.6	1/60	2-4.8	MULTIPLE CKT 2	34.6/40.0	0.0	44/50	45/50
	RXBH-1724A18J	12.8/17.0	1/60	4/4/26	SINGLE	61.6/70.8	4.0	82/94	90/100
		6.4/8.5	1/60	2/4/26	MULTIPLE CKT 1	30.8/35.4	4.0	44/50	45/50
		6.4/8.5	1/60	2/4/26	MULTIPLE CKT 2	30.8/35.4	0.0	39/45	40/45
	RXBH-24A20J (3½, 4-ton only)	14.4/19.2	1/60	4-48	SINGLE	69.2/80	4.0	92/105	100/110
		7.2/9.6	1/60	2-4.8	MULTIPLE CKT 1	34.6/40.0	4.0	49/55	50/60
		7.2/9.6	1/60	2-4.8	MULTIPLE CKT 2	34.6/40.0	0.0	44/50	45/50
	RXBH-24A25J (4-ton only)	18.0/24.0	1/60	6-4.0	SINGLE	86.4/99.9	4.0	113/130	125/150
6.0/8.0		1/60	2-4.0	MULTIPLE CKT 1	28.8/33.3	4.0	42/47	45/50	
6.0/8.0		1/60	2-4.0	MULTIPLE CKT 2	28.8/33.3	0.0	36/42	40/45	
	6.0/8.0	1/60	2-4.0	MULTIPLE CKT 3	28.8/33.3	0.0	36/42	40/45	

- Supply circuit protective devices may be fuses or "HACR" type circuit breakers.
- Largest motor load is included in single circuit and multiple circuit 1.
- If non-standard fuse size is specified, use next size larger standard fuse size.
- J Voltage (230V) single phase air handler is designed to be used with single or three phase 230 volt electric heaters. In the case of connecting 3-phase power to the air handler terminal block without the heater, bring only two leads to the terminal block cap, insulate and fully secure the third lead.

[] Designates Metric Conversions

Electrical Data – With Electric Heat RH1V (Cont.)

Installation of the U.L. Listed original equipment manufacturer provided heater kits listed in the following table is recommended for all auxiliary heating requirements.

Air Handler Model RH1V	Heater Model No.	Heater kW (208/240V)	PH/HZ	No. Elements kW Per	Type Supply Circuit Single Circuit Multiple	Circuit Amps.	Motor Ampacity	Minimum Circuit Ampacity	Maximum Circuit Protector
3821MT 4821ST	RXBH-1724A07C	5.4/7.2	3/60	3-2.4	SINGLE	15.0/17.3	4.0	24/27	25/30
	RXBH-1724A10C	7.2/9.6	3/60	3-3.2	SINGLE	20.0/23.1	4.0	30/34	30/35
	RXBH-1724A15C	10.8/14.4	3/60	3-4.8	SINGLE	30.0/34.6	4.0	43/49	45/50
	RXBH-1724A18C	12.8/17.0	3/60	3/2/84	SINGLE	35.6/41.0	4.0	50/57	50/60
	RXBH-24A20C* (3 1/2, 4-ton only)	14.4/19.2	3/60	3-3.2	SINGLE	40.0/46.2	4.0	55/63	60/70
		7.2/9.6	3/60	3-3.2	MULTIPLE CKT 1	20.0/23.1	4.0	30/34	30/35
		7.2/9.6	3/60	3-3.2	MULTIPLE CKT 2	20.0/23.1	0.0	25/29	25/30
	RXBH-24A25C* (4-ton only)	18.0/24.0	3/60	6-4.0	SINGLE	50.0/57.8	4.0	68/78	70/80
		9.0/12.0	3/60	3-4.0	MULTIPLE CKT 1	25.0/28.9	4.0	37/42	40/45
		9.0/12.0	3/60	3-4.0	MULTIPLE CKT 2	25.0/28.9	0.0	32/37	35/40
4824ST 6024ST	RXBH-1724705J	3.6/4.8	1/60	1-4.8	SINGLE	17.3/20.0	4.4	28/31	30/35
	RXBH-1724707J	5.4/7.2	1/60	2-3.6	SINGLE	26.0/30.0	4.4	38/43	40/45
	RXBH-1724710J	7.2/9.6	1/60	2-4.8	SINGLE	34.6/40.0	4.4	49/56	50/60
	RXBH-1724A15J	10.8/14.4	1/60	3-4.8	SINGLE	51.9/60.0	4.4	71/81	80/90
		3.6/4.8	1/60	1-4.8	MULTIPLE CKT1	17.3/20.0	4.4	28/31	30/35
	RXBH-1724A18J	7.2/9.6	1/60	2-4.8	MULTIPLE CKT 2	34.6/40.0	0	44/50	45/50
		12/8/17	1/60	4/4/26	SINGLE	61.6/70.8	4.4	83/94	90/100
	RXBH-1724A18J	6.4/8.5	1/60	2/4/26	MULTIPLE CKT 1	30.8/35.4	4.4	44/50	45/50
		6.4/8.5	1/60	2/4/26	MULTIPLE CKT 2	30.8/35.4	0	39/45	40/45
	RXBH-24A20J	14.4/19.2	1/60	4-4.8	SINGLE	69.2/80	4.4	93/106	100/110
		7.2/9.6	1/60	2-4.8	MULTIPLE CKT 1	34.6/40.0	4.4	49/56	50/60
		7.2/9.6	1/60	2-4.8	MULTIPLE CKT 2	34.6/40.0	0	44/50	45/50
	RXBH-24A25J	18.0/24.0	1/60	6-4.0	SINGLE	86.4/99.9	4.4	114/131	125/150
		6.0/8.0	1/60	2-4.0	MULTIPLE CKT 1	28.8/33.3	4.4	42/48	45/50
		6.0/8.0	1/60	2-4.0	MULTIPLE CKT 2	28.8/33.3	0	36/42	40/45
		6.0/8.0	1/60	2-4.0	MULTIPLE CKT 3	28.8/33.3	0	36/42	40/45
	RXBH-24A30J (1800 CFM only)	21.6/28.8	1/60	6-4.8	SINGLE	103.8/120.	4.4	136/156	150/175
	RXBH-24A30J (5-ton only) (1800 CFM only)	7.2/9.6	1/60	2-4.8	MULTIPLE CKT 1	34.6/40.0	4.4	49/56	50/60
		7.2/9.6	1/60	2-4.8	MULTIPLE CKT 2	34.6/40.0	0	44/50	45/50
		7.2/9.6	1/60	2-4.8	MULTIPLE CKT 3	34.6/40.0	0	44/50	45/50
	RXBH-1724A07C	5.4/7.2	3/60	3-2.4	SINGLE	15.0/17.3	4.4	25/28	25/30
	RXBH-1724A10C	7.2/9.6	3/60	3-3.2	SINGLE	20.0/23.1	4.4	31/35	35/35
	RXBH-1724A15C	10.8/14.4	3/60	3-4.8	SINGLE	30.0/34.6	4.4	43/49	45/50
	RXBH-1724A18C	12.8/17.0	3/60	3/2/84	SINGLE	35.6/41.0	4.4	50/57	50/60
	RXBH-24A20C*	14.4/19.2	3/60	3-3.2	SINGLE	40.0/46.2	4.4	56/64	60/70
		7.2/9.6	3/60	3-3.2	MULTIPLE CKT 1	20.0/23.1	4.4	31/35	35/35
		7.2/9.6	3/60	3-3.2	MULTIPLE CKT 2	20.0/23.1	0	25/29	25/30
	RXBH-24A25C*	18.0/24.0	3/60	6-4.0	SINGLE	50.0/57.8	4.4	68/78	70/80
		9.0/12.0	3/60	3-4.0	MULTIPLE CKT 1	25.0/28.9	4.4	37/42	40/45
		9.0/12.0	3/60	3-4.0	MULTIPLE CKT 2	25.0/28.9	0	32/37	35/40
RXBH-24A30C* (1800 CFM only)	21.6/28.8	3/60	6-4.8	SINGLE	60.0/69.4	4.4	81/93	90/100	
RXBH-24A30C (5-ton only) (1800 CFM only)	10.8/14.4	3/60	3-4.8	MULTIPLE CKT 1	30.0/34.7	4.4	43/50	45/50	
	10.8/14.4	3/60	3-4.8	MULTIPLE CKT 2	30.0/34.7	0	38/44	40/45	

- Supply circuit protective devices may be fuses or "HACR" type circuit breakers.
- Largest motor load is included in single circuit and multiple circuit 1.
- If non-standard fuse size is specified, use next size larger standard fuse size.
- J Voltage (230V) single phase air handler is designed to be used with single or three phase 230 volt electric heaters. In the case of connecting 3-phase power to the air handler terminal block without the heater, bring only two leads to the terminal block cap, insulate and fully secure the third lead.

[] Designates Metric Conversions



Airflow Performance

Airflow performance data is based on cooling performance with a coil and no filter in place. Select performance table for appropriate unit size, voltage and number of electric heaters to be used. Make sure external static applied to unit allows operation within the minimum and maximum limits shown in table

below for both cooling and electric heat operation. For optimum blower performance, operate the unit in the .3 [8 mm] to .7 inches [18 mm] W.C. external static range. Units with coils should be applied with a minimum of .1 inch [3 mm] W.C. external static range.

Airflow Performance Data RH2V

Air Handler RH2V	Outdoor Unit	Cabinet Size	Blower		Nominal Airflow CFM	External Static Pressure - In. W.C. CFM [L/s] Air Delivery/RPM/Watts-230 Volts												
			Size Motor HP	Unit Operation		External Static Pressure - Inches W.C. [kPa]												
						0.10	0.20	0.30	0.40	0.50	0.60	0.70	0.80	0.90	1.00			
2421HT	RARL-024 or RASL-024	21	10 x 8 1/3	First Stage	600	CFM	550 [260]	575 [271]	600 [283]	600 [283]	625 [295]	625 [295]	625 [295]	600 [283]	575 [271]	550 [260]		
						RPM	455	540	620	695	760	825	885	940	985	1030		
						Watts	40	55	70	85	105	120	135	150	170	185		
				Second Stage	775	CFM	775 [366]	775 [366]	775 [366]	800 [378]	800 [378]	825 [389]	825 [389]	825 [389]	825 [389]	825 [389]	825 [389]	825 [389]
						RPM	540	615	685	750	810	870	925	975	1020	1065		
						Watts	70	90	115	135	160	180	205	225	250	270		
3624HT	RARL-036 or RASL-036	24	11 x 11 3/4	First Stage	950	CFM	950 [448]	950 [448]	1000 [472]	975 [460]	975 [460]	975 [460]	925 [437]	925 [437]	925 [437]	925 [437]		
						RPM	495	555	610	665	720	770	820	865	910	955		
						Watts	95	115	140	165	185	210	240	265	290	320		
				Second Stage	1175	CFM	1150 [543]	1150 [543]	1175 [555]	1175 [555]	1175 [555]	1150 [543]	1150 [543]	1150 [543]	1125 [531]	1125 [531]	1125 [531]	
						RPM	550	600	650	700	750	800	850	900	925	975		
						Watts	125	175	200	225	250	275	300	325	375	400		
	RASL-039	First Stage	825	CFM	825 [389]	825 [389]	875 [413]	875 [413]	850 [401]	850 [401]	825 [389]	825 [389]	800 [378]	800 [378]				
				RPM	455	515	575	630	680	730	780	830	875	915				
				Watts	70	90	115	135	155	180	205	230	255	280				
		Second Stage	1175	CFM	1150 [543]	1150 [543]	1175 [555]	1175 [555]	1175 [555]	1150 [543]	1150 [543]	1150 [543]	1125 [531]	1125 [531]				
				RPM	550	600	650	700	750	800	850	900	925	975				
				Watts	125	175	200	225	250	275	300	325	375	400				
4824HT	RARL-048	24	11 x 11 3/4	First Stage	1200	CFM	1275 [602]	1275 [602]	1250 [590]	1250 [590]	1275 [602]	1250 [590]	1250 [590]	1225 [578]	1225 [578]	1225 [578]		
						RPM	533	593	649	702	752	798	841	881	917	950		
						Watts	131	161	191	221	250	279	307	335	363	390		
				Second Stage	1600	CFM	1650 [779]	1650 [779]	1675 [791]	1700 [802]	1700 [802]	1700 [802]	1675 [791]	1675 [791]	1675 [791]	1675 [791]		
						RPM	635	698	761	824	887	950	1013	1075	1120	1006		
						Watts	244	293	340	384	425	464	500	533	564	592		
	RASL-048	First Stage	1000	CFM	1000 [472]	1000 [472]	1025 [484]	1025 [484]	1000 [472]	1000 [472]	975 [460]	975 [460]	975 [460]	975 [460]				
				RPM	500	575	625	675	725	775	825	875	925	950				
				Watts	100	125	150	175	200	225	250	275	300	325				
		Second Stage	1600	CFM	1650 [779]	1650 [779]	1675 [791]	1700 [802]	1700 [802]	1700 [802]	1675 [791]	1675 [791]	1675 [791]	1675 [791]				
				RPM	635	698	761	824	887	950	1013	1075	1120	1006				
				Watts	244	293	340	384	425	464	500	533	564	592				
6024HT	RARL-060	24	11 x 11 3/4	First Stage	1275	CFM	1275 [602]	1275 [602]	1275 [602]	1275 [602]	1275 [602]	1275 [602]	1250 [590]	1250 [590]	1250 [590]			
						RPM	577	633	687	738	786	831	874	914	951	986		
						Watts	159	189	218	248	279	310	341	372	404	436		
				Second Stage	1700	CFM	1625 [767]	1625 [767]	1650 [779]	1675 [791]	1675 [791]	1650 [779]	1650 [779]	1625 [767]	1625 [767]	1625 [767]		
						RPM	691	742	790	835	877	916	953	986	1016	1044		
						Watts	289	334	377	417	456	493	529	562	593	623		
	RASL-060	First Stage	1050	CFM	1050 [496]	1050 [496]	1075 [507]	1075 [507]	1050 [496]	1025 [484]	1025 [484]	1025 [484]	1025 [484]	1000 [472]				
				RPM	525	575	625	675	750	800	825	875	925	975				
				Watts	100	125	150	175	225	250	275	300	325	350				
		Second Stage	1700	CFM	1625 [767]	1625 [767]	1650 [779]	1675 [791]	1675 [791]	1650 [779]	1650 [779]	1625 [767]	1625 [767]	1625 [767]				
				RPM	691	742	790	835	877	916	953	986	1016	1044				
				Watts	289	334	377	417	456	493	529	562	593	623				

IMPORTANT: Observe airflow operating limits. Do not operate above 1.0 in. W.C. system external static.

[] Designates Metric Conversions



Electrical Data (-)H2V

Model RH2V	HP [W]	Voltage	Phase	Hertz	RPM	Circuit Amps.	Minimum Circuit Ampacity	Maximum Circuit Protector
2421HT	1/3 [249]	208/230	1	60	300-1100	1.7	4.0	15
3624HT	3/4 [559]	208/230	1	60	300-1100	4.9	9.0	15
4824HT	3/4 [559]	208/230	1	60	300-1100	4.9	9.0	15
6024HT	3/4 [559]	208/230	1	60	300-1100	4.9	9.0	15

Electrical Data – With Electric Heat RH2V

Installation of the U.L. Listed original equipment manufacturer provided heater kits listed in the following table is recommended for all auxiliary heating requirements.

Air Handler Model RH2V	Heater Model No.	Heater kW (208/240V)	PH/HZ	No. Elements kW Per	Type Supply Circuit Single Circuit Multiple	Circuit Amps.	Motor Ampacity	Minimum Circuit Ampacity	Maximum Circuit Protection
2421HT	RXBH-1724?05J	3.6/4.8	1/60	1 - 4.8	SINGLE	17.3/20.0	1.7	24/28	25/30
	RXBH-1724?07J	5.4/7.2	1/60	2 - 3.6	SINGLE	26.0/30.0	1.7	35/40	35/40
	RXBH-1724?10J	7.2/9.6	1/60	2 - 4.8	SINGLE	34.6/40.0	1.7	46/53	50/60
3624HT	RXBH-1724?05J	3.6/4.8	1/60	1 - 4.8	SINGLE	17.3/20.0	4.9	28/32	30/35
	RXBH-1724?07J	5.4/7.2	1/60	2 - 3.6	SINGLE	26.0/30.0	4.9	39/44	40/45
	RXBH-1724?10J	7.2/9.6	1/60	2 - 4.8	SINGLE	34.6/40.0	4.9	50/57	50/60
	RXBH-1724A13J	9.4/12.5	1/60	3-4.17	SINGLE	45.1/52.1	4.9	63/72	70/80
	RXBH-1724A13J	3.1/4.2	1/60	1-4.17	MULTIPLE CKT 1	15.0/17.4	4.9	25/28	25/30
		6.3/8.3	1/60	2-4.17	MULTIPLE CKT 2	30.1/34.7	0.0	38/44	40/45
	RXBH-1724A15J	10.8/14.4	1/60	3-4.8	SINGLE	51.9/60.0	4.9	71/82	80/90
	RXBH-1724A15J	3.6/4.8	1/60	1 - 4.8	MULTIPLE CKT 1	17.3/20.0	4.9	28/32	30/35
		7.2/9.6	1/60	2 - 4.8	MULTIPLE CKT 2	34.6/40.0	0.0	44/50	45/50
	RXBH-1724A18J	12.8/17	1/60	3-5.68	SINGLE	61.6/70.8	4.9	84/95	90/100
	RXBH-1724A18J	4.3/5.7	1/60	1 - 5.68	MULTIPLE CKT 1	20.5/23.6	4.9	32/36	35/40
		8.7/11.3	1/60	2 - 5.86	MULTIPLE CKT 2	41.1/47.2	0.0	52/59	60/60
	RXBH-24A20J	14.4/19.2	1/60	4-4.8	SINGLE	69.2/80	4.9	93/107	100/110
	RXBH-24A20J	7.2/9.6	1/60	2 - 4.8	MULTIPLE CKT 1	34.6/40.0	4.9	50/57	50/60
		7.2/9.6	1/60	2 - 4.8	MULTIPLE CKT 2	34.6/40.0	0.0	44/50	45/50
4824HT	RXBH-1724?05J	3.6/4.8	1/60	1 - 4.8	SINGLE	17.3/20.0	4.9	28/32	30/35
	RXBH-1724?07J	5.4/7.2	1/60	2 - 3.6	SINGLE	26.0/30.0	4.9	39/44	40/45
	RXBH-1724?10J	7.2/9.6	1/60	2 - 4.8	SINGLE	34.6/40.0	4.9	50/57	50/60
	RXBH-1724A13J	9.4/12.5	1/60	3-4.17	SINGLE	45.1/52.1	4.9	63/72	70/80
	RXBH-1724A13J	3.1/4.2	1/60	1-4.17	MULTIPLE CKT 1	15.0/17.4	4.9	25/28	25/30
		6.3/8.3	1/60	2-4.17	MULTIPLE CKT 2	30.1/34.7	0.0	38/44	40/45
	RXBH-1724A15J	10.8/14.4	1/60	3-4.8	SINGLE	51.9/60.0	4.9	71/82	80/90
	RXBH-1724A15J	3.6/4.8	1/60	1 - 4.8	MULTIPLE CKT 1	17.3/20.0	4.9	28/32	30/35
		7.2/9.6	1/60	2 - 4.8	MULTIPLE CKT 2	34.6/40.0	0.0	44/50	45/50
	RXBH-1724A18J	12.8/17	1/60	3-5.68	SINGLE	61.6/70.8	4.9	84/95	90/100
	RXBH-1724A18J	4.3/5.7	1/60	1 - 5.68	MULTIPLE CKT 1	20.5/23.6	4.9	32/36	35/40
		8.7/11.3	1/60	2 - 5.86	MULTIPLE CKT 2	41.1/47.2	0.0	52/59	60/60
	RXBH-24A20J	14.4/19.2	1/60	4-4.8	SINGLE	69.2/80	4.9	93/107	100/110
	RXBH-24A20J	7.2/9.6	1/60	2 - 4.8	MULTIPLE CKT 1	34.6/40.0	4.9	50/57	50/60
		7.2/9.6	1/60	2 - 4.8	MULTIPLE CKT 2	34.6/40.0	0.0	44/50	45/50
RXBH-24A25J (4-ton only)	18.0/24.0	1/60	6-4.0	SINGLE	86.4/99.9	5.2	115/132	125/150	
RXBH-24A25J (4-ton only)	6.0/8.0	1/60	2-4.0	MULTIPLE CKT 1	28.8/33.3	5.2	43/49	45/50	
	6.0/8.0	1/60	2-4.0	MULTIPLE CKT 2	28.8/33.3	0.0	36/42	40/45	
	6.0/8.0	1/60	2-4.0	MULTIPLE CKT 3	28.8/33.3	0.0	36/42	40/45	

- Supply circuit protective devices may be fuses or "HACR" type circuit breakers.
- Largest motor load is included in single circuit and multiple circuit 1.
- If non-standard fuse size is specified, use next size larger standard fuse size.
- J Voltage (230V) single phase air handler is designed to be used with single or three phase 230 volt electric heaters. In the case of connecting 3-phase power to the air handler terminal block without the heater, bring only two leads to the terminal block cap, insulate and fully secure the third lead.

[] Designates Metric Conversions



Electrical Data – With Electric Heat RH2V (con't.)

Installation of the U.L. Listed original equipment manufacturer provided heater kits listed in the following table is recommended for all auxiliary heating requirements.

Air Handler Model RH2V	Heater Model No.	Heater kW (208/240V)	PH/HZ	No. Elements kW Per	Type Supply Circuit Single Circuit Multiple	Circuit Amps.	Motor Ampacity	Minimum Circuit Ampacity	Maximum Circuit Protection
6024HT	RXBH-1724?07J	5.4/7.2	1/60	2 - 3.6	SINGLE	26.0/30.0	4.9	39/44	40/45
	RXBH-1724?10J	7.2/9.6	1/60	2 - 4.8	SINGLE	34.6/40.0	4.9	50/57	50/60
	RXBH-1724A15J	10.8/14.4	1/60	3-4.8	SINGLE	51.9/60.0	4.9	71/82	80/90
	RXBH-1724A15J	3.6/4.8	1/60	1 - 4.8	MULTIPLE CKT 1	17.3/20.0	4.9	28/32	30/35
		7.2/9.6	1/60	2 - 4.8	MULTIPLE CKT 2	34.6/40.0	0.0	44/50	45/50
	RXBH-1724A18J	12.8/17	1/60	3-5.68	SINGLE	61.6/70.8	4.9	84/95	90/100
	RXBH-1724A18J	4.3/5.7	1/60	1 - 5.68	MULTIPLE CKT 1	20.5/23.6	4.9	32/36	35/40
		8.7/11.3	1/60	2 - 5.86	MULTIPLE CKT 2	41.1/47.2	0.0	52/59	60/60
	RXBH-24A20J	14.4/19.2	1/60	4-4.8	SINGLE	69.2/80	4.9	93/107	100/110
	RXBH-24A20J	7.2/9.6	1/60	2 - 4.8	MULTIPLE CKT 1	34.6/40.0	4.9	50/57	50/60
		7.2/9.6	1/60	2 - 4.8	MULTIPLE CKT 2	34.6/40.0	0.0	44/50	45/50
	RXBH-24A25J	18.0/24.0	1/60	6-4.0	SINGLE	86.4/99.9	4.9	115/131	125/150
	RXBH-24A25J	6.0/8.0	1/60	2-4.0	MULTIPLE CKT 1	28.8/33.3	4.9	43/48	45/50
		6.0/8.0	1/60	2-4.0	MULTIPLE CKT 2	28.8/33.3	0.0	36/42	40/45
		6.0/8.0	1/60	2-4.0	MULTIPLE CKT 3	28.8/33.3	0.0	36/42	40/45
	RXBH-24A20J	14.4/19.2	1/60	4-4.8	SINGLE	69.2/80	4.9	93/107	100/110
	RXBH-24A20J	7.2/9.6	1/60	2 - 4.8	MULTIPLE CKT 1	34.6/40.0	4.9	50/57	50/60
		7.2/9.6	1/60	2 - 4.8	MULTIPLE CKT 2	34.6/40.0	0.0	44/50	45/50
	RXBH-24A25J	18.0/24.0	1/60	6-4.0	SINGLE	86.4/99.9	4.9	115/131	125/150
	RXBH-24A25J	6.0/8.0	1/60	2-4.0	MULTIPLE CKT 1	28.8/33.3	4.9	43/48	45/50
		6.0/8.0	1/60	2-4.0	MULTIPLE CKT 2	28.8/33.3	0.0	36/42	40/45
		6.0/8.0	1/60	2-4.0	MULTIPLE CKT 3	28.8/33.3	0.0	36/42	40/45
	RXBH-24A30J	21.6/28.8	1/60	6-4.8	SINGLE	103.8/120	4.9	136/156	150/175
	RXBH-24A30J	7.2/9.6	1/60	2-4.8	MULTIPLE CKT 1	34.6/40.0	4.9	50/57	50/60
7.2/9.6		1/60	2-4.8	MULTIPLE CKT 2	34.6/40.0	0.0	44/50	45/50	
7.2/9.6		1/60	2-4.8	MULTIPLE CKT 3	34.6/40.0	0.0	44/50	45/50	

- Supply circuit protective devices may be fuses or "HACR" type circuit breakers.
- Largest motor load is included in single circuit and multiple circuit 1.
- If non-standard fuse size is specified, use next size larger standard fuse size.
- J Voltage (230V) single phase air handler is designed to be used with single or three phase 230 volt electric heaters. In the case of connecting 3-phase power to the air handler terminal block without the heater, bring only two leads to the terminal block cap, insulate and fully secure the third lead.

[] Designates Metric Conversions

Electrical Wiring

Power Wiring

- Field wiring must comply with the National Electrical Code (C.E.C. in Canada) and any applicable local ordinance.
- Supply wiring must be 75°C minimum copper conductors only.
- See electrical data for product Ampacity rating and Circuit Protector requirement.

Accessories

• Combustible Floor Base RXHB-

Model Cabinet Size	Combustible Floor Base Model Number
17	RXHB-17
21	RXHB-21
24	RXHB-24

- **Jumper Bar Kit 3 Ckt. to 1 Ckt. RXBJ-A31** is used to convert single phase multiple three circuit units to a single supply circuit. Kit includes cover and screw for line side terminals.

- **Jumper Bar Kit 2 Ckt. to 1 Ckt. RXBJ-A21** is used to convert single phase multiple two circuit units to a single supply circuit. Kit includes cover and screw for line side terminals.

- **Note:** No jumper bar kit is available to convert three phase multiple two circuit units to a single supply circuit.

• Auxiliary Horizontal Overflow Pan Accessory RXBM-

Nominal Cooling Capacity-Tons	Auxiliary Horizontal Overflow Pan Accessory Model Number
1½ - 3	RXBM-AC48
3½ - 5	RXBM-AC61

• External Filter Rack RXHF-B17, B21, B24

Model Cabinet Size	Filter Size In. [mm]	Part Number*	A	B
17	16 x 20 [406 x 508]	RXHF-B17	16.90	20.77
21	20 x 20 [508 x 508]	RXHF-B21	20.40	20.77
24	25 x 20 [635 x 508]	RXHF-B24	25.00	21.04

*Accommodates 1" filter

[] Designates Metric Conversions

Grounding

- This product must be sufficiently grounded in accordance with National Electrical Code (C.E.C. in Canada) and any applicable local ordinance.
- A grounding lug is provided.

• Auxiliary Electric Heater Kits RXBH-

Heater Kits include circuit breakers which meet UL and cUL requirements for service disconnect. See the Electric Heat Electrical Data in this specification sheet for specific Heater Kit Model numbers.

• External Filter Base RXHF-

Model Cabinet Size	Filter Size In. [mm]	Part Number*	A	B
21	20 x 20 [508 x 508]	RXHF-21	19.20	21.0
24	25 x 20 [635 x 508]	RXHF-24	22.70	25.5

*Accommodates 1" or 2" filter

• Horizontal Adapter Kit RXHH-

This horizontal adapter kit is used to convert Upflow/Downflow only models to horizontal flow. See the following table to order proper horizontal adapter kit.

Coil Model	Horizontal Adapter Kit Model Number (Single Qty.)	Horizontal Adapter Kit Model Number (10-Pack Qty.)
2414	RXHH-A01	RXHH-A01 x 10
2417	RXHH-A02	RXHH-A02 x 10
3617/3621	RXHH-A03	RXHH-A03 x 10
3821/4821/4824	RXHH-A04	RXHH-A04 x 10
6024	RXHH-A05	RXHH-A05 x 10

• External Filter Base RXHF-

Model Cabinet Size	Filter Size In. [mm]	Part Number*	A	B
17	16 x 20 [406 x 508]	RXHF-17	15.70	17.5
21	20 x 20 [508 x 508]	RXHF-21	19.20	21.0
24	25 x 20 [635 x 508]	RXHF-24	22.70	25.5

*Accommodates 1" or 2" filter

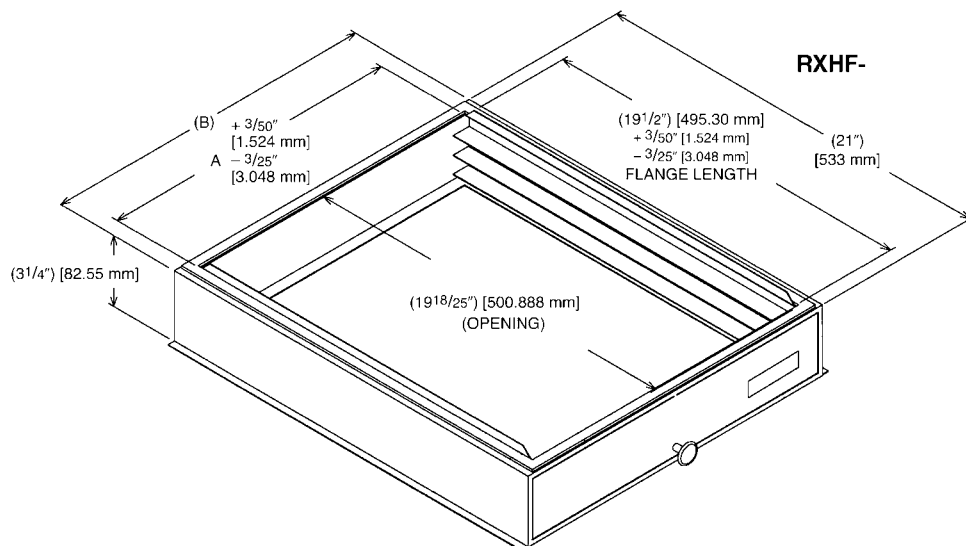
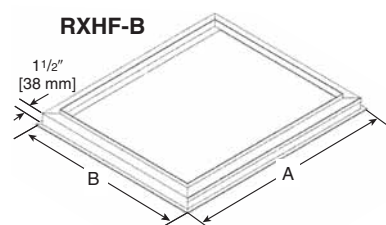

GENERAL TERMS OF LIMITED WARRANTY*

Rheem will furnish a replacement for any part of this product which fails in normal use and service within the applicable periods stated, in accordance with the terms of the limited warranty.

Conditional Parts (Registration Required)Ten (10) Years

***For complete details of the Limited and Conditional Warranties, including applicable terms and conditions, contact your local contractor or the Manufacturer for a copy of the product warranty certificate.**



The new degree of comfort.™

In keeping with its policy of continuous progress and product improvement, Rheem reserves the right to make changes without notice.

Rheem Heating, Cooling & Water Heating • P.O. Box 17010
Fort Smith, Arkansas 72917 • www.rheem.com

Rheem Canada Ltd./Ltée • 125 Edgeware Road, Unit 1
Brampton, Ontario • L6Y 0P5



INTEGRATED HOME COMFORT

PRINTED IN U.S.A 4/14 QG FORM NO. H11-554