



The new degree of comfort.™

# SUBMITTAL COVER SHEET

PROJECT NAME \_\_\_\_\_

LOCATION \_\_\_\_\_

ARCHITECT \_\_\_\_\_

ENGINEER \_\_\_\_\_

CONTRACTOR \_\_\_\_\_

SUBMITTED BY \_\_\_\_\_ DATE \_\_\_\_\_

## UNIT SUMMARY

Quantity						
Unit Designation						
Model No.						
Total Cooling						
Sensible Cooling						
Air Ent. Evaporator						
Air Lvg. Evaporator						
Heating Input						
Heating Output						
CFM/ESP						
EER/SEER						
Electrical						
Minimum Ampacity						
Min.-Max. Breaker						
Net Unit Weight						
Accessory						
Catalog Form Number						

**ACCESSORIES:**

**NOTES:**



INTEGRATED HOME COMFORT

# UPFLOW/HORIZONTAL GAS FURNACE

## R801C Series

80% A.F.U.E.†

Input Rates 50 to 125 kBtu [14.7 to 36 kW]

JOB NAME \_\_\_\_\_ MODEL NO. \_\_\_\_\_

CONTRACTOR \_\_\_\_\_ OUTDOOR UNIT MODEL NO. \_\_\_\_\_

ENGINEER \_\_\_\_\_ LOCATION \_\_\_\_\_

SUBMITTED FOR  APPROVAL  RECORD ORDER NO. \_\_\_\_\_

DATE \_\_\_\_\_

### UNIT DATA

#### HEATING PERFORMANCE

TOTAL CAPACITY INPUT\* ..... MBH [kW]  
 TOTAL CAPACITY OUTPUT\* ..... MBH [kW]  
 DESIGN TEMP. RISE ..... °F [°C] DB  
 AFUE ..... %  
 CALIFORNIA SEASONAL EFFICIENCY ..... %  
(\*uses blower motor heat)

#### SUPPLY AIR BLOWER PERFORMANCE

TOTAL AIR SUPPLY ..... CFM [L/s]  
 TOTAL RESISTANCE EXTERNAL TO UNIT ..... IWG  
 BLOWER SPEED ..... RPM  
 POWER OUTPUT REQUIREMENT .... BHP  
 MOTOR RATING ..... HP [W]  
 POWER INPUT REQUIREMENT ..... kW

#### ELECTRICAL DATA

POWER SUPPLY ..... Hz  
 TOTAL UNIT AMPACITY ..... AMPS  
 MINIMUM WIRE SIZE ..... AWG  
 MAXIMUM OVERCURRENT DEVICE FUSES/HACR BREAKER ..... AMPS

### FEATURES FOR R801C UPFLOW/HORIZONTAL

- 80% residential Gas Furnace CSA certified
- 3 way multi poise design UF / HZ
- PlusOne™ Diagnostics – 7 Segment LED all units
- PlusOne™ Ignition System – DSI for reliability and longevity
- Heat exchanger is removable for improved serviceability. Aluminized steel construction provides maximum corrosion resistance and thermal fatigue reliability.
- Solid doors provide quiet operation
- Low profile 34" cabinet ideal for space constrained installations
- Blower shelf design – serviceable in all furnace orientations
- Hemmed edges on cabinets and doors
- 1/4 turn door knobs for tool less access
- Integrated Control board features dip switches for easy system set up
- QR code for quick access to product information from your smart phone or tablet
- Constant Torque electrically commutated motor

### FIELD INSTALLED ACCESSORIES

- External Bottom Filter Rack RXGF-CB .....
- External Side Filter Rack RXGF-CD .....
- Indoor Coil Casing RXBC-D14A1 .....
- Indoor Coil Casing RXBC-D17A1 .....
- Indoor Coil Casing RXBC-D21A1 .....
- Indoor Coil Casing RXBC-D21B1 .....
- Indoor Coil Casing RXBC-D24A1 .....
- Solid Bottom Kit RXGB-D14 .....
- Solid Bottom Kit RXGB-D17 .....
- Solid Bottom Kit RXGB-D21 .....
- Solid Bottom Kit RXGB-D24 .....
- 4" Flue Adapter RXGW-C01 .....



# Horizontal Application

## WARNING

THIS FURNACE IS NOT APPROVED OR RECOMMENDED FOR INSTALLATION ON ITS BACK, WITH ACCESS DOORS FACING UPWARDS.

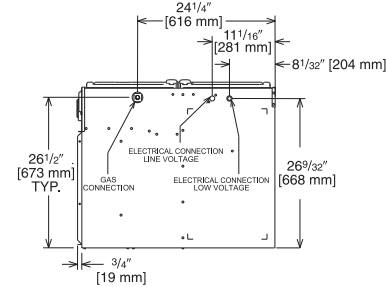
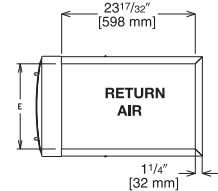
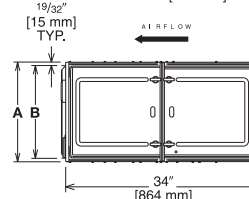
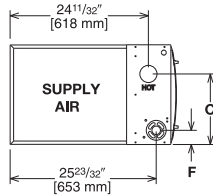
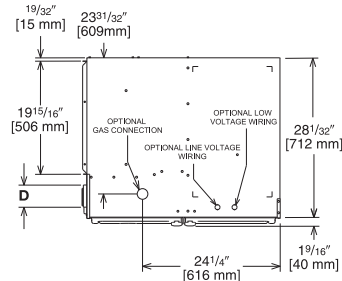

## Upflow Application

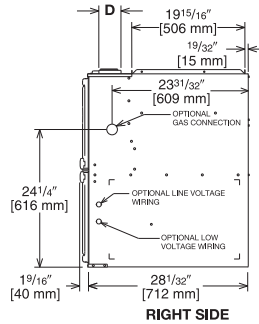
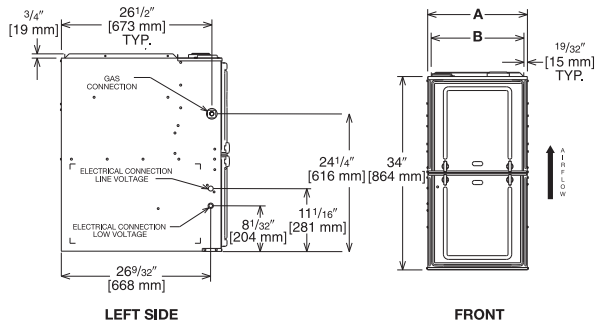
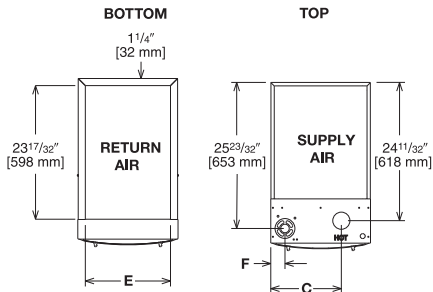

Illustration ST-A1220-04-00 FIGURE 2

## Unit Dimensions

MODEL R801C-	A	B	C	D	E	F	REDUCED CLEARANCE (IN.) [mm]						SHIP WGTS. (LBS.) [kg]
							LEFT SIDE	RIGHT SIDE	BACK	TOP	FRONT	VENT	
050	14 [356]	12 <sup>27</sup> / <sub>32</sub> [326]	10 <sup>5</sup> / <sub>8</sub> [270]	①	11 <sup>1</sup> / <sub>2</sub> [292]	1 <sup>7</sup> / <sub>8</sub> [48]	0	4 [102] ②	0	1 [25]	3 [76]	6 [152] ③	110 [50]
075417	17 <sup>1</sup> / <sub>2</sub> [445]	16 <sup>11</sup> / <sub>32</sub> [415]	12 <sup>3</sup> / <sub>8</sub> [314]	①	15 [381]	2 <sup>1</sup> / <sub>2</sub> [64]	0	3 [76] ②	0	1 [25]	3 [76]	6 [152] ③	125 [57]
075421/100	21 [533]	19 <sup>27</sup> / <sub>32</sub> [504]	14 <sup>1</sup> / <sub>8</sub> [359]	①	18 <sup>1</sup> / <sub>2</sub> [470]	2 <sup>1</sup> / <sub>2</sub> [64]	0	0	0	1 [25]	3 [76]	6 [152] ③	140 [64]
125	24 <sup>1</sup> / <sub>2</sub> [622]	23 <sup>11</sup> / <sub>32</sub> [593]	15 <sup>7</sup> / <sub>8</sub> [403]	①	22 [559]	2 <sup>1</sup> / <sub>2</sub> [64]	0	0	0	1 [25]	3 [76]	6 [152] ③	150 [68]

NOTES: ① May require a 3" [76 mm] to 4" [102 mm] or 3" [76 mm] to 5" [127 mm] adapter. 4" adapter included with (-)801P units.

② May be 0" [0 mm] with type B vent.

③ May be 1" [25 mm] with type B vent.

Furnaces must be vented in accordance with the National Fuel Gas Code, ANSI Z223.1 and in accordance with local codes.

[ ] Designates Metric Conversions

Before proceeding with installation, refer to installation instructions packaged with each model, as well as complying with all Federal, State, Provincial, and Local codes, regulations, and practices.

Rheem Sales Company, Inc.  
5600 Old Greenwood Road, Fort Smith, AR 72908

"In keeping with its policy of continuous progress and product improvement, Rheem reserves the right to make changes without notice."