

Use & Care Manual

With Installation Instructions for the Installer

Electric Residential Hybrid

Water Heaters

Residential - HB Duct Ready Series

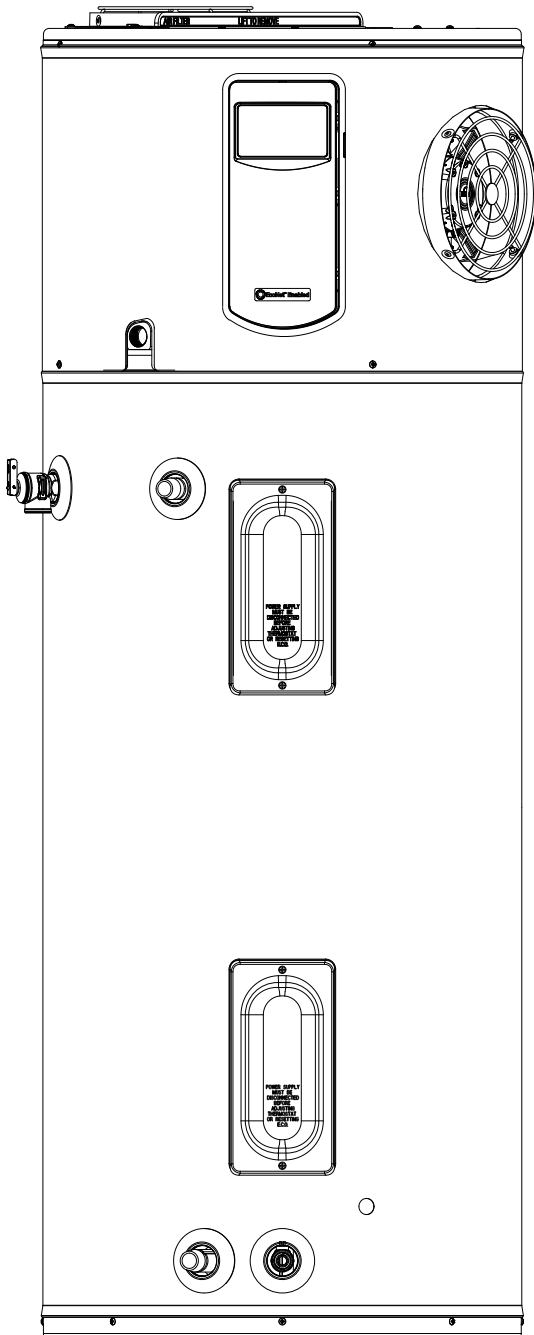



The purpose of this manual is twofold: one, to provide the installer with the basic directions and recommendations for the proper installation and adjustment of the water heater; and two, for the owner-operator, to explain the features, operation, safety precautions, maintenance and troubleshooting of the water heater. This manual also includes a parts list.

It is imperative that all persons who are expected to install, operate or adjust this water heater read the instructions carefully so they may understand how to perform these operations. If you do not understand these instructions or any terms within it, seek professional advice.

Any questions regarding the operation, maintenance, service or warranty of this water heater should be directed to the seller from whom it was purchased. If additional information is required, refer to the section on "If you need service."

DO NOT destroy this manual. Please read carefully and keep in a safe place for future reference.

 **Recognize this symbol as an indication of Important Safety Information!**

 **California Proposition 65 Warning:** This product contains chemicals known to the State of California to cause cancer, birth defects or other reproductive harm.



Safety Information

Safety Precautions 3-4

Installation Instructions

Location 5

Installing the Water Heater . . 6

Water Connections 7

Condensate Drain 7

Relief Valve 8

Electrical Connections 9

Pipe Insulation 11

Ducting Requirements 12

Installation Checklist 14

Operating Instructions

Safety Controls 16

Water Temperature 16

Basic Water Heater Operation .
. 17-24

Care and Cleaning

Draining 25

Maintenance 25

Extended Shut-Down 26

Troubleshooting Tips

Before You Call
For Service 27

Troubleshooting alarm code
. 28-30

Customer Service

Replacement Parts 31

Cavity Insert 32

Wiring Diagram 33

If You Need
Service 36



FOR YOUR RECORDS

Write the model and serial numbers here:

You can find them on a label on the appliance.

Staple sales slip or cancelled check here.

Proof of the original purchase date is needed to obtain service under the warranty.



READ THIS MANUAL

Inside you will find many helpful hints on how to use and maintain your water heater properly. Just a little preventive care on your part can save you a great deal of time and money over the life of your water heater.

You'll find many answers to common problems in the Before You Call For Service section. If you review our chart of Troubleshooting Tips first, you may not need to call for service at all.



READ THE SAFETY INFORMATION

Your safety and the safety of others are very important. There are many important safety messages in this manual and on your appliance. Always read and obey all safety messages.



This is the safety alert symbol. Recognize this symbol as an indication of Important Safety Information!

This symbol alerts you to potential hazards that can kill or hurt you and others.

All safety messages will follow the safety alert symbol and either the word "DANGER", "WARNING", "CAUTION" or "NOTICE".

These words mean:

▲ DANGER

An imminently hazardous situation that will result in death or serious injury.

▲ WARNING

A potentially hazardous situation that could result in death or serious injury and/or damage to property.

▲ CAUTION

A potentially hazardous situation that may result in minor or moderate injury.

NOTICE:

Attention is called to observe a specified procedure or maintain a specific condition.

IMPORTANT SAFETY INFORMATION. READ ALL INSTRUCTIONS BEFORE USING.

⚠ DANGER!

WATER TEMPERATURE SETTING

Safety and energy conservation are factors to be considered when selecting the water temperature setting of water heater. Water temperatures above 125°F can cause severe burns or death from scalding. Be sure to read and follow the warnings outlined on the label pictured below. This label is also located on the water heater near the thermistor access panel.

⚠
DANGER

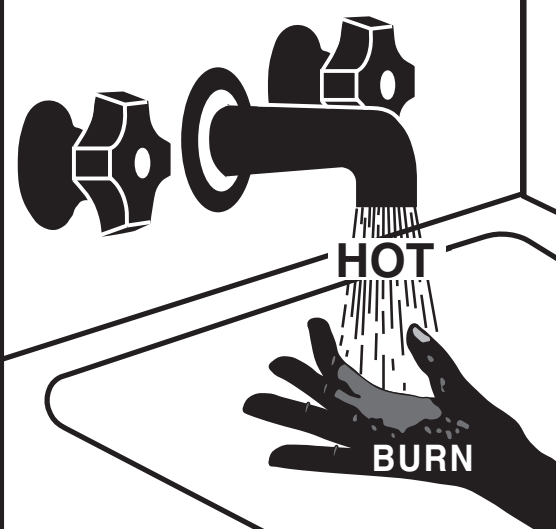

Water temperature over 125°F can cause severe burns instantly or death from scalds.

Children, disabled and elderly are at highest risk of being scalded.

See instruction manual before setting temperature at water heater.

Feel water before bathing or showering.

Temperature limiting valves are available, see manual.

Time/Temperature Relationship in Scalds

Temperature	Time To Produce a Serious Burn
120°F (49°C)	More than 5 minutes
125°F (52°C)	1½ to 2 minutes
130°F (54°C)	About 30 seconds
135°F (57°C)	About 10 seconds
140°F (60°C)	Less than 5 seconds
145°F (63°C)	Less than 3 seconds
150°F (65°C)	About 1½ seconds
155°F (68°C)	About 1 second

Table courtesy of Shriners Burn Institute

The chart shown above may be used as a guide in determining the proper water temperature for your home.

⚠ DANGER: Households with small children, disabled, or elderly persons may require a 120°F or lower thermostat setting to prevent contact with “HOT” water.

The temperature of the water in the heater is regulated by the water heater interface control. To comply with safety regulations the temperature was set at 120°F before the water heater was shipped from the factory.

The illustration below shows the water temperature setting.

Refer to the Operating Instructions in this manual for detailed instructions in how to adjust the water temperature.

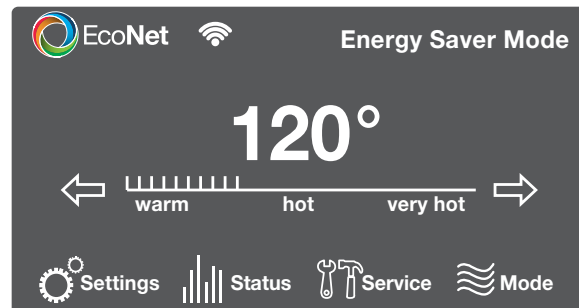

⚠ DANGER: Hotter water increases the potential for Hot Water SCALDS.

NOTICE: Mixing valves are recommended for reducing point of use water temperature by mixing hot and cold water in branch water lines. It is recommended that a mixing valve complying with the Standard for Temperature Actuated Mixing Valves for Hot Water Distribution Systems, ASSE 1017 be installed. See page 16 for more details and contact a licensed plumber or the local plumbing authority for further information.

IMPORTANT SAFETY INFORMATION. READ ALL INSTRUCTIONS BEFORE USING.

WARNING!

For your safety, the information in this manual must be followed to minimize the risk of fire or explosion, electric shock, or to prevent property damage, personal injury, or loss of life.

Be sure to read and understand the entire Use and Care Manual before attempting to install or operate this water heater. It may save you time and cost. Pay particular attention to the Safety Instructions. Failure to follow these warnings could result in serious bodily injury or death. Should you have problems understanding the instructions in this manual, or have any questions, STOP, and get help from a qualified service technician, or the local electric utility.



FOR INSTALLATIONS IN THE STATE OF CALIFORNIA

California Law requires that residential water heaters must be braced, anchored or strapped to resist falling or horizontal displacement due to earthquake motions. For residential water heaters up to 52-gallon capacity, a brochure with generic earthquake bracing instructions can be obtained from: Office of the State Architect, 1102 Q Street, Suite 5100, Sacramento, CA 95814 or you may call 916-445-8100 or ask a water heater dealer.

However, applicable local codes shall govern installation. For residential water heaters of a capacity greater than 52 gallons, consult the local building jurisdiction for acceptable bracing procedures.



SAFETY PRECAUTIONS

Have the installer show you the location of the circuit breaker and how to shut it off if necessary. Turn off the circuit breaker if the water heater has been subjected to overheating, fire, flood, physical damage or if the ECO (temperature limiting control) fails to shut off.



- Read this manual entirely before installing or operating the water heater.

- Use this appliance only for its intended purpose as described in this Use and Care Manual.



- Be sure your appliance is properly installed in accordance with local codes and the provided installation instructions.

- **DO NOT** attempt to repair or replace any part of your water heater unless it is specifically recommended in this manual. All other servicing should be referred to a qualified technician.

- **DO NOT** attempt to repair or replace the compressor, refrigerant, or any part associated with the sealed refrigerant system.

- **DO NOT** turn on the electrical supply or operate this water heater unless it is completely full of water.

WARNING!

Disconnect all power to unit before starting maintenance. Failure to do so can cause electrical shock resulting in severe personal injury or death.

WARNING!

FLAMMABLE CONTENTS UNDER PRESSURE. The compressor is not a serviceable part. The compressor wiring terminals may arc allowing pressurized refrigerant and oil to escape, ignite and cause serious bodily injury, severe burns or death.



READ AND FOLLOW THIS SAFETY INFORMATION
CAREFULLY.

SAVE THESE INSTRUCTIONS

Refrigerant

This Hybrid Water Heater is factory charged with an environmentally friendly, non-chlorinated refrigerant, R134A. This refrigerant has zero ozone depletion potential.

Installing the water heater

Inspect Shipment

Inspect the water heater for possible damage. Check the markings on the rating plate of the water heater to be certain the power supply corresponds to the water heater requirements. Rating plate is located on front of water heater.

The location chosen for the water heater must take into consideration the following:

Local Installation Regulations

This water heater must be installed in accordance with these instructions, local codes, utility codes, utility company requirements or, in the absence of local codes, the latest edition of the National Electrical Code. It is available from some local libraries or can be purchased from the National Fire Protection Association,

Batterymarch Park, Quincy, MA 02269 as booklet ANSI/NFPA 70.

Canadian installations should refer to CSA22.1, a copy can be purchased from the Canadian Standards Association, 5050 Spectrum Way, Mississauga, ONT L4W 5N6

Location

Locate the water heater in a clean dry area as near as practical to the area of greatest heated water demand. Long un-insulated hot water lines can waste energy and water.

Place the water heater in such a manner that the thermistor and element access panels can be removed to permit inspection and servicing such as removal of elements or checking controls.

The water heater and water lines should be protected from freezing temperatures. **DO NOT** install the water heater in outdoor, unprotected areas.

Make certain the floor underneath the water heater is strong enough to sufficiently support the weight of the water heater once it is filled with water.

For installation on floors other than concrete, the floor isolation kit is recommended to minimize vibrations.

▲CAUTION: The water heater should not be located in an area where leakage of the tank or connections will result in damage to the area adjacent to it or to lower floors of the structure. Where such areas cannot be avoided, it is recommended that a suitable drain pan, adequately drained, be installed under the water heater.

NOTICE: Installation in a confined space will lead to higher power consumption if adequate ventilation is not provided.

It is recommended that the hybrid water heater be installed where ambient temperatures **DO NOT** exceed 145°F (63°C).

Insufficient air exchange will result in increased energy consumption levels.

Clearances		
Rear	Sides	Top
0"	0"	6"

NOTICE: Auxiliary drain pan MUST conform to local codes.

Drain Pan Kits are available from the store where the water heater was purchased, or any water heater distributor.

Drain Pan should not obstruct cold inlet or drain valve.

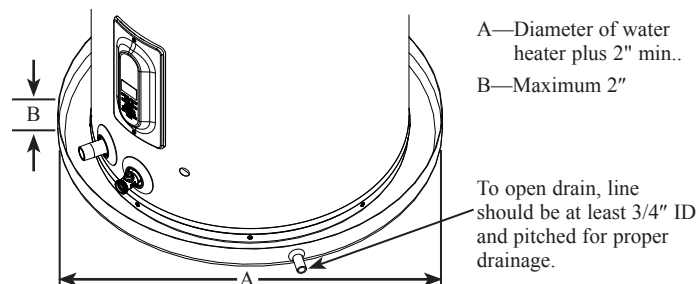

Installing the water heater

Locations that provide optimal efficiency

Heater: Not Ducted

Room size: Larger than 700 ft³ (e.g. 7' x 10' x 10').
Requirements: No additional ventilation needed.

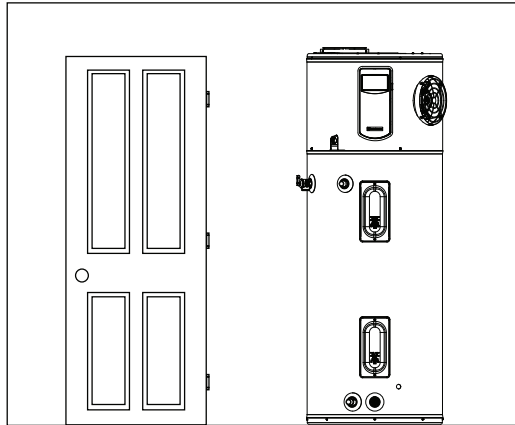

Heater: Not Ducted

Room size: Smaller than 700 ft³ (e.g. 7' x 10' x 10').
Requirements: Full louvered door OR two louvers top and bottom.

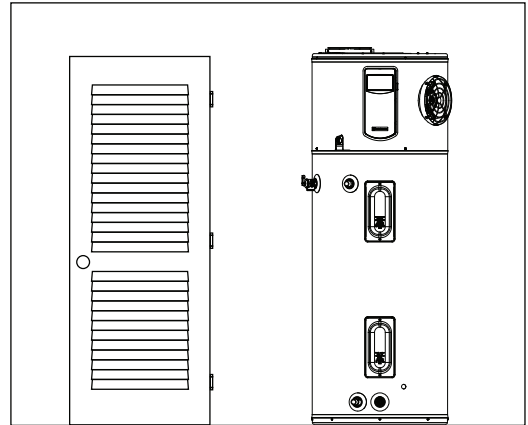

Heater: Not ducted

Room: Small Closet

- Requirements:
- * Air gap under door equal to 18 in² (0.75" clearance).
 - * Louver must be located the same height on door as the air exhaust on heater.
 - * Heater air exhaust must be positioned towards louver within one foot of door.

NOTICE: If air temperature in installed location drops more than 15°F (8°C) during heating, air circulation is insufficient for efficient operation. Utilize ducting to direct cold exhaust air to another location.

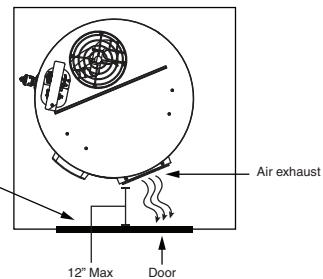
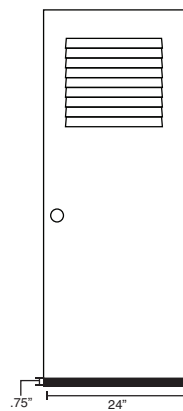

Heater: Ducted with inlet OR outlet duct

Room size: Any size room
Requirements: Air gap under door equal to 18 in² (0.75" clearance)

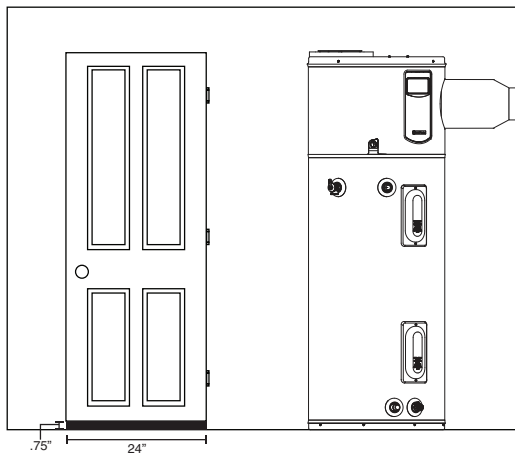

Heater: Ducted with inlet AND outlet duct

Room size: Any size room
Requirements: No additional ventilation needed.

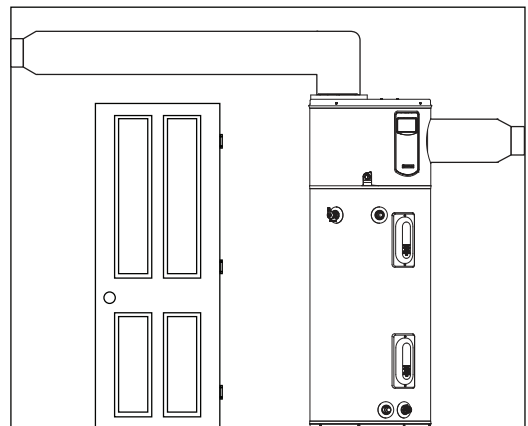

Thermal Expansion

Determine if a check valve exists in the inlet water line. Check with your local water utility. It may have been installed in the cold water line as a separate back flow preventer, or it may be part of a pressure reducing valve, water meter or water softener. A check valve located in the cold water inlet line can cause what is referred to as a “**closed water system**”. A cold water inlet line with no check valve or back flow prevention device is referred to as an “**open**” water system.

As water is heated, it expands in volume and creates an increase in the pressure within the water system. This action is referred to as “**thermal expansion**”. In an “**open**” water system, expanding water which exceeds the capacity of the water heater flows back into the city main where the pressure is easily dissipated.

A “**closed water system**”, however, prevents the expanding water from flowing back into the main supply line, and the result of “**thermal expansion**” can create a rapid and dangerous pressure increase in the

water heater and system piping. This rapid pressure increase can quickly reach the safety setting of the relief valve, causing it to operate during each heating cycle.

Thermal expansion, and the resulting rapid and repeated expansion and contraction of components in the water heater and piping system can cause premature failure of the relief valve, and possibly the heater itself. Replacing the relief valve **WILL NOT** correct the problem!

The suggested method of controlling thermal expansion is to install an expansion tank in the cold water line between the water heater and the check valve (refer to the illustration on the next page). The expansion tank is designed with an air cushion built in that compresses as the system pressure increases, thereby relieving the over pressure condition and eliminating the repeated operation of the relief valve. Other methods of controlling thermal expansion are also available. Contact your installing contractor, water supplier or plumbing inspector for additional information regarding this subject.

NOTICE: The inlet and outlet water nipple remain with the black markings pointed up.

Water Supply Connections

Refer to the illustration on the next page for suggested typical installation. The installation of flexible connectors is recommended on the hot and cold water connections. Flexible connections provide vibration isolation and allow the water heater to be easily disconnected for servicing if necessary. The **HOT** and **COLD** water connections are clearly marked and are 3/4in. NPT on all models. Install a shut-off valve in the cold water line near the water heater.

See page 8 on "To Fill The Water Heater".

NOTICE: DO NOT apply heat to the HOT or COLD water connections. If sweat connections are used, sweat tubing to adapter before fitting adapter to the water connections on heater. Any heat applied to the water supply fittings will permanently damage the dip tube and/or heat traps.

Condensate Drains

Consult local codes or ordinances for specific requirements. Refer to page 7.

IMPORTANT: When making drain fitting connections to the drain tubing, use a thin layer of piping tape or silicone and install hand tight.

IMPORTANT: When making drain fitting connections to the drain tubing, **DO NOT** overtighten. Overtightening fittings can split pipe connections on the drain pan.

- This unit is equipped with a 3/4" NPT female primary condensate connection. Use MIP fittings for connections.
- **DO NOT** reduce drain line size less than connection size provided on condensate drain.

- All drain lines must be pitched downward away from the unit a minimum of 1/8" per foot of line to ensure proper drainage.
- Drain lines must include a P-trap if connected to a sewer pipe.
- If no drain is available, then a common condensate pump with a capacity no less than 2 gallon per day must be installed.
- **DO NOT** allow condensate to drain into the water heater drain pan.
- The drain line should be insulated where necessary to prevent sweating and damage due to condensate forming on the outside surface of the line.

NOTICE: Condensate from this unit is not Acidic and is not required to be neutralized.

Installing the water heater

Typical Installation

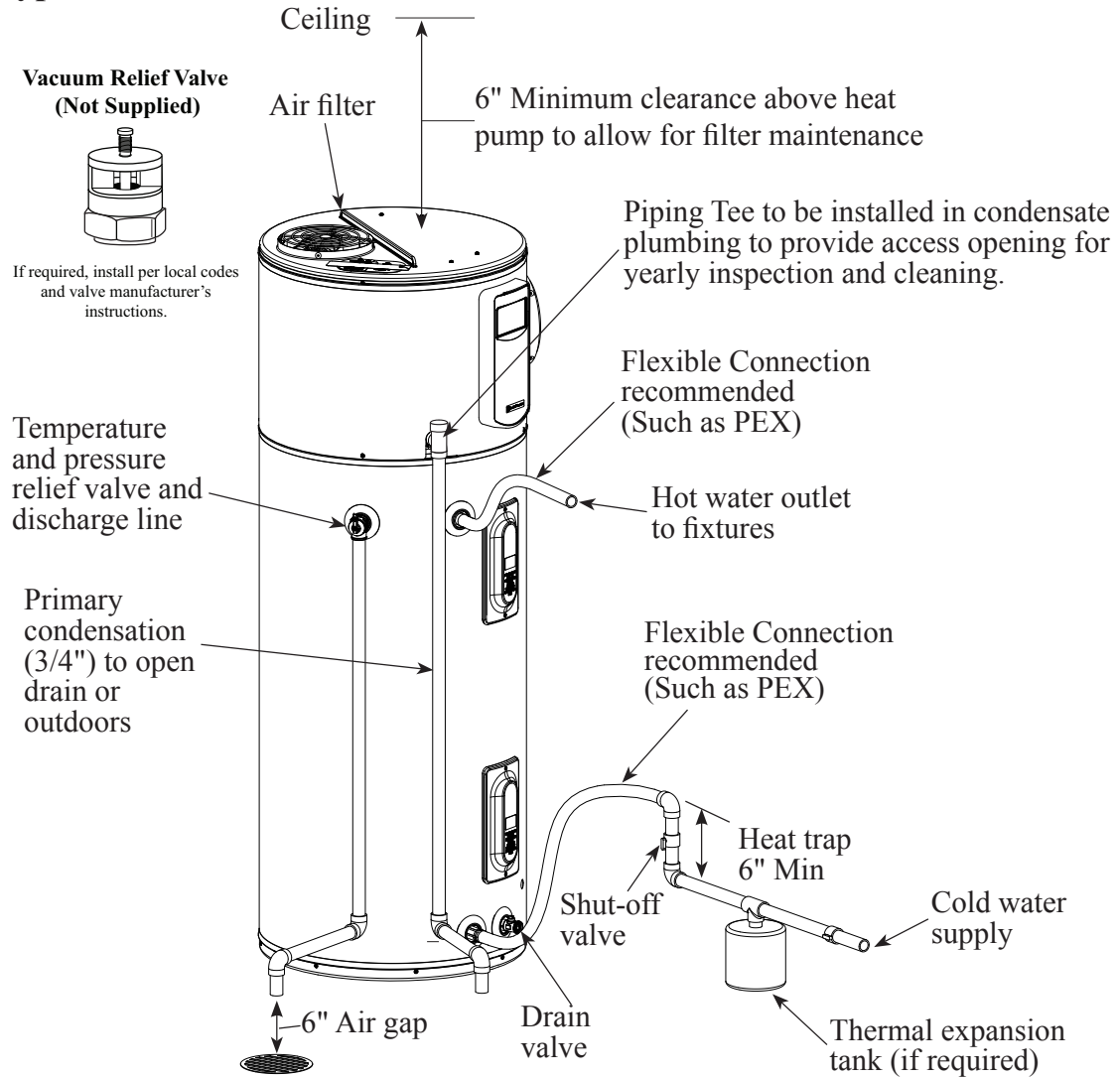

A new combination temperature and pressure relief valve, complying with the Standard for Relief Valves for Hot Water Supply Systems, ANSI Z21.22/CSA 4.4, is factory installed and must remain in the opening provided and marked for the purpose on the water heater. No valve of any type should be installed between the relief valve and the tank.

▲WARNING: The pressure rating of the relief valve must not exceed 150 PSI, the maximum working pressure of the water heater as marked on the rating plate.

Relief Valve

The btu/h rating of the relief valve must not be less than the input rating of the water heater as indicated on the rating label located on the front of the heater (1 watt=3.412 btu/h).

Connect the outlet of the relief valve to a suitable open drain so that the discharge water cannot contact live electrical parts or persons and to eliminate potential water damage.

Piping used should be of a type approved for hot water distribution. The discharge line must be no smaller than the outlet of the valve and must pitch downward from the valve to allow complete drainage (by gravity) of the relief valve and discharge line. The end of the discharge line should not be threaded or concealed and should be protected from freezing. No valve of any type, restriction or reducer coupling should be installed in the discharge line.

▲WARNING: DO NOT connect other plumbing to the T&P plumbing; it must go directly to a suitable open drain. DO NOT connect the T&P plumbing to the condensate plumbing.

⚠WARNING: DO NOT turn on the electrical supply or operate this water heater unless it is completely full of water. The tank must be full of water before water heater is turned on. The water heater warranty does not cover damage or failure resulting from operation with an empty or partially empty tank.

To Fill the Water Heater

Make certain the drain valve on the water heater is completely closed.

Open the shut-off valve in the cold water supply line.

Open each hot water faucet slowly to allow the air to vent from the water heater and piping.

A steady flow of water from the hot water faucet(s) indicates a full water heater.

EcoNet™ Communication

EcoNet™ communication is provided for integration with home automation, energy management, and demand response systems. Connectivity is provided through the EcoNet port or via wireless (Wi-Fi).

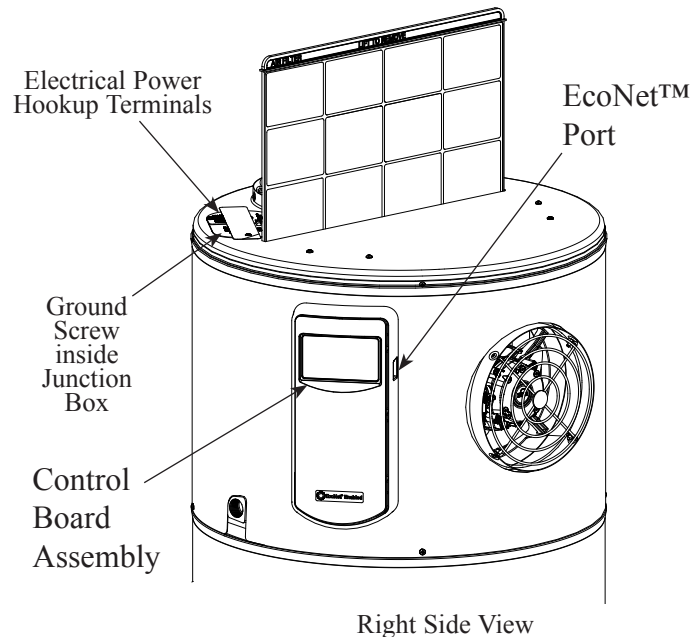

Electrical Connections

⚠WARNING: Turn off electric power at the fuse box or service panel before making any electrical connections.

Also, the ground connection must be completed before making line voltage connections. Failure to do so can result in electrical shock, severe personal injury or death.

Disconnect all power to unit before starting maintenance. Failure to do so can cause electrical shock resulting in severe personal injury or death

The unit must be grounded. Failure

to do so can cause electrical shock resulting in severe personal injury or death.

If the water heater has been subjected to fire, flood or physical damage, **DO NOT** operate the water heater again until it has been checked by a qualified service technician.

NOTICE: DO NOT use this appliance if any part has been under water. Immediately call a qualified installer or service agency to replace a flooded water heater. DO NOT attempt to repair the unit! It must be replaced.

Installing the water heater

Electrical Connections continued...

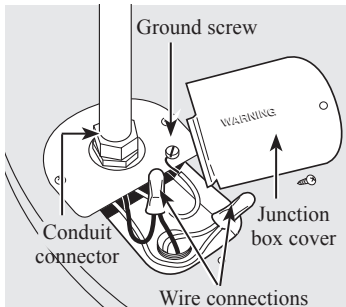

Water heater junction box.

⚠ DO NOT turn on the electrical supply or operate this water heater unless it is completely full of water.

A separate branch circuit with copper conductors, overcurrent protective device and suitable disconnecting means must be provided by a qualified electrician.

All wiring must conform to local codes or latest edition of National Electrical Code ANSI/NFPA 70.

The water heater is completely wired to the junction box inside jacket at the top front of the water heater. An opening for 1/2 in. or 3/4 in. electrical fitting is provided for field wiring connections.

The voltage requirements and wattage load for the water heater are specified on the rating plate on the front of the water heater.

The branch circuit wiring should include either:

- 1** Metallic conduit or metallic sheathed cable approved for use as a grounding conductor and installed with fittings approved for the purpose.
- 2** Non-metallic sheathed cable, metallic conduit or metallic sheathed cable not approved for use as a ground conductor shall include a separate conductor for grounding. It should be attached to the ground terminals of the water heater and the electrical distribution box.

⚠ CAUTION: The presence of water in the piping and water heater does not provide sufficient conduction for a ground. Non-metallic piping, dielectric unions, flexible connectors etc. can cause the water heater to be electrically isolated.

⚠ WARNING: If local codes require external application of insulation blanket kits the manufacturer's instructions included with the kit must be carefully followed.

Insulation Blankets

Insulation blankets, available to the general public, for external use on electric water heaters are not necessary. The purpose of an insulation blanket is to reduce the standby heat loss encountered with storage tank heaters. This water heater meets or exceeds the National Appliance Energy Conservation Act standards with respect to insulation and standby loss requirements making an insulation blanket unnecessary.

The manufacturer's warranty does not cover any damage or defect caused by installation, attachment or use of any type of energy saving or other unapproved devices (other than those authorized by the manufacturer) into, onto or in conjunction with the water heater. The use of unauthorized energy saving devices may shorten the life of the water heater and may endanger life and property.

The manufacturer disclaims any responsibility for such loss or injury resulting from the use of such unauthorized devices.

⚠ CAUTION: If local codes require the application of an external insulation blanket to this water heater, pay careful attention to the following so as not to restrict the proper function and operation of the water heater:

- **DO NOT** cover the operating or warning labels attached to the water heater or attempt to relocate them on the exterior of insulation blanket.
- **DO NOT** cover air openings on both sides of the water heater .
- **DO NOT** cover the Controller Assembly, temperature and pressure relief valve or drain valve.
- Inspect the insulation blanket frequently.

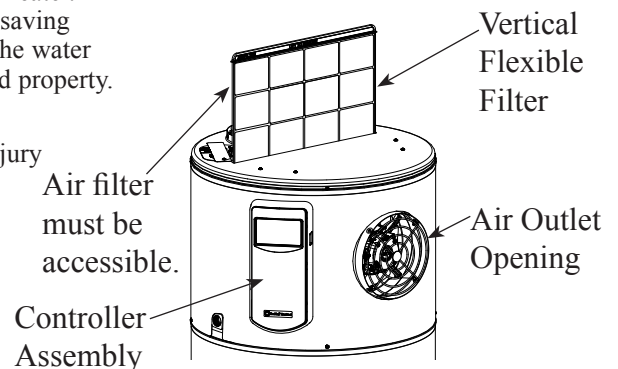

Hot and Cold Pipe Insulation Installation

Install the insulation on the cold water supply inlet and the hot water outlet as shown in the illustration.

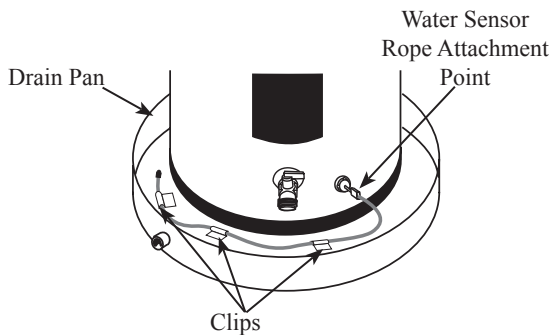
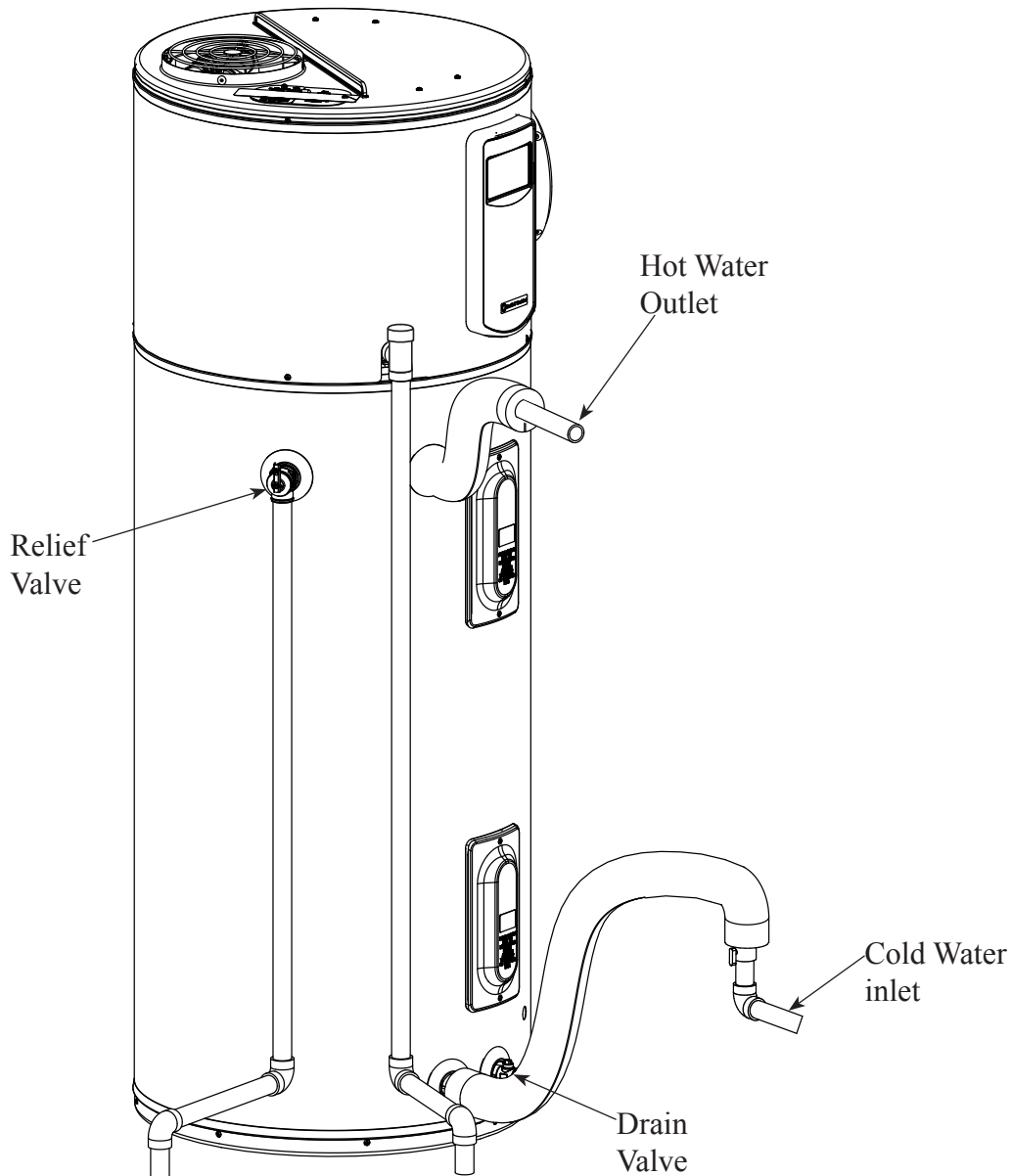

Water Sensor

In order to detect the presence of unwanted water, this water heater is supplied with a built-in water sensing circuit. The water sensor rope is shipped in the warranty bag for field installation.

Remove water sensor rope from the bag and attach to the connector located near the lower access panel. Place the rope in the

recommended drain pan and secure to the pan bottom with provided self adhesive clips.

When water is detected, the electronic control will turn off the heating elements, flash the display backlight and turn on an audible alarm.

Installing the water heater

Ducting Requirements

Always check with local building and HVAC codes before designing the duct system

The water heater may be ducted to the outdoors or another space as described in these instructions. Ducting configurations that does not comply with these guidelines are not supported.

DO NOT connect this water heater to existing duct work; it must be ducted separately from other appliances.

Ducting approved for HVAC applications is required.

Ducting must be adequately supported along both vertical and horizontal lengths.

UL Certified terminations must be used for ducting to the outside. These terminations have been evaluated to ensure there is sufficient protection from rain water entry and resistance to air flow is minimized.

Indoor registers approved for HVAC applications is required.

Rigid ducting must be isolated from floor joists or other structural members to minimize the transmission of noise and vibration. A short section (12 inch minimum) of flexible duct must be used between the water heater and rigid ducting as an isolation method.

Every foot of flexible ducting counts as three feet of rigid ducting.

Ducting must be insulated per HVAC codes (to prevent condensation).

Ensure cold air exhaust is sufficiently away from structures to prevent condensation on surfaces.

Maximum heater performance is obtained by lowering the resistance to air flow (regular filter maintenance is beneficial) and providing the unit with warm moist air.

Considerations when planning the duct system:

- Run the ducting the most direct route possible.
- Limit the number of elbows/bends.
- Use the largest duct size possible.
- Use the largest termination possible.
- Consider placement and direction of terminations (reduce recirculation of exhaust into the intake).

Calculated length of duct is the length on the inlet plus the length on the outlet. Any combination of duct lengths on the inlet and outlet is supported up to the maximum duct length (Table 1).

Duct System Configuration

The inlet and outlet ducting connections on the water heater accepts 8 inch diameter ducting. No additional adaptors are needed.

7 inch, 6 inch, 5 inch diameter ducting is supported. Table 1 lists the total feet of ducting allowed. For duct diameters smaller than 8 inch

diameter, Table 1 takes into account the duct reducer(s) and up to 10 feet of 8 inch rigid ducting (two elbows) before the duct reducer(s) at the unit. Duct Reducers must be installed within 10 feet (two elbows) of the unit or within 2 feet of the end of the duct.

Table 1.- Maximum Duct Length.

Duct Type / Diameter	8"	7"	6"	5"
Rigid	340'	160'	65'	17'
Flexible	125'	65'	25'	--

Equivalent feet for Duct Accessories

Elbows/Bends

Rigid duct elbows and flex bends greater than 45° is considered an elbow.

Flexible ducting bends' inner radius cannot be less than its diameter. If bends with tighter radiuses are needed, a rigid elbow must be used.

Maximum number of elbows/bends allowed are shown in [brackets] in Table 2.

Terminations/Registers

Table 2 equivalent feet for terminations includes the rodent screen.

For terminations and registers with smaller diameters than the duct

diameter, Table 2 accounts for the duct reducer and termination/register. Smaller diameter terminations and registers with more than a 2 ft. connection is not supported.

Damper

If ducting to the outside using an exhaust duct only (no intake duct), an approved Rheem damper should be installed no further than 10 ft. of rigid ducting total (two elbows equivalent) from the unit. This prevents outside air from coming into the living space. If ducting air from the outside to the inlet of the heater, no provision is made to prevent outside air from flowing into the living space.

Table 2.- Equivalent feet for Duct Accessories.

Description	8"	7"	6"	5"
Elbows/Flexible Bends (Each) [Maximum Allowed]	5' [8]	5' [6]	5' [4]	5' [2]
8 inch UL Certified Termination for ducting outside (Each)	5'	5'	5'	5'
Reduced diameter UL Certified Termination for ducting outside (Each)	N/A	10'	15'	20'
8 inch Register for ducting inside (Each)	5'	5'	5'	5'
Reduced diameter Register for ducting inside (Each)	N/A	10'	15'	20'
Rodent Screen (must be greater than 83% open area) (Each)	1'	1'	1'	1'
Rheem approved 8" diameter Duct Damper	25'	20'	10'	5'

Table 2 lists equivalent feet for duct accessories and reduced diameter terminations.

Accessory Kits

Part Number	Description	User For
SP20882	Earthquake Isolation Kit for Hybrid Water Heater.	Installations in Seismic Regions.
SP20883	Vibration Isolation Kit for Hybrid Water Heater.	Installation on Non-Concrete floors.
SP20884	8" Dia. UL Certified Termination kit.	Termination to the outside or to attic with 8" diameter.
SP20885	7" Dia. UL Certified Termination kit.	Termination to the outside or to attic with 7" diameter.
SP20886	6" Dia. UL Certified Termination kit.	Termination to the outside or to attic with 6" diameter.
SP20887	5" Dia. UL Certified Termination kit.	Termination to the outside or to attic with 5" diameter.
SP20888	8" Rheem Approved Damper Kit.	Exhaust only to the outside Ducting Configuration (No inlet Duct).
SP20889	25' Flexible 8" dia. duct kit.	For up to 25' of Ducting.
SP20890	Rigid Elbow duct kit.	Installation in tight places where space needs to be minimized.

Installation Checklist

NOTICE: These seven questions should be answered to ensure correct duct configuration. See Ducting Example.

Ducting Example:

- 1 Exhaust/Inlet or both? Both, Inlet and Outlet
- 2 Ducting to outside of building or another room? Outside building.
- 3 Length of duct from water heater to termination? 20 ft.
- 4 Flexible or Rigid ducting? Flexible.
- 5 Diameter of ducting used? 8 in. Diameter
- 6 Diameter of wall penetrations? 5 in. Diameter
- 7 Number of elbows/bends? 3 Total – One on inlet and Two on Outlet
 - I. Does calculated ducting length exceed maximum allowable table?
 - a. 20 ft. (Outlet duct length)
 - b. 10 ft. (1 rigid elbow and 1 bend on outlet)
 - c. 20 ft. (reduced diameter termination outlet)
 - d. 20 ft. (Inlet duct length)
 - e. 5 ft. (1 Bend on inlet)
 - f. 20 ft. (reduced diameter termination inlet)
 - g. **Total = 20+10+20+20+5+20 = 95 ft.**

Using flexible 8 in. diameter duct, the maximum duct length allowed is 125 ft.; therefore, because 95 ft. is less than 125 ft., this is an acceptable ducting configuration.

Accessory Kits SP20887 (2 Kits), SP20889 (2 Kits) and SP20890 (1 Kit) should be purchased for this installation.

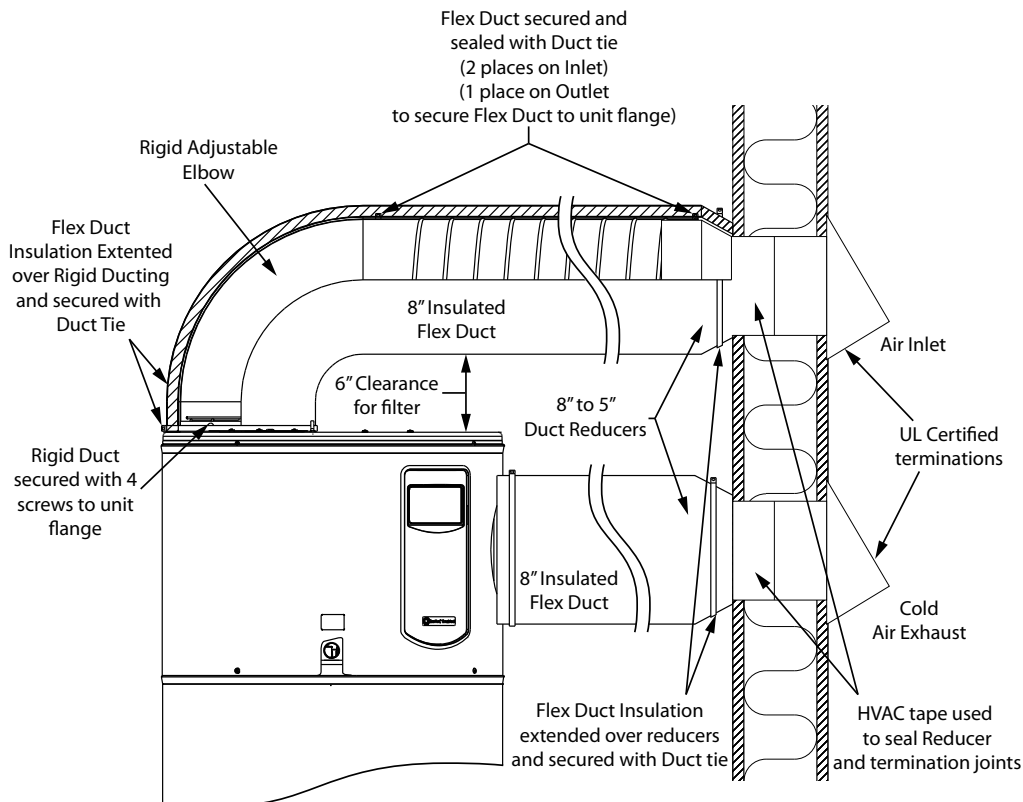

Horizontal Duct Installation

Once the duct terminal location has been determined, make a hole through the exterior wall to accommodate the UL Certified Termination. Termination must exit exterior wall horizontally only.

Complete rest of the duct pipe installation to the water heater's duct connector fitting.

If necessary, support horizontal run as previously mentioned.

A. Water Heater Location

- Close to area of heated water demand.
- Indoors and protected from moisture, wet conditions, freezing temperatures (below 32°F) and High temperatures (above 140°F).
- Area free of flammable vapours.
- Provisions for Air Circulation (Louvered doors on ducting).
- Provisions made to protect area from water damage.
- Sufficient room to service heater.
- Six inches (6") of clearance from ceiling to top of Hybrid Water Heater to allow for filter maintenance.
- Access to condensate disposal.
- Vibration Isolation Kit (Non-Concrete floors).
- Hybrid seismic Kit (if required)

B. Water Supply

- Water heater completely filled with water.
- Air purged from water heater and piping.
- Water connections tight and free of leaks.
- Flexible water connections.

C. Relief Valve

- Temperature and Pressure Relief Valve properly installed and discharge line run to open drain.
- Discharge line protected from freezing.

D. Wiring

- Power Supply voltage agrees with water heater rating plate.
- Branch circuit wire and fusing or circuit breaker of proper size. (Recommended 15 amp & 30 amp breaker for select models).
- Electrical connections tight and unit properly grounded.
- 10 gauge wire.

E. Condensate Lines

- Condensate lines from heat pump installed correctly.
- Condensate lines from heat pump run to a suitable drain location.

F. Ducting

- HVAC approved ducting.
- Calculated length of duct no greater than maximum allowed.
- UL Certified terminations (For ducting to the outside).
- Insulated duct.
- Ducting adequately supported.
- Ducting adequately isolated from structure.

Operating the water heater

▲ CAUTION: Hydrogen gas can be produced in a hot water system served by this water heater that has not been used for a long period of time (generally two weeks or more). **HYDROGEN GAS IS EXTREMELY FLAMMABLE!!** To dissipate such gas and to reduce risk of injury, it is recommended that the hot water faucet be opened for several minutes at the kitchen sink before using any electrical appliance connected to the hot water system. If hydrogen is present, there will be an unusual sound such as air escaping through the pipe as the water begins to flow. **DO NOT** smoke or use an open flame near the faucet at the time it is open.

Safety Precautions

- A** Disconnect all power to water heater if it has been subjected to over heating, fire, flood, physical damage.
- B** **DO NOT** turn on water heater unless it is filled with water.
- C** **DO NOT** turn on water heater if cold water supply shut-off valve is closed.
- D** If there is any difficulty in understanding or following the Operating Instructions or the Care and Cleaning section, it is recommended that a qualified person or serviceman perform the work.

▲ WARNING: If the water heater has been subjected to fire, flood or physical damage, disconnect all power to water heater, and **DO NOT** operate the water heater again until it has been checked by a qualified service technician.

NOTICE: **DO NOT** use this appliance if any part has been under water. Immediately call a qualified installer or service agency to replace a flooded water heater. **DO NOT** attempt to repair the unit! It must be replaced.

Safety Controls

The water heater is equipped with a temperature limiting control (ECO) that is located above the upper heating element in contact with the tank surface. If for any reason the water temperature becomes excessively high, the temperature limiting control (ECO) breaks the power circuit to the heating element. Once the control opens, it must be reset manually.

▲ CAUTION: The cause of the high temperature condition must be investigated by qualified service technician and corrective action must be taken before placing the water heater in service again.

To reset the temperature limiting control: (Refer to Illustration in Cavity Insert section):

- 1** Disconnect all power to unit before starting maintenance.
- 2** Remove the upper cavity cover and insulation.
- 3** Press the red RESET button.
- 4** Replace the insulation, jacket access panel and plastic housing before turning on the power to the water heater.

▲ DANGER: There is a hot water scald potential if the thermostat is set too high. Households with small children, disabled, or elderly persons may require a 120°F or lower thermostat setting to prevent contact with **HOT** water.

Water Temperature Setting

The temperature of the water in the water heater can be regulated by selecting the desired temperature on control display.

Safety and energy conservation are factors to be considered when selecting the water temperature setting of the water heater. The lower the temperature setting, the greater the savings in energy and operating costs.

To comply with safety regulations the temperature is factory set at 120°F or less where local codes require. This is the recommended starting point.

Water temperatures above 125°F can cause severe burns or death from scalding. Be sure to read and follow the warnings outlined in this manual and on the label on the water heater.

This label is located on the front of the water heater.

Mixing valves are recommended for reducing point of use water temperature by mixing hot and cold water in branch water lines. It is recommended that a mixing valve complying with the Standard for Temperature Actuated Mixing Valves for Hot Water Distribution Systems, ASSE 1017 be installed. See page 4 for more details and contact a licensed plumber or the local plumbing authority for further information.

The chart on the page 3 may be used as a guide in determining the proper water temperature for your home.

Basic Water Heater Operation

Navigating the Home Screen

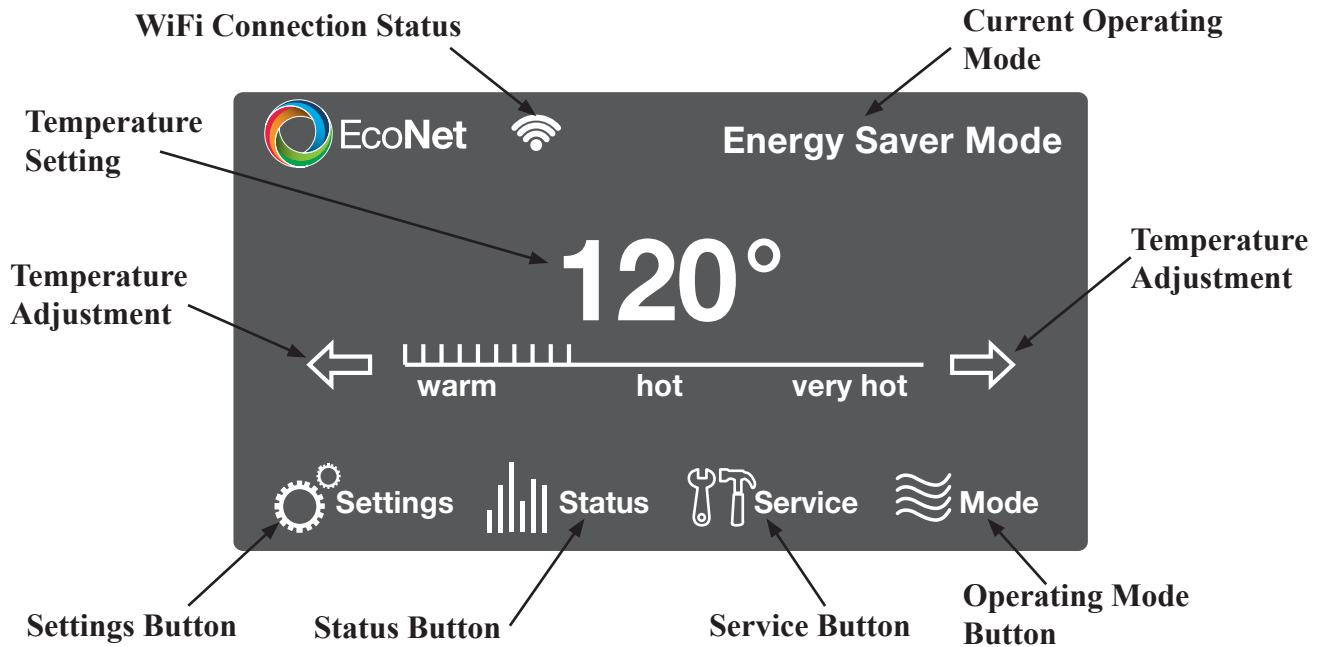

Operational Control and Modes

Once power is applied to the water heater, the Operational Control Buttons can be used to activate the heating of water.

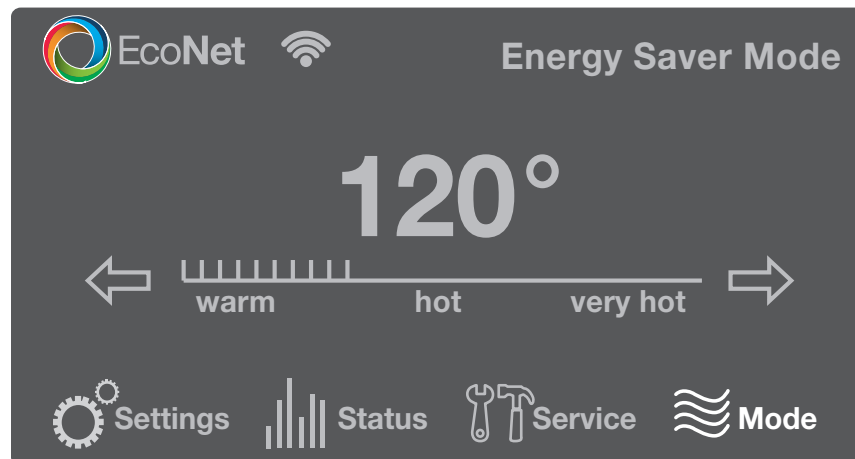

To turn the water heating "On", press the "Mode" button once.

Water heater ships in the default "Energy Saver" mode with a temperature setting of 120° F.

Recommended temperature setting 120° F.

To turn the water heating "OFF", press the "Mode" button repeatedly until the screen displays "Water Heater Off" Mode".

Basic Water Heater Operation

Operating Mode

Press the "Mode" button repeatedly to select one of the six modes of operation (the "Off" Mode has been discussed previously). The active mode is displayed on top of the screen.

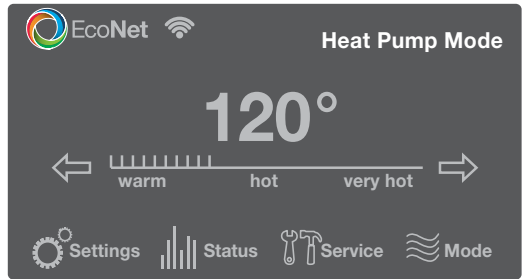

Heat Pump

This mode will heat with Heat Pump operation and will not use electric heat during typical heating and demand cycles. This mode has a low recovery, but minimizes power consumption.

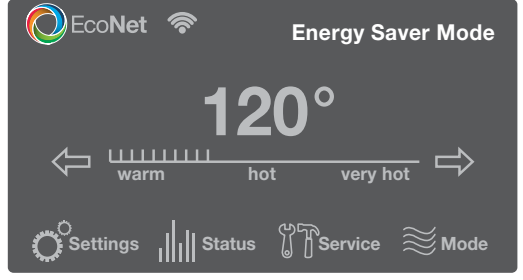

Energy Saver - Factory set mode for shipping.

This mode optimizes Heat Pump and electric heat that results in low power consumption and High recovery.

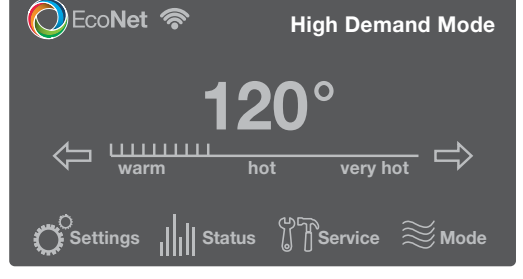

High Demand

This mode provides the highest recovery while still providing good energy savings. Water heater operates Heat Pump and electric heat simultaneously.

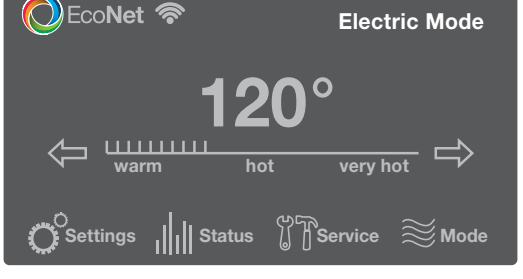

Electric

This Mode will heat with the electric resistance elements. This mode should only be used during filter and condensate drain maintenance periods. This mode will result in maximum power consumption. (See "Elec. Heat Override Time" in Settings).

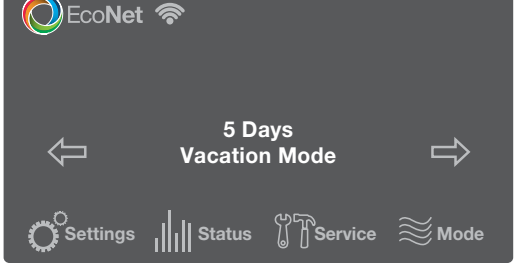

Vacation

This mode will allow duration setting between 1 and 28 days or set indefinitely with the "Hold" setting. Tank temperature will be maintained at about 65° F.

NOTICE: Energy Saver mode is not recommended for water systems utilizing recirculation.

Temperature Adjustment

⚠ DANGER: Hotter water increases the potential for **HOT** water SCALDS

Tank temperature will be maintained according to the setting on the Home Screen. If the water temperature setting needs adjustment, use the arrows on the control display to select desired temperature.

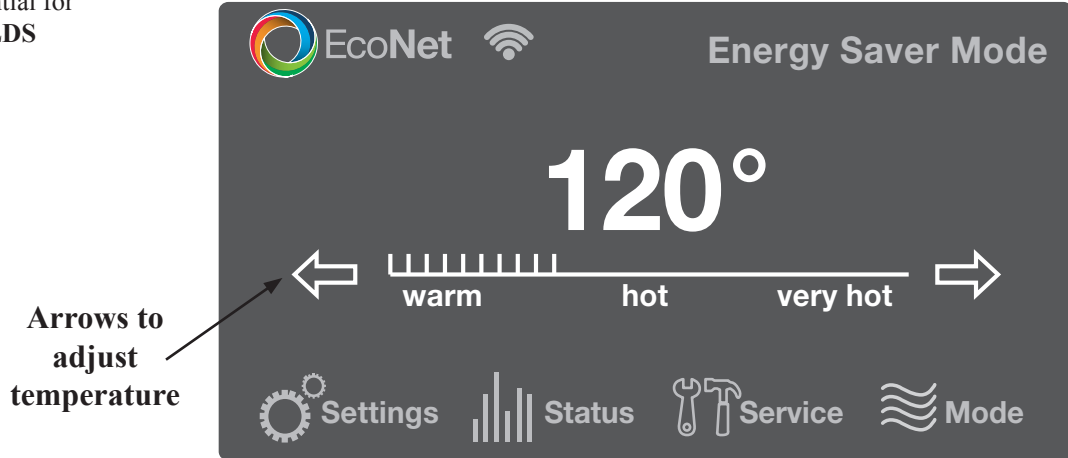

Settings

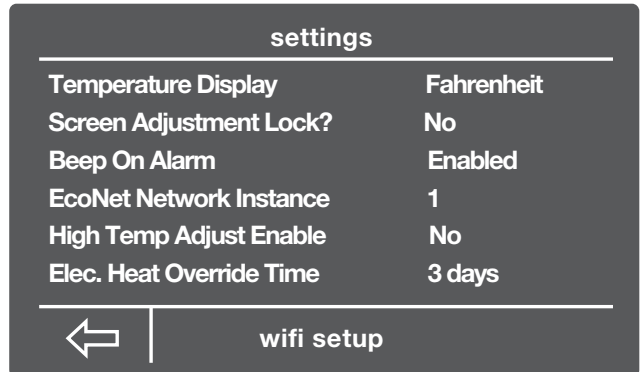

The Settings Screen allows the following changes:

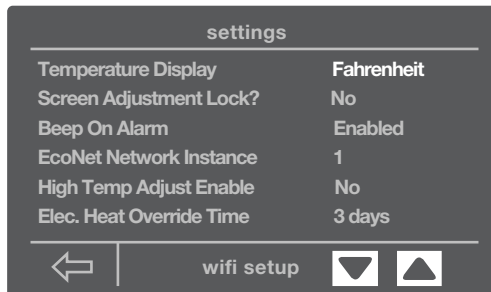

Temperature Display Units: The temperature display on the Home Screen can be set to Fahrenheit or Celsius.

To change temperature unit, press Fahrenheit to highlight, then press up/down buttons to change to Fahrenheit/Celsius.

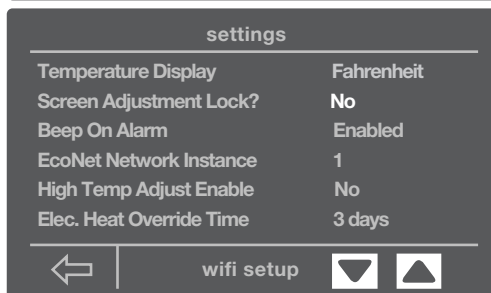

Home Screen Lock: The Home Screen can be locked to eliminate accidental changing of the Mode or Temperature.

To lock or unlock the screen, press No to highlight, then press up/down buttons to change Yes/No.

Basic Water Heater Operation

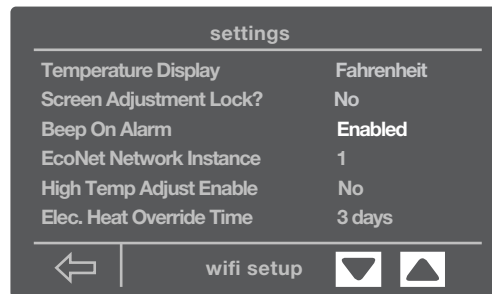

Beep on Alarm: The audible Alarm tone can be disabled during service periods. To Enabled/Disabled the audible alarm, press "Enabled" to highlight, then press up/down buttons to change to Enabled/Disabled.

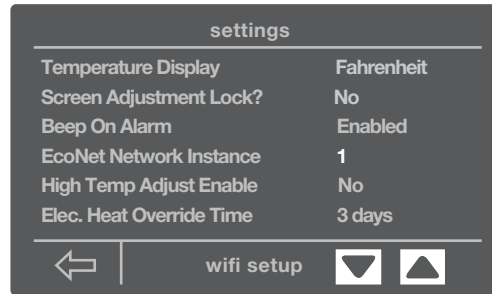

EcoNet Network Instance: This number can be set between 1 and 32. Instance is the way an EcoNet network identifies each appliance of the same model on the network. To change the instance number, press "1" to highlight, then change the number pressing the up/down buttons.

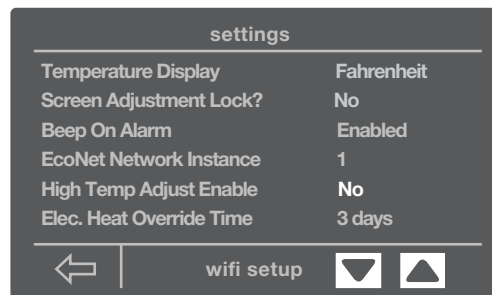

High Temperature Enable: This setting can be set to "Yes" if a tank temperature higher than 140°F is desired. This setting will automatically turn "No" after 10 minutes of inactivity on the user interface. To enable or disable temperature adjust, press "No" to highlight, then press up/down buttons to change to Yes/No.

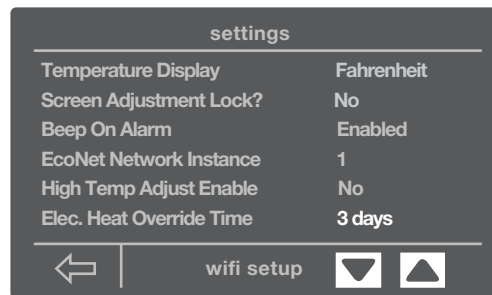

Elec. Heat Override Time: This setting can be set from 1 to 7 days and will return the unit to the previous (more efficient) mode after the set number of day is complete. To set the days, press "3 days" to highlight, then press up/down buttons to adjust the days.

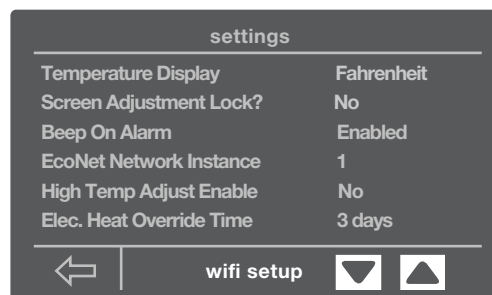

WiFi Setup: This button used when setting up a new wireless connection. Please refer to the Wi-Fi section for more information.

Service

The Service screen provides information on the product description, testing software version, and alarms. Alarm details can be found in the “Troubleshooting Alarm Codes” section of the manual.

In case there is an active alarm, the “alarms” button will blink in the lower right corner. Pressing the “Alarms” button will show a new screen containing the active alarms and alarm history.

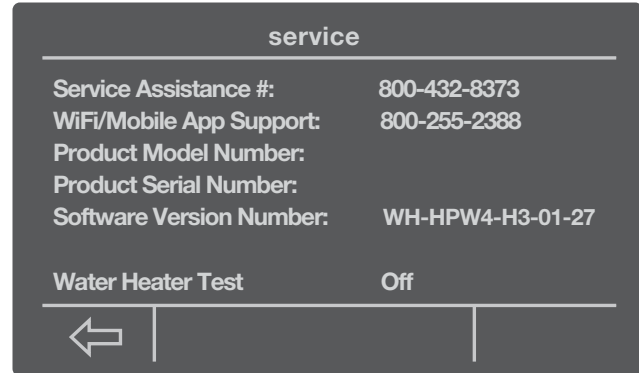

Status

The Status screen provides information on the current operating status, diagnostics, and sensors.

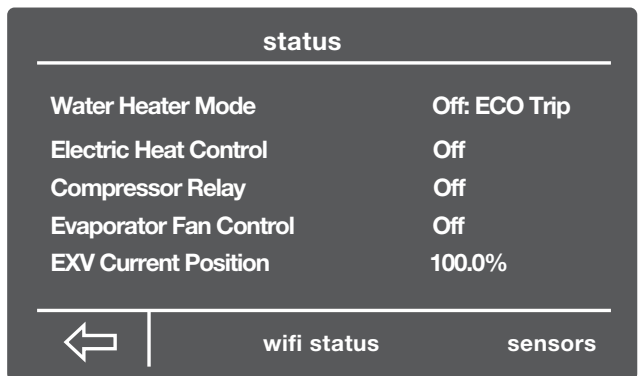

Pressing the "wifi status" button will show a screen with the Wi-Fi connection status. Please refer to the Wi-Fi section for more information.

Pressing the "sensors" button will show a screen containing the temperature readings of the tank and Heat Pump System.

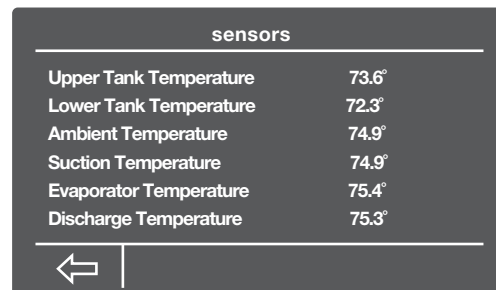

Basic Water Heater Operation

Wi-Fi



Your heater has integrated Wi-Fi capability. By connecting your heater to the internet, you can access the full benefits of the water heater, including remote control, leak detection alerts, and diagnostic alerts on your mobile device.

To complete Wi-Fi Setup on initial power up



1. Upon initial power up of the water heater, the user will be prompted to configure the wireless connection.
 - a. Tap "Get Started" to start this process immediately, or
 - b. "Setup Later" to setup at a later time. If setting up at a later time, skip to "To Complete Wi-Fi Setup after initial power up".
2. Download the Rheem EcoNet app via the App Store or Google Play to your mobile device.
3. Create an account and sign in.
4. The following screen should appear. Follow the instructions on the screen to connect your water heater to the internet.

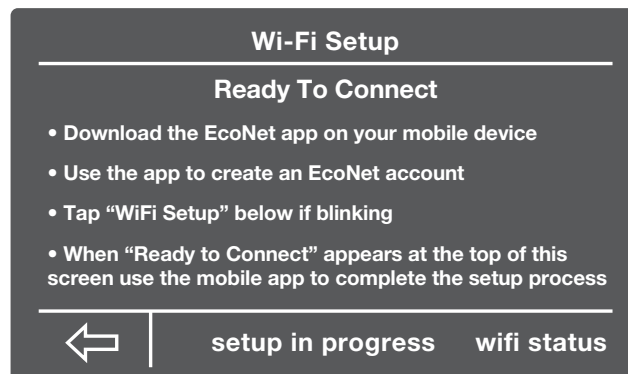

To complete Wi-Fi Setup after initial power up

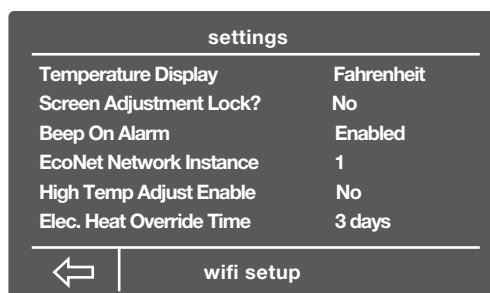

1. From the Home Screen, tap Settings, then wifi setup. Alternately, you may tap the wifi icon on the home screen, then tap the wifi setup button.

2. Tap "Get Started" to start the process.

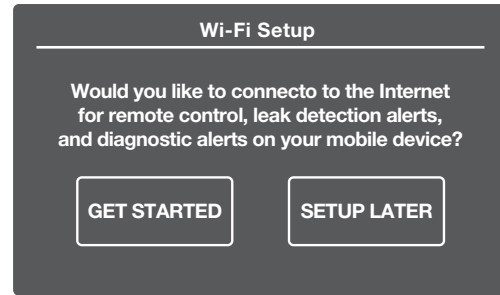

3. Download the Rheem EcoNet app via the App Store or Google Play to your mobile device.

4. Create an account and sign in.

5. The following screen should appear. Follow the instructions on the screen to connect your water heater to the internet.

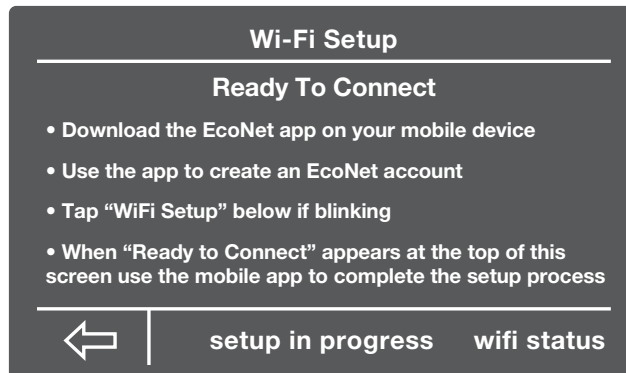

Wi-Fi Status

From the Home Screen, the wifi symbol reflects your current wifi signal strength. A slash through the icon can indicate that the wifi has not been setup, or has otherwise lost connection to the internet.

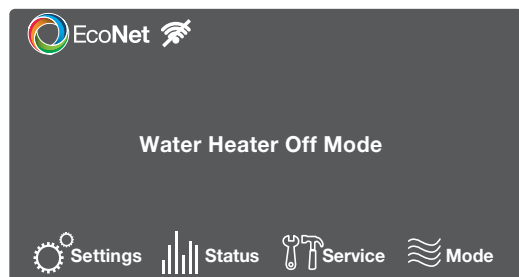
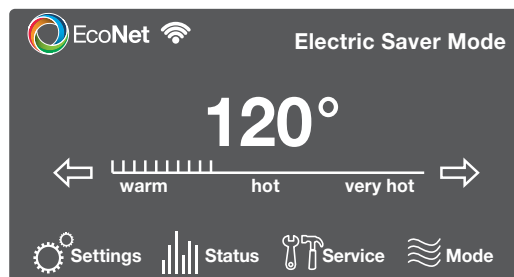

Basic Water Heater Operation

To view the wifi status screen, either tap the wifi icon from the home screen, or go to Status and tap the wifi status button.

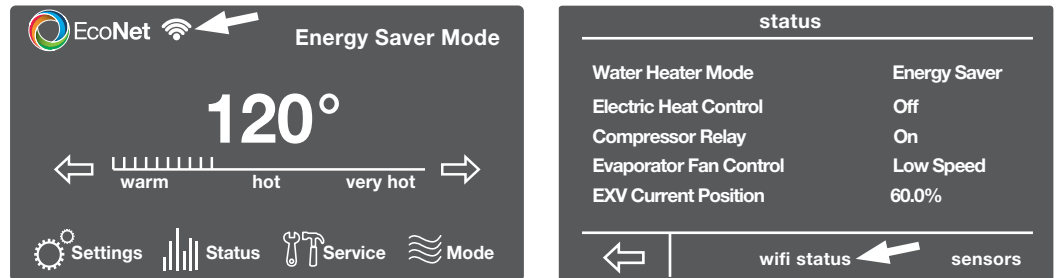

The Wifi Status Screen communicates the following information:

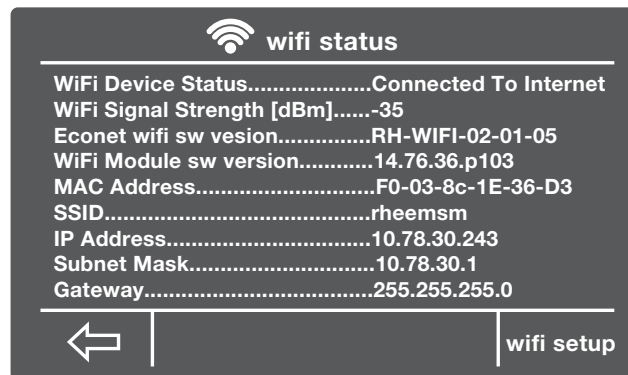

1. Wifi Device Status: This field tells the user the current status of the integrated wifi device. These status' can include:
 - A. WiFi Disabled - tap the wifi setup button to enable wifi on your water heater.
 - B. Ready to Connect - The wifi is ready and can be connected using your mobile device using the Rheem EcoNet app.
 - C. WLAN Connecting - The device is currently connecting to your local wifi network using the credentials provided during setup.
 - D. Connecting to Cloud - The device has connected to the wireless network, and is now connecting via the Rheem EcoNet App.
 - E. Connected to Internet - Your device is connected to the wireless network, and connected to the Rheem EcoNet App.
 - F. Server Connection Error - The water heater is connected to the wireless network, but cannot connect to the Rheem EcoNet App. Please check that your wireless network has access to the internet.
 - G. WLAN Network Not Found - The water heater cannot detect the wireless network provided during setup. Please check that your wireless network is available.
2. WiFi Signal Strength
3. Econet WiFi and WiFi Module software version
4. MAC Address
5. SSID-The name of the wireless network the heater is connecting to.
6. IP Address
7. Subnet Mask
8. Gateway

Care and cleaning of the water heater

Draining the Water Heater

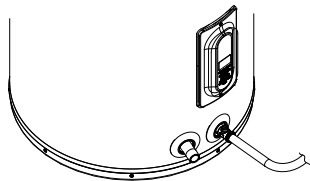

▲CAUTION: Shut off power to the water heater before draining water.

▲DANGER: Before manually operating the relief valve, make certain no one will be exposed to the hot water released by the valve. The water drained from the tank may be hot enough to present a scald hazard and should be directed to a suitable drain to prevent injury or damage.

In order to drain the water heater, turn off the cold water supply. Open a hot water faucet or lift the handle on the relief valve to admit air to the tank.

Attach a garden hose to the drain valve on the water heater and direct the stream of water to a drain. Open the valve.

Routine Preventative Maintenance

Properly maintained, your water heater will provide years of dependable trouble-free service.

It is suggested that a routine preventive maintenance program be established and followed by the user.

Most electrical appliances, even when new, make some sound when in operation. If the hissing or singing sound level increases excessively, Contact a qualified installer or plumbing contractor to inspect.

IMPORTANT: See "DANGER on left". At least once a year, lift and release the lever handle on the temperature pressure relief valve, located on the side of the water heater, to make certain the valve operates freely. Allow several gallons to flush through the discharge line to an open drain.

It is recommended to clean the filter on top of the heat pump when "Clean filter reminder" alert appears. Clean by washing with mild detergent and water. Dry and replace. Remove the filter by lifting up, then replace by lowering back into the filter slot on top of the unit. See Figure below.

At least once a year pour a cup of bleach in the access opening of the condensate drain to kill any algae,

mold, or mildew that has formed in the pipe. Ensure the condensate can flow freely; unclog if needed.

A water heater's tank can act as a setting basin for solids suspended in the water. It is therefore not uncommon for hard water deposits to accumulate in the bottom of the tank. It is suggested that a few quarts of water be drained from the water heater's tank every month to clean the tank of these deposits.

Rapid closing of faucets or solenoid valves in automatic water using appliances can cause a banging noise heard in a water pipe. Strategically located risers in the water pipe system or water hammer arresting devices can be used to minimize the problem.

▲DANGER: Before manually operating the relief valve, make certain no one will be exposed to the danger of coming in contact with the hot water released by the valve. The water may be hot enough to create a scald hazard. The water should be released into a suitable drain to prevent injury or property damage.

NOTICE: If the temperature and pressure relief valve on the water heater discharges periodically, this may be due to thermal expansion in a closed water system. Contact the water supplier or your plumbing contractor on how to correct this. **DO NOT** plug the relief valve outlet.

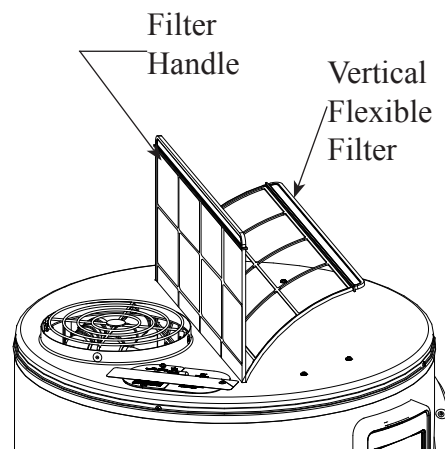

NOTICE: Refer to the Hydrogen Gas Caution in the Operating Instructions.

Vacation and Extended Shut-Down

If the water heater is to remain idle for an extended period of time, the power and water to the appliance should be turned off to conserve energy and prevent a build-up of dangerous hydrogen gas.

The water heater and piping should be drained if they might be subjected to freezing temperatures.

After a long shut-down period, the water heater's operation and controls should be checked by qualified service personnel. Make certain the water heater is completely filled again before placing it in operation.

NOTICE: DO NOT remove the anode rod from the water heater's tank. Operation with the anode rod removed will greatly shorten the life of the glass lined tank and will exclude warranty coverage.

Anode Rod

This water heater is equipped with an anode rod designed to prolong the life of the glass-lined tank. The anode rod is slowly consumed, thereby eliminating or minimizing corrosion of the glass-lined tank.

Water sometimes contains a high sulfate and/or mineral content and together with cathodic protection process can produce a hydrogen sulfide, or rotten egg odor in the heated water. Chlorination of the water supply should minimize the problem.

Before You Call For Service...



Troubleshooting Tips

Save time and money! Review the chart on this page first and you may not need to call for service.

Problem	Possible Causes	What to Do
Rumbling noise	Water conditions in your home caused a build up of scale or mineral deposits in the water heater.	<ul style="list-style-type: none"> ● Allow a few quarts of water to run from drain valve to remove sediment settleings.
Relief valve producing popping noise or draining	Pressure build up caused by thermal expansion in a closed system	<ul style="list-style-type: none"> ● This is an unacceptable condition and must be corrected. Contact the water supplier or plumbing contractor on how to correct this. DO NOT plug the relief valve outlet
Not enough or no hot water	Water usage may have exceeded the capacity of the water heater.	<ul style="list-style-type: none"> ● Wait for the water heater to recover after an abnormal demand
	A fuse is blown or a circuit breaker tripped	<ul style="list-style-type: none"> ● Replace fuse or reset circuit breaker
	Electric supply may be off	<ul style="list-style-type: none"> ● Confirm electric supply to water heater and see installation section of this manual.
	The thermostat may be set too low.	<ul style="list-style-type: none"> ● See the Temperature regulation of the water heater section of this manual
	Leaking or open hot water faucets	<ul style="list-style-type: none"> ● Make sure all faucets are closed
	Electric service to your home may be interrupted	<ul style="list-style-type: none"> ● Contact the local electric utility.
	Improper wiring.	<ul style="list-style-type: none"> ● See the Installing the water heater section of this manual.
	Manual reset limit (ECO)	<ul style="list-style-type: none"> ● See the Temperature regulation of the water heater Refer to page 3 for more information.
	Cold water inlet temperature may be colder during the winter months	<ul style="list-style-type: none"> ● This is normal. The colder inlet water takes longer to heat.
Not enough air exchange for Efficient Heat Pump Operation.	<ul style="list-style-type: none"> ● If air temperature drops more than 15°F during Heat Pump Operation, more air circulation around heater is needed. 	
Water is too hot	The thermostat is set too high.	<ul style="list-style-type: none"> ● See the Temperature regulation of the water heater section of this manual

⚠ CAUTION: For your safety **DO NOT** attempt repair of electrical wiring, thermostats, heating elements or other safety devices. Refer repairs to qualified service personnel.

Troubleshooting Alarm Codes



Troubleshooting Tips

Save time and money! Review the chart on this page first and you may not need to call for service.

The water heater will make an audible beep for notification of Alarms. The following steps should be used in determining the Alarm code:

- 1) Press Blinking "Service" Button on the Home Screen

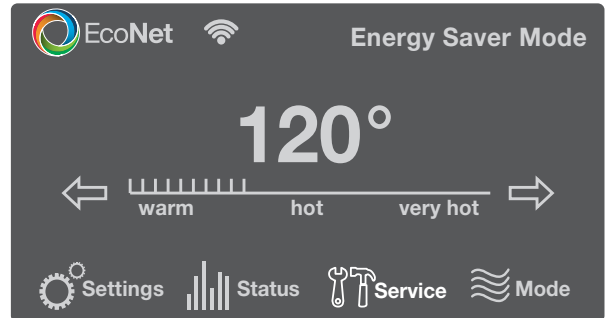

- 2) Press Blinking "alarms" Button on the Service Screen

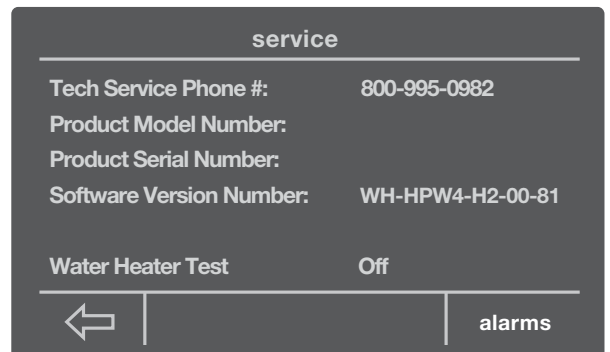

- 3) Alarm will be listed on alarms Screen*.

* A101 Alarm shown as an example. During normal operation, there should not be any alarm listed under "Current Alarms".

The following page details Alarm codes.

More information is available by selecting alarm and then pressing "more info".

Current Alarm **History of all Alarms. (up to 6 Alarms)**

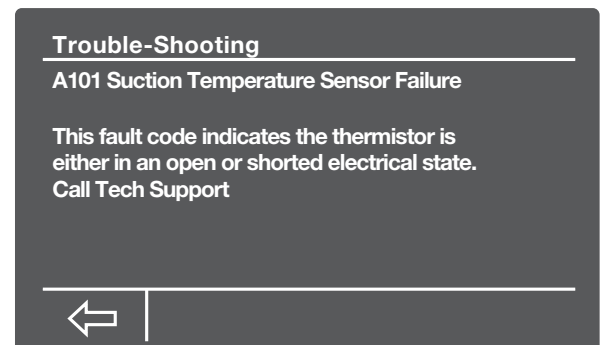
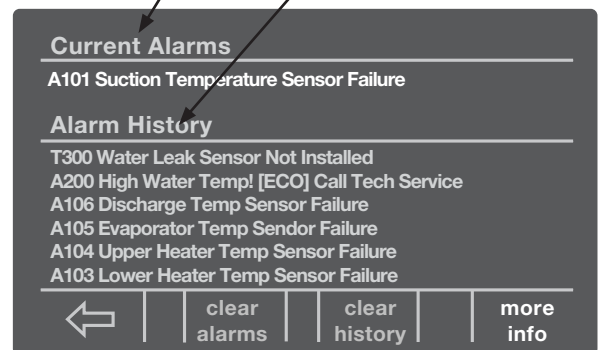

Code	Description	Heater Function	What To Do
A004	Compressor Shutdown: Discharge-Suction Trip.	Heating source defaults to elements due to compressor malfunction.	Call Tech Support at 1-800-995-0982.
T005	Compressor Shutdown: Discharge Temp High.		
A006	Suction Temperature Too Low.	Heating source defaults to elements due to low air flow.	<ol style="list-style-type: none"> 1. Check air filter and clean if necessary. 2. Check fan operation. 3. Check ducting for blockages (if applicable). 4. Refer to Use and Care Manual. 5. Call Tech Support at 1-800-995-0982.
T007	Compressor Shutdown: Comp.Feedback Failure	Heating source defaults to elements due to compressor malfunction.	Call Tech Support at 1-800-995-0982.
A007	Compressor Shutdown: Comp.Feedback Failure.		
A008	Detected Dry Fire Condition.	Dry Fire Protection-- Not sufficient water in the storage tank. Heater disabled.	<ol style="list-style-type: none"> 1. Fill storage tank with water. 2. Purge all air from the storage tank by running a hot water faucet. 3. Refer to Use and Care Manual. 4. Call Tech Support at 1-800-995-0982.
T009	Compressor wiring may be faulty.	Heating source defaults to elements due to compressor malfunction.	Call Tech Support at 1-800-995-0982.
A101	Suction Temperature Sensor Failure.	Heating source defaults to elements due to heat pump temperature sensor malfunction.	
A102	Ambient Temperature Sensor Failure.		
A103	Lower Heater Temp Sensor Failure.	Lower Tank Temperature Sensor malfunction. Heater disabled.	
A104	Upper Heater Temp Sensor Failure.	Upper Tank Temperature Sensor malfunction. Heater disabled.	
A105	Evaporator Temp Sensor Failure.	Heating source defaults to elements due to heat pump temperature sensor malfunction.	
A106	Discharge Temp Sensor Failure.		
A107	Water Detected on Floor: Check for Leaks.	Water is detected in the drain pan.	
A108	Condensate Blocked: Unclog Line.	Heating source defaults to elements due to condensate drain blockage.	<ol style="list-style-type: none"> 1. Clean condensate drain. 2. Refer to Use & Care Manual 3. Call Tech Support at 1-800-995-0982.
A125	Lower Element Error or Relay Stuck Closed.	Heating element or Control board failure. Heater disabled.	<ol style="list-style-type: none"> 1. Disconnect power to unit. 2. Call Tech Support at 1-800-995-0982.
A126	Upper Element Error or Relay Stuck Closed.		
A127	Element Wire Routing Error .	Elements mis-wired or control board failure. Heater disabled.	<ol style="list-style-type: none"> 1. Disconnect power to unit. 2. Contact your installer/contractor to rewire elements properly. 3. Call Tech Support at 1-800-995-0982
A128	Lower Element Relay Failure to Close Error.	Control board relay failure. Heater Disabled.	Call Tech Support at 1-800-995-0982.
A129	Upper Element Relay Failure to Close Error.		
A130	Unit Off/Air Temp Freezing: Enable Unit.	Ambient temperature below freezing. --FREEZE WARNING	Select mode to enable heater.
T131	Clean Filter Reminder	Air filter routine maintenance reminder.	<ol style="list-style-type: none"> 1. Set mode to Electric or Off. 2. Remove air filter and clean by washing with mild detergent. 3. Dry air filter and reinstall. 4. Set unit to desired mode.
T132	Water Heater difficulty satisfying demand.	Water Heater cannot satisfy demand.	<ol style="list-style-type: none"> 1. Check for open faucets. 2. Check for water leaks. 3. Refer to Use & Care Manual. 4. Call Tech Support at 1-800-995-0982.

Troubleshooting Alarm Codes Cont.

Code	Description	Heater Function	What To Do
A200	High Water Temp! [ECO].	ECO Tripped. Heater disabled.	<ol style="list-style-type: none"> 1. Disconnect power to unit. 2. Refer to Use and Care Manual. 3. Call your installer/contractor. 4. Call Tech Support at 1-800-995-0982.
T300	Water Leak Sensor Not Installed.	Water Leak Sensor Not Installed.	<ol style="list-style-type: none"> 1. Install Water Leak Sensor 2. Refer to Use and Care Manual.
A900	Controller Fault.	Controller Malfunction. Heater disabled.	Call Tech Support at 1-800-995-0982.
T901			
A902			
A903			
A904			
A905			

Replacement Parts.

Instructions For Placing a Parts Order

Address parts orders to the distributor or store where the heater was purchased.

All parts orders should include:

- 1 The model and serial number of the water heater from the rating plate located on the tank jacket.
- 2 Specify voltage and wattage as marked on the rating plate.
- 3 Part description (as noted below) and number of parts desired.

***NOTICE:** Check the water heater's rating label on the front of the unit for the acceptable element wattage.

▲CAUTION: For your safety **DO NOT** attempt repair of electrical wiring, heating elements, heat pump or electronic controls. Refer repairs to qualified service personnel.

▲WARNING!
FLAMMABLE CONTENTS UNDER PRESSURE. The compressor is not a serviceable part. The compressor wiring terminals may arc allowing pressurized refrigerant and oil to escape, ignite and cause serious bodily injury, severe burns or death.

Available Replacement Parts	
Part #	Description
AP17344	Air Filter
AP17967	Capacitor
AS38409	Cavity Cover
AP17940	Condensate water sensor
AP18553	Controller Assembly*
AP16830D	Drain Valve
AP18708JL	Element (2250W)
AP10869NM	Element (5000W)
AS23557	Element Bracket
AP18296	EXV solenoid w/wiring
AP17455	Faceplate
AS46605	Fan Assembly
AP18217	Fan Motor
AP16581A	Inlet Diffuser Tube
AS46443	Lower Thermistor
SP8878N	Outlet J-tube
AP14837G	Temperature & Pressure Relief Valve
AP18087	Thermistor
AS46442	Upper Thermistor & ECO Assembly
AP17980	Water Leak Sensor
AP19134	
AP17512	Wiring Harness for Heat Pump Thermistors

Service Part Options for AP18553	
SP18553A	30 Amp model option
SP18553B	15 Amp model option

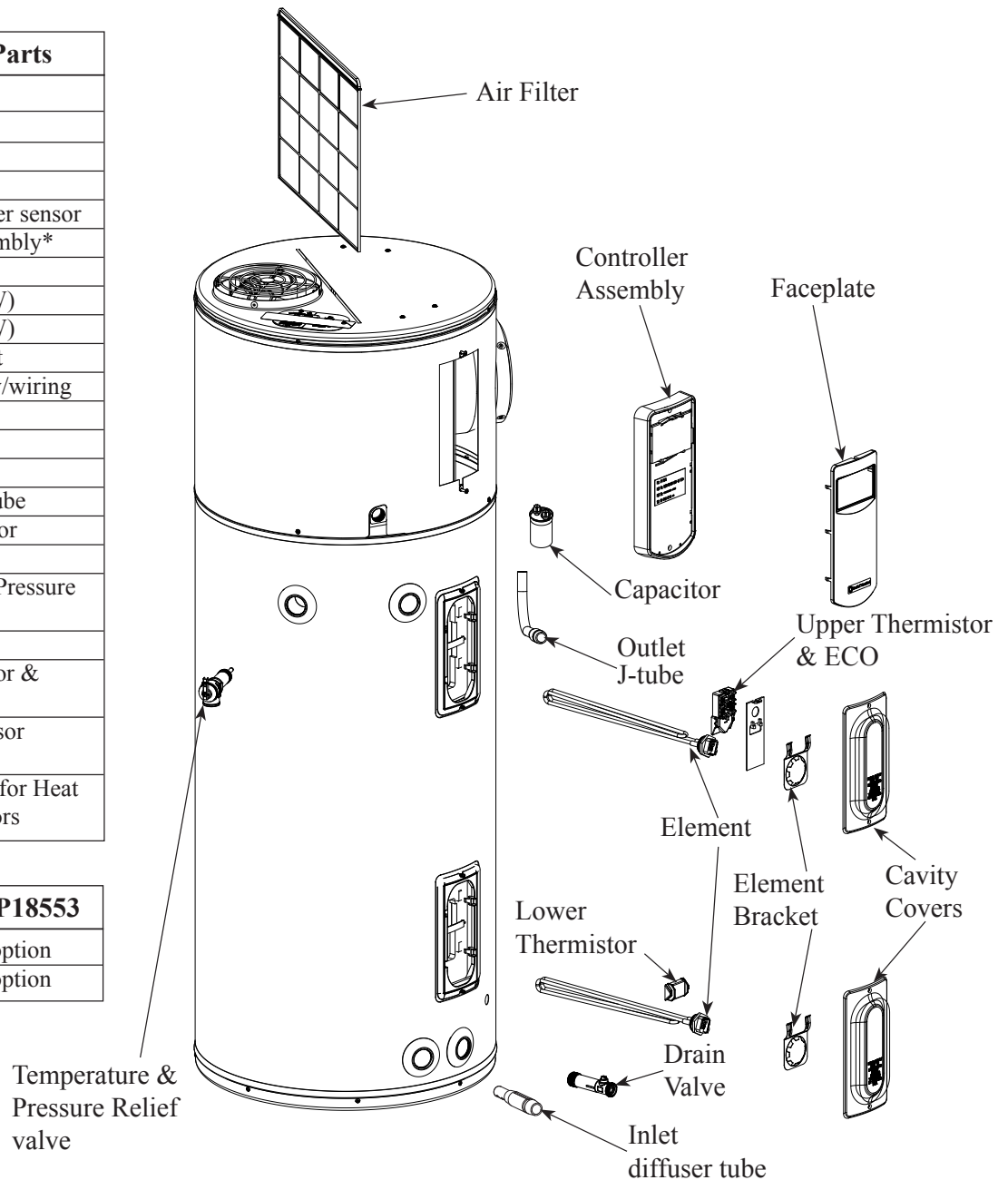

Cavity Insert Instructions

The following instructions are intended for qualified service personnel **ONLY**, and should only be done when necessary.

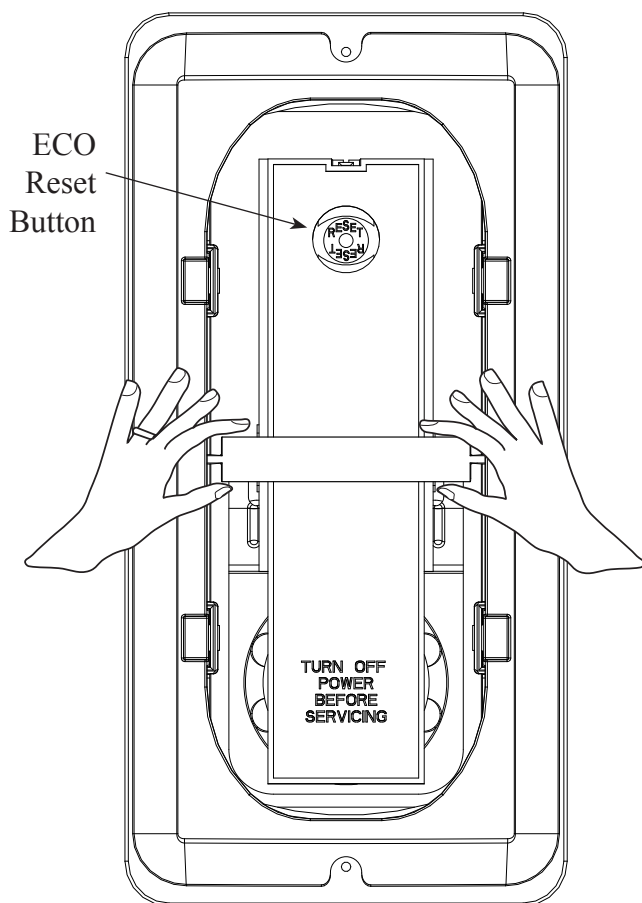

In order to replace the ECO,thermistor or heating element, remove the cavity insert crossbar by following the instructions below:

- 1 Disconnect all power to unit before to starting maintenance.
- 2 Remove the jacket access panel(s) and insulation.
- 3 Rotate the crossbar up and down until it breaks away from the remainder of the cavity insert. (See illustration to the left)
- 4 Discard the crossbar. It cannot and need not be replaced.

Replace the ECO,thermistor and/or element as necessary.

- 5 Replace the insulation, jacket access panel(s) and plastic housing before turning on the power to the water heater.

NOTICE: The cavity insert crossbar is necessary for the manufacturing process only. The removal of the crossbar will not interfere with the operation of the water heater.

Wiring Diagram

WIRING DIAGRAM

* ON SOME MODELS ONLY

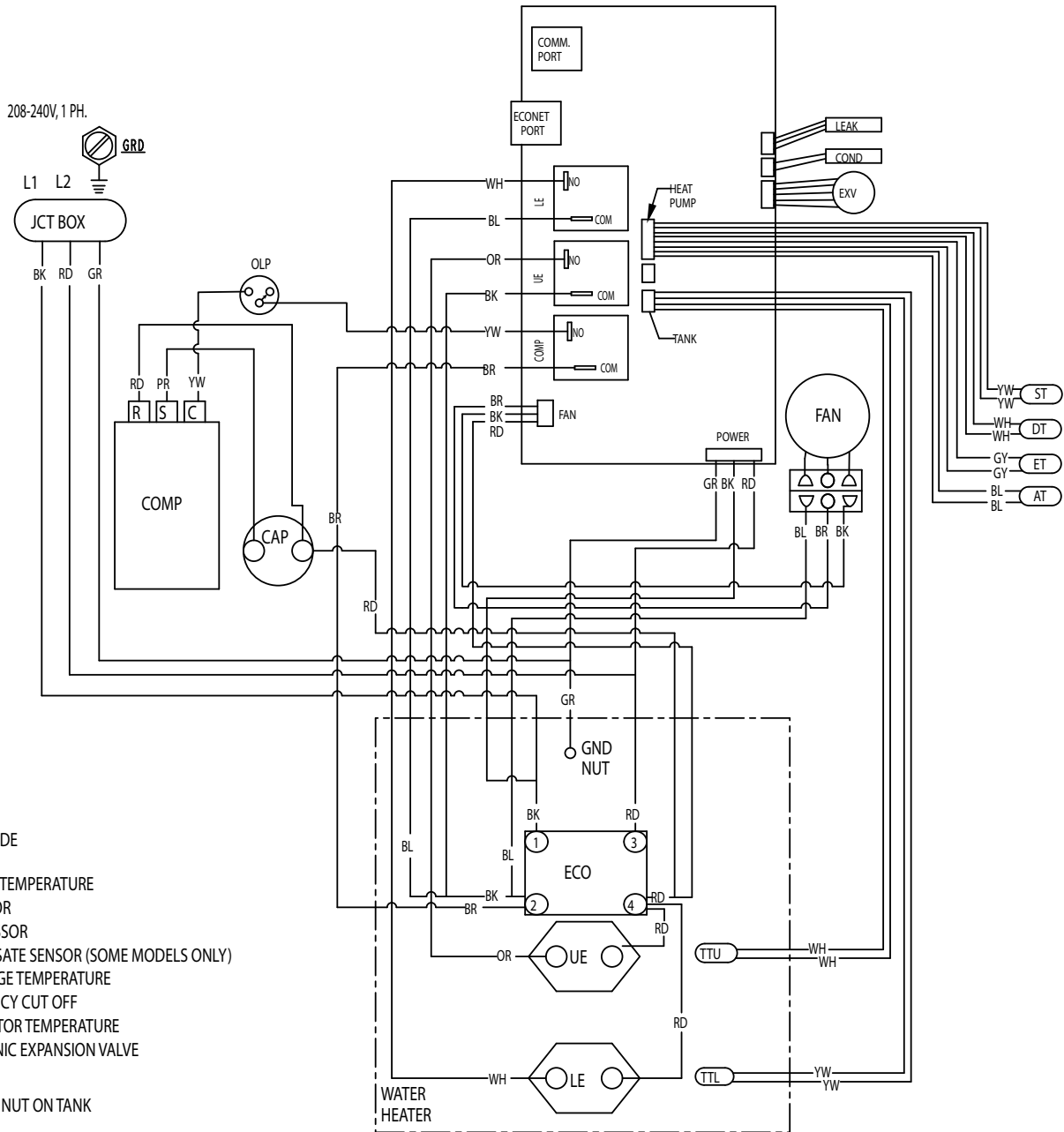

COMPONENT CODE

- AT AMBIENT TEMPERATURE
- CAP CAPACITOR
- COMP COMPRESSOR
- COND CONDENSATE SENSOR (SOME MODELS ONLY)
- DT DISCHARGE TEMPERATURE
- ECO EMERGENCY CUT OFF
- ET EVAPORATOR TEMPERATURE
- EXV ELECTRONIC EXPANSION VALVE
- FAN FAN
- GND NUT GROUND NUT ON TANK
- HPS HIGH PRESSURE SWITCH
- JCT BOX JUNCTION BOX
- LE LOWER ELEMENT
- LEAK LEAK SENSOR (SOME MODELS ONLY)
- OLP OVERLOAD PROTECTOR
- PCB PROGRAMMED CONTROL BOARD
- ST SUCTION TEMPERATURE
- TB TERMINAL BLOCK
- TTL TANK TEMPERATURE - LOWER
- TTU TANK TEMPERATURE - UPPER
- UE UPPER ELEMENT

Notes:

Notes:

IF YOU NEED SERVICE



1. Should you have any questions about your new water heater, or if it requires adjustment, repair, or routine maintenance, it is suggested that you first contact your installer, plumbing contractor or previously agreed upon service agency. In the event the firm has moved, or is unavailable, refer to the telephone directory, commercial listings or local utility for qualified service assistance.
2. Should your problem not be solved to your complete satisfaction, you should then contact the Manufacturer's National Service Department at the following address:
800 Interstate Park Drive
Montgomery, Alabama 36109
Phone: 1-800-432-8373.

When contacting the manufacturer, the following information will be requested:

- a. Model and serial number of the water heater as shown on the rating label located on front of the water heater.
- b. Address where the water heater is located and physical location.
- c. Name and address of installer and any service agency who performed service on the water heater.
- d. Date of original installation and dates any service work was performed.
- e. Details of the problems as you can best describe them.
- f. List of people, with dates, who have been contacted regarding your problem.