



The new degree of comfort.®

Professional *Prestige*® Hybrid Electric is the most efficient water heater available

Efficiency

- High 3.55 - 3.70 UEF reduces operating cost
- ENERGY STAR® rated

Performance

- Delivers hot water faster than most standard electric water heaters – 67 gallons first-hour delivery for 50-gallon model, 75 gallons FHD for 65-gallon model and 89 gallons FHD for 80-gallon model (30 Amp models)
- Ambient operating range: 37-145° F is widest in class, offering more days of HP operation annually; designed to meet Northern Climate Spec (Tier 3)

Easy Installation

- Easy access side connections
- Quick access to electrical junction box
- Easily replaces a standard electric water heater

Integration

- LCD Screen with built-in water sensor alert with audible alarm



- Integrated EcoNet® WiFi-connected* technology and free mobile app gives users control over water systems, allowing for customizable temperature, vacation settings, energy savings and system monitoring at home or away. Visit Rheem.com/hybridsolutions
- Water sensor detects water outside of the unit and sends an alert via the free Rheem EcoNet® mobile app to the homeowner

Operation Modes

- Energy Saver
- Heat Pump
- High Demand
- Electric
- Vacation: 2-28 days (or placed on hold indefinitely)

Plus...

- Premium grade anode rod with resistor extends the life of the tank
- 3/4" NPT water inlet and outlet; 3/4" condensate drain connections
- Incoloy stainless steel resistor elements
- Dry-fire protection
- Easy access, top mounted washable air filter
- 2" Non-CFC foam insulation
- Enhanced flow brass drain valve
- Temperature and pressure relief valve installed
- Low lead compliant

Warranty

- 10-Year limited tank and parts warranty
See Residential Warranty Certificate for complete information

Units meet or exceed ANSI requirements and have been tested according to D.O.E. procedures. Units meet or exceed the energy efficiency requirements of NAECA, ASHRAE standard 90, ICC Code and all state energy efficiency performance criteria.

*WiFi broadband internet connection required.



Professional *Prestige* Hybrid

50, 65 and 80-Gallon Capacities
208-240 Volt / 1 PH
Electric



LEED Points = 3

See specifications chart on next page.



Professional *Prestige*® Hybrid Specifications

DESCRIPTION				ENERGY INFO		FEATURES				TANK DIMENSIONS (SEE SPACE REQUIREMENTS IN DIAGRAMS BELOW)						
NOMINAL GALLON CAPACITY	RATED GALLON CAPACITY	MODEL NUMBER	MODEL VARIANT	ELECTRIC BREAKER SIZE	UNIFORM ENERGY FACTOR (UEF)	ESTIMATED YEARLY ENERGY COST	COMPRESSOR BTU/H	SOUND LEVEL (dBA)	UEF FIRST HR. RATING G.P.H.	RECOVERY IN G.P.H. 90° F RISE	HEIGHT A	DIAM. B	HT. TO COLD INLET & DRAIN VALVE	HT. TO HOT OUTLET & T&P	UNIT WT. (LBS)	APPROX. SHIP WT. (LBS.)
NEW!	50	PROPH50 T2 RH350 DCB	692104	30	3.55	\$110	4200	49	67	29	61"	22-1/4"	3-5/8"	39-5/8"	178	218
	50	PROPH50 T2 RH350 D	694030	15	3.55	\$110	4200	49	53	16	61"	22-1/4"	3-5/8"	39-5/8"	178	218
NEW!	65	PROPH65 T2 RH350 DCB	692111	30	3.70	\$161	4200	49	75	29	64"	24-1/4"	3-7/8"	42-3/8"	225	262
	65	PROPH65 T2 RH350 D15	694146	15	3.55	\$110	4200	49	53	16	64"	24-1/4"	3-7/8"	42-3/8"	225	262
NEW!	80	PROPH80 T2 RH350 DCB	692128	30	3.70	\$161	4200	49	89	29	74"	24-1/4"	3-7/8"	52-3/8"	244	281
	80	PROPH80 T2 RH350 D15	694054	15	3.55	\$110	4200	49	67	16	74"	24-1/4"	3-7/8"	52-3/8"	244	281

Estimated energy cost based on a national average electricity cost of \$0.12 /kWh. Uniform Energy Factor and rated gallon capacity based on Department of Energy (DOE) requirements. All units have integrated WiFi control board.

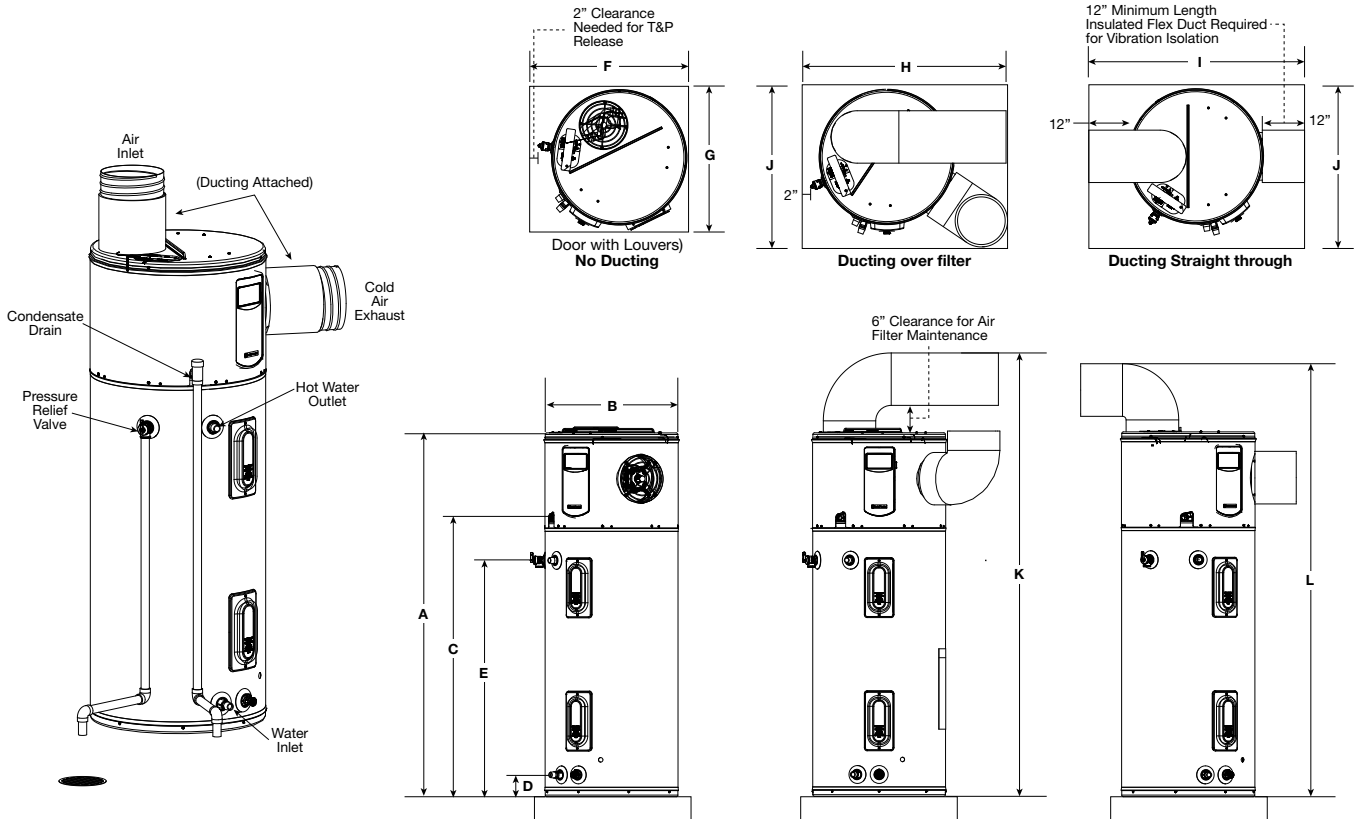

DESCRIPTION		DIMENSIONS (SHOWN IN INCHES)											
NOMINAL GALLON CAPACITY	MODEL NUMBER	A	B	C	D	E	F	G	H	I	J	K	L
50	PROPH50	61	22-1/4	47	3-5/8	39-5/8	28	24	36	50	27	77	73
65	PROPH65	64	24-1/4	49	3-7/8	42-3/8	30	26	38	52	29	80	76
80	PROPH80	74	24-1/4	59	3-7/8	52-3/8	30	26	38	52	29	90	86

Hybrid Water Heater Installation Guidelines to Provide Optimal Efficiency

Heater: Not Ducted

Room size: Larger than 700 ft³ (e.g. 7' x 10' x 10').
 Requirements: No additional ventilation needed.

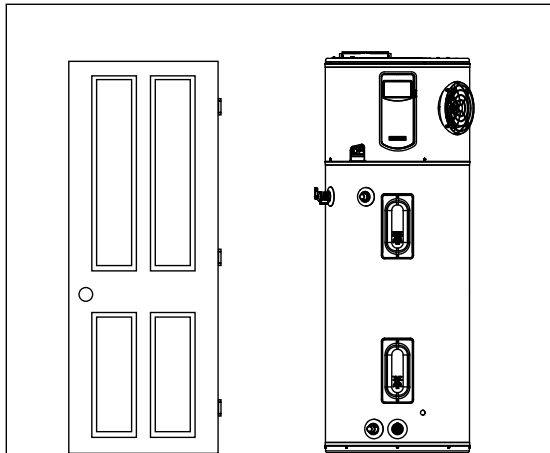

Heater: Not Ducted

Room size: Smaller than 700 ft³ (e.g. 7' x 10' x 10').
 Requirements: Full louvered door OR two louvers top and bottom. See below.

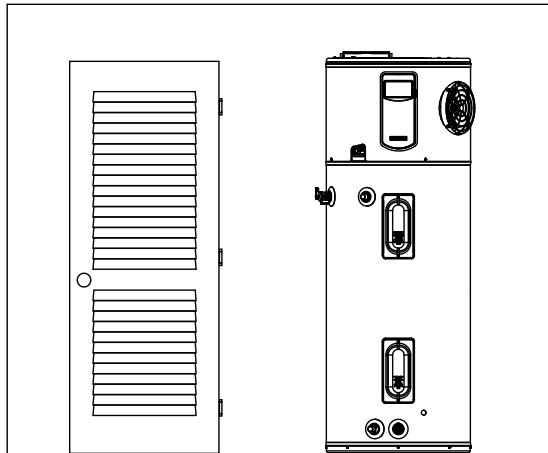

Heater: Not Ducted

Room: Small Closet

Requirements: *Air gap under door equal to 18 in² (0.75" clearance).
 *Louver must be located the same height on door as the air exhaust on heater.
 *Heater air exhaust must be positioned towards louver within one foot of door.

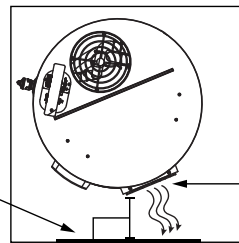
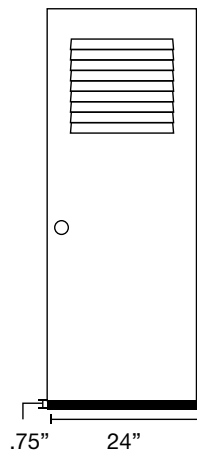

Air exhaust

12" Max Door

Heater: Ducted with inlet OR outlet duct

Room size: Any size room
 Requirements: Air gap under door equal to 18 in² (0.75" clearance)

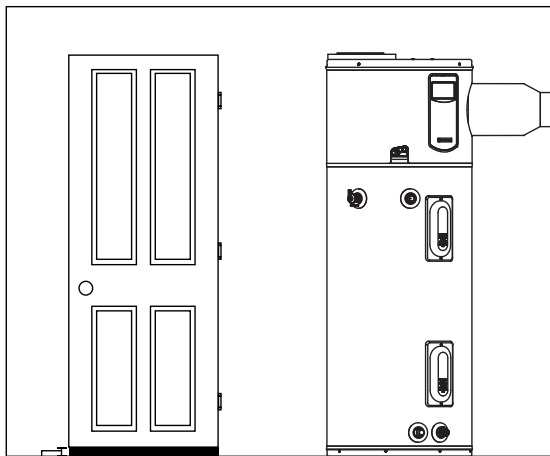

.75" 24"

Heater: Ducted with inlet AND outlet duct

Room size: Any size room
 Requirements: No additional ventilation needed.

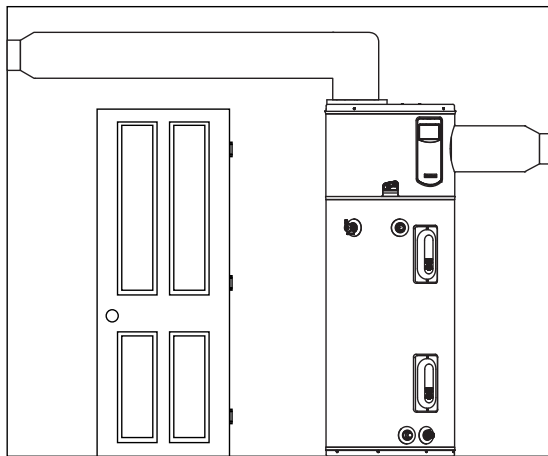



The new degree of comfort®



Residential Electric
Professional *Prestige*
Hybrid Water Heaters

Hybrid Accessories

PART NUMBER	DESCRIPTION	USE FOR
SP20882	Earthquake Isolation Kit	Installations in seismic regions
SP20883	Vibration Isolation Kit	Installation on non-concrete floors
SP20884	8" Diameter UL Certified Termination Kit	Termination to the outside or to the attic with 8" diameter
SP20885	7" Diameter UL Certified Termination Kit	Termination to the outside or to the attic with 7" diameter
SP20886	6" Diameter UL Certified Termination Kit	Termination to the outside or to the attic with 6" diameter
SP20887	5" Diameter UL Certified Termination Kit	Termination to the outside or to the attic with 5" diameter
SP20888	8" Rheem Approved Damper Kit	Exhaust only to the outside ducting configuration (no inlet duct)
SP20889	25' Flexible 8" Diameter Duct Kit	For up to 25' of ducting
SP20890	Rigid Elbow Duct Kit	Installation in tight places where space needs to be minimized



SP20882



SP20883

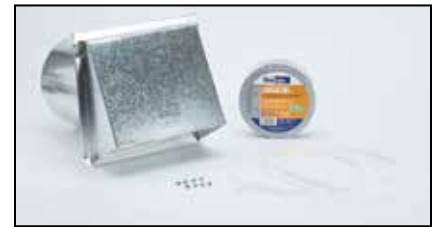

SP20884



SP20885



SP20886



SP20887



SP20888



SP20889



SP20890

In keeping with its policy of continuous progress and product improvement, Rheem reserves the right to make changes without notice.

Rheem Water Heating • 1115 Northmeadow Parkway, Suite 100
Roswell, Georgia 30076 • www.rheem.com

Rheem Canada Ltd./Ltée • 125 Edgeware Road, Unit 1
Brampton, Ontario L6Y 0P5 • www.rheem.com



INTEGRATED HOME COMFORT