

# User Manual



VB0038

## HRV / ERV Ventilation Systems

---

### PROTECH™ MODELS

---

**84-HRV100**

---

**84-HRV200**

---

**84-ERV100**

---

**84-ERV200**

---

Address of your installer

## ABOUT THIS MANUAL/PRODUCT

The purpose of this manual is to help you with the use of your unit. Section 2 (How to Operate the Unit Using Controls) shows you how you can operate the unit in no time. Section 3 deals with maintenance and explains how to maintain the unit to ensure maximum operation and performance. In the other sections, for example Troubleshooting, you will learn how to solve minor problems (Section 4); plus other important information which we urge you to read.

Several models are described in this publication. Some details of your unit may be slightly different than the ones shown, as the illustrations are typical ones.

We welcome any suggestions you may have concerning this manual and/or the unit, and we would appreciate hearing your comments on ways to better serve you. Please forward all correspondence to us at the address indicated on the product registration card included with this manual.

This manual uses the following symbols to emphasize particular information:

### **WARNING**

**Identifies an instruction which, if not followed, might cause serious personal injuries including possibility of death.**

### **CAUTION**

**Denotes an instruction which, if not followed, may severely damage the unit and/or its components.**

NOTE: Indicates supplementary information needed to fully complete an instruction.

Finally, we want to congratulate you on your purchase of this excellent unit which will allow you and your family to enjoy fresh air throughout your home for years to come!

### **CAUTION**

**Some activities create dust or vapors which may damage your unit. You must therefore turn off and unplug your unit in the following situations:**

- major renovation work
- housing construction
- sanding (e.g. gypsum joints, etc.)
- varnishing

**During very heavy snowstorms, the unit should also be turned off to avoid problems caused by snow entering the unit, even if it is equipped with an anti-gust intake hood.**

---

# TABLE OF CONTENTS

---

<b>1.0</b>	<b>YOUR UNIT AND ITS PURPOSE</b>	<b>4</b>
1.1	<i>Unit Description</i>	4
1.2	<i>Purpose of the Ventilation System</i>	4
1.3	<i>Recovery</i>	5
1.4	<i>Defrosting</i>	6
1.5	<i>Specifications</i>	6
<b>2.0</b>	<b>HOW TO OPERATE THE UNIT USING CONTROLS</b>	<b>7</b>
2.1	<i>Instructions Regarding your Control Devices</i>	7
2.2	<i>Using the ECONOMY Main Control</i>	8
2.3	<i>Using the VALUE Main Control</i>	9-10
2.4	<i>Using the Optional Wall Control</i>	11
<b>3.0</b>	<b>MAINTENANCE</b>	<b>12</b>
3.1	<i>Every Three Months</i>	12-13
3.2	<i>Annual Maintenance (Fall)</i>	14-15
<b>4.0</b>	<b>TROUBLESHOOTING</b>	<b>16</b>

# 1.0 YOUR UNIT AND ITS PURPOSE

## 1.1 UNIT DESCRIPTION

1. Power supply cord
2. Filters
3. Recovery core
4. Condensation tray
5. Fan

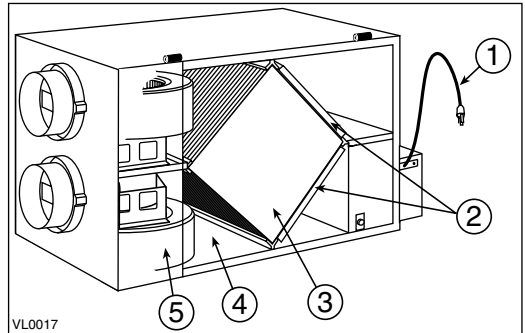

## 1.2 PURPOSE OF THE VENTILATION SYSTEM

Your ventilation system is designed to provide fresh air, warmed outdoor air to your home while exhausting stale, humid air from your home. By eliminating accumulated pollutants and humidity, it maintains an optimum air quality and an ideal relative humidity.

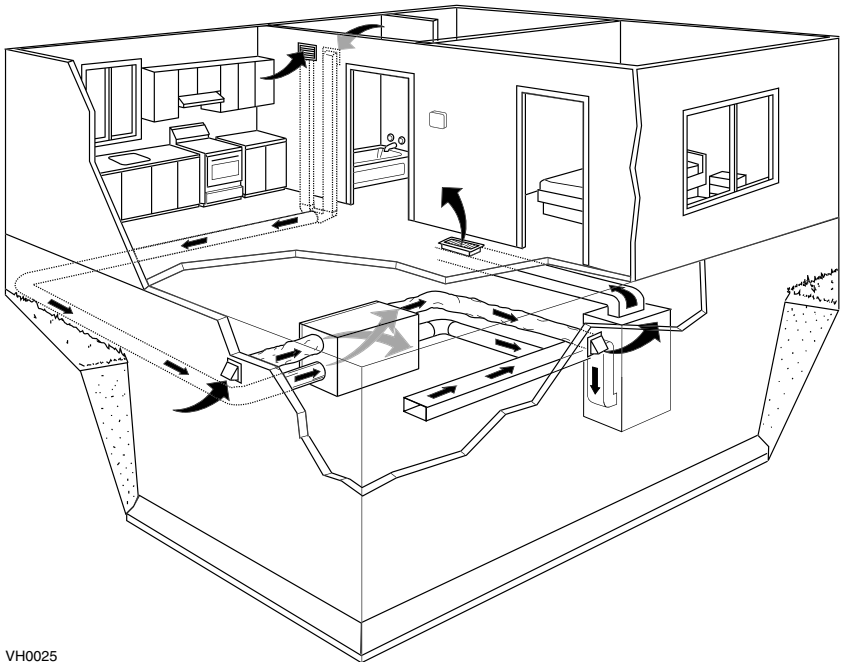

VH0025

- NOTES: 1. Shown with a forced air system. Can also operate on its own.  
2. Installation may vary.

# 1.3 RECOVERY

HRV: Units equipped with a heat recovery core (polypropylene core) are specifically designed to control excess humidity and reduce ventilation costs by recovering the heat energy from the exhausted air, and using that same heat energy to warm the fresh air being supplied. This heat recovery process is accomplished in such a way that the stale air is never mixed with the fresh air.

**Example (in winter):**

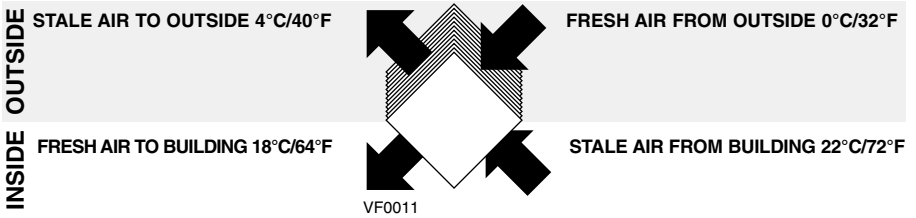

ERV: Units equipped with a heat and humidity recovery core (enthalpic core) can reduce ventilation costs in winter as well as in summer.

1. During the heating season, the unit draws the humidity and heat from the stale air and transfers them, in part, to the cold air entering the house, thus avoiding dryness problems and providing maximum comfort. In order to preserve the structure of the enthalpic core, the unit will only exchange 20 minutes per hour when the temperature drops under -15°C (5°F).

**Example (in winter):**

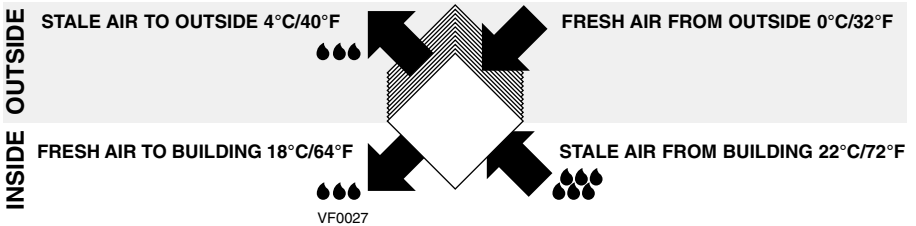

2. During the cooling season, the unit reverses the process, preventing the humidity from the outside air from entering into the house.

**Example (in summer with air conditioning):**

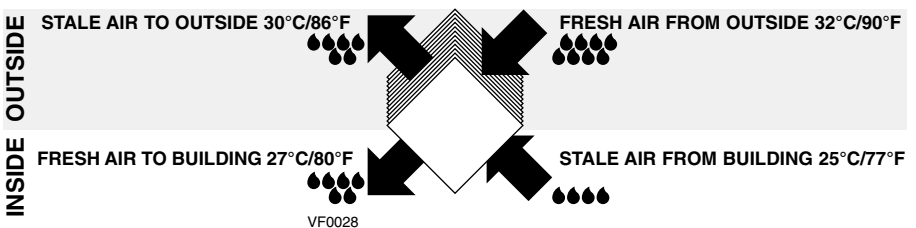

## 1.4 DEFROSTING

---

When the outside temperature is below 0°C (32°F), recovery (of heat or energy) creates frost in the core. To maintain its proper operation, the unit is programmed to defrost the recovery core. The defrost frequency varies according to the outside temperature. Defrosting lasts 6 minutes. During the defrost cycle, the unit shifts to maximum speed and the dampers close.

After defrosting, the unit returns to the operating mode selected by the user.

## 1.5 SPECIFICATIONS

---

<b>Model 84</b>	<b>HRV100 / ERV100</b>
Width	30 1/4" (768 mm)
Height	20" (508 mm)
Depth	13 3/4" (349 mm)
Weight	65 lbs (30 kg)
Electrical Supply	120 V, 60 Hz
Power Consumption	150 Watts

<b>Model 84</b>	<b>HRV200 / ERV200</b>
Width	30 1/4" (768 mm)
Height	20" (508 mm)
Depth	19" (483 mm)
Weight	73 lbs (33 kg)
Electrical Supply	120 V, 60 Hz
Power Consumption	225 Watts

# 2.0 HOW TO OPERATE THE UNIT USING CONTROLS

## 2.1 INSTRUCTIONS REGARDING YOUR CONTROL DEVICES

Determine which controls are installed in your house and identify them in the following table on this page. Then, you can proceed to the pages indicated to learn how to CONTROL your unit.

### MAIN CONTROLS

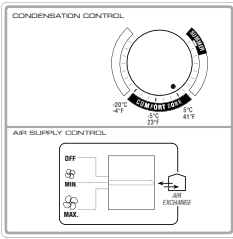

VC0027

**ECONOMY** main control . . . . .Page 8

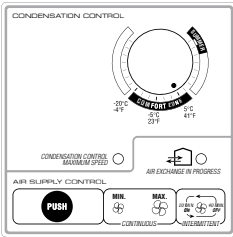

VC0028

**VALUE** main control . . . . .Page 9

### OPTIONAL WALL CONTROL

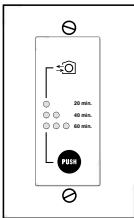

VC0046

20/40/60-min. push-button timer . . . . .Page 11

## 2.2 USING THE ECONOMY MAIN CONTROL

**Location:** Located in the busiest area of the house.

**Purpose:** To adjust air supply and reduce condensation on windows.

### ADJUSTING THE AIR SUPPLY CONTROL

- a) **Select** speed “MIN.” or “MAX.” using switch **A** (as shown on diagram).
- When “MIN.” (minimum speed) is selected, if the knob **B** is set above the click, the unit will exchange in low speed with the outside and if it is set below the click, the unit will exchange on high speed with the outside until the desired humidity level has been reached.
  - When “MAX.” (maximum speed) is selected, the unit will exchange on high speed with the outside either if the knob **B** is set below or above the click.
- b) To **turn the unit off**, place selector **A** at the “OFF” position. Optional controls, however, may still be active.

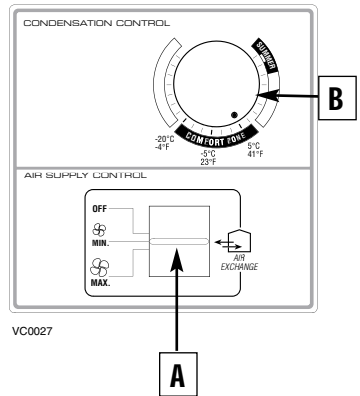

### ADJUSTING THE CONDENSATION CONTROL

#### Setting during the summer months:

Normally there is no condensation on your windows during this period which therefore eliminates the need of the condensation control for a few months. Set knob **B** at the “SUMMER” position during this period.

#### Setting during the fall, winter and spring months:

- 1) Determine the humidity level in your house (bring the knob **B** counterclockwise to -20°C, then bring it back clockwise slowly until you hear a “click”).
- 2) Set knob **B** a notch under this temperature level or “click”.

- NOTES:
1. Do not select a temperature below -20°C. This could lead to excessive dryness in the air causing discomfort for the occupants.
  2. When the humidity level is high, the unit automatically operates at maximum speed. If you change the setting of your “AIR SUPPLY” knob (**B**) at that time, it will remain at maximum speed until the humidity level is reduced, and then switch to the desired setting.

**It is possible (and normal) to experience condensation on your windows when drastic changes in temperature happen (for example: -5°C (23°F) to -20°C (-4°F) within few hours). In that case, we suggest waiting a few days to allow the situation to stabilize.**



## 2.3 USING THE VALUE MAIN CONTROL

**Location:** Located in the busiest area of the house.

**Purpose:** To adjust air supply and reduce condensation on windows.

### ADJUSTING AIR SUPPLY CONTROL

a) Press **“PUSH” (A)** until the **“MIN.”**, **“MAX.”** or **“INTERMITTENT”** light indicator appears.

- When **“MIN.”** (minimum speed) is selected, if the knob **B** is set above the click, the unit will exchange in low speed with the outside and if it is set below the click, the unit will exchange on high speed with the outside until the desired humidity level has been reached.
- When **“MAX.”** (maximum speed) is selected, the unit will exchange on high speed with the outside either if the knob **B** is set below or above the click.
- Select **“INTERMITTENT”** (20 minutes minimum speed exchange every hour) when you are away from the house for a few days or when you deem the inside air too dry.

b) To **turn the unit off**, press **“PUSH” (A)** until the **“MIN.”**, **“MAX.”** and **“INTERMITTENT”** light indicators are all turned off.

**NOTE:** Optional controls will still be active. (Indicator **(C)** will be the only one to light up if an optional control is active).

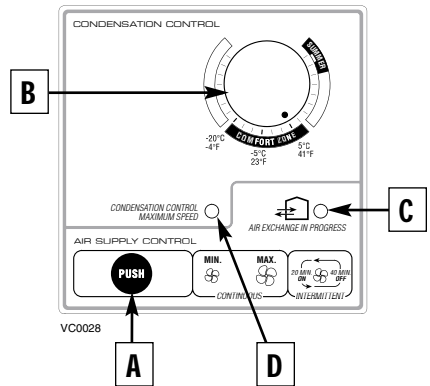

### ADJUSTING CONDENSATION CONTROL

#### Setting during the summer months:

Normally there is no condensation on your windows during this period which therefore eliminates the need of the condensation control for a few months. Set knob **B** at the **“SUMMER”** position during this period.

#### Setting during the fall, winter and spring months:

Ideally, maintain humidity level within the **“Comfort Zone”** (between 5°C and -20°C), which is the dark area around knob **B**.

To reduce humidity level, turn knob **B** clockwise a notch below the click. The unit will then switch to high speed, lighting up the **humidity light (D indicator)**. When this light goes "OFF" (after a few hours or a few days), repeat the same procedure if excess humidity persists.

**NOTE:** If the air is too dry, set your knob **B** back to the **“Comfort Zone”** and use **INTERMITTENT** or turn off the unit.

When the **humidity light (D indicator)** goes "ON", you can still change the mode of operation but your change will take place only when the light goes OFF.

## 2.3 USING THE VALUE MAIN CONTROL (CONT'D)

### UNDERSTANDING THE LIGHT INDICATORS

**LIGHTS UP** when the control has detected excess humidity. This forces the motor to operate at high speed. The light indicator turns off when the humidity drops to the level associated with the temperature selected on knob **B**.

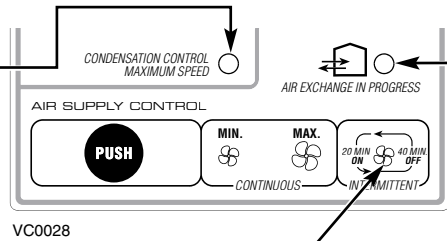

VC0028

**LIGHTS UP** when you have selected the intermittent mode.  
**FLASHES** when maintenance is required (see Section 3).

**LIGHTS UP** when the system is operating (exhausting stale air from the house and drawing in fresh air).  
**FLASHES** when the defrosting cycle is malfunctioning (see Section 3).

## 2.4 USING THE OPTIONAL CONTROL

**Location:** Located in the bathroom or in other locations where there is temporary excess humidity or pollutants.

**Purpose:** To eliminate excess humidity produced by showers or other periodic activities producing pollutants.

### **20/40/60-MINUTE PUSH-BUTTON TIMER:**

Activate the push button. Within 2 seconds, push one time for 20 minutes, two times for 40 minutes or three times for a 60-minute activation.

#### Results expected:

1. Motor speed: high for 20, 40 or 60 minutes.
2. Indicator light goes "ON" and flashes every 5 seconds (one time to indicate a 20-minute operation, two times for a 40-minute, and three times for a 60-minute operation).
3. Air exchange indicator light goes "ON" (VALUE wall control only).

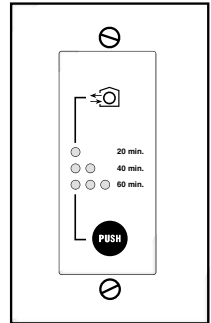

VC0046

**NOTE:** To stop activation, push one more time.

## 3.0 MAINTENANCE

### WARNING

Dangerous voltage may be present. During maintenance and repairs, the unit must always be turned off, then unplugged. We take great care to minimize sharp edges; however, please proceed with caution when handling all components.

### MAINTENANCE PROCEDURE:

#### 3.1 EVERY THREE MONTHS

Regular maintenance should be performed every 3 months. Annual maintenance should also take place every fall season.

1. Disconnect the power supply.
2. Unlatch the door. Lift the panel towards you. Hold it firmly and hit on the right side of the panel. The door should slide to the left.
3. Clean the inside of the **door** with a damp cloth.
4. A) Clean **filters**
  - Remove filters.
  - Vacuum to remove most of the dust.
  - Wash with a mixture of warm water and mild soap. You may add bleach if you wish to disinfect (one tablespoon per gallon). Rinse thoroughly. Shake filters to remove excess water and let dry.

NOTE: Washing the filters in the top tray of the dishwasher is possible, but the aluminum frame might tarnish.

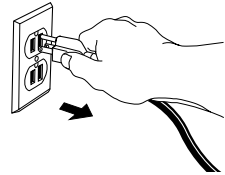

VD0005

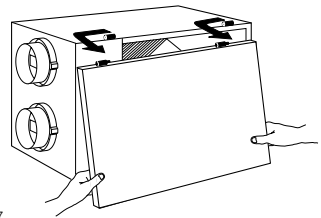

VD0007

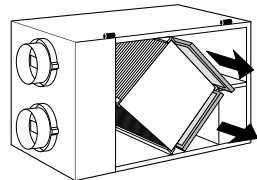

VD0100

### 3.1 EVERY THREE MONTHS (CONT'D)

5. Clean the **condensation tray** with a damp cloth.
6. Check the exterior **air intake hood**:
  - Make sure there are no leaves, twigs, ice or snow that could be drawn into the vent.
  - Clean if necessary.

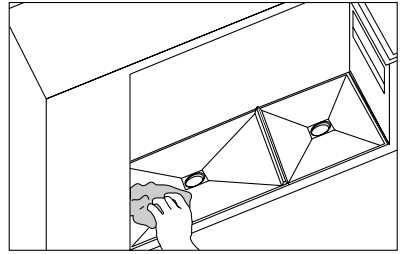

VD0101

#### **CAUTION**

**Even a partial blocking of this air vent could cause the unit to malfunction.**

7. Reassemble the components:
  - Filters
  - Door (The door is secured when you hear a click.)
8. Reconnect the power supply.

## 3.2 ANNUAL MAINTENANCE (FALL)

### WARNING

Dangerous voltage may be present. During maintenance and repairs, the unit must always be turned off, then unplugged.  
We take great care to minimize sharp edges; however, please proceed with caution when handling all components.

Repeat steps 1 to 6 from the previous Section and continue with the following steps:

### CAUTION

Handle the recovery core with care.

#### 1. Clean the recovery core

A- Polypropylene core (heat recovery units: HRV100/HRV200)

- Remove the recovery core.
- Let it soak in a mixture of cold or lukewarm water and mild soap (dishwashing liquid).
- Rinse thoroughly.
- Shake the core to remove excess water and let it dry.

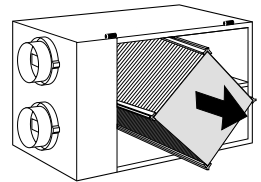

VD0102

B- Enthalpic paper core (heat and humidity recovery units: ERV100/ERV200)

### CAUTION

This type of recovery module cannot be washed with water.

- Remove the recovery core.
- Remove dust using a vacuum cleaner with a soft brush attachment.

#### 2. Clean the centrifugal fan wheels

**A** Remove the wing nut.

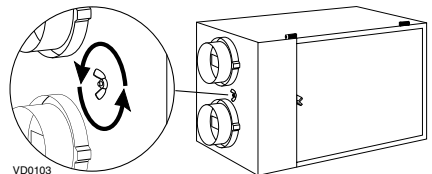

VD0103

**B** Disconnect the fan motor wires.

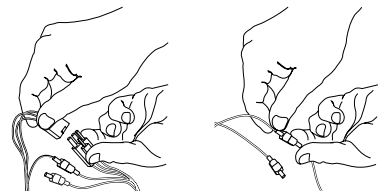

VE0050

## 3.2 ANNUAL MAINTENANCE (FALL) (CONT'D)

---

### 2. Clean the centrifugal fan wheels (cont'd)

---

**C** Remove the fan assembly.

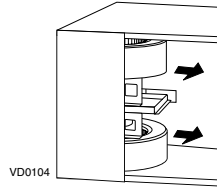

**D** Check for any dust accumulation on the blades.

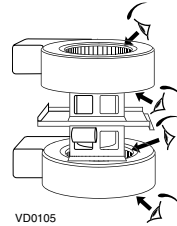

#### CAUTION

**Do not oil the motor! It is already permanently lubricated.**

**E** Clean with a small brush if necessary.

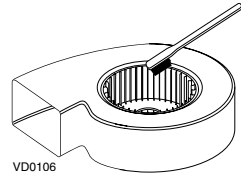

### 3. Put the components back in place:

- Fan assembly (fan motor wires, wing nut)
- Recovery core
- Filters
- Door

### 4. Reconnect the power supply.

## 4.0 TROUBLESHOOTING

If you think your unit is malfunctioning, check some of the following.

	TYPE OF PROBLEM	TRY THIS...
1	Nothing works.	<ul style="list-style-type: none"><li>• See if the unit is plugged in.</li><li>• See if the unit is receiving power from the house circuit breaker or fuse.</li></ul>
2	All light indicators on the wall control are flashing (every 8 seconds).	<ul style="list-style-type: none"><li>• Unplug the unit, wait 30 seconds, then reconnect. If the problem continues, contact your installer.</li></ul>
3	Noisy unit.	<ul style="list-style-type: none"><li>• Clean the fan assembly (see Section 3.2). If the problem continue, contact your installer.</li></ul>
4	Condensation on windows. (Air too humid.)	<ul style="list-style-type: none"><li>• Adjust the humidity control knob as per instructions (see Section 2).</li><li>• Operate the unit at maximum speed (MAX.) during activities generating excess humidity (family gatherings, extra cooking, etc.).</li><li>• Leave curtains half-open to allow air circulation.</li><li>• Store all firewood in a close room with a dehumidifier or in a well ventilated room, or store the wood outside.</li><li>• Keep the temperature in your house above 18°C (64°F).</li></ul>
5	Air too dry.	<ul style="list-style-type: none"><li>• Do not adjust your humidity control below -20°C (-4°F).</li><li>• Operate the unit at low speed (MIN.).</li><li>• Temporarily switch to the intermittent mode.</li><li>• Temporarily use a humidifier.</li></ul>
6	Air too cold at the air supply grille.	<ul style="list-style-type: none"><li>• Make sure the outside hoods are not blocked.</li><li>• Operate the unit at low speed (MIN.).</li><li>• Have the system balancing checked.</li><li>• Have the unit defrost system checked.</li><li>• Install a duct heater.</li></ul>

If the problem persists, contact your installer at the telephone number and address indicated on the first page of this manual or call for your local distributor.