

**Revision B:**

• MSZ-FE09NA - [8] and MSZ-FE12NA - [8] have been added.

Please void OBH542 REVISED EDITION-A.

# INDOOR UNIT SERVICE MANUAL

**No. OBH542**  
REVISED EDITION-B

## Models

|                   |                   |       |
|-------------------|-------------------|-------|
| <b>MSZ-FE09NA</b> | <b>MSZ-FE09NA</b> | - [8] |
| <b>MSZ-FE12NA</b> | <b>MSZ-FE12NA</b> | - [8] |
| <b>MSZ-FE18NA</b> |                   |       |

Outdoor unit service manual  
**MUZ-FE·NA Series (OBH543)**  
**MXZ-A·NA Series (OB444)**  
**MXZ-B·NA Series (OB560)**

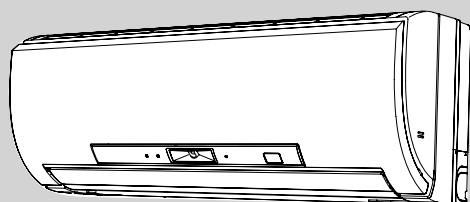

**MSZ-FE09NA**  
**MSZ-FE12NA**



## CONTENTS

|                                     |    |
|-------------------------------------|----|
| 1. TECHNICAL CHANGES.....           | 2  |
| 2. PART NAMES AND FUNCTIONS.....    | 3  |
| 3. SPECIFICATION.....               | 5  |
| 4. OUTLINES AND DIMENSIONS .....    | 6  |
| 5. WIRING DIAGRAM.....              | 7  |
| 6. REFRIGERANT SYSTEM DIAGRAM ..... | 9  |
| 7. SERVICE FUNCTIONS .....          | 10 |
| 8. MICROPROCESSOR CONTROL .....     | 12 |
| 9. TROUBLESHOOTING.....             | 22 |
| 10. DISASSEMBLY INSTRUCTIONS.....   | 36 |

**PARTS CATALOG (OBB542)**

**NOTE:**

RoHS compliant products have <G> mark on the spec name plate.

**Mr. SLIM™**

## Use the specified refrigerant only

### Never use any refrigerant other than that specified.

Doing so may cause a burst, an explosion, or fire when the unit is being used, serviced, or disposed of.

Correct refrigerant is specified in the manuals and on the spec labels provided with our products.

We will not be held responsible for mechanical failure, system malfunction, unit breakdown or accidents caused by failure to follow the instructions.

### Revision A:

- MSZ-FE18NA has been added.

### Revision B:

- MSZ-FE09NA - [8] and MSZ-FE12NA - [8] have been added.

## 1

## TECHNICAL CHANGES

### MSZ-FE09NA

### MSZ-FE12NA

### MSZ-FE18NA

1. New model

**MSZ-FE09NA → MSZ-FE09NA - [8]**

**MSZ-FE12NA → MSZ-FE12NA - [8]**

1. These models have been modified to be compatible with Honeywell remote controller.
2. Indoor electronic control P.C. board has been changed.

## MSZ-FE09NA MSZ-FE12NA

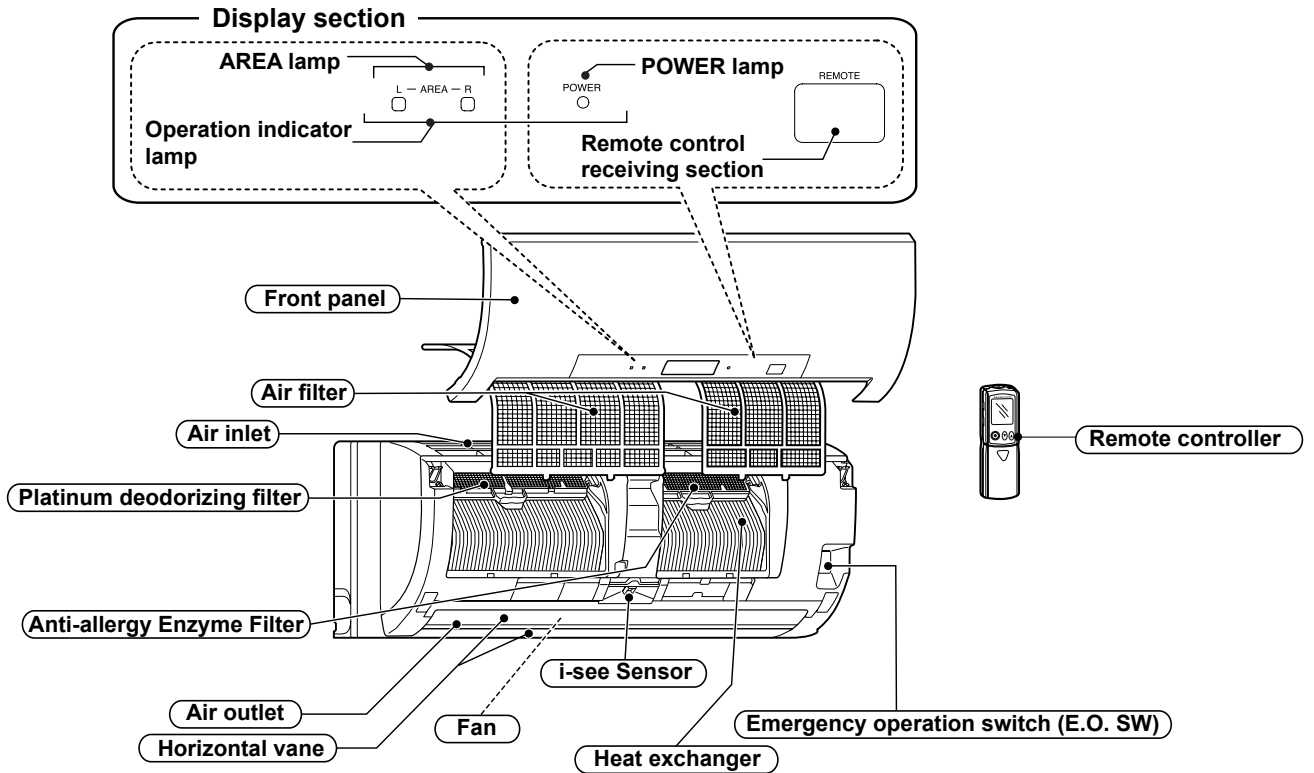
**AREA lamp indicates AREA setting**

In AREA setting, the horizontal air flow direction changes automatically according to the detection of i-see Sensor which detects the floor/wall temperature to air-condition the room evenly.

**i-see control operation**

i-see Sensor constantly measure floor/wall temperature to automatically adjust to the set temperature by estimating the temperature actually perceived by a person inside the room ("sensible temperature").

## MSZ-FE18NA

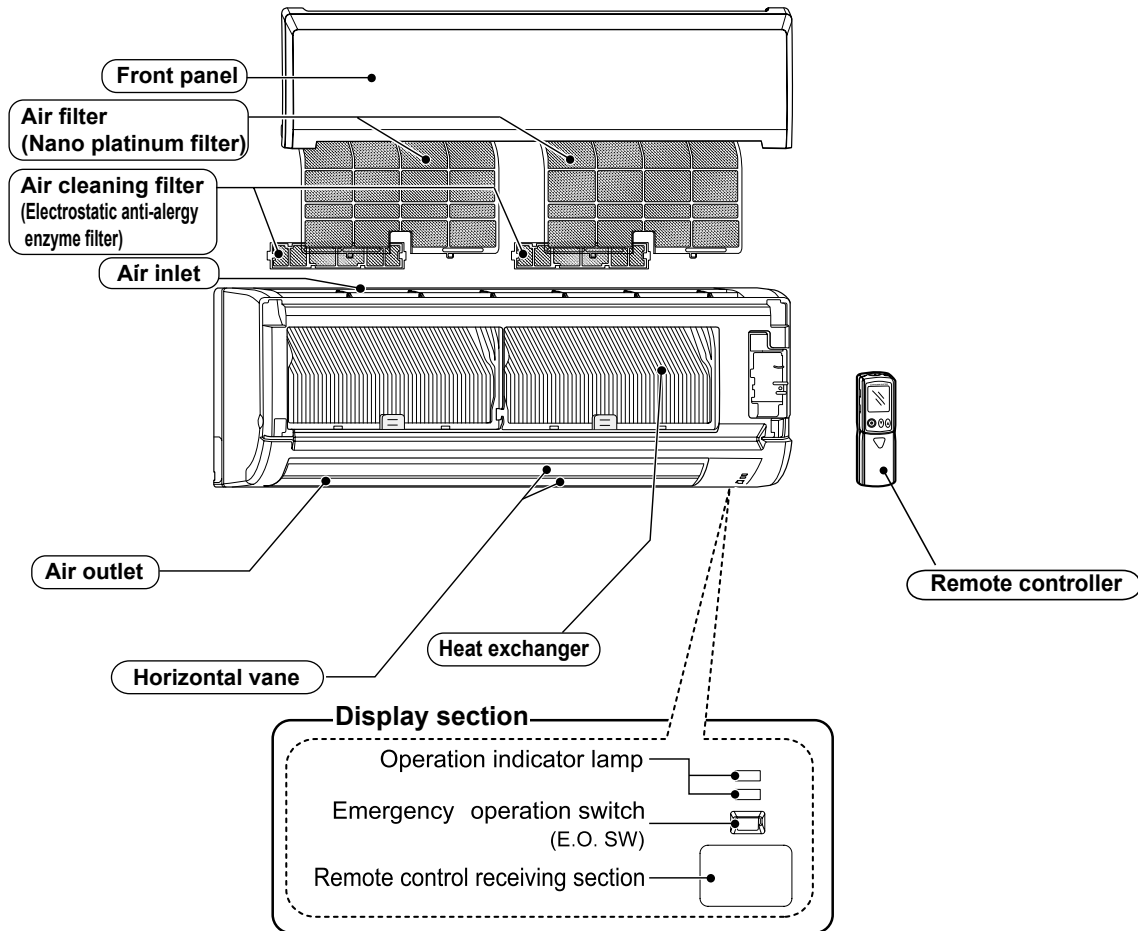

## ACCESSORIES

| Models  | MSZ-FE09/12NA | MSZ-FE18NA |
|---|---------------|------------|
| ① Installation plate                            | 1             | 1          |
| ② Installation plate fixing screw 4 × 25 mm     | 5             | 7          |
| ③ Remote controller holder                      | 1             | 1          |
| ④ Fixing screw for ③ 3.5 × 1.6 mm (Black)       | 2             | 2          |
| ⑤ Battery (AAA) for remote controller           | 2             | 2          |
| ⑥ Wireless remote controller                    | 1             | 1          |
| ⑦ Felt tape (Used for left or left-rear piping) | 1             | 1          |
| ⑧ Air cleaning filter                           | —             | 2          |

# 3

# SPECIFICATION

| Indoor model                                   |                      |       | MSZ-FE09NA                                       | MSZ-FE12NA                                       | MSZ-FE18NA                                       |
|--|----------------------|-------|--|--|--|
| Power supply                                   | V, phase, Hz         |       | 208/230 , 1 , 60                                 |  |  |
| Max. fuse size (time delay)/ Disconnect switch | A                    |       | 15   |  | 20   |
| Min. circuit ampacity                          | A                    |       | 1.0  |  |  |
| Fan motor                                      | F.L.A                |       | 0.76   |  |  |
| Airflow<br>Powerful - High - Med. - Low        | COOL Dry<br>(Wet)    | CFM   | 381 - 339 - 226 - 162<br>(343 - 307 - 202 - 144) | 410 - 381 - 226 - 162<br>(367 - 350 - 202 - 144) | 738 - 628 - 469 - 388<br>(661 - 562 - 420 - 347) |
|  | HEAT Dry             | CFM   | 381 - 367 - 240 - 166                            | 420 - 399 - 240 - 166                            | 738 - 628 - 469 - 388                            |
| Moisture removal                               | pt./h                |       | 2.1  | 2.9  | 2.7  |
| Sound level<br>Powerful - High - Med. - Low    | Cooling              | dB(A) | 42 - 39 - 31 - 22                                | 45 - 43 - 33 - 22                                | 53 - 49 - 41 - 34                                |
|  | Heating              | dB(A) | 42 - 40 - 31 - 22                                | 44 - 43 - 33 - 22                                | 52 - 49 - 41 - 32                                |
| Cond. drain connection O.D.                    | in.                  |       | 5/8  |  |  |
| Dimensions                                     | W                    | in.   | 31-3/8   |  | 43-5/16  |
|  | D                    |       | 10-1/8   |  | 9-3/8  |
|  | H                    |       | 11-5/8   |  | 12-13/16   |
| Weight   | lb.                  |       | 27   |  | 37   |
| External finish                                | Munsell 1.0Y 9.2/0.2 |       |  |  |  |
| Remote controller                              | Wireless type        |       |  |  |  |
| Control voltage (by built-in transformer)      | 12 - 24 VDC          |       |  |  |  |

**NOTE:** Test conditions are based on AHRI 210/240.

### 3-1. OPERATING RANGE

#### (1) POWER SUPPLY

|             | Rated voltage                 | Guaranteed voltage (V) |
|-------------|-------------------------------|------------------------|
| Indoor unit | 208/230 V<br>1 phase<br>60 Hz |                        |

#### (2) OPERATION

| Mode    | Condition            | Intake air temperature (°F) |    |         |     |
|---------|----------------------|-----------------------------|----|---------|-----|
|         |                      | Indoor                      |    | Outdoor |     |
|         |                      | DB                          | WB | DB      | WB  |
| Cooling | Standard temperature | 80                          | 67 | 95      | —   |
|         | Maximum temperature  | 90                          | 73 | 115     | —   |
|         | Minimum temperature  | 67                          | 57 | 14      | —   |
|         | Maximum humidity     | 78%                         |    | —       |     |
| Heating | Standard temperature | 70                          | 60 | 47      | 43  |
|         | Maximum temperature  | 80                          | 67 | 75      | 65  |
|         | Minimum temperature  | 70                          | 60 | -13     | -15 |

### 3-2. OUTLET AIR SPEED AND COVERAGE

| Model      | Mode | Function | Airflow (CFM) | Air speed (ft./s) | Coverage (ft.) |
|------------|------|----------|---------------|-------------------|----------------|
| MSZ-FE09NA | HEAT | Dry      | 381           | 19.2              | 27.7           |
|            | COOL | Dry      | 339           | 17.1              | 24.7           |
|            |      | Wet      | 307           | 15.5              | 22.4           |
| MSZ-FE12NA | HEAT | Dry      | 420           | 21.2              | 30.4           |
|            | COOL | Dry      | 381           | 19.2              | 27.7           |
|            |      | Wet      | 350           | 17.6              | 25.4           |
| MSZ-FE18NA | HEAT | Dry      | 738           | 18.0              | 36.9           |
|            | COOL | Dry      | 738           | 18.0              | 36.9           |
|            |      | Wet      | 661           | 16.1              | 33.2           |

□ The air coverage is the figure up to the position where the air speed is 1 ft./s, when air is blown out horizontally from the unit properly at the High speed position.

The coverage should be used only as a general guideline since it varies according to the size of the room and furniture arranged inside the room.

# 4

# OUTLINES AND DIMENSIONS

## MSZ-FE09NA MSZ-FE12NA

Unit: inch

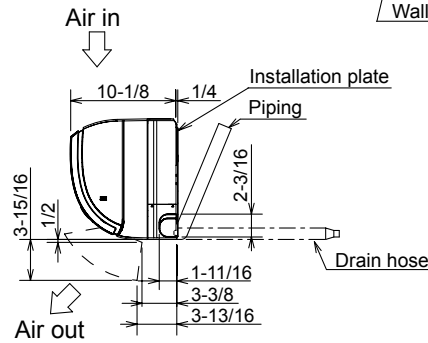
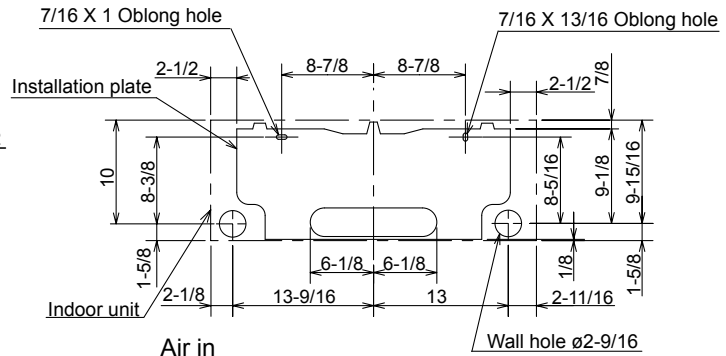
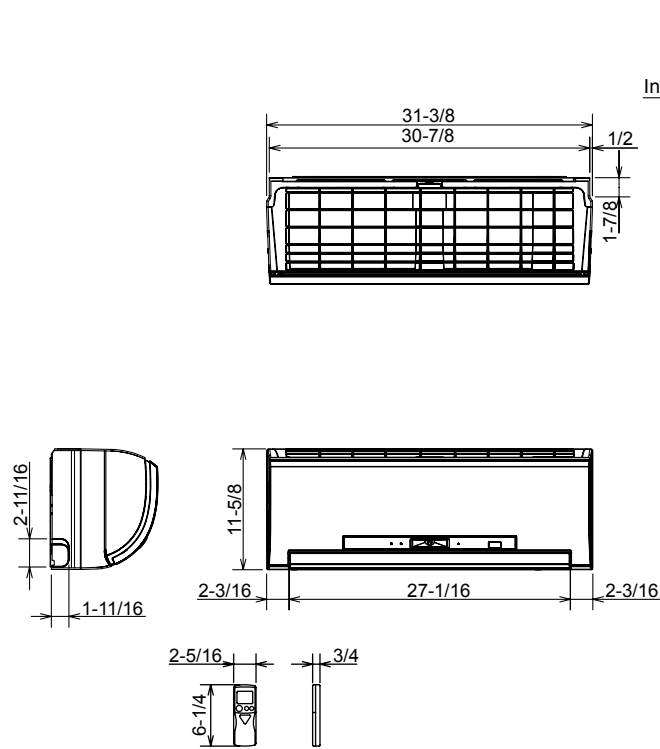

|             |   |
|-------------|---|
| Insulation  | ø1-3/8 O.D                                    |
| Piping      | ø1/4 19-11/16 (Flared connection ø1/4)        |
| Liquid line | ø3/8 16-15/16 (Flared connection ø3/8)        |
| Gas line    | ø3/8 16-15/16 (Flared connection ø3/8)        |
| Drain hose  | Insulation ø1-1/8 O.D Connected part ø5/8 O.D |

## MSZ-FE18NA

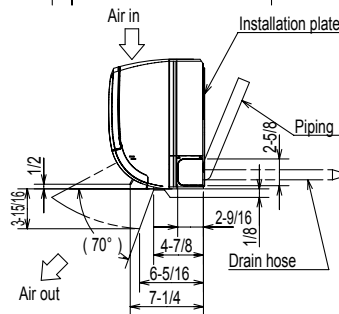
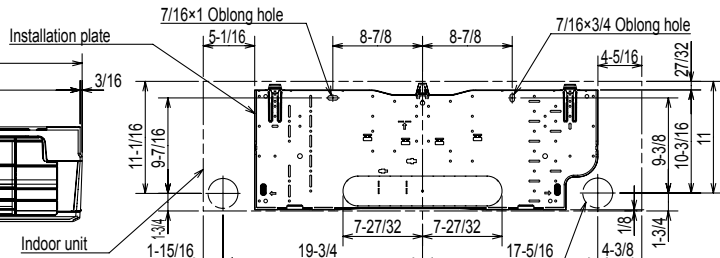
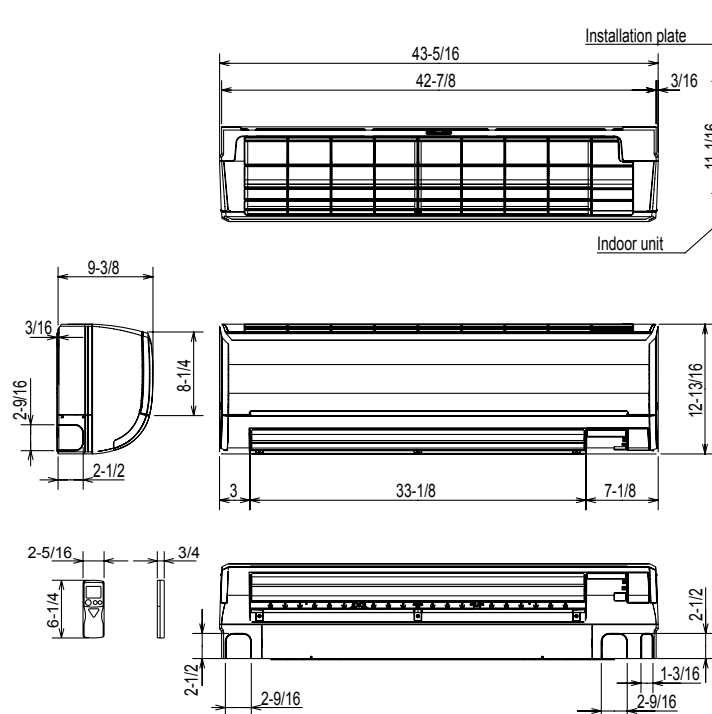

|             |   |
|-------------|---|
| Insulation  | Ø2 O.D                                    |
| Piping      | Ø3/8 19-11/16 (Flared connection Ø3/8)    |
| Liquid line | Ø3/8 19-11/16 (Flared connection Ø3/8)    |
| Gas line    | Ø1/2 16-15/16 (Flared connection Ø5/8)    |
| Drain hose  | Insulation Ø1-1/8 Connected part Ø5/8 O.D |

# 5

# WIRING DIAGRAM

## MSZ-FE09NA MSZ-FE12NA

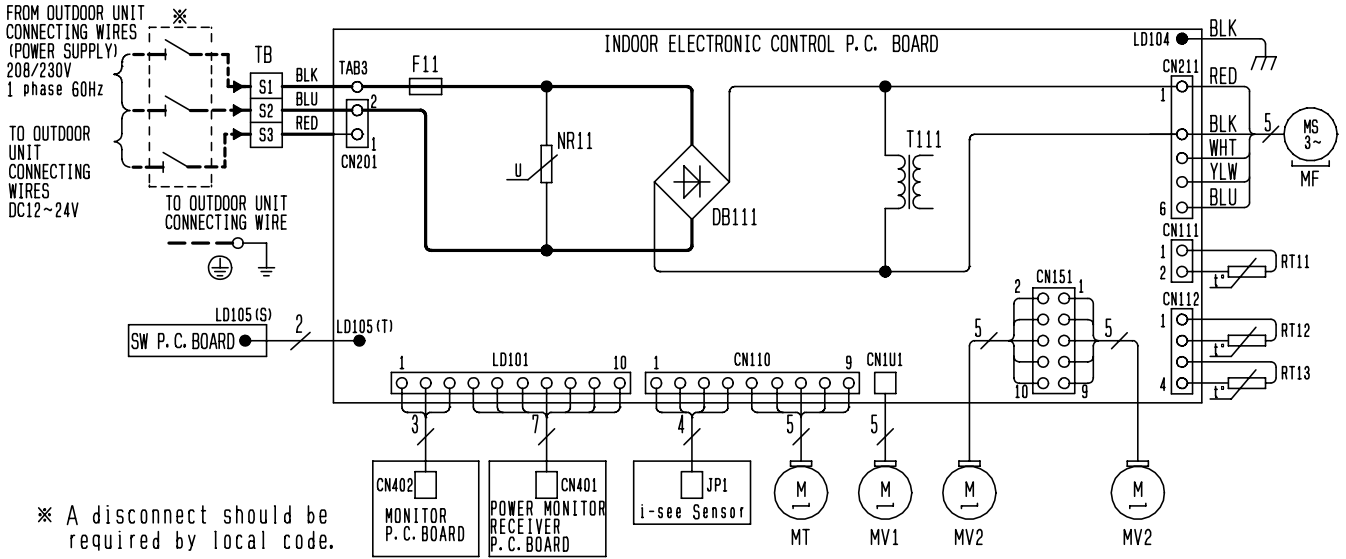

| SYMBOL | NAME                    | SYMBOL | NAME                         |
|--------|-------------------------|--------|------------------------------|
| DB111  | DIODE STACK             | NR11   | VARISTOR                     |
| F11    | FUSE (T3. 15A/250V)     | RT11   | ROOM TEMP. THERMISTOR        |
| MF     | FAN MOTOR               | RT12   | COIL TEMP. THERMISTOR (MAIN) |
| MT     | i-see Sensor MOTOR      | RT13   | COIL TEMP. THERMISTOR (SUB)  |
| MV1    | VANE MOTOR (HORIZONTAL) | T111   | TRANSFORMER                  |
| MV2    | VANE MOTOR (VERTICAL)   | TB     | TERMINAL BLOCK               |

- NOTES:
- About the outdoor side electric wiring refer to the outdoor unit electric wiring diagram for servicing.
  - Use copper conductors only. (For field wiring)
  - Symbols below indicate.  
 : Terminal block  
 : Connector

## MSZ-FE09NA - 8 MSZ-FE12NA - 8

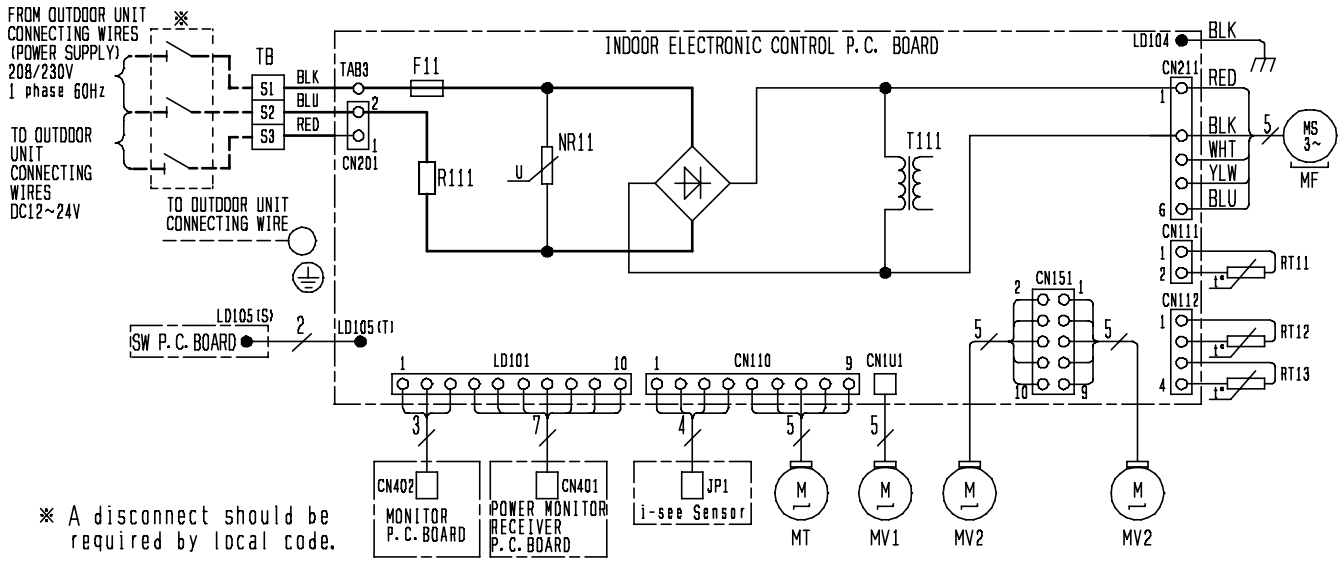

\* A disconnect should be required by local code.

- NOTES:
- About the outdoor side electric wiring refer to the outdoor unit electric wiring diagram for servicing.
  - Use copper conductors only. (For field wiring)
  - Symbols below indicate.  
 : Terminal block  
 : Connector

| SYMBOL | NAME                    | SYMBOL | NAME                         |
|--------|-------------------------|--------|------------------------------|
| F11    | FUSE (T3. 15AL250V)     | R111   | RESISTOR                     |
| MF     | FAN MOTOR               | RT11   | ROOM TEMP. THERMISTOR        |
| MT     | i-see Sensor MOTOR      | RT12   | COIL TEMP. THERMISTOR (MAIN) |
| MV1    | VANE MOTOR (HORIZONTAL) | RT13   | COIL TEMP. THERMISTOR (SUB)  |
| MV2    | VANE MOTOR (VERTICAL)   | T111   | TRANSFORMER                  |
| NR11   | VARISTOR                | TB     | TERMINAL BLOCK               |

## MSZ-FE18NA

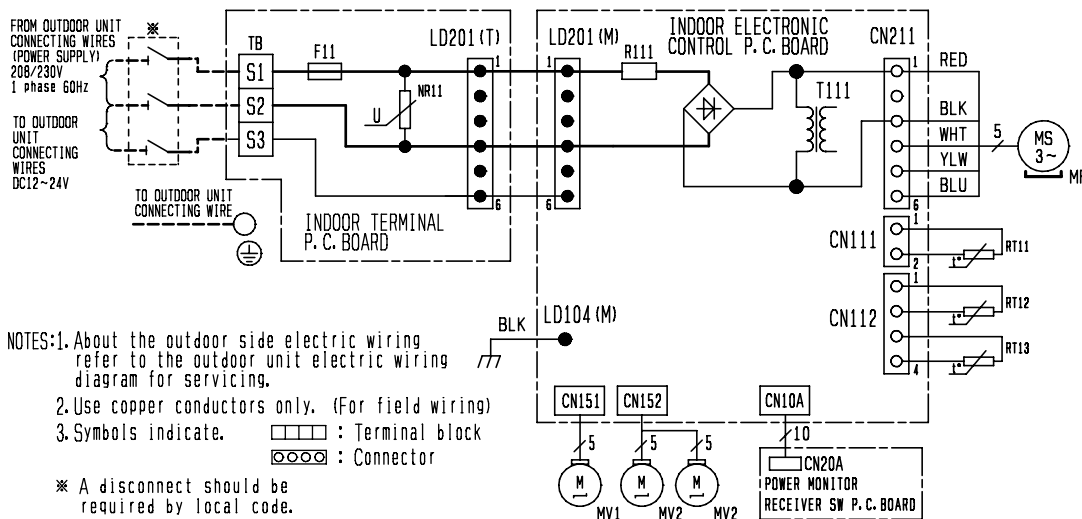

| SYMBOL | NAME                         |
|--------|------------------------------|
| F11    | FUSE (T3. 15AL250V)          |
| MF     | FAN MOTOR                    |
| MV1    | VANE MOTOR (HORIZONTAL)      |
| MV2    | VANE MOTOR (VERTICAL)        |
| NR11   | VARISTOR                     |
| R111   | RESISTOR                     |
| RT11   | ROOM TEMP. THERMISTOR        |
| RT12   | COIL TEMP. THERMISTOR (MAIN) |
| RT13   | COIL TEMP. THERMISTOR (SUB)  |
| T111   | TRANSFORMER                  |
| TB     | TERMINAL BLOCK               |



# 6

# REFRIGERANT SYSTEM DIAGRAM

## MSZ-FE09NA MSZ-FE12NA

Unit: inch

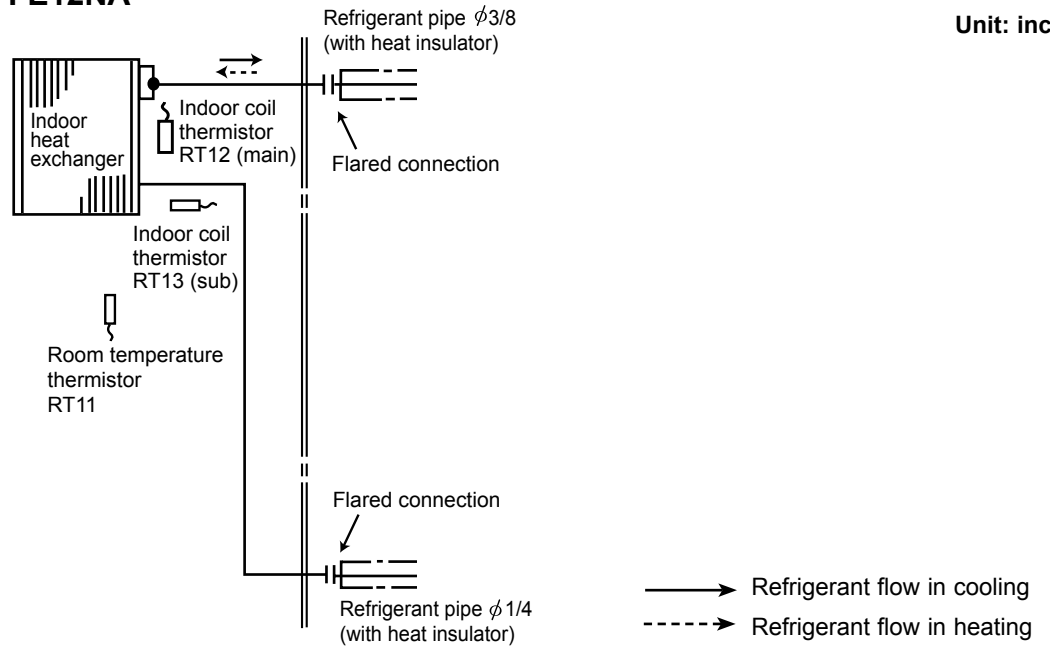

## MSZ-FE18NA

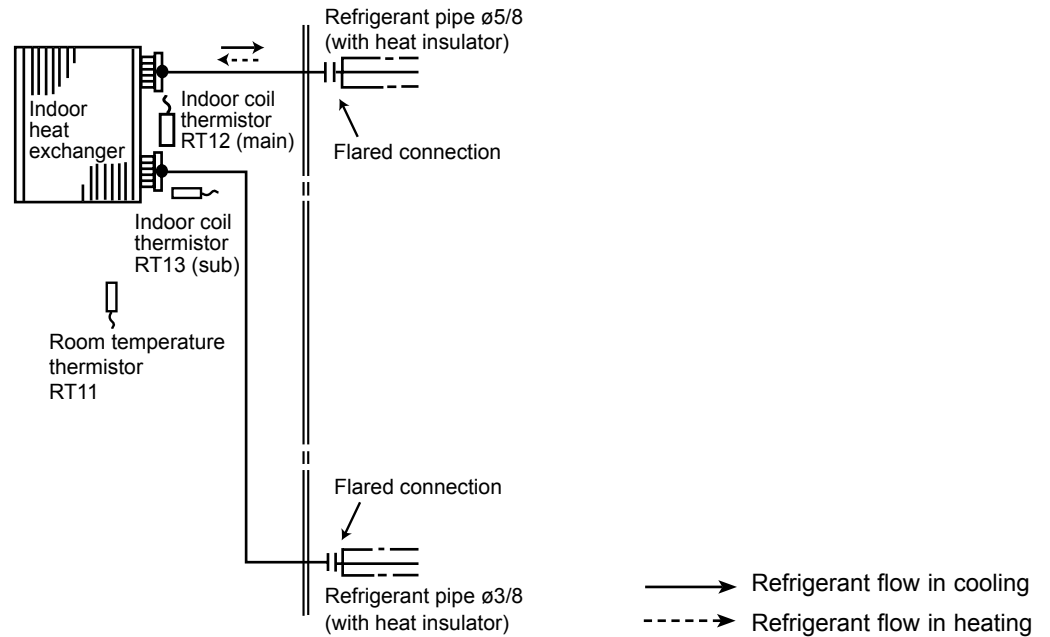

**MSZ-FE09NA MSZ-FE12NA MSZ-FE18NA****7-1. TIMER SHORT MODE**

For service, set time can be shortened by short circuit of JPG and JPS the indoor electronic control P.C. board.  
The time will be shortened as follows. (Refer to 9-7.)

Set time: 1-minute → 1-second

Set time: 3-minute → 3-second (It takes 3 minutes for the compressor to start operation. However, the starting time is shortened by short circuit of JPG and JPS.)

**7-2. P.C. BOARD MODIFICATION FOR INDIVIDUAL OPERATION**

A maximum of 4 indoor units with wireless remote controllers can be used in a room.

In this case, to operate each indoor unit individually by each remote controller, P.C. boards of remote controller must be modified according to the number of the indoor unit.

**How to modify the remote controller P.C. board**

Remove batteries before modification.

The board has a print as shown below:

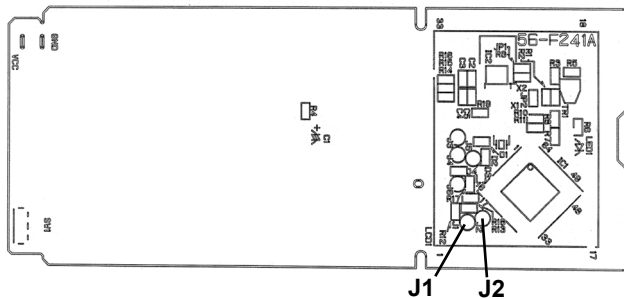

**NOTE:** For modification, take out the batteries and press the OPERATE/STOP (ON/OFF) button twice or 3 times at first.

After finish modification, put back the batteries then press the RESET button.

The P.C. board has the print “J1” and “J2”. Solder “J1” and “J2” according to the number of indoor unit as shown in Table 1. After modification, press the RESET button.

**Table 1**

|            | 1 unit operation | 2 units operation | 3 units operation | 4 units operation     |
|------------|------------------|-------------------|-------------------|-----------------------|
| No. 1 unit | No modification  | Same as at left   | Same as at left   | Same as at left       |
| No. 2 unit | —                | Solder J1         | Same as at left   | Same as at left       |
| No. 3 unit | —                | —                 | Solder J2         | Same as at left       |
| No. 4 unit | —                | —                 | —                 | Solder both J1 and J2 |

**How to set the remote controller exclusively for particular indoor unit**

After you turn the breaker ON, the first remote controller that sends the signal to the indoor unit will be regarded as the remote controller for the indoor unit.

The indoor unit will only accept the signal from the remote controller that has been assigned to the indoor unit once they are set.

The setting will be cancelled if the breaker has turned OFF, or the power supply has shut down.

Please conduct the above setting once again after the power has restored.

### 7-3. AUTO RESTART FUNCTION

When the indoor unit is controlled with the remote controller, the operation mode, the set temperature, and the fan speed are memorized by the indoor electronic control P.C. board. "AUTO RESTART FUNCTION" automatically starts operation in the same mode just before the shutoff of the main power.

#### Operation

- ① If the main power has been cut, the operation settings remain.
- ② After the power is restored, the unit restarts automatically according to the memory.  
(However, it takes at least 3 minutes for the compressor to start running.)

#### How to release "AUTO RESTART FUNCTION"

- ① Turn off the main power of the unit.
- ② Solder the Jumper wire JR07 on the indoor electronic control P.C. board. (Refer to 9-7.)

#### MSZ-FE09NA MSZ-FE12NA

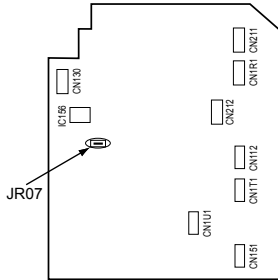

#### MSZ-FE18NA

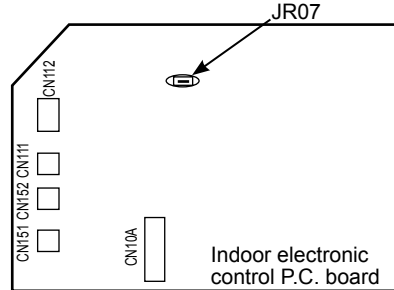

#### NOTE:

- The operation settings are memorized when 10 seconds have passed after the indoor unit was operated with the remote controller.
- If main power is turned OFF or a power failure occurs while AUTO START/STOP timer is active, the timer setting is cancelled.
- If the unit has been off with the remote controller before power failure, the auto restart function does not work as the power button of the remote controller is OFF.
- To prevent breaker OFF due to the rush of starting current, systematize other home appliance not to turn ON at the same time.
- When some air conditioners are connected to the same supply system, if they are operated before power failure, the starting current of all the compressors may flow simultaneously at restart. Therefore, the special counter-measures are required to prevent the main voltage-drop or the rush of the starting current by adding to the system that allows the units to start one by one.

### 7-4. REMOTE CONTROLLER (MSZ-FE09NA MSZ-FE12NA)

Be sure to set the slide switch inside the remote controller to an appropriate position according to the installed position of the indoor unit. If the switch is not set correctly, the air conditioner may not function properly.

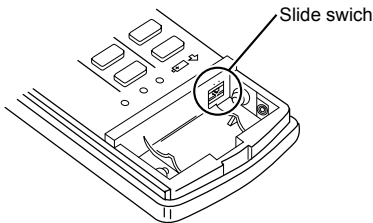

| Area                             | Left | Center | Right |
|----------------------------------|------|--------|-------|
| Position of the slide switch     |      |        |       |
| Display on the remote controller |      |        |       |

Where is the indoor unit installed in your room?

Installed at left, if the distance is not more than 19-3/4 inch (50 cm).

Installed at right, if the distance is not more than 19-3/4 inch (50 cm).

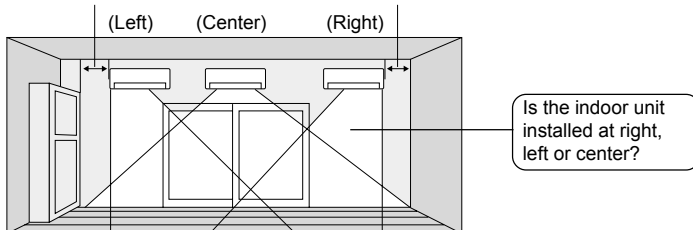

**NOTE:** If the indoor unit is installed more than 19-3/4 inch (50 cm) away from the side walls, cabinets or other nearby objects, set the slide switch to the "center" position.

**MSZ-FE09NA MSZ-FE12NA MSZ-FE18NA**

**WIRELESS REMOTE CONTROLLER**

MSZ-FE09NA MSZ-FE12NA

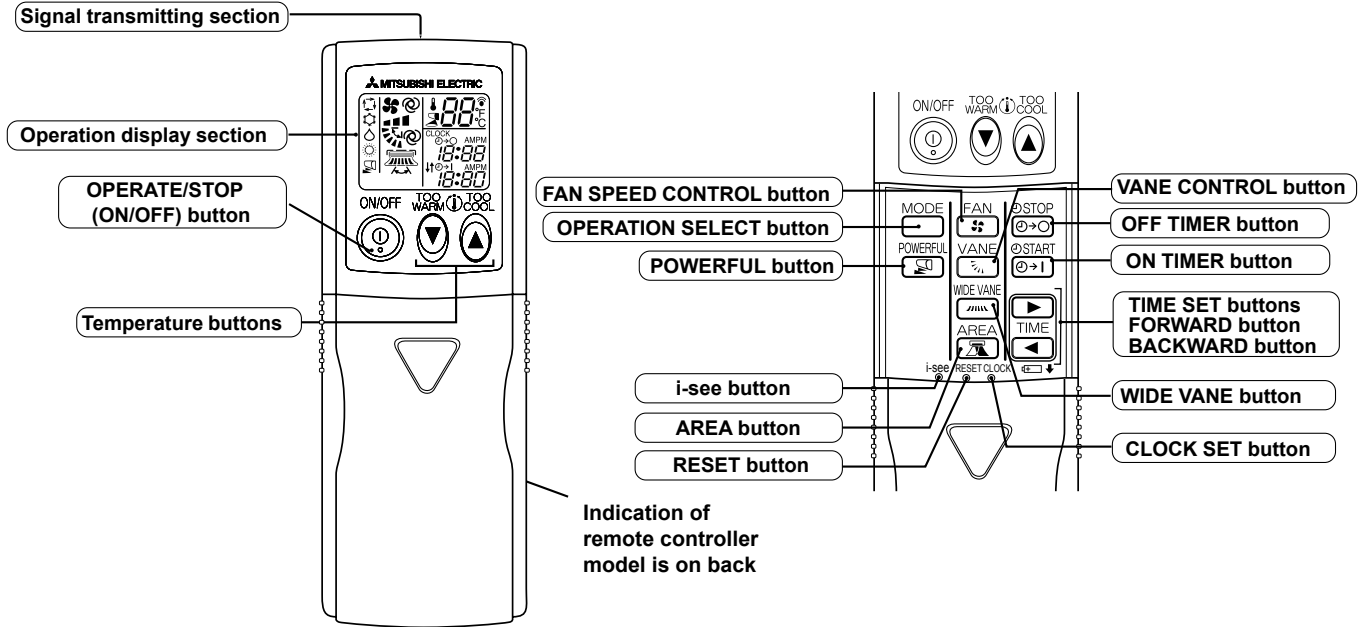

**MSZ-FE18NA**

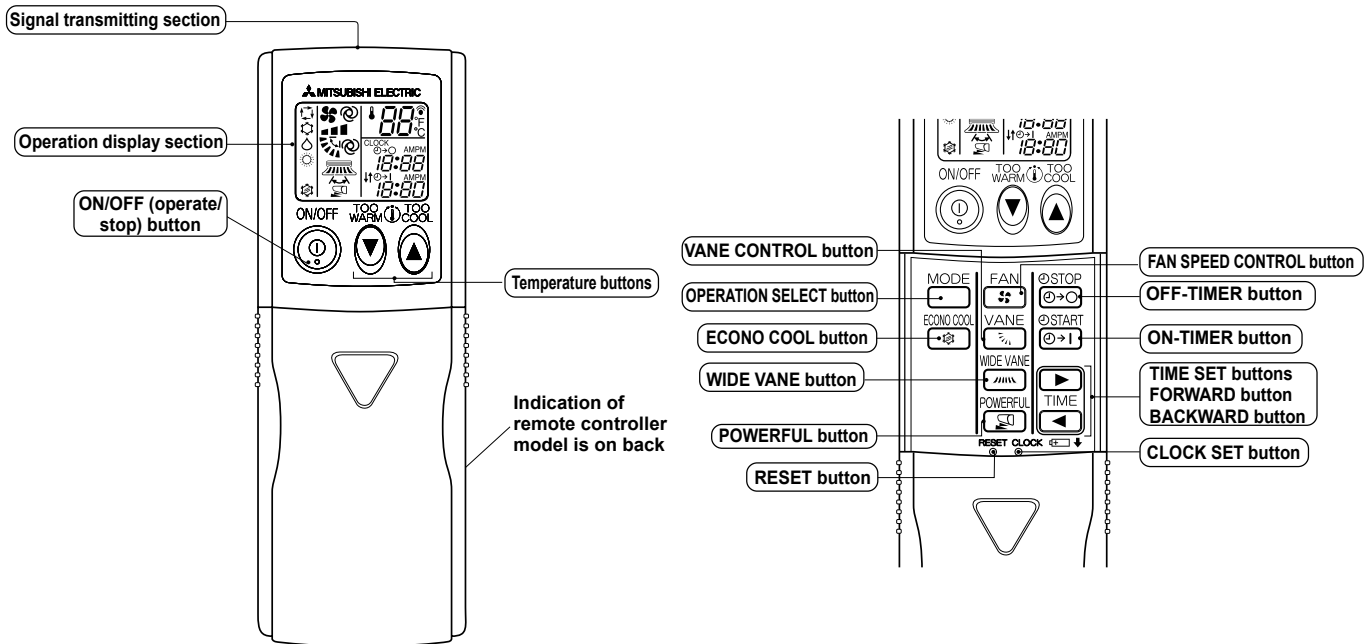

**NOTE:** Last setting will be stored after the unit is turned OFF with the remote controller. Indoor unit receives the signal of the remote controller with beeps.

## INDOOR UNIT DISPLAY SECTION

### Operation indicator lamp

#### MSZ-FE09NA MSZ-FE12NA







The lamps at the center of the indoor unit indicates the operation state.



| Lamp  | Operation state   |
|-------|---|
| AREA  | Refer to 8-7.   |
| POWER | Lamp lights during operation.<br>Lamp blinks in abnormal condition. |

#### MSZ-FE18NA

The operation indicator at the right side of the indoor unit indicates the operation state.

•The following indication applies regardless of shape of the indication.

| Indication  | Operation state   | Room temperature                                  |
|---|---|---|
| <br>    | The unit is operating to reach the set temperature      | About 4°F (2°C) or more away from set temperature |
| <br>    | The room temperature is approaching the set temperature | About 2 to 4°F (1 to 2°C) from set temperature    |
| <br> | Standby mode<br>(Only during multi system operation)    | —   |

-  Lighted
-  Blinking
-  Not lighted

### 8-1. COOL ( ❄ ) OPERATION

(1) Press OPERATE/STOP (ON/OFF) button.

POWER lamp (**MSZ-FE09/12NA**)/OPERATION INDICATOR lamp (**MSZ-FE18NA**) of the indoor unit turns on with a beep tone.

(2) Select COOL mode with OPERATION SELECT button.

(3) Press TEMPERATURE buttons (TOO WARM or TOO COOL button) to select the desired temperature.

The setting range is 61 ~ 88°F (16 ~ 31°C).

#### 1. Coil frost prevention

The compressor operational frequency is controlled by the temperature of the indoor heat exchanger to prevent the coil from frosting.

When the temperature of indoor heat exchanger becomes too low, the coil frost prevention mode works.

The indoor fan operates at the set speed and the compressor stops. This mode continues until the temperature of indoor heat exchanger rises.

#### 2. Low outside temperature operation

When the outside temperature is lower, low outside temperature operation starts, and the outdoor fan slows or stops.

### 8-2. DRY ( ☹ ) OPERATION

(1) Press OPERATE/STOP (ON/OFF) button.

POWER lamp (**MSZ-FE09/12NA**)/OPERATION INDICATOR lamp (**MSZ-FE18NA**) of the indoor unit turns on with a beep tone.

(2) Select DRY mode with OPERATION SELECT button.

(3) The set temperature is determined from the initial room temperature.

#### 1. Coil frost prevention

Coil frost prevention is as same as COOL mode. (8-1.1.)

#### 2. Low outside temperature operation

Low outside temperature operation is as same as COOL mode. (8-1.2.)

### 8-3. HEAT (☀) OPERATION

- (1) Press OPERATE/STOP (ON/OFF) button.  
POWER lamp (MSZ-FE09/12NA)/OPERATION INDICATOR lamp (MSZ-FE18NA) of the indoor unit turns on with a beep tone.
- (2) Select HEAT mode with OPERATION SELECT button.
- (3) Press TEMPERATURE buttons (TOO WARM or TOO COOL button) to select the desired temperature.  
The setting range is 61 ~ 88°F (16 ~ 31°C).

#### 1. Cold air prevention control

When the compressor is not operating or is starting, and the temperature of indoor heat exchanger and/or the room temperature is low or when defrosting is being done, the indoor fan will stop or rotate in Very Low speed.

#### 2. High pressure protection

The compressor operational frequency is controlled by the temperature of the indoor heat exchanger to prevent the condensing pressure from increasing excessively.

When the temperature of indoor heat exchanger becomes too high, the high pressure protection works.

The indoor fan operates following the cold air prevention control. This mode continues until the temperature of indoor heat exchanger falls.

#### 3. Defrosting

Defrosting starts when the temperature of outdoor heat exchanger becomes too low.

The compressor stops once, the indoor/outdoor fans stop, the 4-way valve reverses and the compressor re-starts.

This mode continues until the temperature of outdoor heat exchanger rises or the fixed time passes.

### 8-4. AUTO CHANGE OVER ... AUTO MODE OPERATION

Once desired temperature is set, unit operation is switched automatically between COOL and HEAT operation.

#### Mode selection

##### (1) Initial mode

When unit starts the operation with AUTO operation from off:

- If the room temperature is higher than the set temperature, operation starts in COOL mode.
- If the room temperature is equal to or lower than the set temperature, operation starts in HEAT mode.

##### (2) Mode change

COOL mode changes to HEAT mode when about 15 minutes have passed with the room temperature 2°F (1°C) below the set temperature.

HEAT mode changes to COOL mode when about 15 minutes have passed with the room temperature 2°F (1°C) above the set temperature.

#### NOTE1

If 2 or more indoor units are operating in multi system, there might be a case that the indoor unit, which is operating in □ (AUTO), cannot change over to the other operating mode (COOL ↔ HEAT) and becomes a state of standby.

Refer to **NOTE 2 "FOR MULTI SYSTEM AIR CONDITIONER"**.

#### NOTE 2

#### FOR MULTI SYSTEM AIR CONDITIONER

##### OUTDOOR UNIT: MXZ series

Multi system air conditioner can connect two or more indoor units with one outdoor unit.

- When you try to operate 2 or more indoor units with one outdoor unit simultaneously, one for the cooling and the others for heating, the operation mode of the indoor unit that operates earlier is selected. Other indoor units cannot operate, and operation indicator lamp flashes as shown in the figure below. In this case, please set all the indoor units to the same operation mode

#### OPERATION INDICATOR

##### MSZ-FE09/12NA



##### POWER



##### MSZ-FE18NA



Lighted

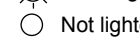

Blinking

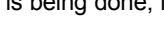

Not lighted

- When indoor unit starts the operation while the defrosting of outdoor unit is being done, it takes a few minutes (max. 10 minutes) to blow out the warm air.
- In the heating operation, though indoor unit that does not operate may get warm or the sound of refrigerant flowing may be heard, they are not malfunction. The reason is that the refrigerant continuously flows into it.

## 8-5. AUTO VANE OPERATION

### 1. Horizontal vane

(1) Vane motor drive

These models are equipped with a stepping motor for the horizontal vane. The rotating direction, speed, and angle of the motor are controlled by pulse signals (approx. 12 V) transmitted from indoor microprocessor.

(2) The horizontal vane angle and mode change as follows by pressing VANE CONTROL button.

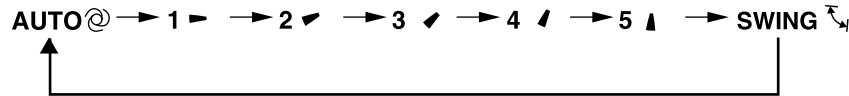

(3) Positioning

To confirm the standard position, the vane moves until it touches the vane stopper. Then the vane is set to the selected angle.

Confirming of standard position is performed in the following cases:

- (a) When the operation starts or finishes (including timer operation).
- (b) When the test run operation starts.
- (c) When standby mode (only during multi system operation) starts or finishes.

(4) VANE AUTO ( @ ) mode

The microprocessor automatically determines the vane angle to make the optimum room temperature distribution.

#### MSZ-FE09NA MSZ-FE12NA

In COOL and DRY operation  
Vane angle is fixed to Horizontal position.

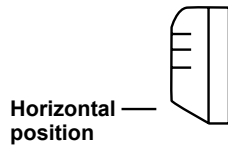

Horizontal position

In HEAT operation  
Vane angle is fixed to Angle 4.

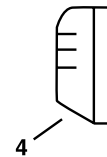

4

#### MSZ-FE18NA

In COOL and DRY operation  
Vane angle is fixed to Horizontal position

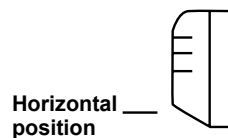

Horizontal position

In HEAT operation  
Vane angle is fixed to Angle 5.



5

(5) STOP (operation OFF) and ON TIMER standby

In the following cases, the horizontal vane returns to the closed position.

- (a) When OPERATE/STOP (ON/OFF) button is pressed (POWER OFF).
- (b) When the operation is stopped by the emergency operation.
- (c) When ON TIMER is ON standby.

(6) Dew prevention

#### MSZ-FE09NA MSZ-FE12NA

During COOL or DRY operation with the vane angle at Angle 3 ~ 5 when the compressor cumulative operation time exceeds 1 hour or 30 minutes, the vane angle automatically changes to Angle 2 for dew prevention.

#### MSZ-FE18NA

During COOL or DRY operation with the vane angle at Angle 4 ~ 5 when the compressor cumulative operation time exceeds 1 hour, the vane angle automatically changes to Angle 1 for dew prevention.

(7) SWING ( ㄣ ) mode

By selecting SWING mode with VANE CONTROL button, the horizontal vane swings vertically.

(8) Cold air prevention in HEAT operation

The horizontal vane position is set to Upward.

**NOTE:** When 2 or more indoor units are operated with multi outdoor unit, even if any indoor unit turns thermostat off, this control does not work in the indoor unit.

(9) ECONO COOL (🌀) operation (ECONOMical operation) (MSZ-FE18NA)

When ECONO COOL button is pressed in COOL mode, set temperature is automatically set 2°C higher.

Also the horizontal vane swings in various cycle.

SWING operation makes you feel cooler than set temperature. So, even though the set temperature is higher, the air conditioner can keep comfort. As a result, energy can be saved.

To cancel this operation, select a different mode or press one of the following buttons in ECONO COOL operation: ECONO COOL, VANE CONTROL or POWERFUL button.

(10) POWERFUL (🔥) operation

The air conditioner automatically adjusts the fan speed and the set temperature, and operates the POWERFUL mode.

The POWERFUL mode is automatically released 15 minutes after operation starts, and the operation mode returns to the mode prior to POWERFUL operation. To manually cancel this operation, select a different mode or press

POWERFUL /or ECONO COOL(MSZ-FE18NA) button.

2. Vertical vane

(1) Vane motor drive

These models are equipped with a stepping motor for the vertical vane. The rotating direction, speed, and angle of the motor are controlled by pulse signals (approx. 12 V) transmitted from microprocessor.

(2) The vertical vane angle and mode change as follows by pressing WIDE VANE button.

MSZ-FE09NA MSZ-FE12NA

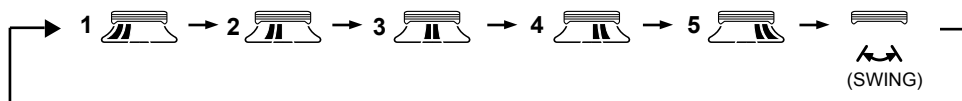

MSZ-FE18NA

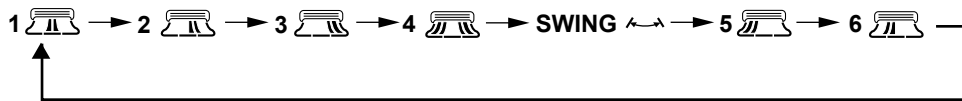

(3) Positioning

To confirm the standard position, the vane moves until it touches the vane stopper. Then the vane is set to the selected angle.

Confirming of standard position is performed in the following cases:

- (a) When OPERATE/STOP (ON/OFF) button is pressed (POWER ON).
- (b) When SWING is started.
- (c) When the power supply turns ON.

(4) SWING MODE (↔)

By selecting SWING mode with WIDE VANE button, the vertical vane swings horizontally.

The remote controller displays “↔”. Swing mode is cancelled when WIDE MODE button is pressed once again.

(5) WIDE MODE (🌀) (MSZ-FE18NA)

By selecting WIDE mode with WIDE VANE button, indoor fan speed becomes faster than setting fan speed on the remote controller (※). The remote controller displays “🌀”.

**NOTE:** ※ Indoor fan speed becomes faster than setting fan speed on the remote controller even when 🌀 or 🌀 is selected.



## 8-6. i-see CONTROL OPERATION (MSZ-FE09NA MSZ-FE12NA)

The sensors constantly measure the room and floor/wall temperatures to automatically adjust to the set temperature by estimating the temperature actually perceived by a person inside the room ("sensory temperature").

### Advantages

- The air inside the room is conditioned quickly to a comfortable condition.
  - The room will not become too cold or hot even when the air conditioner is kept on for a long period.
  - The air conditioner will not overcool or overheat, which means you can save on electricity.
- i-see control operation is activated when i-see button is pressed with a thin stick in manual COOL or manual HEAT mode.

**NOTE:** i-see control operation is activated when the remote controller is first used following replacement of the batteries or resetting of the remote controller.

i-see control operation is cancelled when i-see button is pressed with a thin stick once again.

**NOTE:** If the conditioner is turned OFF without cancelling i-see control operation, i-see control operation is activated the next time the air conditioner is turned ON.

### i-see Sensor

i-see Sensor, which is installed on the upper of the air outlet of the indoor unit, is moved with the stepping motor and it detects the floor/wall temperature.

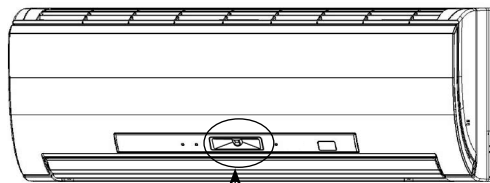

i-see Sensor is installed here.

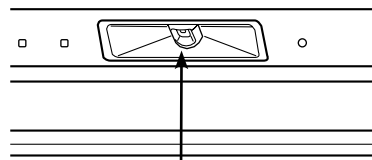

Enlarged view of i-see Sensor

### i-see Sensor

- When AREA setting is not activated, the sensing range of i-see Sensor differs depending on the installation location of the air conditioner.

| Installation position  | Installed at left | Installed at center | Installed at right |
|------------------------|-------------------|---------------------|--------------------|
| Image of sensing range |                   |                     |                    |
| Direction of sensor    | Right             | Center              | Left               |



Refer to "Remote controller in SERVICE FUNCTIONS".

- Install the front panel correctly after being removed for maintenance or service so that the floor/wall temperatures can be measured correctly.

## 8-7. AREA ( ) SETTING (MSZ-FE09NA MSZ-FE12NA)

- (1) Press OPERATE/STOP (ON/OFF) button to start the air conditioner.
- (2) Press i-see button. (**NOTE1**)
- (3) Press AREA button.

Each time the button is pressed, the area is changed in sequence:

 (AUTO) →  (LEFT) →  (RIGHT) → Cancel

i-see Sensor moves intermittently, measuring the floor and wall temperature.

- (4) AREA setting is cancelled when the "cancel" is selected by pressing AREA button, or when WIDE VANE button is pressed.

**NOTE1:** AREA setting is only available during i-see control operation.

**NOTE2:** If AREA setting is cancelled, the vertical vane returns to the previously set position before AREA setting.

**NOTE3:** The horizontal air flow direction (WIDE VANE button), including horizontal SWING, cannot be set during AREA setting

●Indoor unit installation location and air-conditioning area

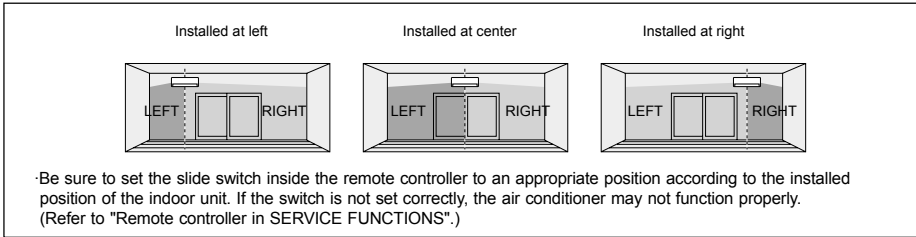

|  |   |  |  |
|--|---|--|--|
|  | To air-condition mainly the left area of the room | To air-condition the entire room<br>The horizontal air flow direction and indoor unit display are switched according to the room temperature (floor/wall). | To air-condition mainly the right area of the room |
| Remote controller button   | Press AREA button to select LEFT.                 | Press AREA button to select AUTO.  | Press AREA button to select RIGHT.                 |
| Remote controller display  |   |  |  |
| i-see Sensor operation   |   |  |  |
| Control range of horizontal air flow direction. The vertical air flow direction conforms to the setting on the remote controller. (The horizontal air flow direction is controlled in this range.) | Installed at center<br>                           |  |  |
|  | Installed at left<br>                             |  |  |
|  | Installed at right<br>                            |  |  |
| Indoor unit display  | AREA<br>L R<br>● ○                                | L R or L R or L R<br>● ○ or ● ● or ○ ●   | L R<br>○ ●   |

● Lighted  
○ Not lighted

●When AREA is set to AUTO

- The vertical vane is controlled to maintain uniform temperature in the whole room.
- The i-see Sensor moves in a range of 150 degrees detecting floor/wall temperature of 3 areas (left, right, center). Therefore, the detected temperatures may be different from the temperatures measured on commercial thermometers depending on the condition or temperature distribution on the floor and/or wall.

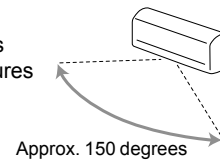

Ex.) In COOL mode

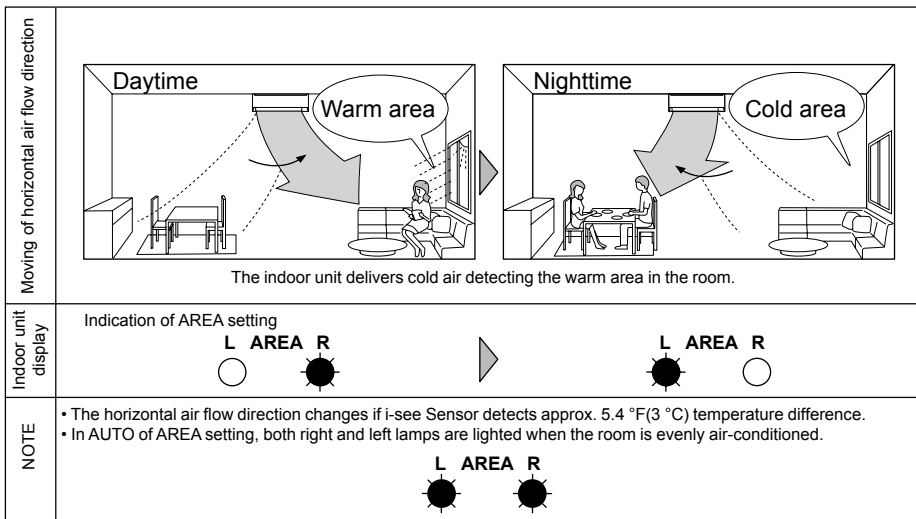

● Lighted  
○ Not lighted

## Operation and operating range

i-see sensor moves 30 degrees from the center in both right and left side.

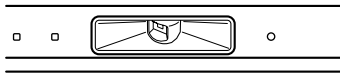

i-see Sensor turning to the left

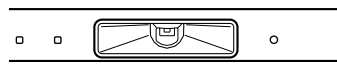

i-see Sensor turning to the center

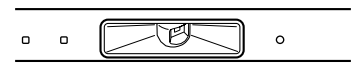

i-see Sensor turning to the right

i-see Sensor operates as follows in accordance with AREA setting made with the remote controller.

“AUTO” in AREA setting: first turning to the LEFT for adjusting the position then .....  
CENTER → RIGHT → CENTER → LEFT → CENTER .....  
(The sensor turns to the right, left and center.)

“RIGHT” in AREA setting: first turning to the LEFT for adjusting the position then .....  
CENTER → RIGHT → CENTER → RIGHT → CENTER .....  
(The sensor turns to the right and center.)

“LEFT” in AREA setting: first turning to the LEFT for adjusting the position then .....  
CENTER → LEFT → CENTER → LEFT → CENTER .....  
(The sensor turns to the left and center.)

The sensor finishes turning to one area to another for 3 seconds and it operates one area for 5 seconds.

## 8-8. TIMER OPERATION

### 1. How to set the time



(1) Check that the current time is set correctly.

**NOTE:** Timer operation will not work without setting the current time. Initially “0:00 AM” blinks at the current time display of TIME MONITOR, so set the current time correctly with CLOCK SET button.

#### How to set the current time

(a) Press the CLOCK set button.

(b) Press the TIME SET buttons (  and  ) to set the current time.

- Each time FORWARD button (  ) is pressed, the set time increases by 1 minute, and each time BACKWARD button (  ) is pressed, the set time decreases by 1 minute.
- Pressing those buttons longer, the set time increases/decreases by 10 minutes.



(c) Press the CLOCK set button.

(2) Press OPERATE/STOP (ON/OFF) button to start the air conditioner.

(3) Set the time of timer.



#### ON timer setting



(a) Press ON TIMER button (  ) during operation.

(b) Set the time of the timer using TIME SET buttons (  and  ). ※

#### OFF timer setting

(a) Press OFF TIMER button (  ) during operation.

(b) Set the time of the timer using TIME SET buttons (  and  ). ※

※ Each time FORWARD button (  ) is pressed, the set time increases by 10 minutes: each time BACKWARD button (  ) is pressed, the set time decreases by 10 minutes.

### 2. To release the timer

To release ON timer, press ON TIMER button (  ).

To release OFF timer, press OFF TIMER button (  ).

TIMER is cancelled and the display of set time disappears.

## PROGRAM TIMER

- OFF timer and ON timer can be used in combination. The timer of the set time that is reached first will operate first.
- “↓” and “↑” display shows the order of OFF timer and ON timer operation.

(Example 1) The current time is 8:00 PM.

The unit turns off at 11:00 PM, and on at 6:00 AM.

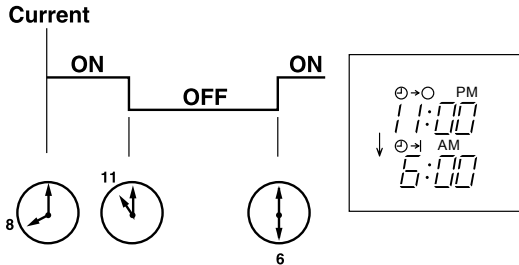

(Example 2) The current time is 11:00 AM.

The unit turns on at 5:00 PM, and off at 9:00 PM.

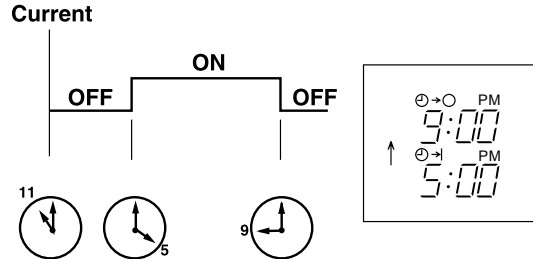

**NOTE:** If the main power is turned OFF or a power failure occurs while ON/OFF timer is active, the timer setting is cancelled. As these models are equipped with an auto restart function, the air conditioner starts operating with timer cancelled when power is restored.

## 8-9. EMERGENCY/TEST OPERATION

In case of test run operation or emergency operation, use EMERGENCY OPERATION switch on the right side of the indoor unit. Emergency operation is available when the remote controller is missing, has failed or the batteries of the remote controller run down. The unit will start and AREA lamp (MSZ-FE09/12NA)/OPERATION INDICATOR lamp (MSZ-FE18NA) will light.

The first 30 minutes of operation is the test run operation. This operation is for servicing.

The indoor fan runs at High speed and temperature control does not work.

After 30 minutes of test run operation, the system shifts to EMERGENCY COOL/HEAT MODE with a set temperature of 75°F (24°C). The fan speed shifts to Med.

All protective operations such as the coil frost prevention works even in the test run or the emergency operation.

In the test run or emergency operation, the horizontal vane operates in VANE AUTO (⊙) mode.

Emergency operation continues until EMERGENCY OPERATION switch is pressed once or twice or the unit receives any signal from the remote controller. In case of latter, normal operation will start.

**NOTE:** Do not press EMERGENCY OPERATION switch during normal operation.

### MSZ-FE09NA MSZ-FE12NA

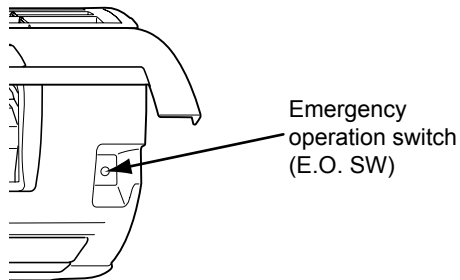

### MSZ-FE18NA

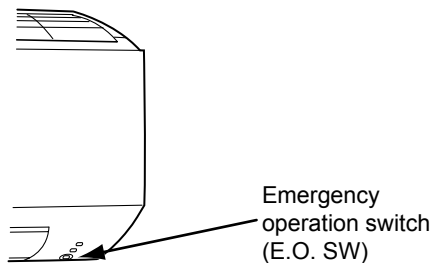

| Operation mode                 | COOL        | HEAT        |
|--------------------------------|-------------|-------------|
| Set temperature                | 75°F (24°C) | 75°F (24°C) |
| Fan speed                      | Med.        | Med.        |
| Horizontal vane                | Auto        | Auto        |
| Vertical vane<br>MSZ-FE09/12NA | Straight    | Straight    |

The operation mode is indicated by the AREA lamp as following

### MSZ-FE09NA MSZ-FE12NA

| AREA lamp      | L | AREA | R |
|----------------|---|------|---|
| EMERGENCY COOL | ● | ↓    | ○ |
| EMERGENCY HEAT | ○ | ↓    | ● |
| STOP           | ○ |      | ○ |

● Lighted  
○ Not lighted

### MSZ-FE18NA

|                |   |   |
|----------------|---|---|
| EMERGENCY COOL | ● | ← |
| EMERGENCY HEAT | ○ | ← |
| STOP           | ○ | ← |

● Lighted  
○ Not lighted

**NOTE:**

This is the indication of EMERGENCY OPERATION mode.

AREA setting is not available during EMERGENCY OPERATION.

### 8-10. 3-MINUTE TIME DELAY OPERATION

When the system turns OFF, compressor will not restart for 3 minutes as 3-minute time delay function operates to protect compressor from overload.

### 8-11. Changing temperature indication (°F/°C)

- The preset unit is °F.
- °F → °C: Press RESET button while the temperature buttons are pressed.
- °C → °F: Press RESET button or remove the batteries .

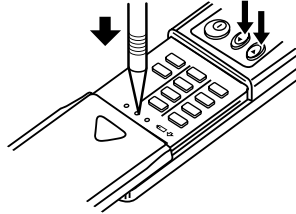

Press RESET button gently using a thin instrument.

**MSZ-FE09NA MSZ-FE12NA MSZ-FE18NA****9-1. CAUTIONS ON TROUBLESHOOTING****1. Before troubleshooting, check the following**

- 1) Check the power supply voltage.
- 2) Check the indoor/outdoor connecting wire for miswiring.

**2. Take care of the following during servicing**

- 1) Before servicing the air conditioner, be sure to turn off the unit first with the remote controller, and then after confirming the horizontal vane is closed, turn off the breaker and/or disconnect the power plug.
- 2) Be sure to turn OFF the power supply before removing the front panel, the cabinet, the top panel, and the P.C. board.
- 3) When removing the P.C. board, hold the edge of the board with care NOT to apply stress on the components.
- 4) When connecting or disconnecting the connectors, hold the housing of the connector. DO NOT pull the lead wires.

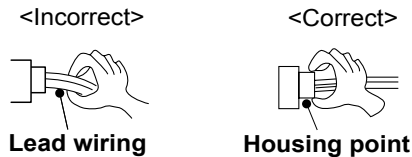
**3. Troubleshooting procedure**

- 1) First, check if the OPERATION INDICATOR lamp on the indoor unit is flashing on and off to indicate an abnormality. To make sure, check how many times the OPERATION INDICATOR lamp is flashing on and off before starting service work.
- 2) Before servicing, check that the connector and terminal are connected properly.
- 3) When the P.C. board seems to be defective, check the copper foil pattern for disconnection and the components for bursting and discoloration.
- 4) When troubleshooting, refer to 9-2, 9-3 and 9-4.

**4. How to replace batteries**

Weak batteries may cause the remote controller malfunction.

In this case, replace the batteries to operate the remote controller normally.

- ① Remove the front lid and insert batteries. Then reattach the front lid.

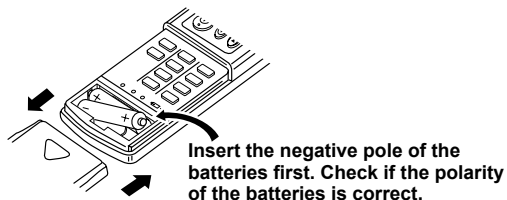

- ② Press RESET button with a thin instrument, and then use the remote controller.

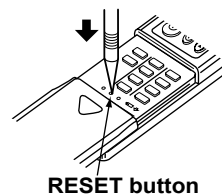

- NOTE:**
1. If RESET button is not pressed, the remote controller may not operate correctly.
  2. This remote controller has a circuit to automatically reset the microcomputer when batteries are replaced. This function is equipped to prevent the microcomputer from malfunctioning due to the voltage drop caused by the battery replacement.
  3. Do not use the leaking batteries.

## 9-2. FAILURE MODE RECALL FUNCTION

Outline of the function

This air conditioner can memorize the abnormal condition which has occurred once.

Even though LED indication listed on the troubleshooting check table (9-4.) disappears, the memorized failure details can be recalled.

This mode is very useful when the unit needs to be repaired for the abnormality which does not recur.

### 1. Flow chart of failure mode recall function for the indoor/outdoor unit **MSZ-FE09NA** **MSZ-FE12NA** **MSZ-FE18NA**

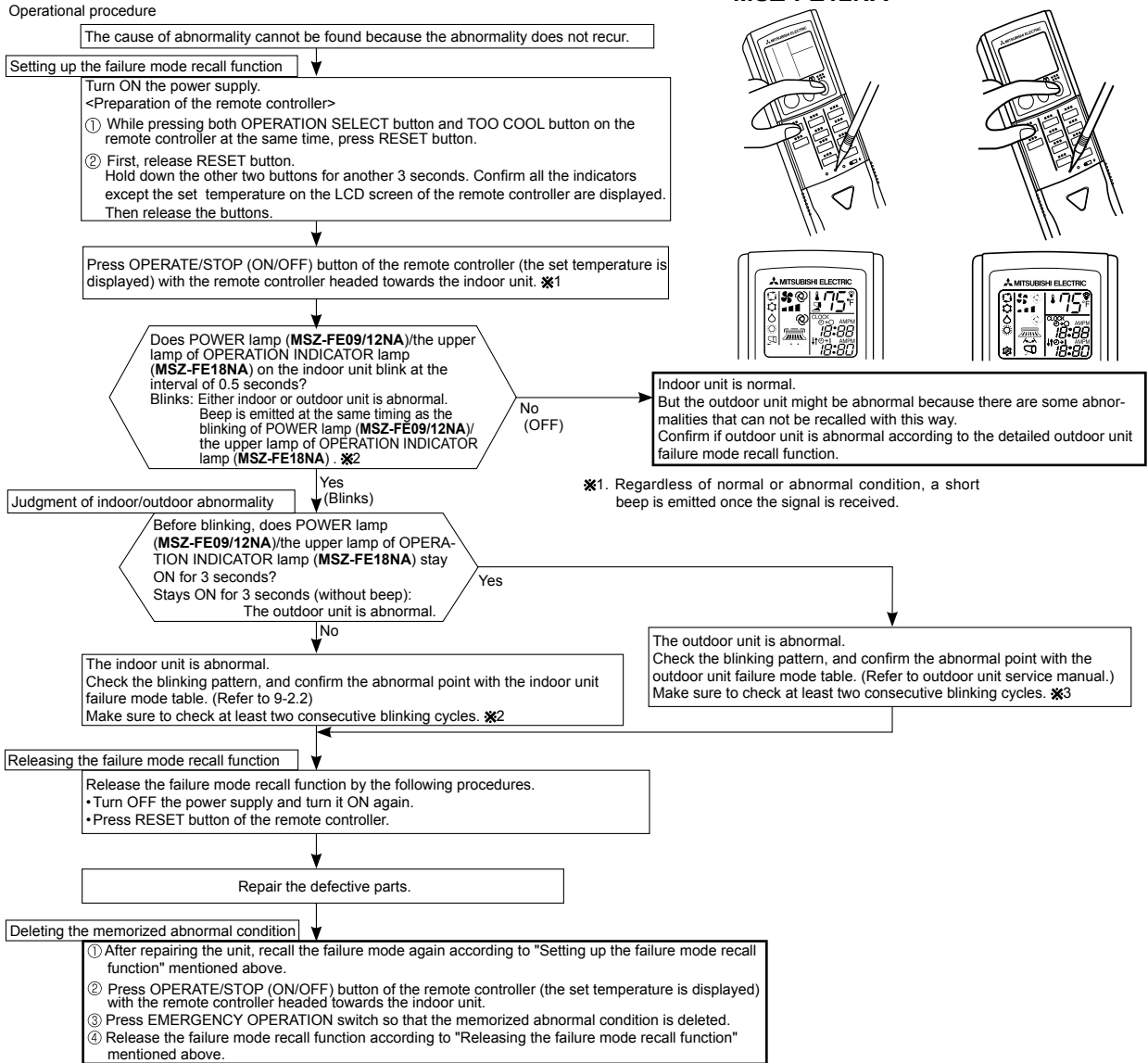

**NOTE:** 1. Make sure to release the failure mode recall function once it is set up, otherwise the unit cannot operate properly.  
2. If the abnormal condition is not deleted from the memory, the last abnormal condition is kept memorized.

\*2. Blinking pattern when the indoor unit is abnormal:

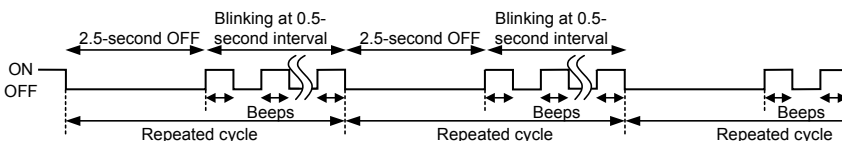

\*3. Blinking pattern when the outdoor unit is abnormal:

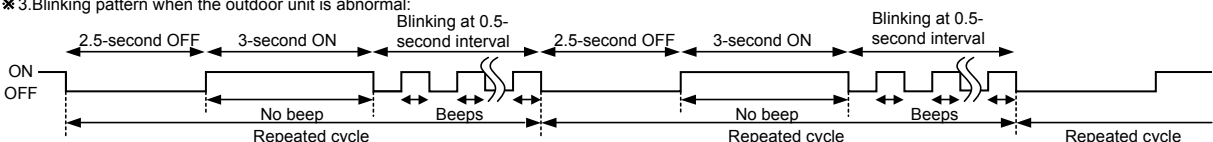



## 2. Indoor unit failure mode table

| POWER lamp<br>Upper lamp         | Abnormal point<br>(Failure mode) | Condition  | Remedy  |
|----------------------------------|----------------------------------|--|---|
| Not lighted                      | Normal                           | —  | —   |
| 1-time flash every<br>0.5-second | Room temperature<br>thermistor   | The room temperature thermistor short or open circuit is detected every 8 seconds during operation.            | Refer to the characteristics of the room temperature thermistor (9-7.).                                 |
| 2-time flash<br>2.5-second OFF   | Indoor coil thermistor           | The indoor coil thermistor short or open circuit is detected every 8 seconds during operation.                 | Refer to the characteristics of the main indoor coil thermistor, the sub indoor coil thermistor (9-7.). |
| 3-time flash<br>2.5-second OFF   | Serial signal                    | The serial signal from outdoor unit is not received for a maximum of 6 minutes.                                | Refer to 9-6.Ⓓ "How to check miswiring and serial signal error".  |
| 11-time flash<br>2.5-second OFF  | Indoor fan motor                 | The rotational frequency feedback signal is not emitted for 12 seconds after the indoor fan motor is operated. | Refer to 9-6.Ⓐ "Check of indoor fan motor".   |
| 12-time flash<br>2.5-second OFF  | Indoor control<br>system         | It cannot properly read data in the nonvolatile memory of the indoor electronic control P.C. board.            | Replace the indoor electronic control P.C. board.   |

**NOTE:** Blinking patterns of this mode differ from the ones of TROUBLESHOOTING CHECK TABLE (9-4.).

POWER lamp: **MSZ-FE09/12NA**

Upper lamp: **MSZ-FE18NA**



### 9-3. INSTRUCTION OF TROUBLESHOOTING

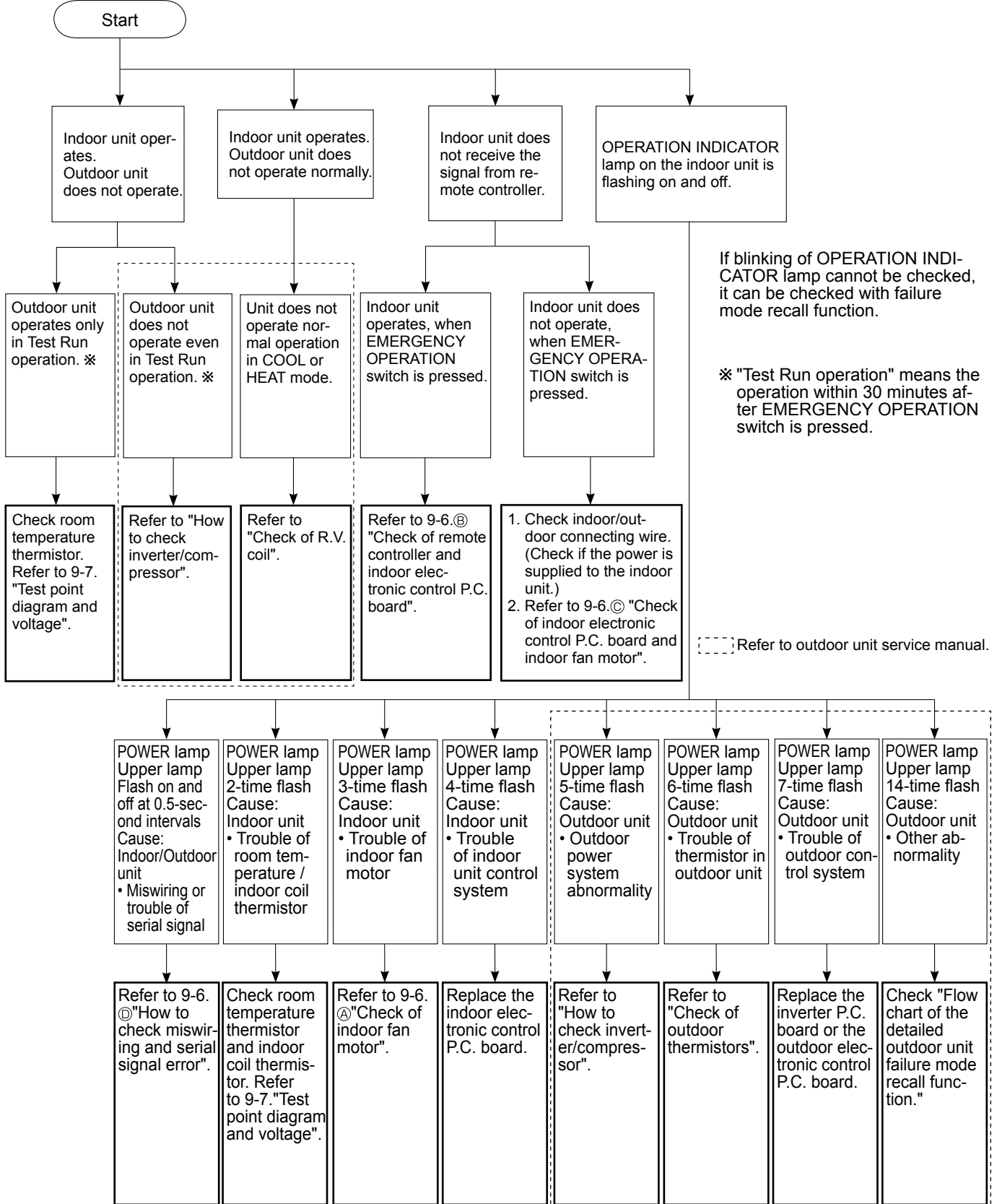

POWER lamp: **MSZ-FE09/12NA**  
Upper lamp: **MSZ-FE18NA**

## 9-4. TROUBLESHOOTING CHECK TABLE

Before taking measures, make sure that the symptom reappears for accurate troubleshooting.

When the indoor unit has started operation and the following detection method has detected an abnormality (the first detection after the power ON), the indoor electronic control P.C. board turns OFF the indoor fan motor with OPERATION INDICATOR lamp flashing.

**OPERATION INDICATOR**  
MSZ-FE09NA MSZ-FE12NA

MSZ-FE18NA

L AREA R

POWER



Lighted

Blinking

Not lighted



| No. | Abnormal point  | Operation indicator lamp  | Symptom                                      | Condition   | Remedy  |
|-----|---|---|--|---|---|
| 1   | Miswiring or serial signal                            | POWER lamp/Upper lamp flashes.<br>0.5-second ON<br>●●●●●●●●<br>0.5-second OFF             | Indoor unit and outdoor unit do not operate. | The serial signal from the outdoor unit is not received for 6 minutes.  | • Refer to 9-6. ㉔ "How to check miswiring and serial signal error".   |
| 2   | Indoor coil thermistor<br>Room temperature thermistor | POWER lamp/Upper lamp flashes.<br>2-time flash<br>●●○○○○○○●●●○○○<br>2.5-second OFF        |  | The indoor coil or the room temperature thermistor is short or open circuit.  | • Refer to the characteristics of indoor coil thermistor, and the room temperature thermistor (9-7).                            |
| 3   | Indoor fan motor                                      | POWER lamp/Upper lamp flashes.<br>3-time flash<br>●●●○○○○○○●●●●●○○○<br>2.5-second OFF     |  | The rotational frequency feedback signal is not emitted during the indoor fan operation.  | • Refer to 9-6. ㉕ "Check of indoor fan motor".  |
| 4   | Indoor control system                                 | POWER lamp/Upper lamp flashes.<br>4-time flash<br>●●●●○○○○○○●●●●●●●●<br>2.5-second OFF    |  | It cannot properly read data in the nonvolatile memory of the indoor electronic control P.C. board.   | • Replace the indoor electronic control P.C. board.   |
| 5   | Outdoor power system                                  | POWER lamp/Upper lamp flashes.<br>5-time flash<br>●●●●●○○○○○○●●●●●●●●<br>2.5-second OFF   |  | It consecutively occurs 3 times that the compressor stops for overcurrent protection or start-up failure protection within 1 minute after start-up. | • Refer to "How to check of inverter/compressor".<br>Refer to outdoor unit service manual.<br>• Check the stop valve.           |
| 6   | Outdoor thermistors                                   | POWER lamp/Upper lamp flashes.<br>6-time flash<br>●●●●●●○○○○○○●●●●●●●●<br>2.5-second OFF  |  | The outdoor thermistors short or open circuit during the compressor operation.  | • Refer to "Check of outdoor thermistor".<br>Refer to outdoor unit service manual.  |
| 7   | Outdoor control system                                | POWER lamp/Upper lamp flashes.<br>7-time flash<br>●●●●●●○○○○○○●●●●●●●●<br>2.5-second OFF  |  | It cannot properly read data in the nonvolatile memory of the inverter P.C. board or the outdoor electronic control P.C. board.                     | • Replace the inverter P.C. board or the outdoor electronic control P.C. board.<br>Refer to outdoor unit service manual.        |
| 8   | Other abnormality                                     | POWER lamp/Upper lamp flashes.<br>14-time flash<br>●●●●●●○○○○○○●●●●●●●●<br>2.5-second OFF |  | An abnormality other than above mentioned is detected.  | • Check the stop valve.<br>• Confirm the abnormality in detail using the failure mode recall function for outdoor unit.         |
| 9   | Outdoor control system                                | POWER lamp/Upper lamp lights up ●   |  | Outdoor unit does not operate   | It cannot properly read data in the nonvolatile memory of the inverter P.C. board or the outdoor electronic control P.C. board. |

POWER lamp: MSZ-FE09/12NA

Upper lamp: MSZ-FE18NA

## OPERATION INDICATOR

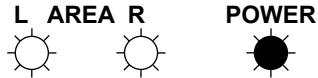

| No. | Abnormal point  | Operation indicator lamp  | Symptom   | Condition  | Remedy  |
|-----|---|---|---|--|---|
| 1   | <b>MXZ type</b><br>Operation mode setting<br><b>MSZ-FE09/12NA</b> | POWER lamp is lighted.<br>AREA lamps flash.<br><br>2.5-second OFF | Outdoor unit operates but indoor unit does not operate. | The operation mode of the each indoor unit is differently set to COOL (includes DRY) and HEAT at the same time, the operation mode of the indoor unit that has operated at first has the priority. | <ul style="list-style-type: none"> <li>Unify the operation mode. Refer to outdoor unit service manual.</li> </ul> |

## 9-5. TROUBLE CRITERION OF MAIN PARTS

### MSZ-FE09NA MSZ-FE12NA MSZ-FE18NA

| Part name  | Check method and criterion   | Figure                           |                        |               |                             |                        |                   |                           |               |             |  |                                |             |   |
|--|--|----------------------------------|------------------------|---------------|-----------------------------|------------------------|-------------------|---------------------------|---------------|-------------|--|--------------------------------|-------------|---|
| Room temperature thermistor (RT11)   | Measure the resistance with a tester.  |                                  |                        |               |                             |                        |                   |                           |               |             |  |                                |             |   |
| Indoor coil thermistor (RT12, RT13)  | Refer to 9-7. "Test point diagram and voltage", "Indoor electronic control P.C. board", the chart of thermistor.   |                                  |                        |               |                             |                        |                   |                           |               |             |  |                                |             |   |
| Indoor fan motor (MF)  | Check 9-6.㉔.   |                                  |                        |               |                             |                        |                   |                           |               |             |  |                                |             |   |
| Horizontal vane motor (MV1)<br>Vertical vane motor (MV2)<br>i-see Sensor motor (MT) ( <b>MSZ-FE09/12NA</b> ) | Measure the resistance between the terminals with a tester.<br>(Part temperature 50 ~ 86°F (10 ~ 30°C)) <table border="1" style="margin-top: 10px;"> <thead> <tr> <th></th> <th>Color of the lead wire</th> <th>Normal</th> </tr> </thead> <tbody> <tr> <td>Horizontal vane motor (MV1)</td> <td><b>(MSZ-FE09/12NA)</b></td> <td>313 ~ 375 Ω</td> </tr> <tr> <td>Vertical vane motor (MV2)</td> <td>BRN-other one</td> <td>268 ~ 322 Ω</td> </tr> <tr> <td>i-see Sensor motor (MT) (<b>MSZ-FE09/12NA</b>)</td> <td><b>(MSZ-FE18NA)</b><br/>RED-BLK</td> <td>223 ~ 268 Ω</td> </tr> </tbody> </table>                               |                                  | Color of the lead wire | Normal        | Horizontal vane motor (MV1) | <b>(MSZ-FE09/12NA)</b> | 313 ~ 375 Ω       | Vertical vane motor (MV2) | BRN-other one | 268 ~ 322 Ω | i-see Sensor motor (MT) ( <b>MSZ-FE09/12NA</b> ) | <b>(MSZ-FE18NA)</b><br>RED-BLK | 223 ~ 268 Ω | <b>MSZ-FE09/12NA</b><br><br><b>MSZ-FE18NA</b><br> |
|  | Color of the lead wire   | Normal                           |                        |               |                             |                        |                   |                           |               |             |  |                                |             |   |
| Horizontal vane motor (MV1)  | <b>(MSZ-FE09/12NA)</b>   | 313 ~ 375 Ω                      |                        |               |                             |                        |                   |                           |               |             |  |                                |             |   |
| Vertical vane motor (MV2)  | BRN-other one  | 268 ~ 322 Ω                      |                        |               |                             |                        |                   |                           |               |             |  |                                |             |   |
| i-see Sensor motor (MT) ( <b>MSZ-FE09/12NA</b> )   | <b>(MSZ-FE18NA)</b><br>RED-BLK   | 223 ~ 268 Ω                      |                        |               |                             |                        |                   |                           |               |             |  |                                |             |   |
| i-see Sensor (RR) ( <b>MSZ-FE09/12NA</b> )   | Cover the i-see Sensor with black vinyl tape. Then, turn ON the power supply. (i-see Sensor is energized.) Measure the voltage between connector terminals of i-see Sensor with a tester.<br>(Part temperature 50 ~ 104°F (10 ~ 40°C)) <div style="margin-top: 10px;"> </div> <table border="1" style="margin-top: 10px;"> <thead> <tr> <th>i-see Sensor connector terminals</th> <th>Normal range</th> </tr> </thead> <tbody> <tr> <td>②(GND) - ④(+)</td> <td>1.874 ~ 3.387 VDC</td> </tr> <tr> <td>①(+)- ②(GND)</td> <td>1.010 ~ 1.420 VDC</td> </tr> </tbody> </table> <p><b>NOTE:</b> Pay attention to static electricity.</p> | i-see Sensor connector terminals | Normal range           | ②(GND) - ④(+) | 1.874 ~ 3.387 VDC           | ①(+)- ②(GND)           | 1.010 ~ 1.420 VDC |                           |               |             |  |                                |             |   |
| i-see Sensor connector terminals   | Normal range   |                                  |                        |               |                             |                        |                   |                           |               |             |  |                                |             |   |
| ②(GND) - ④(+)  | 1.874 ~ 3.387 VDC  |                                  |                        |               |                             |                        |                   |                           |               |             |  |                                |             |   |
| ①(+)- ②(GND)   | 1.010 ~ 1.420 VDC  |                                  |                        |               |                             |                        |                   |                           |               |             |  |                                |             |   |

## 9-6. TROUBLESHOOTING FLOW

### A Check of indoor fan motor

The indoor fan motor error has occurred, and the indoor fan does not operate.

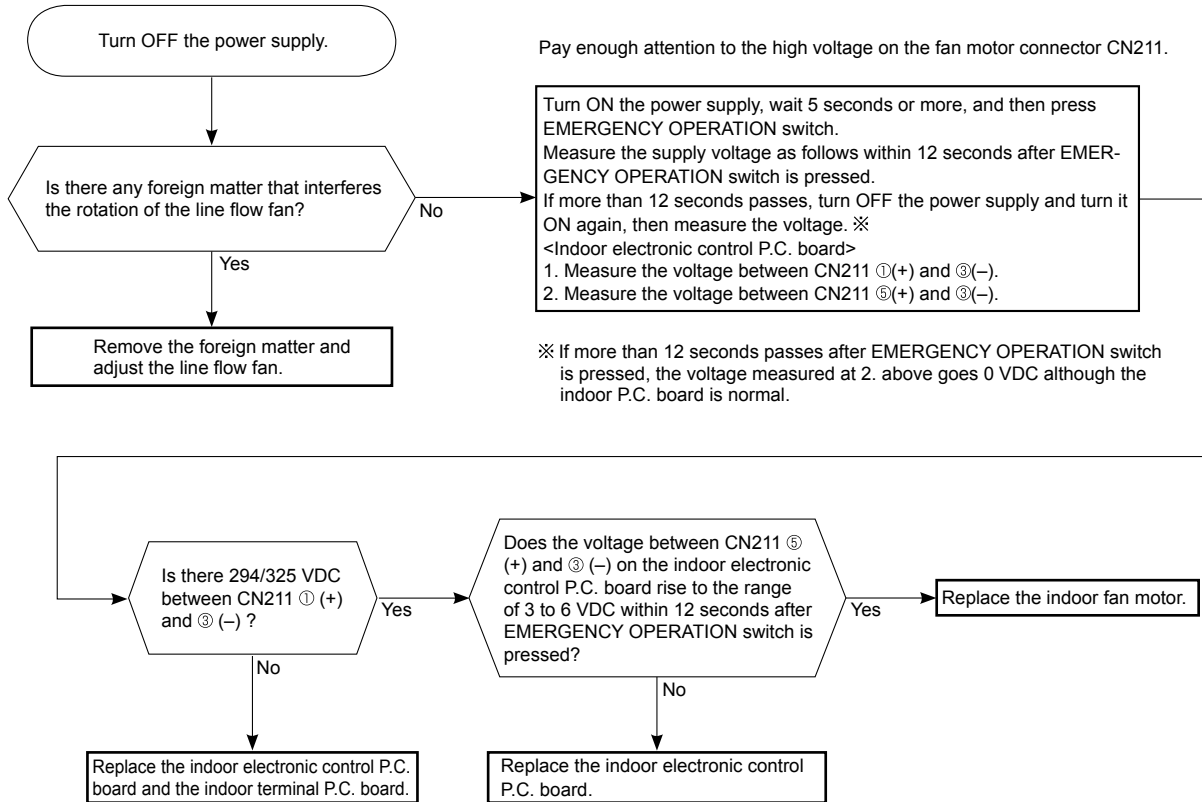

The indoor fan motor error has occurred, and the indoor fan repeats "12-second ON and 30-second OFF" 3 times, and then stops.

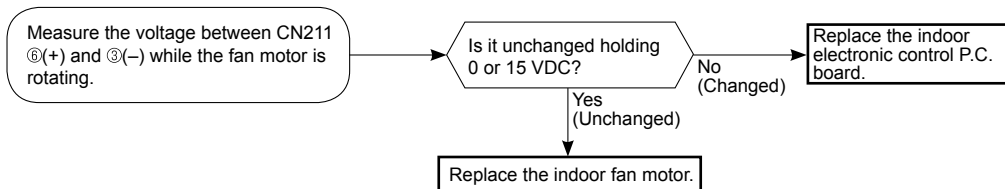

## B Check of remote controller and indoor electronic control P.C. board

※Check if the remote controller is exclusive for this air conditioner.

### MSZ-FE09NA MSZ-FE12NA

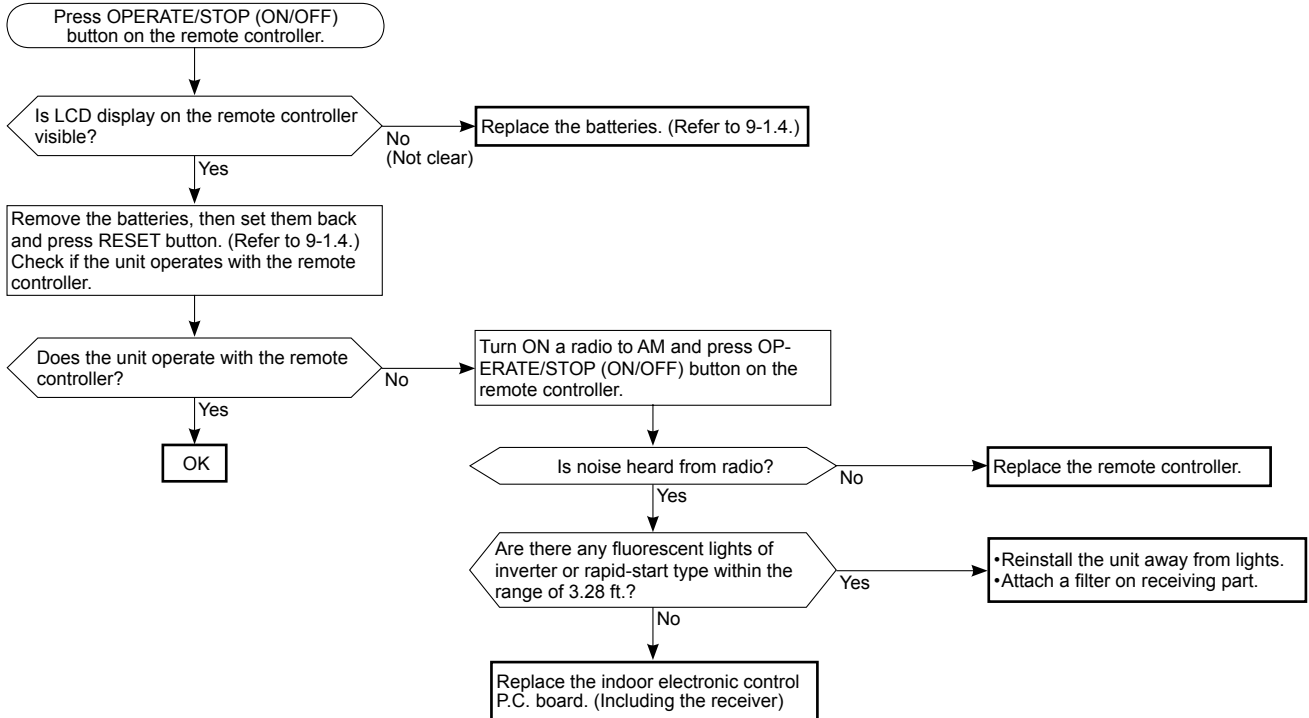

### MSZ-FE18NA

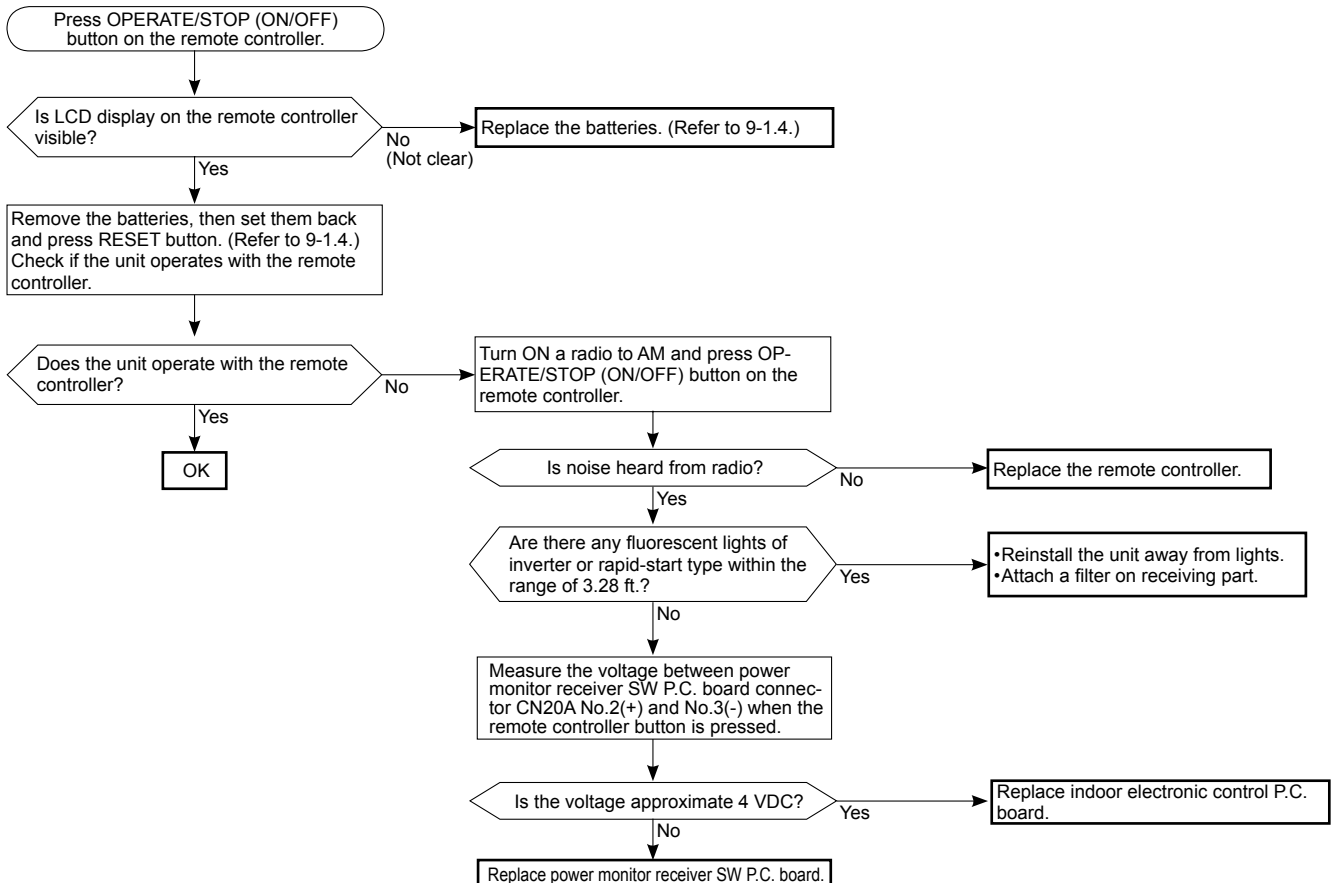

## © Check of indoor electronic control P.C. board and indoor fan motor

### MSZ-FE09NA MSZ-FE12NA

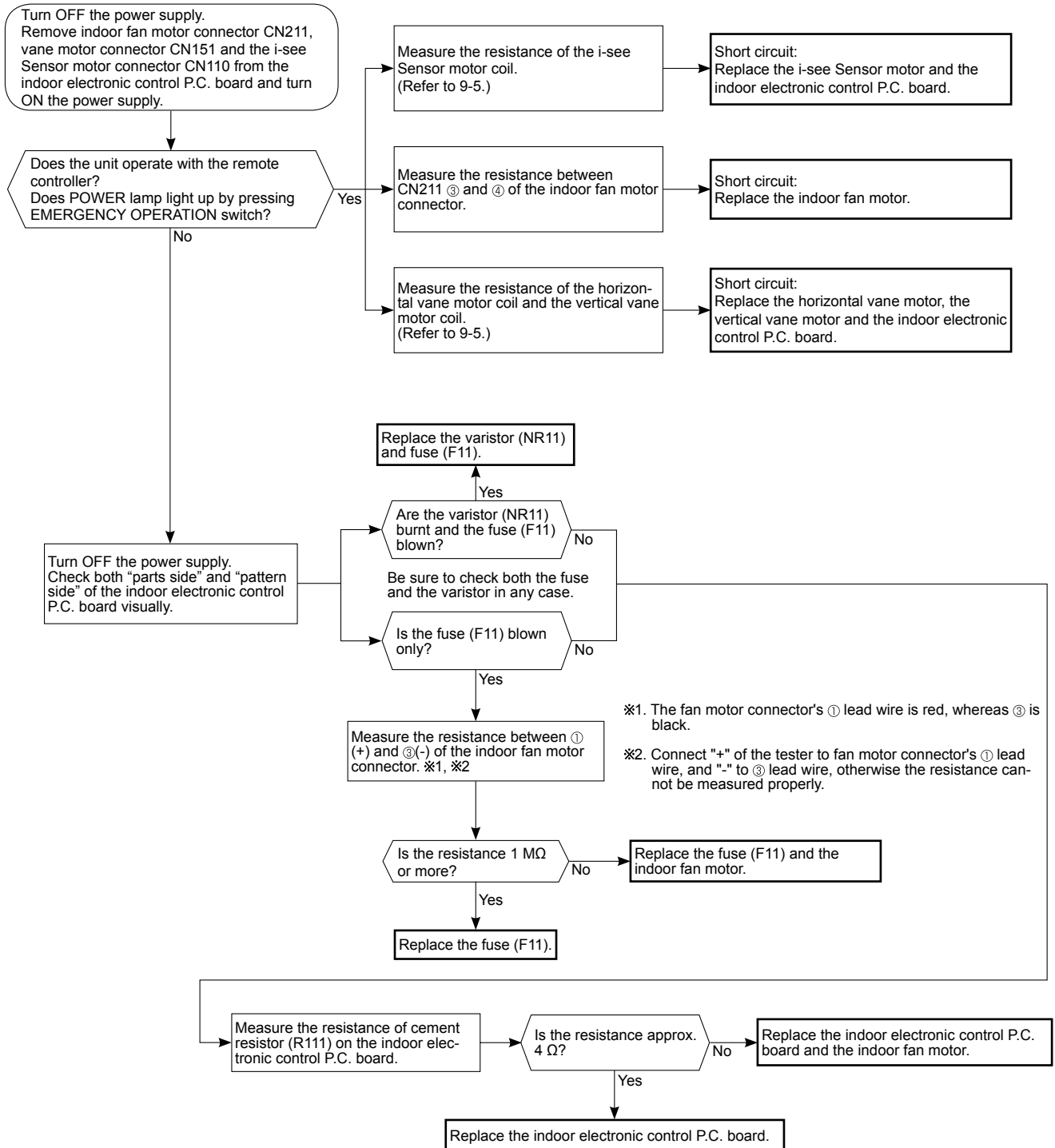

# MSZ-FE18NA

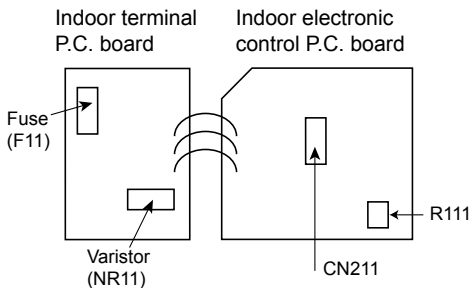
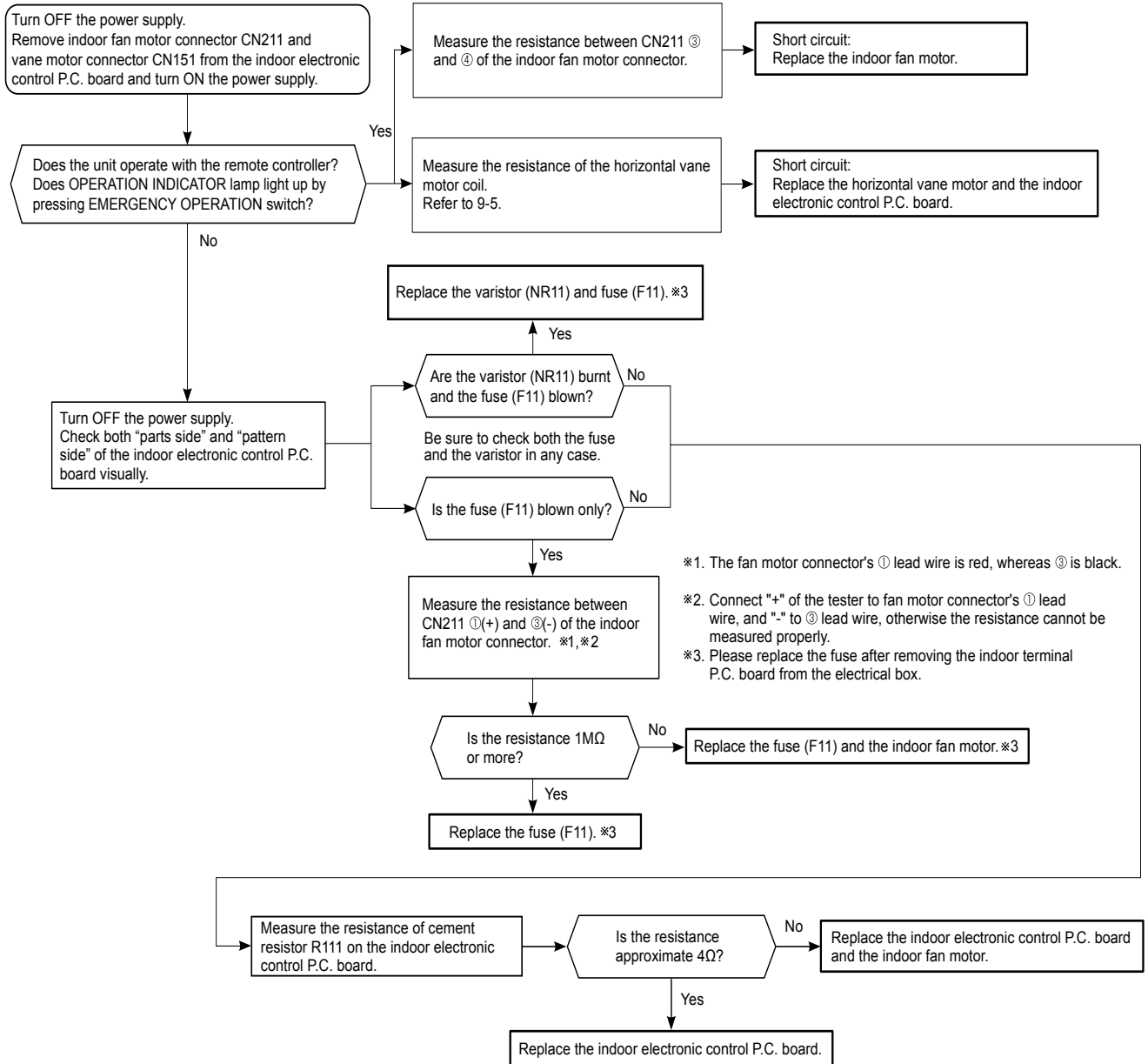

## D How to check miswiring and serial signal error

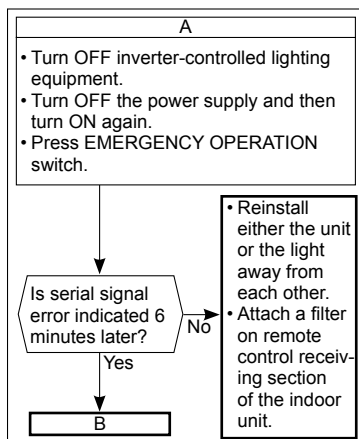
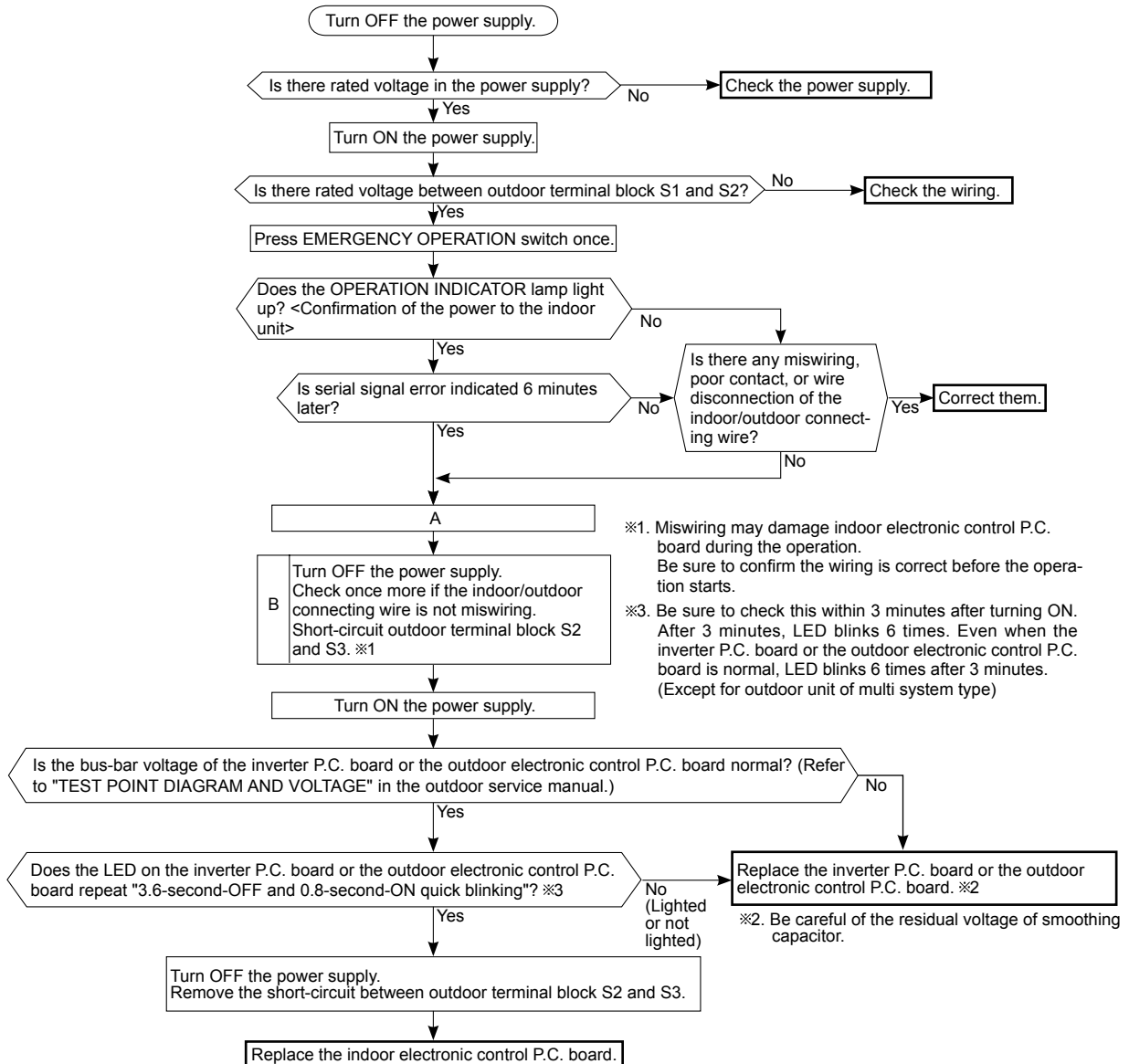



## Ⓔ Electromagnetic noise enters into TV sets or radios

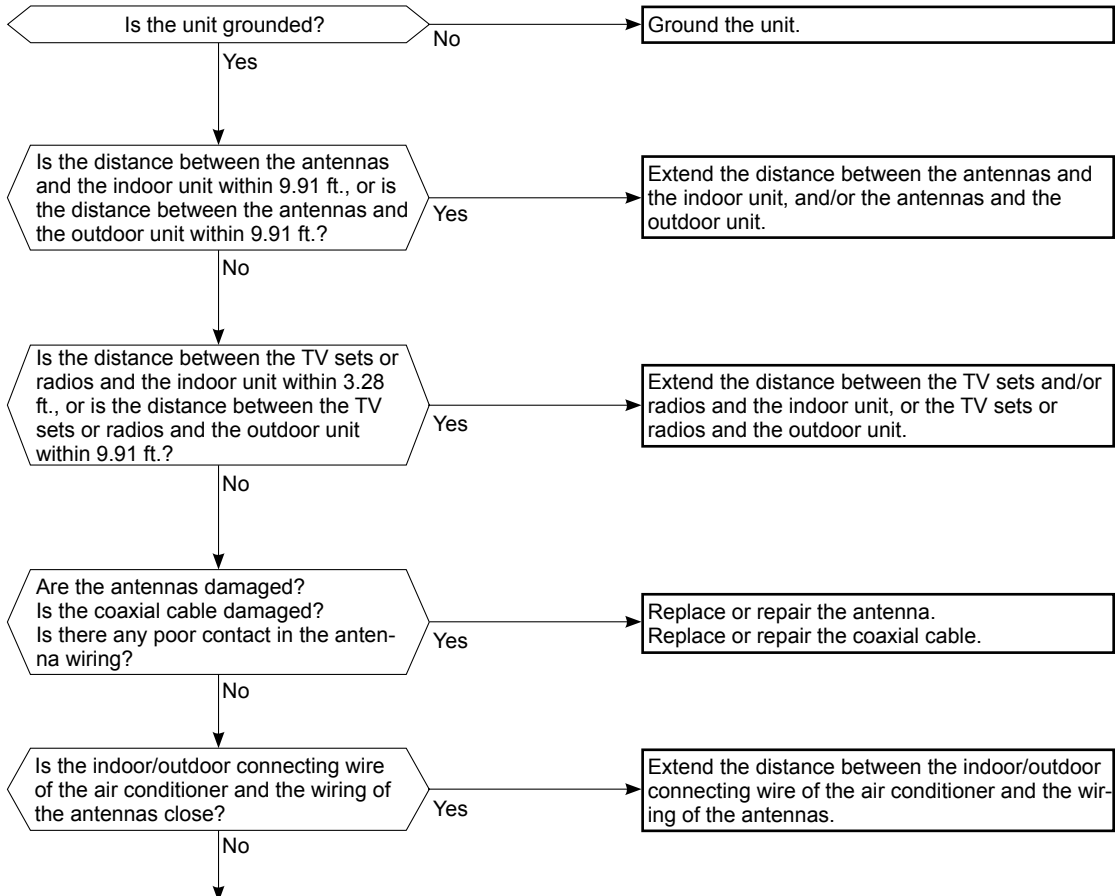

Even if all of the above conditions are fulfilled, the electromagnetic noise may enter, depending on the electric field strength or the installation condition (combination of specific conditions such as antennas or wiring). Check the followings before asking for service.

1. Devices affected by the electromagnetic noise  
TV sets, radios (FM/AM broadcast, shortwave)
2. Channel, frequency, broadcast station affected by the electromagnetic noise
3. Channel, frequency, broadcast station unaffected by the electromagnetic noise
4. Layout of:  
indoor/outdoor unit of the air conditioner, indoor/outdoor wiring, grounding wire, antennas, wiring from antennas, receiver
5. Electric field intensity of the broadcast station affected by the electromagnetic noise
6. Presence or absence of amplifier such as booster
7. Operation condition of air conditioner when the electromagnetic noise enters in
  - 1) Turn OFF the power supply once, and then turn ON the power supply. In this situation, check for the electromagnetic noise.
  - 2) Within 3 minutes after turning ON the power supply, press OPERATE/STOP (ON/OFF) button on the remote controller for power ON, and check for the electromagnetic noise.
  - 3) After a short time (3 minutes later after turning ON), the outdoor unit starts running. During operation, check for the electromagnetic noise.
  - 4) Press OPERATE/STOP (ON/OFF) button on the remote controller for power OFF, when the outdoor unit stops but the indoor/outdoor communication still runs on. In this situation, check for the electromagnetic noise.

## 9-7. TEST POINT DIAGRAM AND VOLTAGE MSZ-FE09NA MSZ-FE12NA

### 1. Indoor electronic control P.C. board

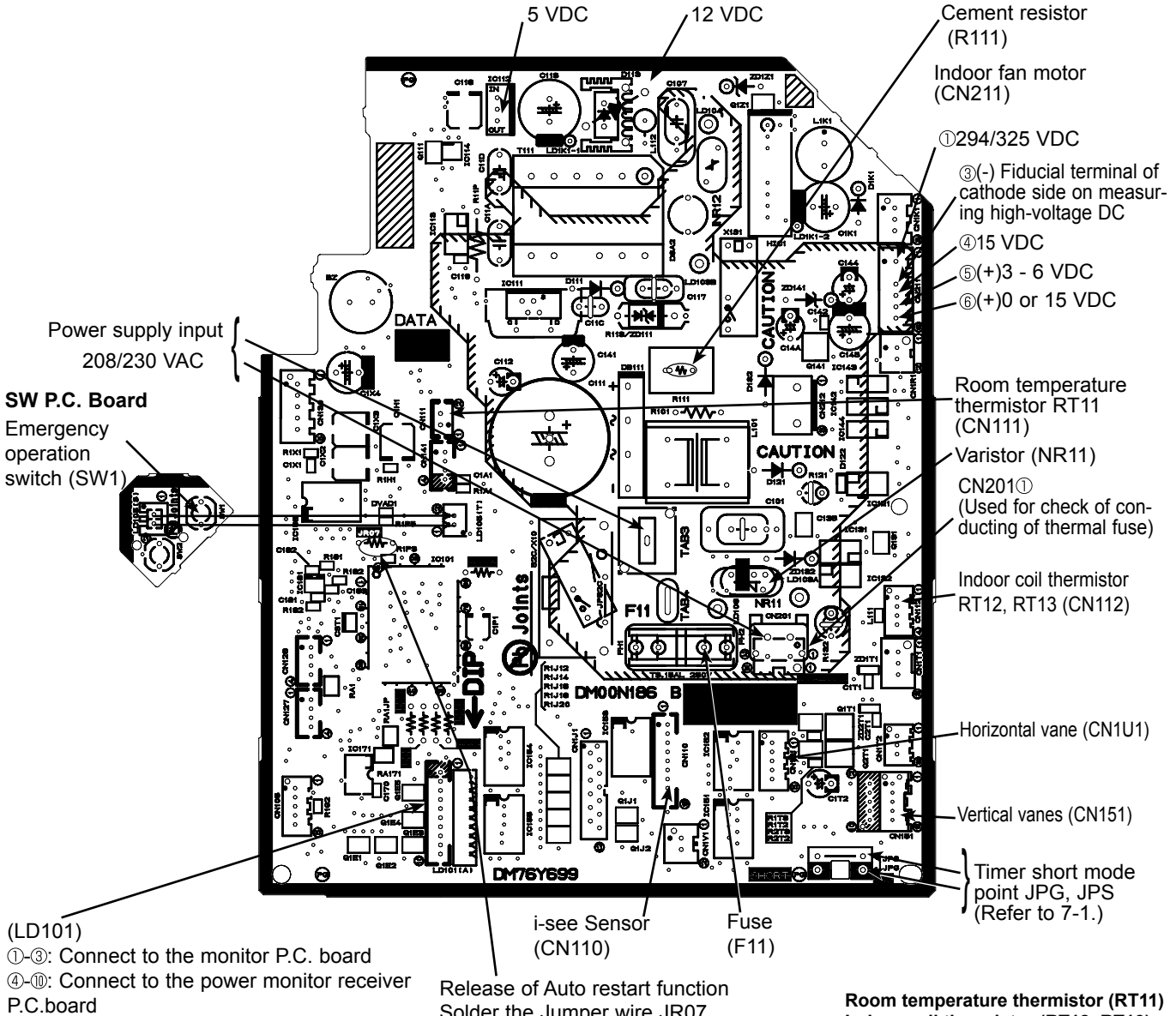

### 2. Power monitor receiver P.C. board

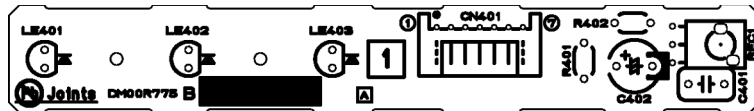

### 3. Monitor P.C. board

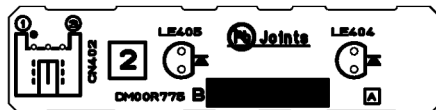

Room temperature thermistor (RT11)  
Indoor coil thermistor (RT12, RT13)

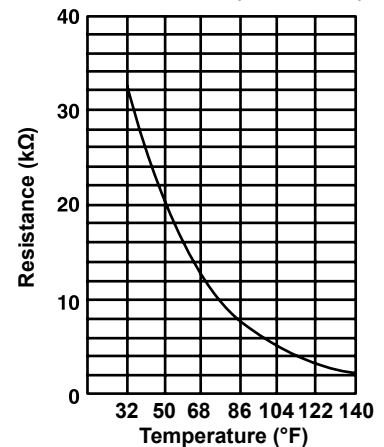

# MSZ-FE18NA

## 4. Indoor terminal P.C. board, Indoor electronic control P.C. board, Power monitor receiver SW P.C. board

### Indoor terminal P.C. board

### Indoor electronic control P.C. board

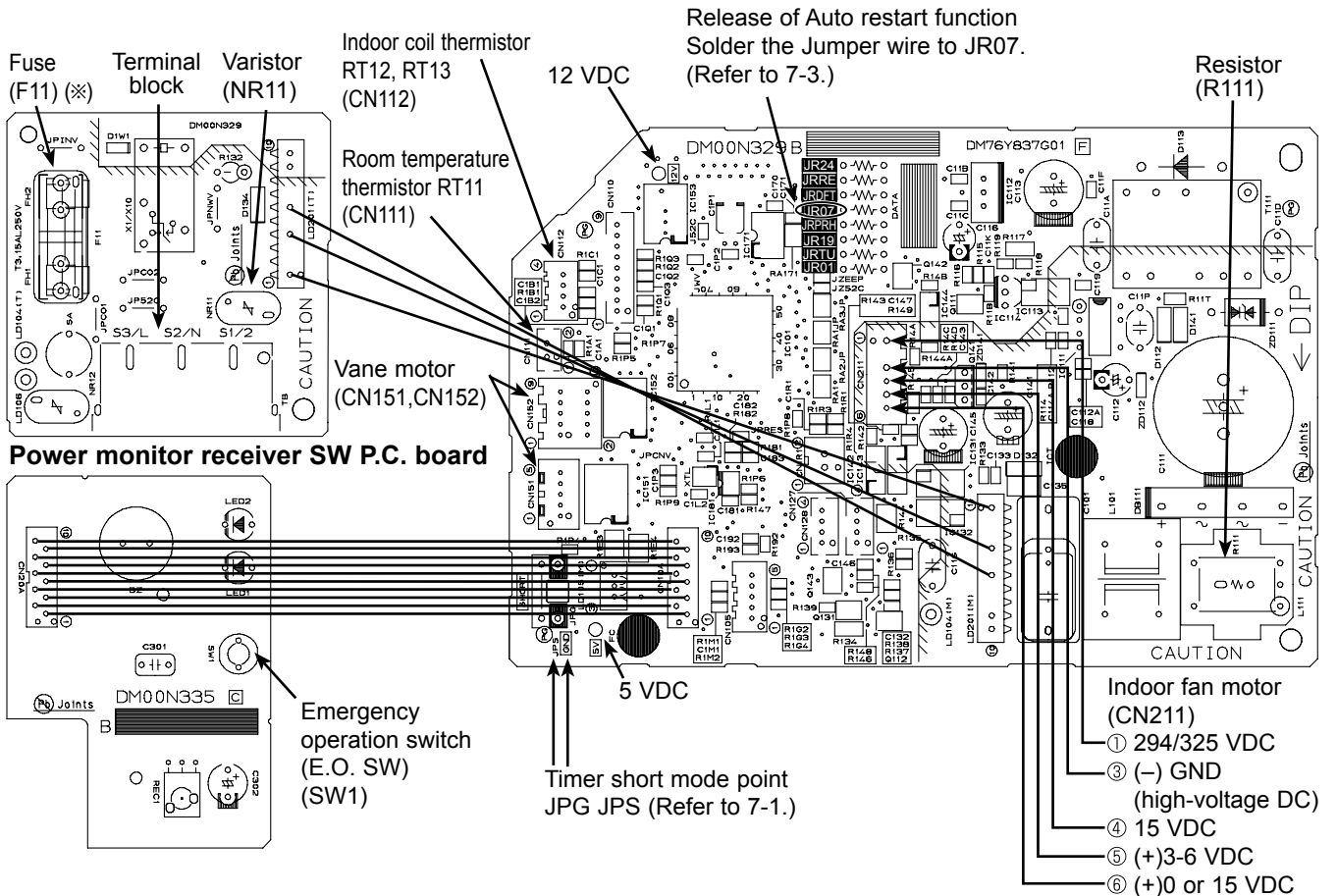

\* Please replace the fuse after removing the indoor terminal P.C. board from the electrical box.

**Room temperature thermistor (RT11)  
Indoor coil thermistor (RT12, RT13)**

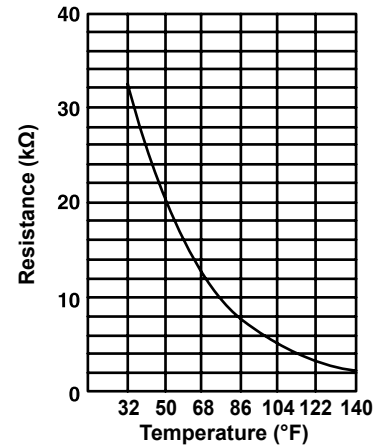

## &lt;"Terminal with locking mechanism" Detaching points&gt;

The terminal which has the locking mechanism can be detached as shown below.

There are two types (refer to (1) and (2)) of the terminal with locking mechanism.

The terminal without locking mechanism can be detached by pulling it out.

Check the shape of the terminal before detaching.

(1) Slide the sleeve and check if there is a locking lever or not.

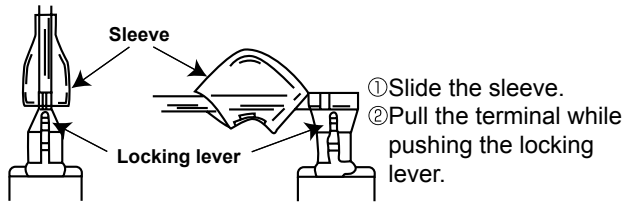

(2) The terminal with this connector has the locking mechanism.

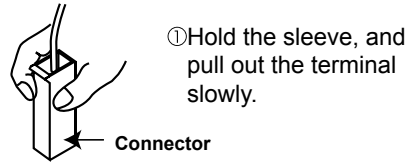

## 10-1. MSZ-FE09NA MSZ-FE12NA

**NOTE:** Turn OFF power supply before disassembly.

| OPERATING PROCEDURE   | PHOTOS                |
|---|-----------------------|
| <p><b>1. Removing the panel</b></p> <p>(1) Hold both sides of the front panel and lift the front panel until it is level. Pull the hinges forward to remove the front panel.</p> <p>(2) Remove the horizontal vanes.</p> <p>(3) Remove the screw caps of the panel. Remove the screws.</p> <p>(4) Unhook the lower part (A) of the panel.</p> <p>(5) Hold the lower part of both ends of the panel and pull it slightly toward you, and then remove the panel by pushing it upward.</p> | <p><b>Photo 1</b></p> |

## OPERATING PROCEDURE

### 2. Removing the electronic control P.C. board, the power monitor receiver P.C. board, i-see Sensor, SW P.C. board and the terminal block

- (1) Remove the panel (Refer to 1.) and the corner box.
- (2) Remove the screw of the conduit cover. Remove the conduit cover and the indoor/outdoor connecting wire.
- (3) Remove the sensor holder from the electrical cover.
- (4) Remove the screw of the electrical cover, and then the electrical cover.
- (5) Remove the ground wire connected to the indoor electronic control P.C. board from the electrical box.
- (6) Remove the power monitor receiver P.C. board holder.
- (7) Pull out the i-see Sensor from the power monitor receiver P.C. board holder.
- (※) Install the i-see Sensor in its former position when assembling it. (Photo 5)
- (8) Open the rear cover of the power monitor receiver P.C. board holder and pull out the power monitor receiver P.C. board.
- (9) Open the sensor holder and pull out the SW P.C. board.
- (10) Pull the electronic control P.C. board slightly toward you from the electrical box, and disconnect TAB3 and all the connectors on the electronic control P.C. board.
- (11) Pull out the electronic control P.C. board from the electrical box.
- (12) Remove the ground wire connected to the heat exchanger from the electrical box.
- (13) Unhook the catches of the electrical box, and pull out the electrical box.
- (14) Remove the screw of the terminal block cover, and then the terminal block cover and the terminal block holder.
- (15) Remove the terminal block by sliding it.

Photo 4

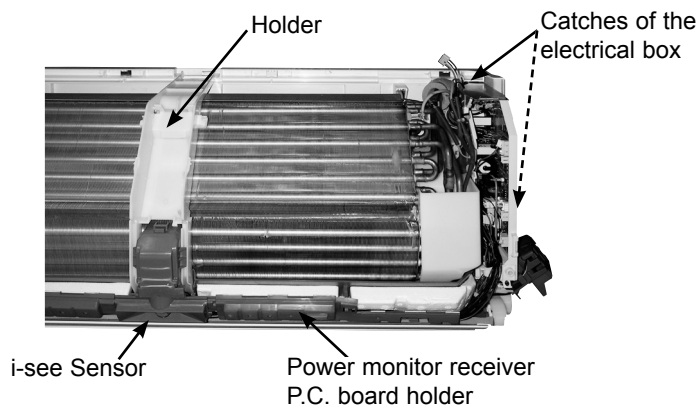

## PHOTOS

Photo 2

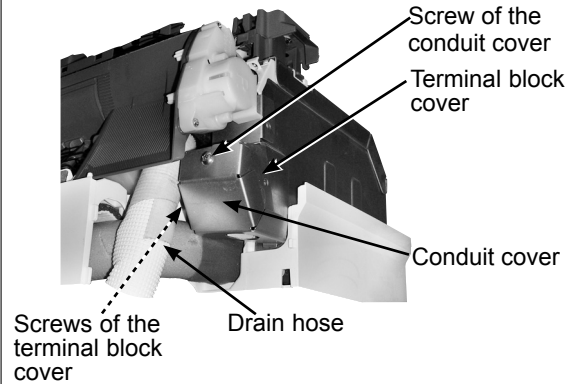
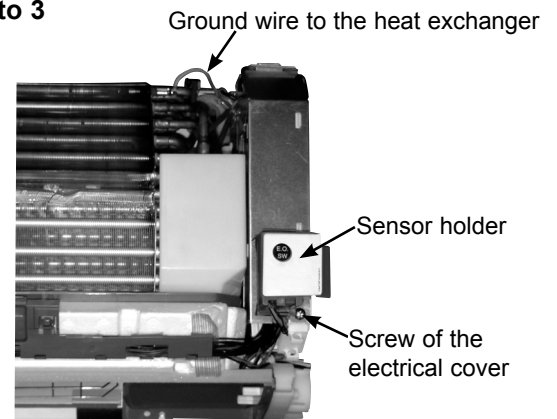
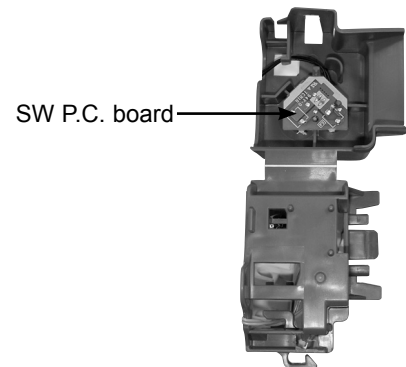

Photo 3



Sensor holder (inside)



## OPERATING PROCEDURE

### 3. Removing the electrical box

- (1) Remove the panel (Refer to 1.) and the corner box.
- (2) Remove the indoor/outdoor connecting wire, the sensor holder, the electrical cover and the ground wire. (Refer to 2.)
- (3) Disconnect the following connectors on the electronic control P.C. board:
  - CN211 (Fan motor)
  - CN112 (Indoor coil thermistor)
  - CN1U1 (Horizontal vane motor)
  - CN151 (Vertical vane motor)
- (4) Unhook the catches of the electrical box, and pull out the electrical box. (Photo 4)

### 4. Removing the nozzle assembly

- (1) Remove the panel (Refer to 1.) and the corner box.
- (2) Remove the conduit cover, and then the indoor/outdoor connecting wire. (Refer to 2.)
- (3) Remove the sensor holder and the electrical cover. (Photo 3)
- (4) Disconnect the following connectors on the electronic control P.C. board:
  - CN1U1 (Horizontal vane motor)
  - CN151 (Vertical vane motor)
- (5) Remove the power monitor receiver P.C. board holder and the holder. (Photo 4)
- (6) Pull out the drain hose from the nozzle assembly and remove the nozzle assembly.

### 5. Removing the vertical vane motor unit

- (1) Remove the nozzle assembly. (Refer to 4.)
- (2) Remove the crank of the vertical vane motor unit from the arm of the vertical vane.
- (3) Remove the screw of the vertical vane motor unit, and pull the vertical vane motor unit.
- (4) Remove the screws of the vertical vane motor unit cover.
- (5) Remove the crank of the vertical vane motor unit from the shaft of the vane motor.
- (※) Only the crank of the left side vertical vane motor unit.
- (6) Remove the vertical vane motor from the vertical vane motor unit.
- (7) Disconnect the connector of vertical vane motor from the vertical vane motor.

## PHOTOS

Photo 5

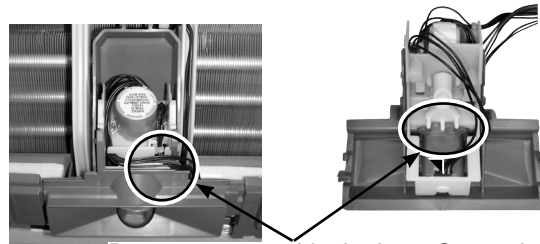

Be sure to assemble the i-see Sensor in the correct position.

Photo 6

Screws of the vertical vane motor unit cover

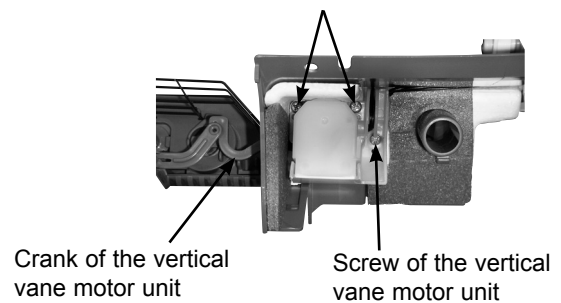

Crank of the vertical vane motor unit

Screw of the vertical vane motor unit

Photo 7

Screws of the vertical vane motor unit cover

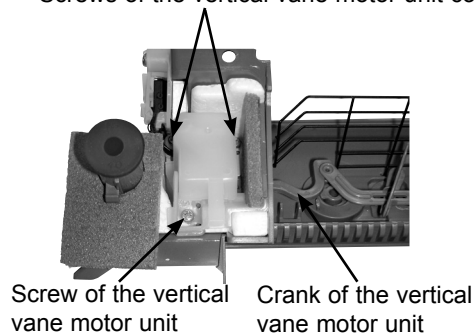

Screw of the vertical vane motor unit

Crank of the vertical vane motor unit

## OPERATING PROCEDURE

### 6. Removing the horizontal vane motor

- (1) Remove the nozzle assembly. (Refer to 4.)
- (2) Remove the screws of the horizontal vane motor unit, and pull out the horizontal vane motor unit.
- (3) Remove the screws of the horizontal vane motor unit cover.
- (4) Remove the horizontal vane motor from the horizontal vane motor unit.
- (5) Disconnect the connector from the horizontal vane motor.

### 7. Removing the indoor fan motor and the line flow fan

- (1) Remove the panel (Refer to 1.) and the corner box.
- (2) Remove the sensor holder, the power monitor receiver P.C. board holder, the electrical box (Refer to 3.) and the nozzle assembly (Refer to 4.).
- (3) Remove the screws fixing the motor bed.
- (4) Loosen the screw fixing the line flow fan.
- (5) Remove the motor bed together with fan motor and motor band.
- (6) Release the hooks of the motor band. Remove the motor band. Pull out the indoor fan motor.
- (7) Remove the indoor coil thermistor from the heat exchanger.
- (\*) Install the indoor coil thermistor (RT12) in its former position when assembling it. (Photo 12)
- (8) Remove the screws fixing the left side of the heat exchanger.
- (9) Lift the heat exchanger, and pull out the line flow fan to the lower-left.

Photo 12



Indoor coil thermistor (RT12)

## PHOTOS

Photo 8

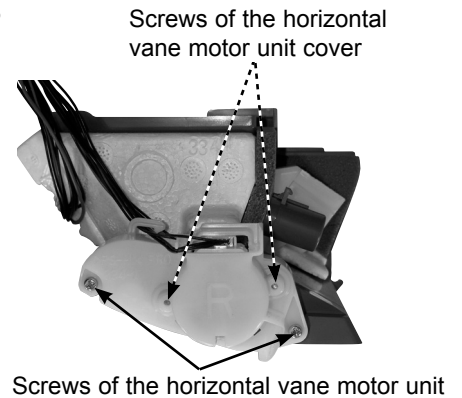

Photo 9

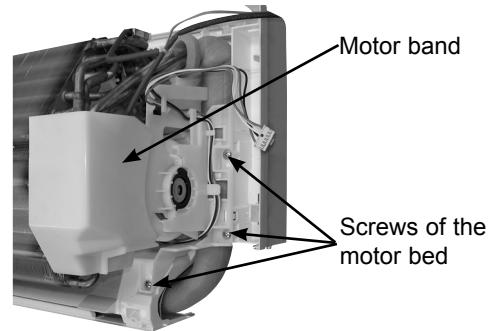

Photo 10

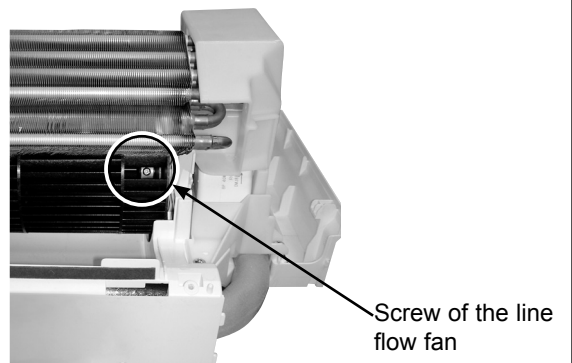
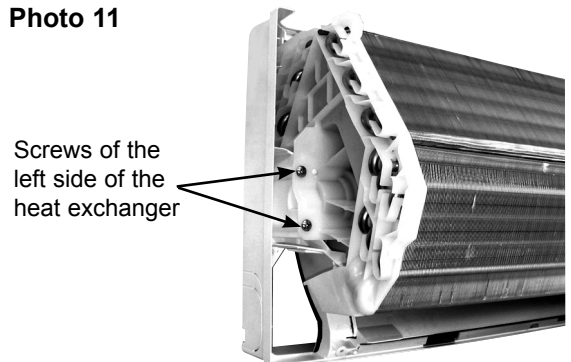
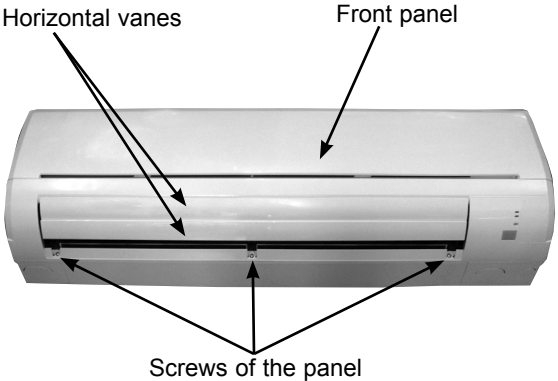
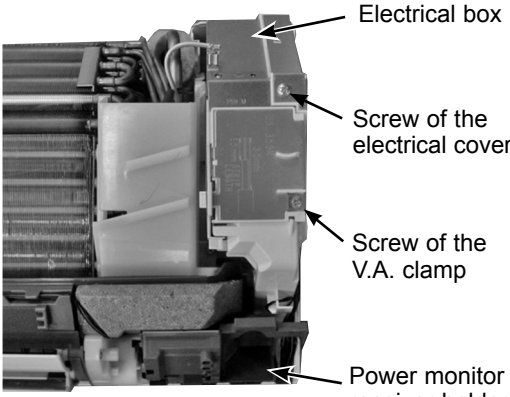

Photo 11



## 10-2. MSZ-FE18NA

**NOTE:** Turn OFF power supply before disassembly.

| OPERATING PROCEDURE   | PHOTOS   |
|---|--|
| <p><b>1. Removing the panel</b></p> <ol style="list-style-type: none"><li>(1) Remove the horizontal vanes.</li><li>(2) Remove the screw caps of the panel. Remove the screws of the panel.</li><li>(3) Hold the lower part of both ends of the panel and pull it slightly toward you, and then remove the panel by pushing it upward.</li></ol>   | <p><b>Photo 1</b></p>  <p>Horizontal vanes</p> <p>Front panel</p> <p>Screws of the panel</p>   |
| <p><b>2. Removing the indoor electronic control P.C. board, the power monitor receiver SW P.C. board and the indoor terminal P.C. board</b></p> <ol style="list-style-type: none"><li>(1) Remove the panel (Refer to 1.) and the corner box.</li><li>(2) Remove the screw of the V.A. clamp and the V.A. clamp.</li><li>(3) Remove the screw of the conduit cover and the conduit cover. (Photo 3)</li><li>(4) Remove the screw of the conduit plate, the conduit plate and the indoor/outdoor connecting wire.</li><li>(5) Remove the screw of the electrical cover, and then the electrical cover.</li><li>(6) Remove the ground wire connected to the indoor electronic control P.C. board from the electrical box. (Photo 3)</li><li>(7) Remove the power monitor receiver holder.</li><li>(8) Open the rear cover of the power monitor receiver holder and pull out the power monitor receiver SW P.C. board.</li><li>(9) Disconnect all the connectors on the indoor electronic control P.C. board and unhook all lead wires.</li><li>(10) Remove the screw of the terminal block on the indoor terminal P.C. board.</li><li>(11) Remove the indoor terminal P.C. board and the indoor electronic control P.C. board.</li></ol> | <p><b>Photo 2</b></p>  <p>Electrical box</p> <p>Screw of the electrical cover</p> <p>Screw of the V.A. clamp</p> <p>Power monitor receiver holder</p> |



## OPERATING PROCEDURE

### 3. Removing the indoor electrical box

- (1) Remove the panel (Refer to 1.) and the corner box.
- (2) Remove the indoor/outdoor connecting wire.  
(Refer to 2 (2)-(4).)
- (3) Remove the ground wire connected to the indoor heat exchanger from the electrical box.
- (4) Remove the screw of the electrical cover and remove the electrical cover.
- (5) Disconnect all the connectors on the indoor electronic control P.C. board and unhook all lead wires.
- (6) Remove the screw fixing the electrical box, then the upper catch of the electrical box, and pull out the electrical box.

### 4. Removing the nozzle assembly

- (1) Remove the panel (Refer to 1.) and the corner box.
- (2) Remove the V.A. clamp, and then the indoor/outdoor connecting wire. (Refer to 2 (2)-(4).)
- (3) Remove the electrical cover. (Photo 2)
- (4) Disconnect the following connectors on the electronic control P.C. board:  
CN151 (Horizontal vane motor)  
CN152 (Vertical vane motor)
- (5) Remove the power monitor receiver holder. (Photo 2)
- (6) Pull out the drain hose from the nozzle assembly and remove the nozzle assembly.
- (7) Remove the vane motors. (Refer to 5 and 6.)

## PHOTOS

Photo 3

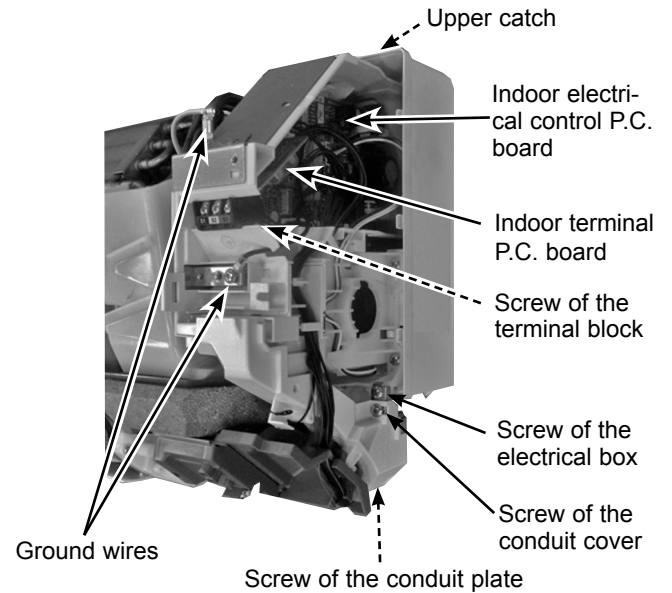
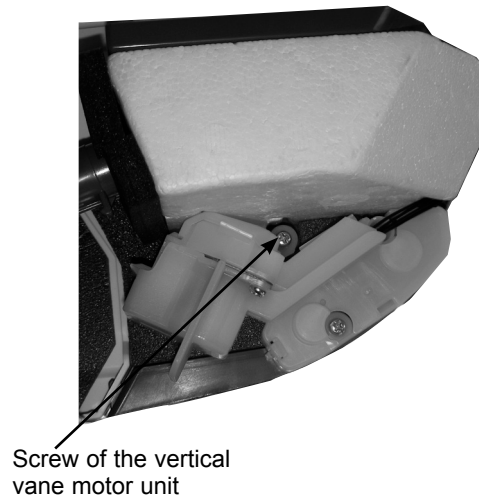

Photo 4



## OPERATING PROCEDURE

### 5. Removing the vertical vane motor unit

- (1) Remove the nozzle assembly. (Refer to 4.)
- (2) Remove the crank of the vertical vane motor unit from the arm of the vertical vane.
- (3) Remove the screw of the vertical vane motor unit, and pull the vertical vane motor unit.
- (4) Remove the screws of the vertical vane motor unit cover.
- (5) Remove the crank of the vertical vane motor unit from the shaft of the vane motor.
- (6) Remove the vertical vane motor from the vertical vane motor unit.
- (7) Disconnect the connector of vertical vane motor from the vertical vane motor.

### 6. Removing the horizontal vane motor

- (1) Remove the nozzle assembly. (Refer to 4.)
- (2) Remove the screws of the horizontal vane motor unit, and pull out the horizontal vane motor unit.
- (3) Disconnect the connector from the horizontal vane motor.
- (4) Remove the screws of the horizontal vane motor unit cover.
- (5) Remove the horizontal vane motor from the horizontal vane motor unit.

## PHOTOS

Photo 5

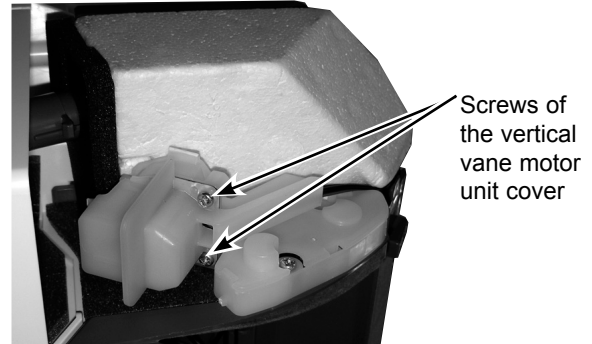
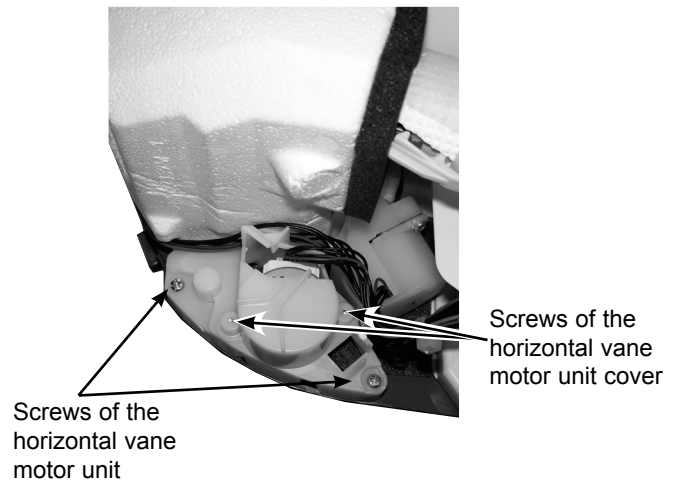

Photo 6



## OPERATING PROCEDURE

### 7. Removing the water cut, the indoor fan motor, the indoor coil thermistor, and the line flow fan

- (1) Remove the panel (Refer to 1.) and the corner box.
- (2) Remove the power monitor receiver holder, the electrical box and the nozzle assembly. (Refer to 3 and 4.)
- (3) Remove the screw of the water cut and remove the water cut.
- (4) Remove the screws fixing the motor bed.
- (5) Loosen the screw fixing the line flow fan.
- (6) Remove the motor bed together with fan motor and motor band.
- (7) Remove the screw of the motor band.
- (8) Release the hooks of the motor band. Remove the motor band. Pull out the indoor fan motor.
- (9) Remove the indoor coil thermistor from the heat exchanger.
  - \*Install the indoor coil thermistor in its former position when assembling it. (Photo 9)
- (10) Remove the screws fixing the left side of the heat exchanger.
- (11) Lift the heat exchanger, and pull out the line flow fan to the lower-left.

**Photo 7**

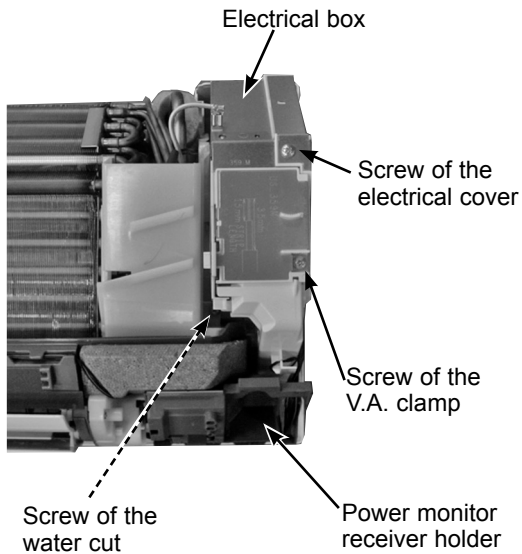

## PHOTOS

**Photo 8**

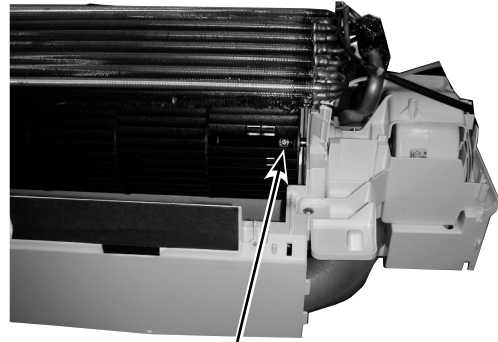

Screw of the line flow fan

**Photo 9**

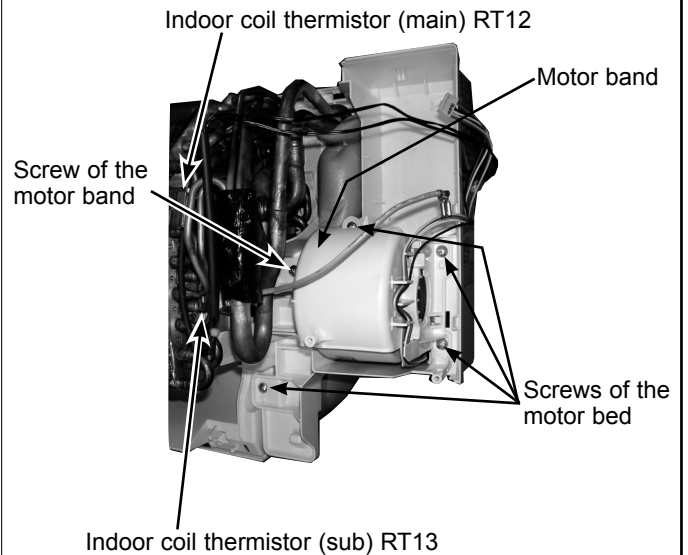

**Photo 10**

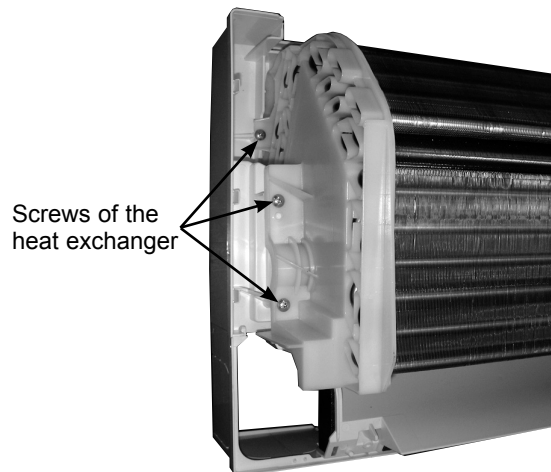



© Copyright 2009 MITSUBISHI ELECTRIC CO., LTD  
Distributed in Apr. 2011. No. OBH542 REVISED EDITION-B  
Distributed in Sep. 2010. No. OBH542 REVISED EDITION-A 5  
Distributed in Jul. 2009. No. OBH542 5  
Made in Japan

New publication, effective Apr. 2011  
Specifications subject to change without notice.