



Job Name:

System Reference:

Date:

Indoor Unit: MSY-D36NA	Outdoor Unit: MUY-D36NA	Wireless Remote Controller
		

### GENERAL FEATURES

- Slim wall-mounted indoor units provide zone comfort control.
- The outdoor unit powers the indoor unit, and should a power outage occur, the system is automatically restarted when power returns.
- INVERTER-driven compressor and LEV provide high efficiency and comfort while using only the energy needed to maintain maximum performance
- Multiple fan speed options: Low, Medium, High, Powerful, Auto
- Multiple control options available:
  - Hand-held Remote Controller (provided with unit)
  - kumo cloud® smart device app for remote access
  - Third-party interface options
  - Wired or wireless controllers
- Hot-Start Technology: no cold air rush at equipment startup or when restarting after Defrost Cycle
- Powerful Operation: quickly cools or heats the room by automatically adjusting fan speed and set temperature for 15 minutes
- Smart Set: recalls a preferred preset temperature setting at the touch of a button
- Wide Vane mode provides 150° of airflow

## SPECIFICATIONS: MSY-D36NA & MUY-D36NA

Cooling <sup>1</sup>	Maximum Capacity	Btu/h	34,600	
	Rated Capacity	Btu/h	34,600	
	Minimum Capacity	Btu/h	9,800	
	Maximum Power Input	W	4,240	
	Rated Power Input	W	4,240	
	Moisture Removal	Pints/h	11.9	
	Sensible Heat Factor		0.62	
	Power Factor	%	99 / 99	
Efficiency	SEER		15.1	
	EER <sup>1</sup>		8.2	
Electrical	Voltage, Phase, Frequency		208/230V, 1 phase, 60Hz	
	Guaranteed Voltage Range	V AC	187 - 253	
	Voltage: Indoor - Outdoor, S1-S2	V AC	208 / 230	
	Voltage: Indoor - Outdoor, S2-S3	V DC	24	
	Voltage: Indoor - Remote controller	V DC	12	
	Recommended Fuse/Breaker Size	A	25	
	Recommended Wire Size (Indoor - Outdoor)	AWG	14	
Indoor Unit	MCA	A	1	
	MOCP	A	15	
	Blower Motor Full Load Amperage	A	0.76	
	Blower Motor Output	W	56	
	Airflow Rate at Cooling, Dry	CFM	887-848-639-389	
	Airflow Rate at Cooling, Wet	CFM	798-763-576-350	
	Sound Pressure Level (Cooling)	dB(A)	51-49-42-32	
	Drain Pipe Size	In. (mm)	5/8 (15.88)	
	Heat Exchanger Type		Plate fin coil	
	External Finish Color		Munsell 3Y 7.8/1.1	
	Unit Dimensions	W: In. (mm)		46-1/16 (1,170)
		D: In. (mm)		11-5/8 (295)
		H: In. (mm)		14-3/8 (365)
	Package Dimensions	W: In. (mm)		51 (1,295)
		D: In. (mm)		14-1/4 (362)
H: In. (mm)			18-1/2 (470)	
Unit Weight	Lbs. (kg)		40 (18)	
Package Weight	Lbs. (kg)		53 (24)	
Indoor Unit Operating Temperature Range	Cooling Intake Air Temp (Maximum / Minimum)*	°F	90 DB, 73 WB / 67 DB, 57 WB	
Outdoor Unit	MCA	A	21	
	MOCP	A	25	
	Fan Motor Full Load Amperage	A	0.93	
	Fan Motor Output	W	77	

## SPECIFICATIONS: MSY-D36NA & MUY-D36NA

	Airflow Rate	CFM	1,941	
	Refrigerant Control		LEV	
	Defrost Method		Reverse cycle	
	Heat Exchanger Type		Plate fin coil	
	Sound Pressure Level, Cooling <sup>1</sup>	dB(A)	56	
	Compressor Type		DC INVERTER-driven	
	Compressor Model		TNB220FMCHT	
	Compressor Rated Load Amps	A	16	
	Compressor Locked Rotor Amps	A	20	
	Compressor Oil Type // Charge	oz.	NEO22 // 29.4	
	External Finish Color		Munsell 3Y 7.8/1.1	
	Base Pan Heater		N/A	
	Unit Dimensions	W: In. (mm)		33-1/16 (840)
		D: In. (mm)		13 (330)
		H: In. (mm)		33-7/16 (850)
	Package Dimensions	W: In. (mm)		39 (990)
		D: In. (mm)		18 1/2 (470)
H: In. (mm)			39 3/4 (1,010)	
Unit Weight	Lbs. (kg)		126 (57)	
Package Weight	Lbs. (kg)		152 (69)	
Outdoor Unit Operating Temperature Range	Cooling Air Temp (Maximum / Minimum)*	°F	115 / 14	
	Cooling Thermal Lock-out / Re-start Temperatures**	°F	-4 / 0	
Refrigerant	Type		R410A	
	Charge	Lbs, oz	4	
Piping	Gas Pipe Size O.D. (Flared)	In. (mm)	5/8 (15.88)	
	Liquid Pipe Size O.D. (Flared)	In. (mm)	3/8 (9.52)	
	Maximum Piping Length	Ft. (m)	100 (30)	
	Maximum Height Difference	Ft. (m)	50 (15)	
	Maximum Number of Bends		10	

AHRI Rated Conditions (Rated data is determined at a fixed compressor speed)	<sup>1</sup> Cooling (Indoor // Outdoor)	°F	80 DB, 67 WB // 95 DB, 75 WB
---	--	----	------------------------------

**Notes**  
 \*Applications should be restricted to comfort cooling only; equipment cooling applications are not recommended for low ambient temperature conditions.  
 \*\*System cuts out in heating mode to avoid thermistor error and automatically restarts at these temperatures.

## ACCESSORIES: MSY-D36NA

Deodorizing Filter	□ MAC-1415FT-E
Backlit, Wall-mounted, Wireless Controller	□ MHK1
Portable Central Controller	□ MCCH1
Wired MA Controller	□ PAR-33MAA <sup>1</sup>
Simple MA Controller	□ PAC-YT53CRAU <sup>1</sup>
Touch MA Controller	□ PAR-CT01MAU-SB <sup>1</sup>
Wired Remote Sensor	□ PAC-SE41TS-E
Lockdown Bracket for Wireless, Hand-held, Remote Controller	□ RCMKP1CB
Wireless Temperature and Humidity Sensor	□ PAC-USWHS003-TH-1
Outside Air Sensor for MHK1	□ MOS1
System Control Interface	□ MAC-333IF-E <sup>2</sup>
Wireless Interface	□ PAC-USWHS002-WF-1
Thermostat Interface	□ PAC-US444CN-1
kumo station <sup>®</sup>	□ PAC-WHS01HC-E
USNAP Interface	□ PAC-WHS01UP-E
IT Extender	□ PAC-WHS01IE-E
BACnet <sup>®</sup> and Modbus Interface	□ PAC-UKPRC001-CN-1
Blue Diamond Sensor Extension Cable—15 Ft.	□ C13-103
Blue Diamond Alarm Extension Cable—6.5 Ft.	□ C13-192
Blue Diamond MultiTank—collection tank for use with multiple pumps	□ C21-014
Blue Diamond Rubber Foot Pads	□ F10-010
Mini Condensate Pump—230V application	□ SI30-230
MegaBlue Advanced Blue Diamond Condensate Pump w/ Reservoir & Sensor	□ X87-835 - 110 to 250V
MaxiBlue Advanced Blue Diamond Mini Condensate Pump w/ Reservoir & Sensor (110V) up to 48,000 Btu/h [recommended]	□ X87-711 - 110V
MaxiBlue Advanced Blue Diamond Mini Condensate Pump w/ Reservoir & Sensor (208/230V) up to 48,000 Btu/h [recommended]	□ X87-721 - 208/230V
MicroBlue Blue Diamond Mini Condensate Pump (110/208/230V) up to 18,000 Btu/h	□ X85-003
Fascia Kit for MicroBlue Pump – mounts the MicroBlue and sensor directly beneath the indoor unit	□ T18-016
Drain Pan Level Sensor (Control for indoor unit shut off to prevent drain pan overflow)	□ DPLS2
3 Pole Disconnect Switch (30A/600VUL) [fits 2"X4" utility] - Black	□ TAZ-MS303
3 Pole Disconnect Switch (30A/600VUL) [fits 2"X4" utility] - White	□ TAZ-MS303W
3/8" x 5/8" x 10' / 1/2" Lineset (Twin-Tube Insulation)	□ MPLS385812T-10
3/8" x 5/8" x 15' / 1/2" Lineset (Twin-Tube Insulation)	□ MPLS385812T-15
3/8" x 5/8" x 30' / 1/2" Lineset (Twin-Tube Insulation)	□ MPLS385812T-30
3/8" x 5/8" x 50' / 1/2" Lineset (Twin-Tube Insulation)	□ MPLS385812T-50
3/8" x 5/8" x 65' / 1/2" Lineset (Twin-Tube Insulation)	□ MPLS385812T-65
3/8" x 5/8" x 100' / 1/2" Lineset (Twin-Tube Insulation)	□ MPLS385812T-100

<sup>1</sup> Requires MAC-333IF-E

<sup>2</sup> Allows M-Series indoor units to connect to an MA controller

## ACCESSORIES: MUY-D36NA

Drain Socket	□ MAC-811DS
Outdoor Unit 3-1/4 inch Mounting Base (Pair) - Plastic	□ DSD-400P
Condensing Unit Mounting Pad 16" x 36" x 3"	□ ULTRILITE1
Outdoor Unit Stand—12" High	□ QSMS1201M
Outdoor Unit Stand—18" High	□ QSMS1801M
Outdoor Unit Stand—24" High	□ QSMS2401M
Heavy Duty Wall Mounting Bracket for Outdoor Units—Coated Steel	□ QSWB2000M-1
Heavy Duty Wall Mounting Bracket for Outdoor Units—316 Series Stainless Steel	□ QSWBSS



# DIMENSIONS: MUY-D36NA

**Unit: inch**

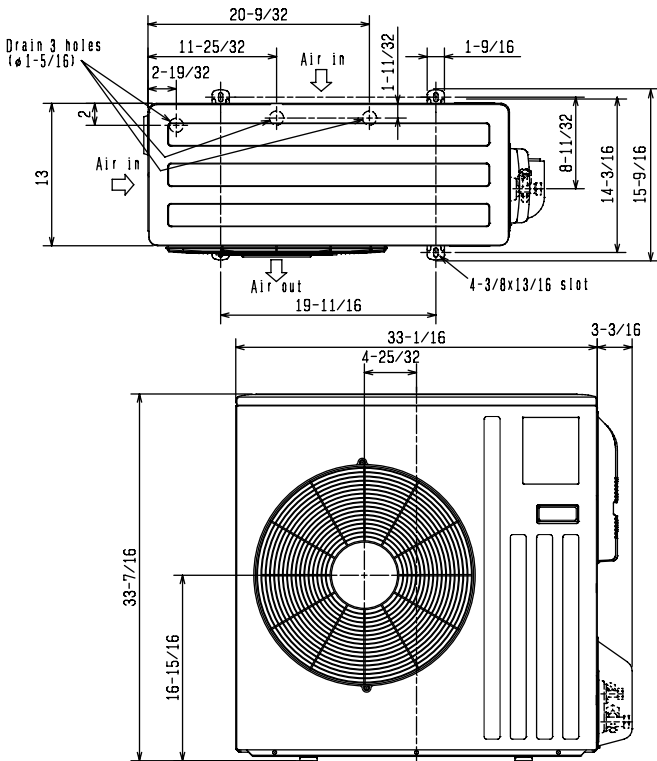

**REQUIRED SPACE**

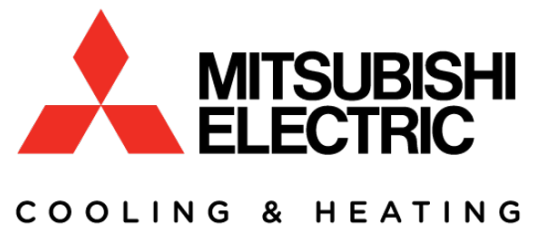
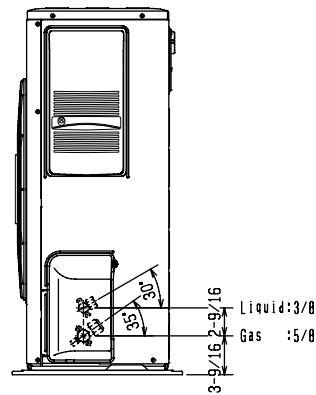
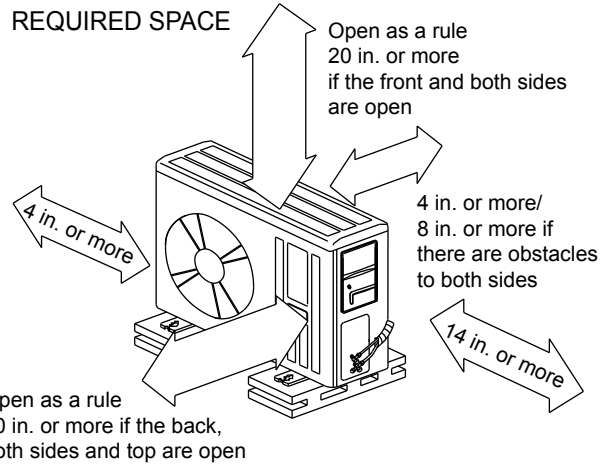

1340 Satellite Boulevard, Suwanee, GA 30024  
 Toll Free: 800-433-4822 www.mehvac.com



FORM# MSY-D36NA / MUY-D36NA - 201808Ver2

Specifications are subject to change without notice.

© 2018 Mitsubishi Electric Trane HVAC US LLC. All rights reserved.