

SPLIT-TYPE AIR CONDITIONERS

Revision A:

- OUTLINES AND DIMENSIONS has been corrected.
- Some descriptions have been modified.

Please void OBH568.

INDOOR UNIT

No. OBH568
REVISED EDITION-A

SERVICE MANUAL

Models

MFZ-KA09NA
MFZ-KA12NA
MFZ-KA18NA

Outdoor unit service manual
MXZ-B·NA Series (OBH560)

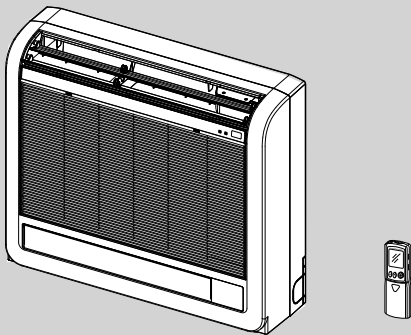

MFZ-KA09NA
MFZ-KA12NA
MFZ-KA18NA

CONTENTS

1. TECHNICAL CHANGES.....	2
2. PART NAMES AND FUNCTIONS.....	2
3. SPECIFICATION.....	4
4. OUTLINES AND DIMENSIONS	5
5. WIRING DIAGRAM.....	6
6. REFRIGERANT SYSTEM DIAGRAM	7
7. SERVICE FUNCTIONS	8
8. MICROPROCESSOR CONTROL	10
9. TROUBLESHOOTING.....	16
10. DISASSEMBLY INSTRUCTIONS.....	30

PARTS CATALOG (OBB568)

NOTE:

RoHS compliant products have <G> mark on the spec name plate.



Revision A:

- OUTLINES AND DIMENSIONS has been corrected.
- Some descriptions have been modified.

1 TECHNICAL CHANGES

MFZ-KA09NA MFZ-KA12NA MFZ-KA18NA

1. New model

2 PART NAMES AND FUNCTIONS

MFZ-KA09NA MFZ-KA12NA MFZ-KA18NA

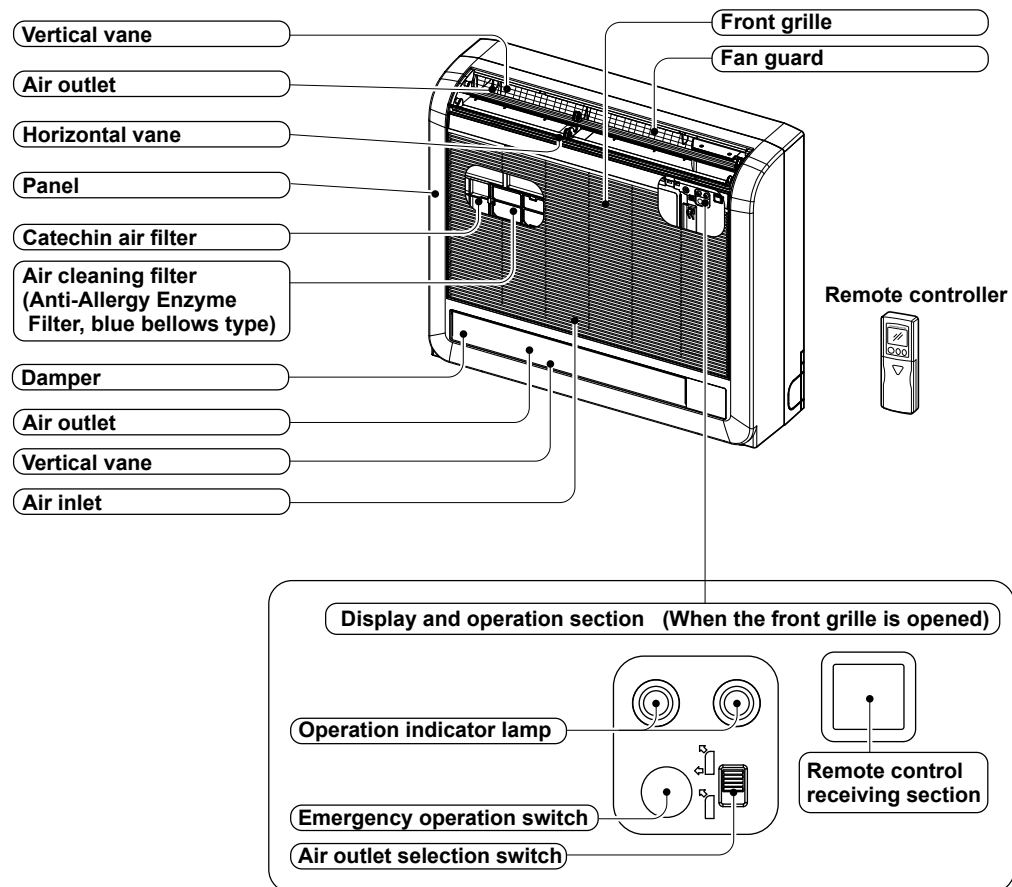

ACCESSORIES

		MFZ-KA09NA MFZ-KA12NA MFZ-KA18NA
①	Drain hose	1
②	Remote controller holder	1
③	Fixing screw for ② 3.5 x 1.6 mm (Black)	2
④	Pipe cover	1
⑤	Band	2
⑥	Battery (AAA) for remote controller	2
⑦	Indoor unit mounting bracket	1
⑧	Fixing screw for ⑦ 4 x 25 mm	5
⑨	Wood screw for the indoor unit fixation	4
⑩	Washer of ⑨	4
⑪	Felt tape (Used for left or left-rear piping)	1
⑫	Wireless remote controller	1
⑬	Air cleaning filter	1

MFZ-KA09NA MFZ-KA12NA MFZ-KA18NA

REMOTE CONTROLLER

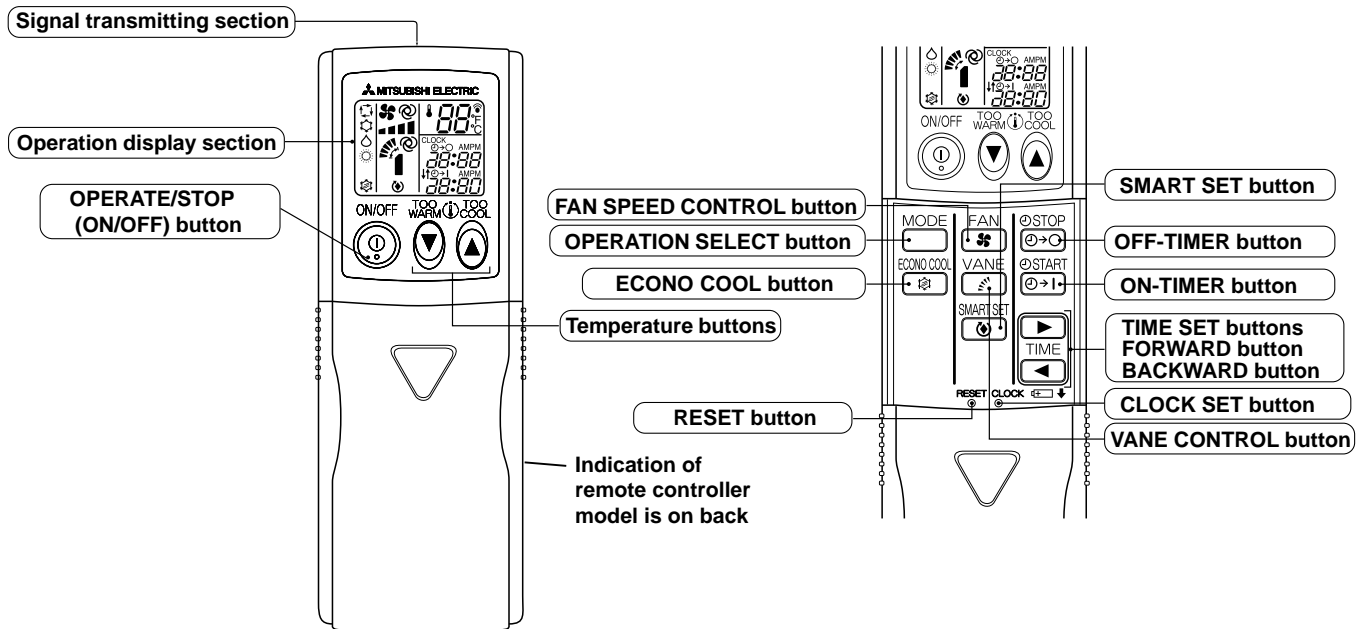

3

SPECIFICATION

Indoor model			MFZ-KA09NA	MFZ-KA12NA	MFZ-KA18NA
Power supply	V, phase, Hz		208/230, 1, 60		
Max. fuse size (time delay)/ Disconnect switch			A 15		
Airflow Super High - High - Med. - Low - Quiet	COOL Dry (Wet)	CFM	314-251-205-169 (303-241-197-163)	321-261-215-177 (309-252-207-170)	394-325-279-251 (379-313-269-241)
	HEAT Dry	CFM	332-219-198-177	335-219-201-184	434-297-275-261
Sound level Super High - High - Med. - Low - Quiet	Cooling	dB(A)	40-35-30-25	41-36-31-26	46-42-38-35
	Heating	dB(A)		41-36-31-28	47-42-38-35
Cond. drain connection O.D.		in.	5/8		
Dimensions	W	in.	27-9/16		
	D		7-7/8		
	H		23-5/8		
Weight		lb.	32		
External finish			White		
Control voltage (by built-in transformer)			12 - 24 VDC		

NOTE: Test conditions are based on ARI 210/240.

3-1. OPERATING RANGE

(1) POWER SUPPLY

	Rated voltage	Guaranteed voltage (V)
Indoor unit	208/230 V 1 phase 60 Hz	

(2) OPERATION

Mode	Condition	Intake air temperature (°F)			
		Indoor		Outdoor	
		DB	WB	DB	WB
Cooling	Standard temperature	80	67	95	—
	Maximum temperature	90	73	115	—
	Minimum temperature	67	57	14	—
	Maximum humidity	78%		—	
Heating	Standard temperature	70	60	47	43
	Maximum temperature	80	67	75	65
	Minimum temperature	70	60	6	5

3-2. OUTLET AIR SPEED AND COVERAGE

Model	Mode	Function	Airflow (CFM)	Air speed (ft./s.)	Coverage (ft.)
MFZ-KA09NA	HEAT	Dry	332	6.6	15.4
	COOL	Dry	314	6.3	14.6
		Wet	303	6.1	14.2
MFZ-KA12NA	HEAT	Dry	335	6.7	15.6
	COOL	Dry	321	6.4	15.0
		Wet	309	6.2	14.5
MFZ-KA18NA	HEAT	Dry	434	8.7	20.0
	COOL	Dry	395	7.9	18.3
		Wet	379	7.5	17.5

• The air coverage is the figure up to the position where the air speed is 1 ft./s., when air is blown out horizontally from the unit properly at the High speed position.

The coverage should be used only as a general guideline since it varies according to the size of the room and furniture arranged inside the room.

4 OUTLINES AND DIMENSIONS

MFZ-KA09NA MFZ-KA12NA MFZ-KA18NA

Unit: inch

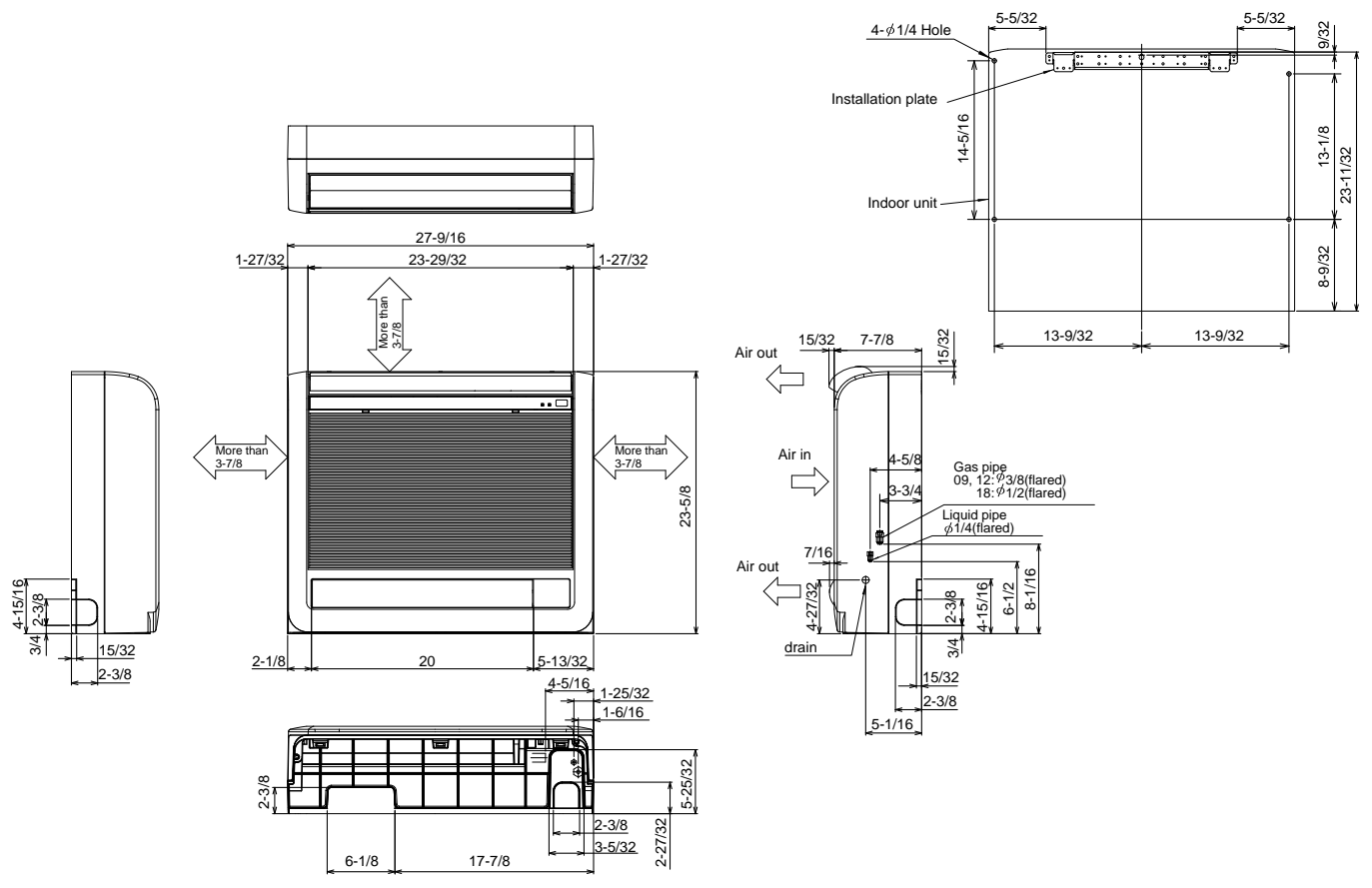

MFZ-KA09NA MFZ-KA12NA MFZ-KA18NA

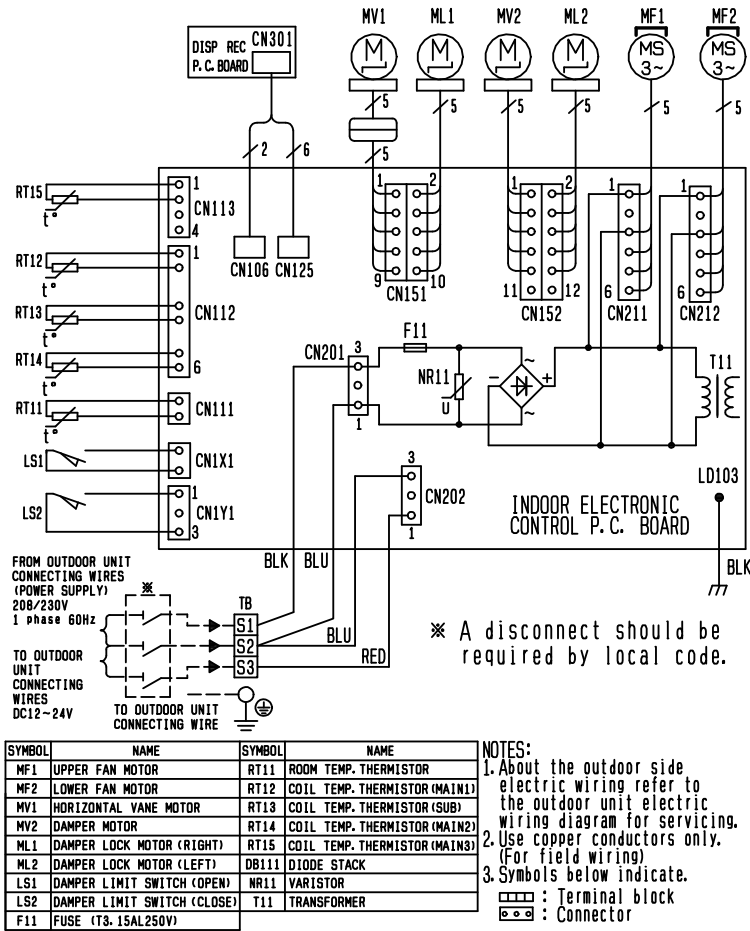

6

REFRIGERANT SYSTEM DIAGRAM

MFZ-KA09NA MFZ-KA12NA MFZ-KA18NA

Unit: inch

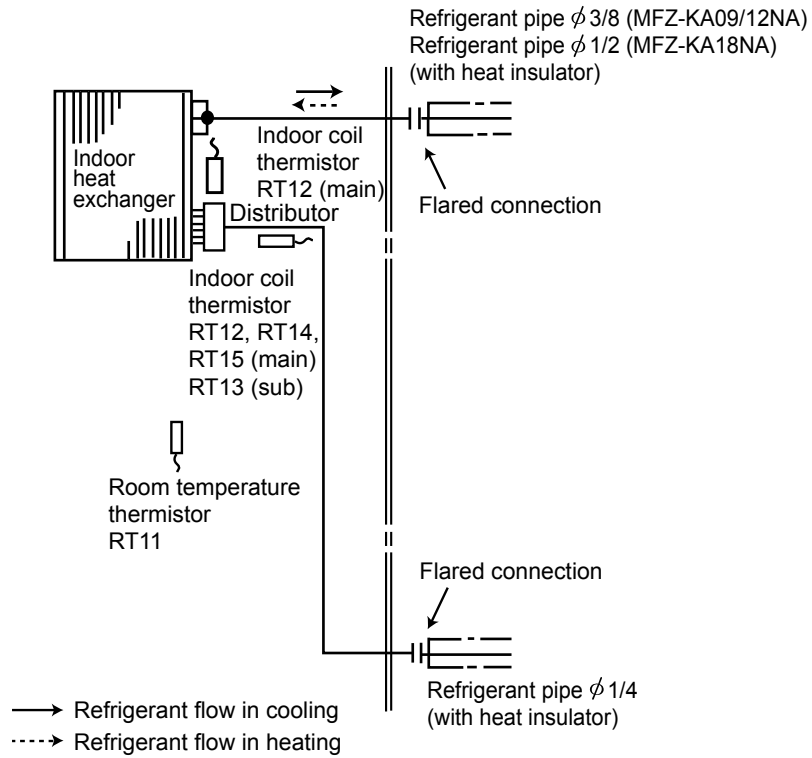

MFZ-KA09NA MFZ-KA12NA MFZ-KA18NA

7-1. TIMER SHORT MODE

For service, the following set time can be shortened by bridging of JPG and JPS on the electronic control P.C. board.
(Refer to 9-7.)

Set time: 3-minutes → 3-seconds (It takes 3 minutes for the compressor to start operation. However, the starting time is shortened by bridging of JPG and JPS.)

7-2. P.C. BOARD MODIFICATION FOR INDIVIDUAL OPERATION

A maximum of 4 indoor units with wireless remote controllers can be used in a room.

In this case, to operate each indoor unit individually by each remote controller, both the P.C. boards of remote controller and the electronic control P.C. boards must be modified according to the number of the indoor unit.

How to modify the remote controller P.C. board

Remove batteries before modification.

The board has a print as shown below :

Remote controller model: KM05G

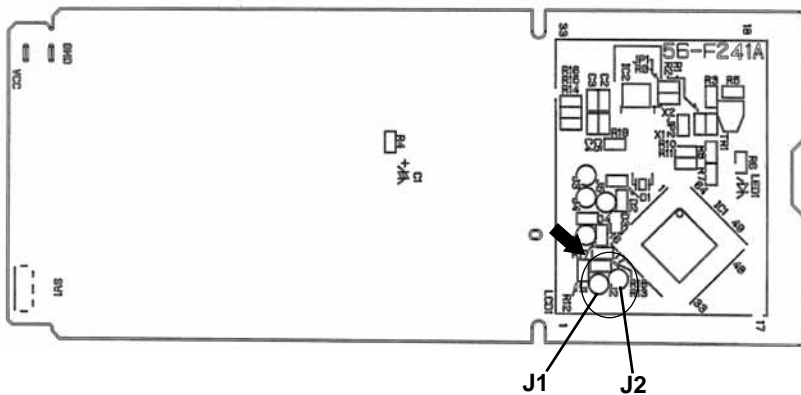

NOTE: For modification, take out the batteries and push the OPERATE/STOP (ON/OFF) button 2 or 3 times at first.

After finish modification, put back the batteries then press the RESET button.

The P.C. board has the print "J1" and "J2". Solder "J1" and "J2" according to the number of indoor unit as shown in Table 1. After modification, press the RESET button.

Table 1

	1 unit operation	2 units operation	3 units operation	4 units operation
No. 1 unit	No modification	Same as at left	Same as at left	Same as at left
No. 2 unit	–	Solder J1	Same as at left	Same as at left
No. 3 unit	–	–	Solder J2	Same as at left
No. 4 unit	–	–	–	Solder both J1 and J2

How to modify the electronic control P.C. board

Turn OFF the power supply before modification. Cut off "JR05" and "JR06" on the electronic control P.C. board according to the number of indoor unit as shown in Table 2. (Refer to 9-7.)

Table 2

	JR05	JR06
No. 1 unit	No modification	No modification
No. 2 unit	Cut off JR05	No modification
No. 3 unit	No modification	Cut off JR06
No. 4 unit	Cut off JR05	Cut off JR06

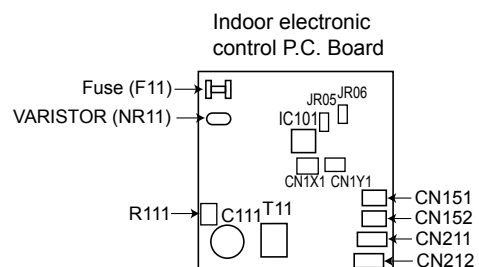

NOTE: After modification, turn ON the power supply and with the remote controller headed towards the indoor unit, press the OPERATE/STOP (ON/OFF) button. If 1 or 2 beeps is heard from the indoor unit, modification is completed correctly.

7-3. AUTO RESTART FUNCTION

When the indoor unit is controlled with the remote controller, the operation mode, the set temperature, and the fan speed are memorized by the indoor electronic control P.C. board. The "AUTO RESTART FUNCTION" sets to work the moment power is restored after power failure. Then, the unit will restart automatically.

Operation

- ① If the main power has been cut, the operation settings remain.
- ② After the power is restored, the unit restarts automatically according to the memory.
(However, it takes at least 3 minutes for the compressor to start running.)

How to release "AUTO RESTART FUNCTION"

- ① Turn off the main power for the unit.
- ② Solder the Jumper wire to JR07 on the indoor electronic control P.C. board. (Refer to 9-7.)

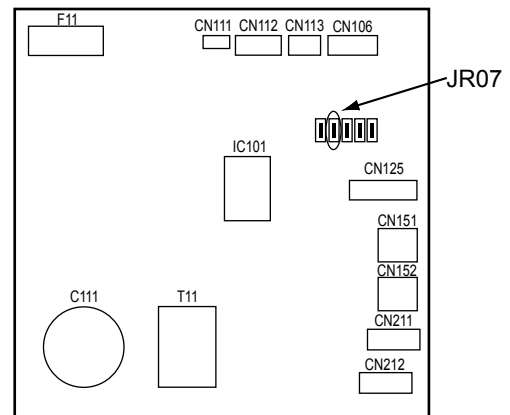

NOTE:

- The operation settings are memorized when 10 seconds have passed after the indoor unit was operated with the remote controller.
- If main power is turned OFF or a power failure occurs while AUTO START/STOP timer is active, the timer setting is cancelled.
- If the unit has been turned OFF with the remote controller before power failure, the auto restart function does not work as the power button of the remote controller is OFF.
- To prevent breaker tripping due to the rush of starting current, systematize other home appliance not to turn ON at the same time.
- When some air conditioners are connected to the same supply system, if they are operated before power failure, the starting current of all the compressors may flow simultaneously at restart. Therefore, the special counter-measures are required to prevent the main voltage-drop or the rush of the starting current by adding to the system that allows the units to start one by one.

MFZ-KA09NA MFZ-KA12NA MFZ-KA18NA

WIRELESS REMOTE CONTROLLER

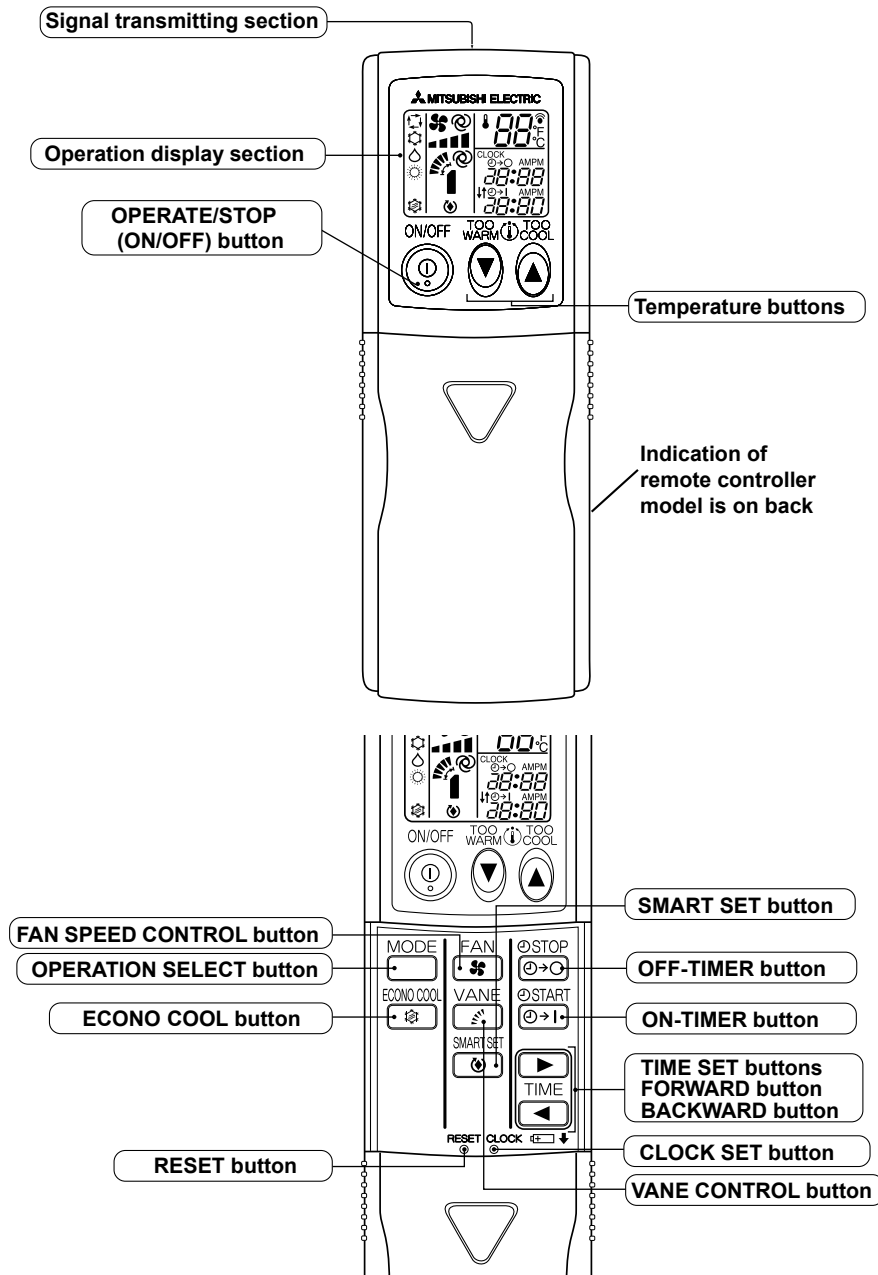

Once the operation mode is set, the same operation mode can be repeated by simply turning OPERATE/STOP (ON/OFF) button ON.

Indoor unit receives the signal with a beep tone.

When the system turns OFF, 3-minute time delay will operate to protect system from overload and compressor will not restart for 3 minutes.

8-1. COOL (❄️) OPERATION

- (1) Press OPERATE/STOP (ON/OFF) button.
OPERATION INDICATOR lamp of the indoor unit turns ON with a beep tone.
- (2) Select COOL mode with OPERATION SELECT button.
- (3) Press TEMPERATURE buttons (TOO WARM or TOO COOL) to select the desired temperature.
The setting range is 61 ~ 88°F (16 ~ 31°C).

1. Coil frost prevention

The compressor operational frequency is controlled by the temperature of the indoor heat exchanger to prevent the coil from frosting.

When the temperature of indoor heat exchanger becomes too low, the coil frost prevention mode works.

The indoor fan operates at the set speed and the compressor stops. This mode continues until the temperature of indoor heat exchanger rises.

2. Low outside temperature operation

When the outside temperature is low, low outside temperature operation starts, and the outdoor fan slows or stops.

8-2. DRY (△) OPERATION

(1) Press OPERATE/STOP (ON/OFF) button.

OPERATION INDICATOR lamp of the indoor unit turns ON with a beep tone.

(2) Select DRY mode with OPERATION SELECT button.

(3) The set temperature is determined from the initial room temperature.

1. Coil frost prevention

Coil frost prevention works the same way as that in COOL mode. (8-1.1.)

The indoor fan maintains the actual speed of the moment.

2. Low outside temperature operation

Low outside temperature operation works the same way as that in COOL mode. (8-1.2.)

NOTE: Even when the damper is closed while cooling or drying operation is performed, the lower fan may rotate intermittently.

8-3. HEAT (☼) OPERATION

(1) Press OPERATE/STOP (ON/OFF) button.

OPERATION INDICATOR lamp of the indoor unit turns ON with a beep tone.

(2) Select HEAT mode with OPERATION SELECT button.

(3) Press TEMPERATURE buttons (TOO WARM or TOO COOL button) to select the desired temperature.

The setting range is 61 ~ 88°F (16 ~ 31°C).

1. Cold air prevention control

When the compressor is not operating or is starting, and the temperature of indoor heat exchanger and/or the room temperature is low or when defrosting is being done, the indoor fan will stop or rotate in Very Low speed.

2. High pressure protection

The compressor operational frequency is controlled by the temperature of the indoor heat exchanger to prevent the condensing pressure from increasing excessively.

When the temperature of indoor heat exchanger becomes too high, the high pressure protection works.

The indoor fan operates following the cold air prevention control. This mode continues until the temperature of indoor heat exchanger falls.

3. Defrosting

Defrosting starts when the temperature of outdoor heat exchanger becomes too low.

The compressor stops once, the indoor/outdoor fans stop, the 4-way valve reverses and the compressor re-starts.

This mode continues until the temperature of outdoor heat exchanger rises or the fixed time passes.

8-4. AUTO CHANGE OVER ... AUTO MODE OPERATION

Once desired temperature is set, unit operation is switched automatically between COOL and HEAT operation.

Mode selection

(1) Initial mode

When unit starts the operation with AUTO operation from OFF:

- If the room temperature is higher than the set temperature, operation starts in COOL mode.
- If the room temperature is equal to or lower than the set temperature, operation starts in HEAT mode.

(2) Mode change

COOL mode changes to HEAT mode when about 15 minutes have passed with the room temperature 2°F (1°C) below the set temperature.

HEAT mode changes to COOL mode when about 15 minutes have passed with the room temperature 2°F (1°C) above the set temperature.

NOTE1: Mode selection is performed when multi standby (refer to **NOTE2**) is released and the unit starts operation with ON-timer.

NOTE2: If two or more indoor units are operating in multi system, there might be a case that the indoor unit, which is operating in AUTO (□), cannot change over to the other operating mode (COOL ↔ HEAT) and becomes a state of standby.

8-5. AUTO VANE OPERATION

Horizontal vane

(1) Vane motor drive

These models are equipped with a stepping motor for the horizontal vane. The rotating direction, speed, and angle of the motor are controlled by pulse signals (approximately 12 V) transmitted from indoor microprocessor.

(2) The horizontal vane angle and mode change as follows by pressing VANE CONTROL button.

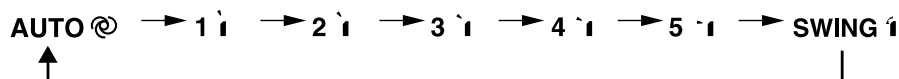

(3) Positioning

The vane presses the vane stopper once to confirm the standard position and then moves to the set angle. Confirming of standard position is performed in case of follows.

- When the power supply turns ON.
- When the operation starts or finishes (including timer operation).
- When the test run starts.
- When multi-standby starts or finishes.
- When the swing operation finishes.

(4) VANE AUTO (@) mode

The microprocessor automatically determines the vane angle and operation to make the optimum room temperature distribution.

COOL and DRY operation

Vane angle is fixed to Angle 1.



HEAT operation

When the upper air outlet is selected with an air outlet selection switch, vane angle is fixed to Angle 5.

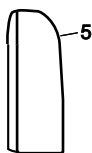

When the upper and lower air outlets are selected with an air outlet selection switch, vane angle is fixed to Angle 3.



(5) STOP (operation OFF) and ON-TIMER standby

When the following cases occur, the horizontal vane returns to the closed position.

- When OPERATE/STOP (ON/OFF) button is pressed (POWER OFF).
- When the operation is stopped by the emergency operation.
- When ON-TIMER is ON standby.

(6) Dew prevention

During COOL or DRY operation with the vane angle at Angle 3 ~ 5 when the compressor cumulative operation time exceeds 30 minutes to 1 hour, the vane angle automatically changes to Angle 1 for dew prevention.

(7) SWING MODE ()

By selecting SWING mode with VANE CONTROL button, the horizontal vane swings vertically. The remote controller displays " ". SWING mode is cancelled when VANE CONTROL button is pressed once again.

(8) Cold air prevention in HEAT operation

The vane angle changes to Horizontal position automatically to prevent cold air blowing on users.

(9) Damper operation

NOTE 1: Be sure to turn OFF the air conditioner before changing the switch setting.

With this function, air comes out simultaneously from the upper and lower air outlets so that the room can be cooled or heated effectively. This function is set using the switch behind the front grille of the indoor unit. (This function is available in cooling and heating operation.)

1.How to set to blow out air from the upper and lower air outlets:

Set the air outlet selection switch to

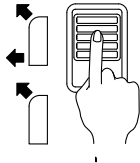

2.How to set to blow out air from the upper air outlet only:

Set the air outlet selection switch to

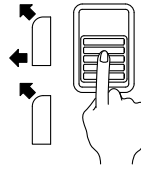

Air blows out automatically from the upper and lower air outlets as shown in the table below.

NOTE 2: Set the air outlet selection switch to the end correctly. Otherwise, air outlet cannot be selected as intended.

Description of operation

The direction (opening and closing of the damper) and the volume of the airflow from the lower air outlet are controlled automatically.

Operation	COOL		DRY	HEAT	
Air flow					
Conditions	Room temperature and set temperature are different.	Room temperature is close to set temperature, or the air conditioner has operated for 1 hour.	—	Air flow temperature is high.	Air flow temperature is low. (During defrosting operation, start of operation, etc.)

- Be sure to keep the area around the damper of the lower air outlet free of any objects. If any objects block the normal operation of the damper, the left operation indicator lamp may blink.

(10) EMBEDDING THE INDOOR UNIT IN A WALL

- When installing a grating, use a grating with narrow upper and lower horizontal bars so that the airflow from the upper and lower air outlets does not contact the bars. If the horizontal bars will block the lower air outlet, use a stand, etc., to adjust the height of the indoor unit. If the upper or lower air outlet is blocked, the air conditioner will not be able to cool or warm the room well.
- Do not block the receiver with the grating. Otherwise, the grating will interfere with the remote controller signal and significantly reduce the distance and area (angle) from which the signals can be received.

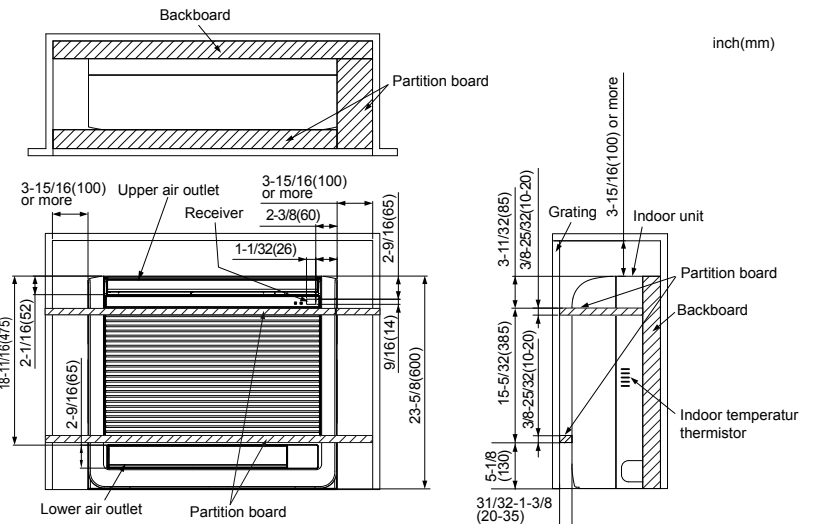

- Use a grating with vertical bars, etc., that has at least 75 % open area. If the grating has horizontal bars or if the open area is less than 75%, performance could be reduced.
- When the indoor unit is embedded in a wall (built-in), the time it takes for the room temperature to reach the set temperature will increase

EMBEDDED INDOOR UNIT SETTING

(MUST BE PERFORMED)

- When embedding the indoor unit in a wall, restrict the movement of the horizontal vane for the upper air outlet so that it only operates horizontally.
- If this setting is not performed, heat will build up in the wall and the room will not be cooled or warmed properly.
- Cut the wires on the left and right sides of JRFBL using a pair of nippers, etc., as shown here.

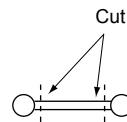

Cut the wires on both ends.

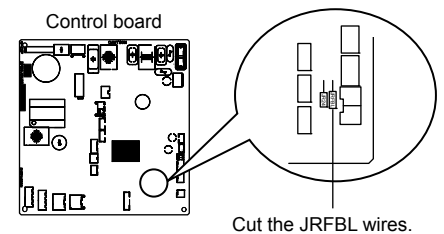

Cut the JRFBL wires.

(11) ECONO COOL () operation (ECONOMical operation)

When ECONO COOL button is pressed in COOL mode, set temperature is automatically set 4°F (2°C) higher.

Also the horizontal vane swings in various cycle according to the temperature of indoor heat exchanger (indoor coil thermostat).

SWING operation makes you feel cooler than set temperature. So, even though the set temperature is higher, the air conditioner can keep comfort. As a result, energy can be saved.

ECONO COOL operation is cancelled when ECONO COOL button is pressed once again or VANE CONTROL button is pressed or change to other operation mode.

8-6. TIMER OPERATION

1. How to set the time



(1) Check that the current time is set correctly.

NOTE: Timer operation will not work without setting the current time. Initially "0:00 AM" blinks at the current time display of TIME MONITOR, so set the current time correctly with CLOCK SET button.

How to set the current time

(a) Press the CLOCK set button.

(b) Press the TIME SET buttons ( and ) to set the current time.

• Each time FORWARD button () is pressed, the set time increases by 1 minute, and each time BACKWARD button () is pressed, the set time decreases by 1 minute.

• Pressing those buttons longer, the set time increases/decreases by 10 minutes.



(c) Press the CLOCK set button.

(2) Press OPERATE/STOP (ON/OFF) button to start the air conditioner.

(3) Set the time of timer.



ON timer setting



(a) Press ON TIMER button () during operation.

(b) Set the time of the timer using TIME SET buttons ( and ). ※

OFF timer setting

(a) Press OFF TIMER button () during operation.

(b) Set the time of the timer using TIME SET buttons ( and ). ※

※ Each time FORWARD button () is pressed, the set time increases by 10 minutes: each time BACKWARD button () is pressed, the set time decreases by 10 minutes.

2. To release the timer

To release ON timer, press ON TIMER button ().

To release OFF timer, press OFF TIMER button ().

TIMER is cancelled and the display of set time disappears.

PROGRAM TIMER

• OFF timer and ON timer can be used in combination. The set time that is reached first will operate first.

• "↓" and "↑" display shows the order of OFF timer and ON timer operation.

(Example 1) The current time is 8:00 PM.

The unit turns OFF at 11:00 PM, and ON at 6:00 AM.

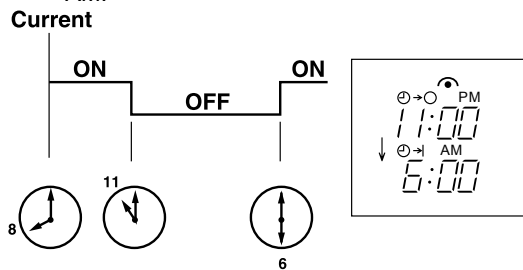

(Example 2) The current time is 11:00 AM.

The unit turns ON at 5:00 PM, and OFF at 9:00 PM.

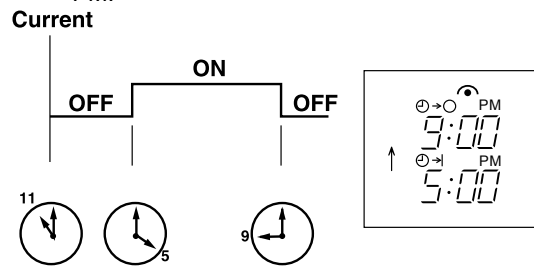

NOTE: If the main power is turned OFF or a power failure occurs while ON/OFF timer is active, the timer setting is cancelled. As these models are equipped with an auto restart function, the air conditioner starts operating with timer cancelled when power is restored.

8-7. SMART SET (☺) OPERATION

1. How to SET SMART SET operation

- (1) Press OPERATE/STOP (ON/OFF) button.
- (2) Select COOL, HEAT or ECONO COOL mode.
- (3) Press SMART SET button.
- (4) Set the temperature, fan speed, and airflow direction for SMART SET operation.

NOTE: • SMART SET operation cannot be selected during DRY or AUTO mode operation.

- The setting range of HEAT mode in SMART SET operation is 50°F (10°C) and 61 - 88°F (16 - 31°C).
- 2 settings can be saved. (One for COOL/ECONO COOL, one for HEAT)

2. How to cancel operation

- Press SMART SET button again.
- SMART SET operation can also be cancelled by pressing OPERATION SELECT button to change the operation mode. The same setting is selected from the next time by simply pressing SMART SET button.

8-8. EMERGENCY/TEST OPERATION

In the case of test run operation or emergency operation, use EMERGENCY OPERATION switch on the right side of the indoor unit. Emergency operation is available when the remote controller is missing or has failed, or when the batteries of the remote controller are running down. The unit will start and OPERATION INDICATOR lamp will light up.

The first 30 minutes of operation is the test run operation. This operation is for servicing. The indoor fan runs at High speed and the temperature control does not work.

After 30 minutes of test run operation, the system shifts to EMERGENCY COOL/HEAT MODE with a set temperature of 75°F (24°C). The fan speed shifts to Med.

The coil frost prevention works even in the test run or the emergency operation.

In the test run or emergency operation, the horizontal vane operates in VANE AUTO (@) mode.

Emergency operation continues until EMERGENCY OPERATION switch is pressed once/ twice or the unit receives any signal from the remote controller. In the latter case, normal operation will start.

NOTE: Do not press EMERGENCY OPERATION switch during normal operation.



Operation mode	COOL	HEAT
Set temperature	24°C	24°C
Fan speed	Med.	Med.
Horizontal vane	Auto	Auto

- The following indication does not depend on the shape of lamp.

OPERATION INDICATOR lamp

- | | | | |
|-------------------------|---|---|---------------|
| Press once <Cool> | ☀ | ☐ | ☀ Lighted |
| Press again <Heat> | ☐ | ☀ | ☐ Not lighted |
| Press once again <Stop> | ☐ | ☐ | |

8-9. Changing temperature indication (°F/°C)

- The preset unit is °F.
- °F → °C: Press RESET button while the temperature buttons are pressed.
- °C → °F: Press RESET button or remove the batteries .

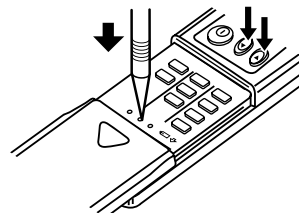

Press RESET button gently using a thin instrument.

MFZ-KA09NA MFZ-KA12NA MFZ-KA18NA

9-1. CAUTIONS ON TROUBLESHOOTING

1. Before troubleshooting, check the following

- 1) Check the power supply voltage.
- 2) Check the indoor/outdoor connecting wire for miswiring.

2. Take care of the following during servicing

- 1) Before servicing the air conditioner, be sure to turn OFF the unit first with the remote controller, and then after confirming the horizontal vane is closed, turn OFF the breaker and/or disconnect the power plug.
- 2) Be sure to turn OFF the power supply before removing the front panel, the cabinet, the top panel, and the P.C. board.
- 3) When removing the P.C. board, hold the edge of the board with care NOT to apply stress on the components.
- 4) When connecting or disconnecting the connectors, hold the connector housing. DO NOT pull the lead wires.

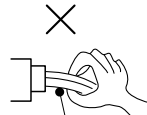

Lead wiring

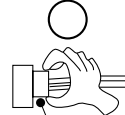

Connector housing

3. Troubleshooting procedure

- 1) Check if the OPERATION INDICATOR lamp on the indoor unit is flashing ON and OFF to indicate an abnormality. To make sure, check how many times the abnormality indication is flashing ON and OFF before starting service work.
- 2) Before servicing check that the connector and terminal are connected properly.
- 3) When the P.C. board seems to be defective, check the copper foil pattern for disconnection and the components for bursting and discoloration.
- 4) When troubleshooting, refer to 9-2, 9-3 and 9-4.

4. How to replace batteries

Weak batteries may cause the remote controller malfunction.

In this case, replace the batteries to operate the remote controller normally.

- ① Remove the front lid and insert batteries. Then reattach the front lid.

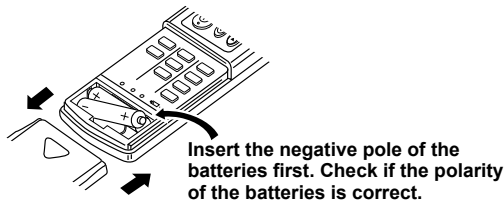

- ② Press RESET button with a thin instrument, and then use the remote controller.

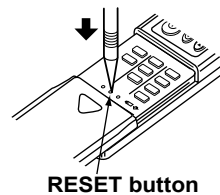

NOTE: 1. If RESET button is not pressed, the remote controller may not operate correctly.

2. This remote controller has a circuit to automatically reset the microcomputer when batteries are replaced. This function is equipped to prevent the microcomputer from malfunctioning due to the voltage drop caused by the battery replacement.

3. Do not use the leaking batteries.

INFORMATION FOR MULTI SYSTEM AIR CONDITIONER

OUTDOOR UNIT: MXZ series

Multi system air conditioner can connect two or more indoor units with one outdoor unit.

- Unit won't operate in case the total capacity of indoor units exceeds the capacity of outdoor units.

Do not connect indoor units beyond the outdoor unit capacity.

Operation indicator lamp flashes as shown in the figure below.

- When you try to operate two or more indoor units with one outdoor unit simultaneously, one for the cooling and the other for heating, the operation mode of the indoor unit that operates earlier is selected. The other indoor units will start the operation later cannot operate, indicating as shown in the figure below. In this case, please set all the indoor units to the same operation mode.

OPERATION INDICATOR

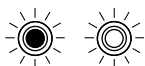

 Lighted (Green)

 Blinking (Green or Orange)

 Blinking green : Standby for normal operation
 Blinking orange : Standby for i-save operation

 Not lighted

- When indoor units start operation while the defrosting of outdoor unit is being done, it takes a few minutes (max. 10 minutes) to blow out the warm air.

- In heating operation, even though the indoor unit is not in operation, the room may get warm or the sound of refrigerant flowing may be heard. This is not a malfunction. The refrigerant continuously flowing into it causes this.

9-2. FAILURE MODE RECALL FUNCTION

Outline of the function

This air conditioner can memorize the abnormal condition which has occurred once.

Even though OPERATION INDICATOR lamp indication listed on the troubleshooting check table (9-4.) disappears, the memorized failure details can be recalled.

This mode is very useful when the unit needs to be repaired for the abnormality which does not recur.

1. Flow chart of failure mode recall function for the indoor/outdoor unit

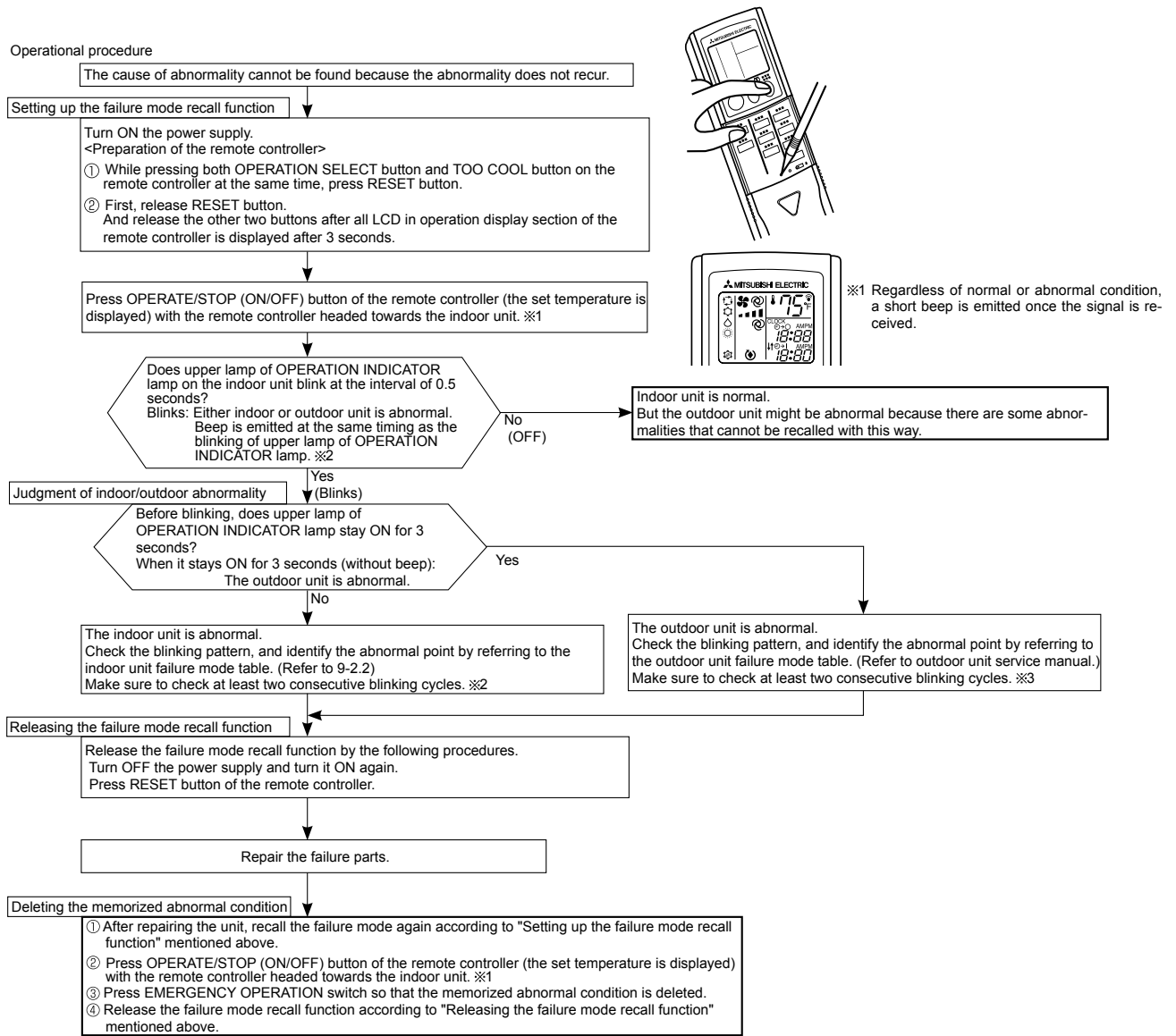

NOTE: 1. Make sure to release the failure mode recall function after it is set up, otherwise the unit cannot operate properly.
2. If the abnormal condition is not deleted from the memory, the last abnormal condition is kept memorized.

※2. Blinking pattern when the indoor unit is abnormal:

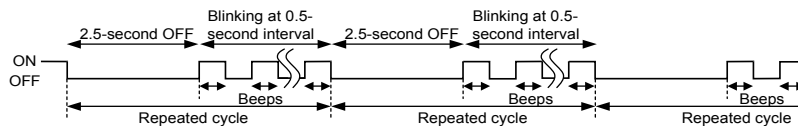

※3. Blinking pattern when the outdoor unit is abnormal:

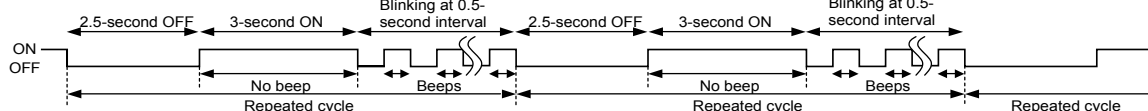

2. Indoor unit failure mode table

NOTE: Blinking patterns of this mode differs from the ones of Troubleshooting check table (9-4.).

Left lamp of OPERATION INDICATOR lamp	Right lamp of OPERATION INDICATOR lamp	Abnormal point (Failure mode)	Check point	Countermeasure
Not lighted	Not lighted	Normal	–	–
1-time flash every 0.5-second	Not lighted	Room temperature thermistor	When the room temperature thermistor short or open circuit is detected every 8 seconds during operation.	Refer to the characteristics of the room temperature thermistor (9-7.).
2-time flash 2.5-second OFF	Not lighted	Indoor coil thermistor (Main 1, 2 and sub)	When the indoor coil thermistor short or open circuit is detected every 8 seconds during operation.	Refer to the characteristic of the main 1,2 indoor coil thermistor and the sub indoor coil thermistor (9-7.).
3-time flash 2.5-second OFF	Not lighted	Serial signal error	When the serial signal from the outdoor unit is not received for a maximum of 6 minutes.	Refer to 9-6.Ⓒ "How to check miswiring and serial signal error".
11-time flash 2.5-second OFF	Not lighted	Indoor fan motor (Upper)	When the rotational frequency feedback signal is not emitted during 12-second the indoor fan operation.	Refer to 9-6.Ⓐ-1 "Check of indoor fan motor (Upper)"
	1-time flash every 0.5-second	Indoor fan motor (Lower)		Refer to 9-6.Ⓐ-2 "Check of indoor fan motor (Lower)"
12-time flash 2.5-second OFF	Not lighted	Indoor control system	When it cannot be read properly data in the nonvolatile memory of the indoor electronic control P.C. board.	Replace the indoor electronic control P.C. board.
13-time flash 2.5-second OFF	Not lighted	Indoor coil thermistor (Main 3)	When the indoor coil thermistor short or open circuit is detected every 8 seconds during operation.	Replace to the characteristic of the main 3 indoor coil thermistor (9-7.).
14-time flash 2.5-second OFF	Not lighted	Damper	When the damper is not located at the designated position.	Refer to 9-6.Ⓔ "Check of damper".

9-3. INSTRUCTION OF TROUBLESHOOTING

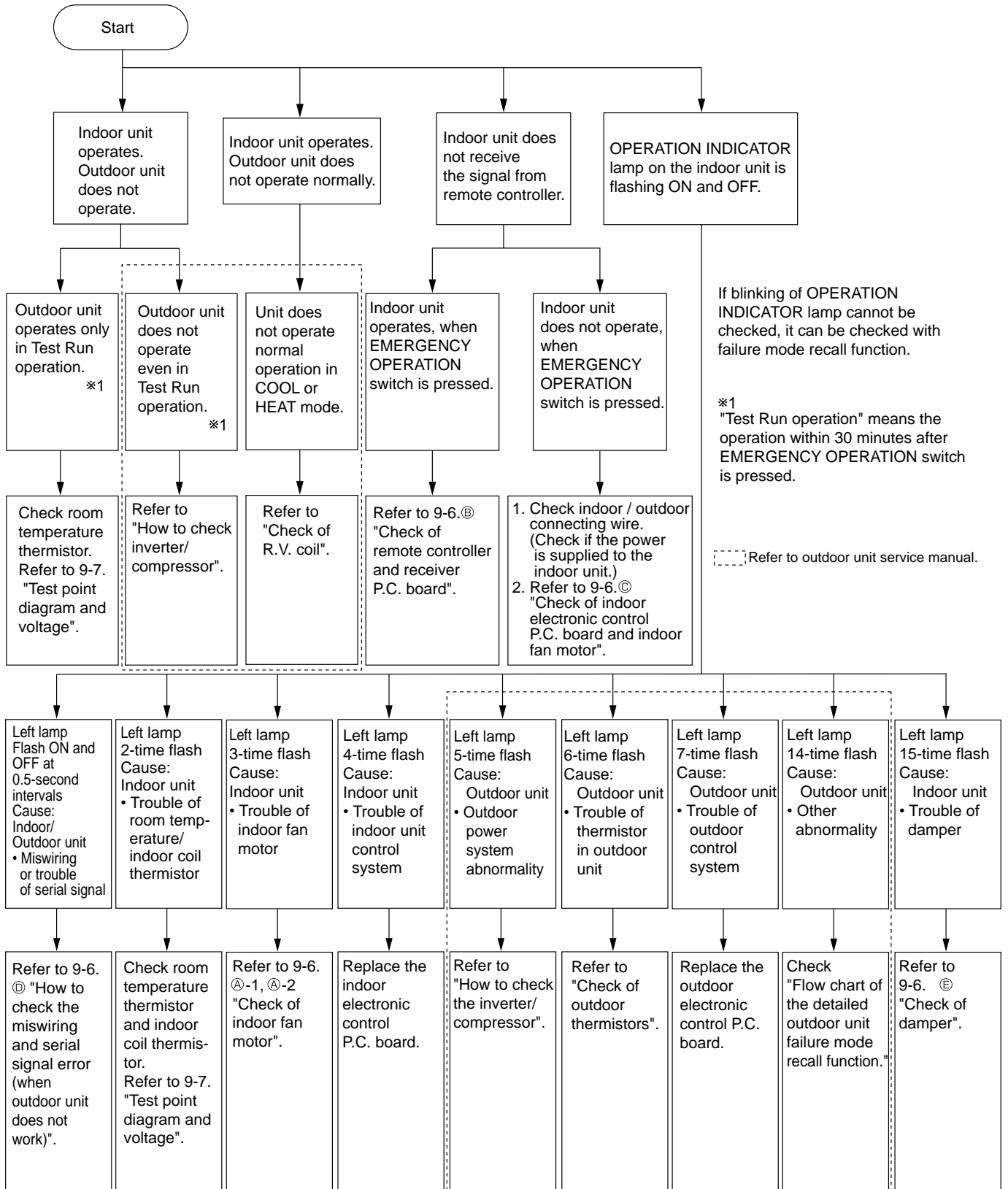

9-4. TROUBLESHOOTING CHECK TABLE

OPERATION INDICATOR



Lighted



Blinking









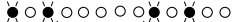

Not lighted

Flashing of OPERATION INDICATOR lamp (left-hand side lamp) indicates abnormalities.

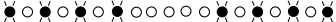
NOTE: Before taking measures, make sure that the symptom reappears for accurate troubleshooting.

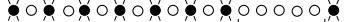
Self check table

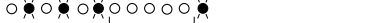
No.	Abnormal point	Operation indicator lamp	Symptom	Check point	Countermeasure
1	Miswiring or serial signal	Left lamp flashes. 0.5-second ON  0.5-second OFF	Indoor unit and outdoor unit do not operate.	When the serial signal from the outdoor unit is not received for a maximum of 6 minutes.	• Refer to 9-6.② "How to check mis-wiring and serial signal error".
2	Outdoor control system	Left lamp lights up 	Outdoor unit does not operate.	When it cannot properly read data in the nonvolatile memory of the outdoor electronic control P.C. board.	• Check the blinking pattern of the LED on the outdoor electronic control P.C. board.
3	Indoor coil thermistor Room temperature thermistor	Left lamp flashes. 2-time flash  2.5-second OFF	Indoor unit and outdoor unit do not operate.	When the indoor coil or the room temperature thermistor is shorts or opens circuit.	• Refer to the characteristics of indoor coil thermistor, and the room temperature thermistor on 9-7.
4	Indoor fan motor	Left lamp flashes. 3-time flash  2.5-second OFF	Indoor unit and outdoor unit do not operate.	When the rotational frequency feedback signal is not emitted during the indoor fan operation.	• Refer to 9-6.④-1, ④-2 "Check of indoor fan motor".
5	Indoor control system	Left lamp flashes. 4-time flash  2.5-second OFF	Indoor unit and outdoor unit do not operate.	When it cannot properly read data in the nonvolatile memory of the indoor electronic control P.C. board.	• Replace the indoor electronic control P.C. board.
6	Outdoor power system	Left lamp flashes. 5-time flash  2.5-second OFF	Indoor unit and outdoor unit do not operate.	The compressor stops 3 times consecutively for over current protection or start-up failure protection within 1 minute after start-up.	• Refer to "Check of inverter/compressor". Refer to outdoor unit service manual. Check the stop valve.
7	Outdoor thermistors	Left lamp flashes. 6-time flash  2.5-second OFF	Indoor unit and outdoor unit do not operate.	When the outdoor thermistors short or open circuit during the compressor operation.	• Refer to "Check of outdoor thermistor". Refer to outdoor unit service manual.
8	Outdoor control system	Left lamp flashes. 7-time flash  2.5-second OFF	Indoor unit and outdoor unit do not operate.	When it cannot properly read data in the nonvolatile memory of the outdoor electronic control P.C. board.	• Replace the outdoor electronic control P.C. board. Refer to outdoor unit service manual.
9	Other abnormality	Left lamp flashes. 14-time flash  2.5-second OFF	Indoor unit and outdoor unit do not operate.	An abnormality other than above mentioned is detected.	• Check the abnormality in detail using the failure mode recall function. Refer to outdoor unit service manual.
10	Indoor damper	Left lamp flashes. 15-time flash  2.5-second OFF	Indoor unit and outdoor unit do not operate.	When the damper is not located at the designated position.	• Refer to 9-6.⑥ "Check of damper".

NOTE: When the indoor unit has started operation and the above failures are detected (the first detection after the power ON), the indoor electronic control P.C. board turns OFF the indoor fan motor with OPERATION INDICATOR lamp flashing.

OPERATION INDICATOR



Lighted



Blinking



Not lighted

- Flashing of OPERATION INDICATOR lamp (right-hand side lamp) indicates abnormality.
- OPERATION INDICATOR lamp (left-hand side lamp) is lighted.

No.	Abnormal point	Operation indicator lamp	Symptom	Check point	Countermeasure
1	MXZ type Operation mode setting		Outdoor unit operates but indoor unit does not operate.	When the operation mode of the each indoor unit is differently set to COOL (includes DRY) and HEAT at the same time, the operation mode of the indoor unit that has operated at first has the priority.	<ul style="list-style-type: none"> · Unify the operation mode. Refer to outdoor unit service manual.

NOTE: When the indoor unit has started operation and the above failures are detected (the first detection after the power ON), the indoor electronic control P.C. board turns OFF the indoor fan motor with OPERATION INDICATOR lamp flashing.

9-5. TROUBLE JUDGEMENT CRITERIA OF MAIN PARTS

MFZ-KA09NA MFZ-KA12NA MFZ-KA18NA

Part name	Check method and criteria	Figure					
Room temperature thermistor (RT11)	Measure the resistance with a tester. (Part temperature: 10°C ~ 30°C)						
Indoor coil thermistor (RT12 (MAIN1), RT13 (SUB) RT14 (MAIN2), RT15 (MAIN3))	<table border="1"> <tr> <td>Normal</td> </tr> <tr> <td>8 kΩ ~ 20 kΩ</td> </tr> </table>		Normal	8 kΩ ~ 20 kΩ			
Normal							
8 kΩ ~ 20 kΩ							
Indoor fan motor (Upper) (MF1)	Check 9-6.Ⓐ -1.						
Indoor fan motor (Lower) (MF2)	Check 9-6.Ⓐ -2.						
Damper lock motor Right (ML1)	Measure the resistance between the terminals with a tester. (Part temperature: 10°C ~ 30°C)						
	<table border="1"> <tr> <td>Color of the lead wire</td> <td>Normal</td> </tr> <tr> <td>BRN-other one</td> <td>235 Ω ~ 255 Ω</td> </tr> </table>		Color of the lead wire	Normal	BRN-other one	235 Ω ~ 255 Ω	
Color of the lead wire	Normal						
BRN-other one	235 Ω ~ 255 Ω						
Damper lock motor Left (ML2)	Measure the resistance between the terminals with a tester. (Part temperature: 10°C ~ 30°C)						
	<table border="1"> <tr> <td>Color of the lead wire</td> <td>Normal</td> </tr> <tr> <td>BRN-other one</td> <td>235 Ω ~ 255 Ω</td> </tr> </table>		Color of the lead wire	Normal	BRN-other one	235 Ω ~ 255 Ω	
Color of the lead wire	Normal						
BRN-other one	235 Ω ~ 255 Ω						
Horizontal vane motor (MV1)	Measure the resistance between the terminals with a tester. (Part temperature: 10°C ~ 30°C)						
	<table border="1"> <tr> <td>Color of the lead wire</td> <td>Normal</td> </tr> <tr> <td>BRN-other one (250 Ω)</td> <td>235 Ω ~ 255 Ω</td> </tr> <tr> <td>BRN-other one (300 Ω)</td> <td>282 Ω ~ 306 Ω</td> </tr> </table>	Color of the lead wire	Normal	BRN-other one (250 Ω)	235 Ω ~ 255 Ω	BRN-other one (300 Ω)	282 Ω ~ 306 Ω
Color of the lead wire	Normal						
BRN-other one (250 Ω)	235 Ω ~ 255 Ω						
BRN-other one (300 Ω)	282 Ω ~ 306 Ω						
Damper motor (MV2)	Measure the resistance between the terminals with a tester. (Part temperature: 10°C ~ 30°C)						
	<table border="1"> <tr> <td>Color of the lead wire</td> <td>Normal</td> </tr> <tr> <td>BRN-other one</td> <td>282 Ω ~ 306 Ω</td> </tr> </table>	Color of the lead wire	Normal	BRN-other one	282 Ω ~ 306 Ω		
Color of the lead wire	Normal						
BRN-other one	282 Ω ~ 306 Ω						

9-6. TROUBLESHOOTING FLOW

When the left lamp of OPERATION INDICATOR lamp flashes 3 times and the right lamp of OPERATION INDICATOR lamp is not lighted.

Indoor fan does not operate.

A-1. Check of indoor fan motor (upper)

The indoor fan motor error has occurred, and the indoor fan doesn't operate.

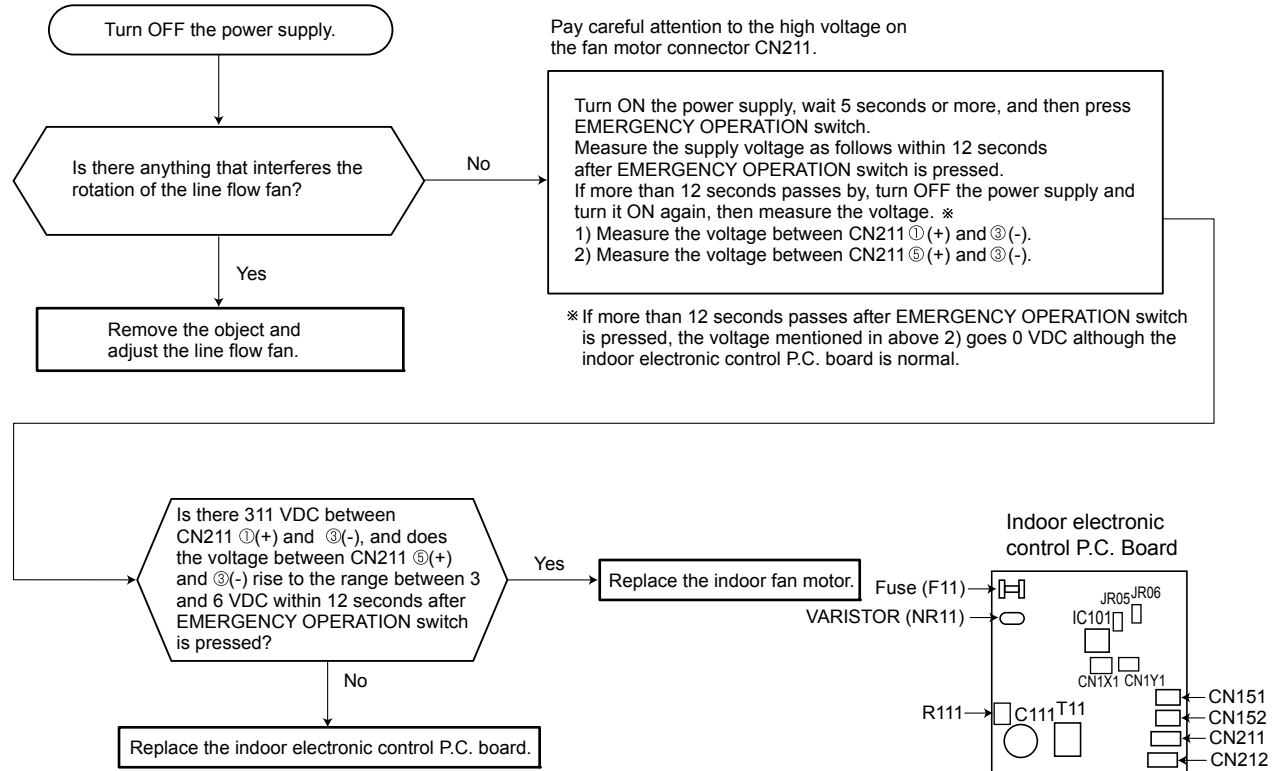

The indoor fan motor error has occurred, and the indoor fan repeats "12-second ON and 30-second OFF" 3 times, and then stops.

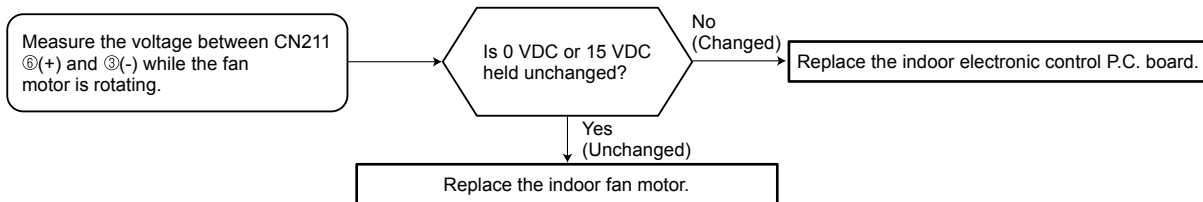

When the left lamp of OPERATION INDICATOR lamp flashes 3 times and the right lamp of OPERATION INDICATOR lamp flashes ON and OFF every 0.5-second.
Indoor fan does not operate.

A-2. Check of indoor fan motor (lower)

The indoor fan motor error has occurred, and the indoor fan does not operate.

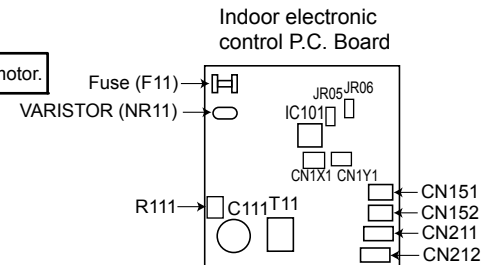
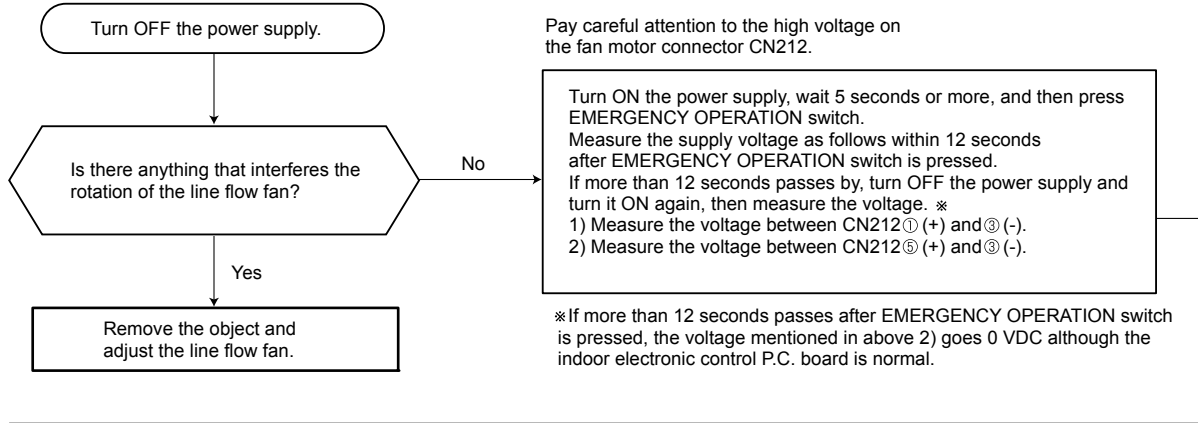

The indoor fan motor error has occurred, and the indoor fan repeats "12-second ON and 30-second OFF" 3 times, and then stops.

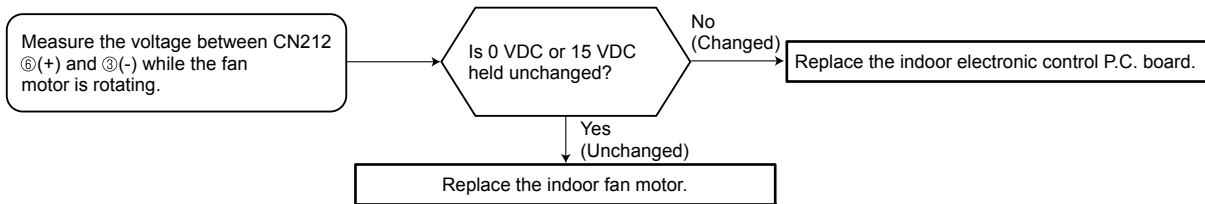

B Check of remote controller and indoor electronic control P.C. board

※Check if the remote controller is exclusive for this air conditioner.

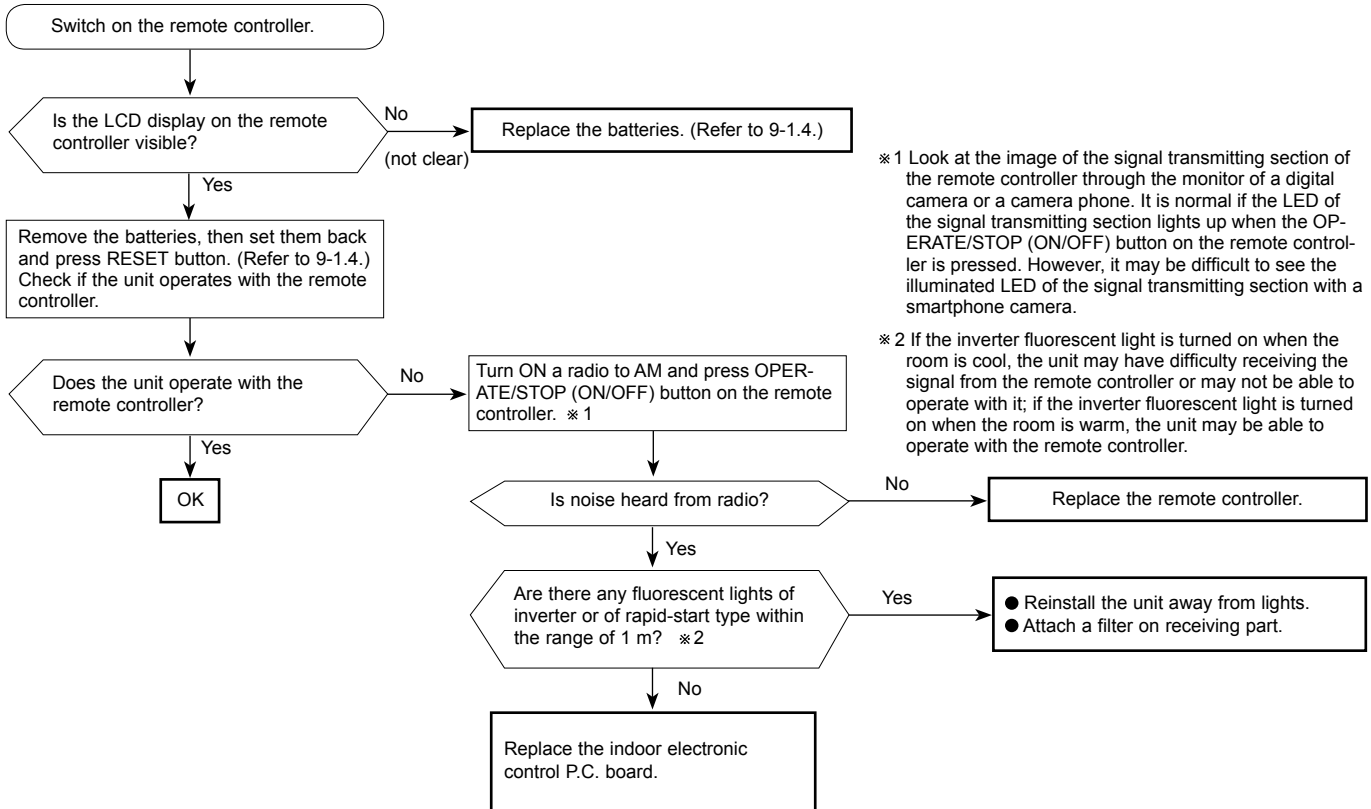

The unit cannot be operated with the remote controller.
 Also, OPERATION INDICATOR lamp does not light up by pressing EMERGENCY OPERATION switch.

© Check of indoor P.C. board and indoor fan motor

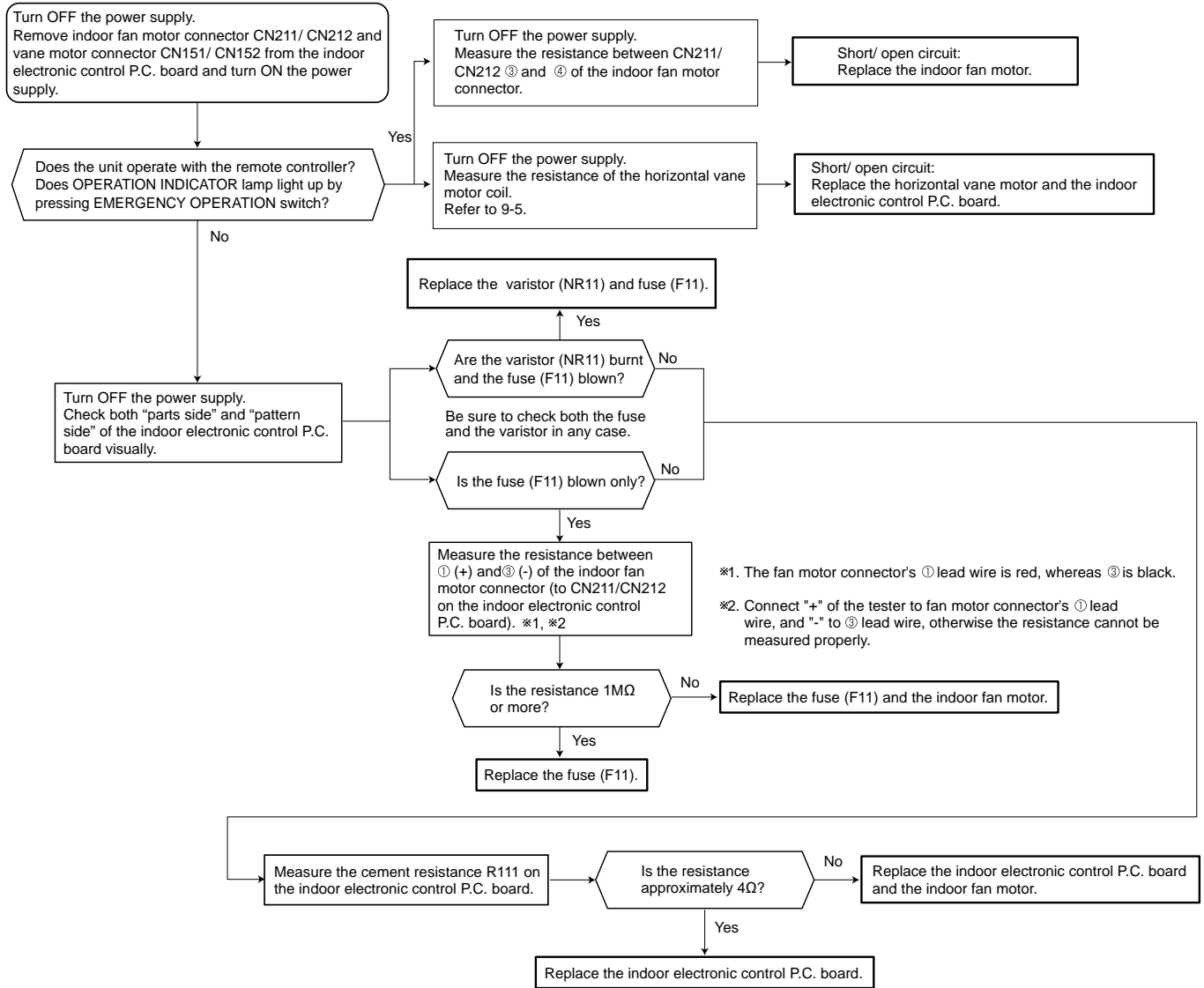

When the left lamp of OPERATION INDICATOR lamp flashes ON and OFF in every 0.5-second. Outdoor unit does not operate.

D How to check miswiring and serial signal error

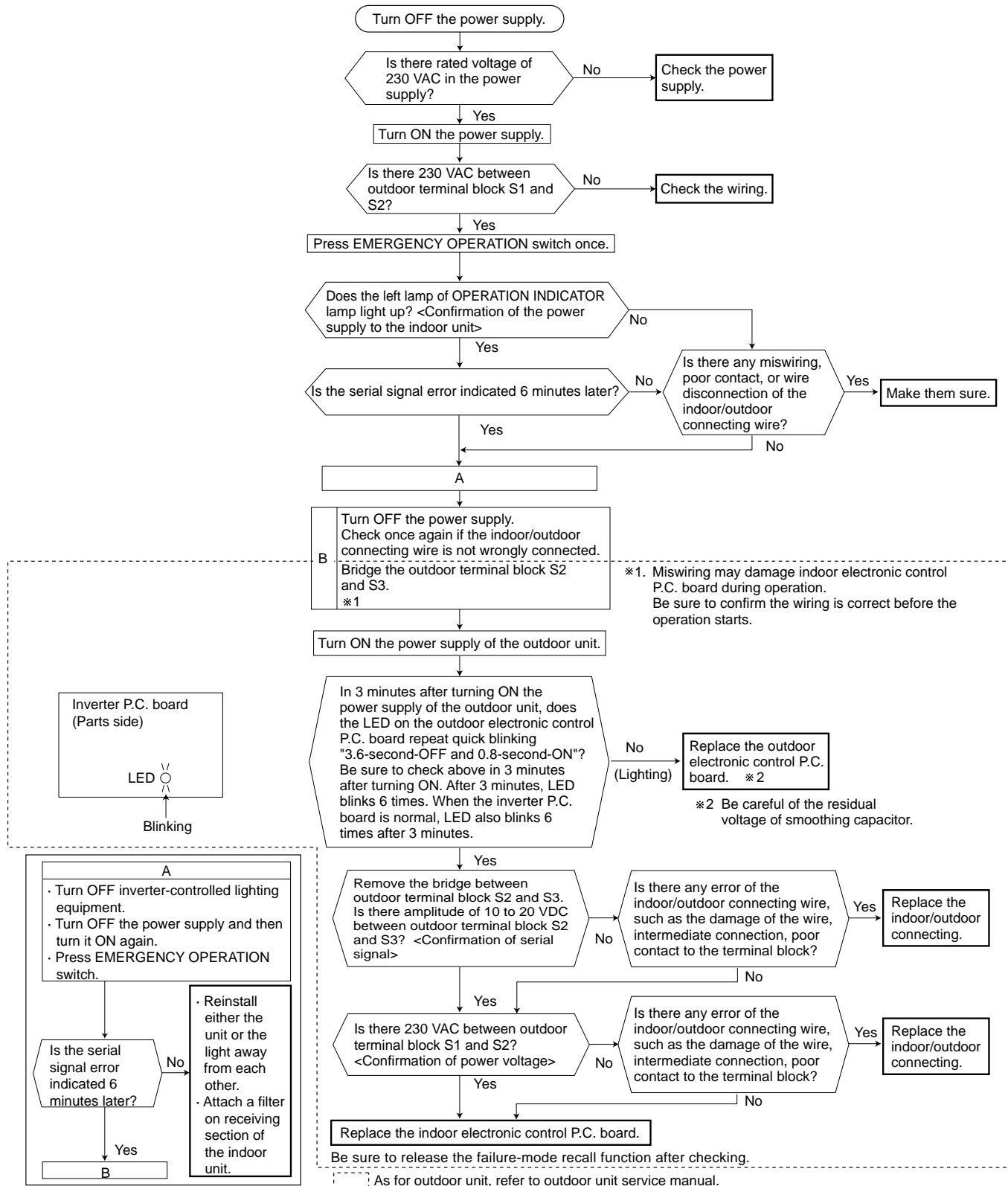

**When the left lamp of OPERATION INDICATOR lamp flashes 15-time.
Indoor unit and outdoor unit do not operate.**

(E) Check of damper

After performing the check, make sure to release the failure mode recall function.

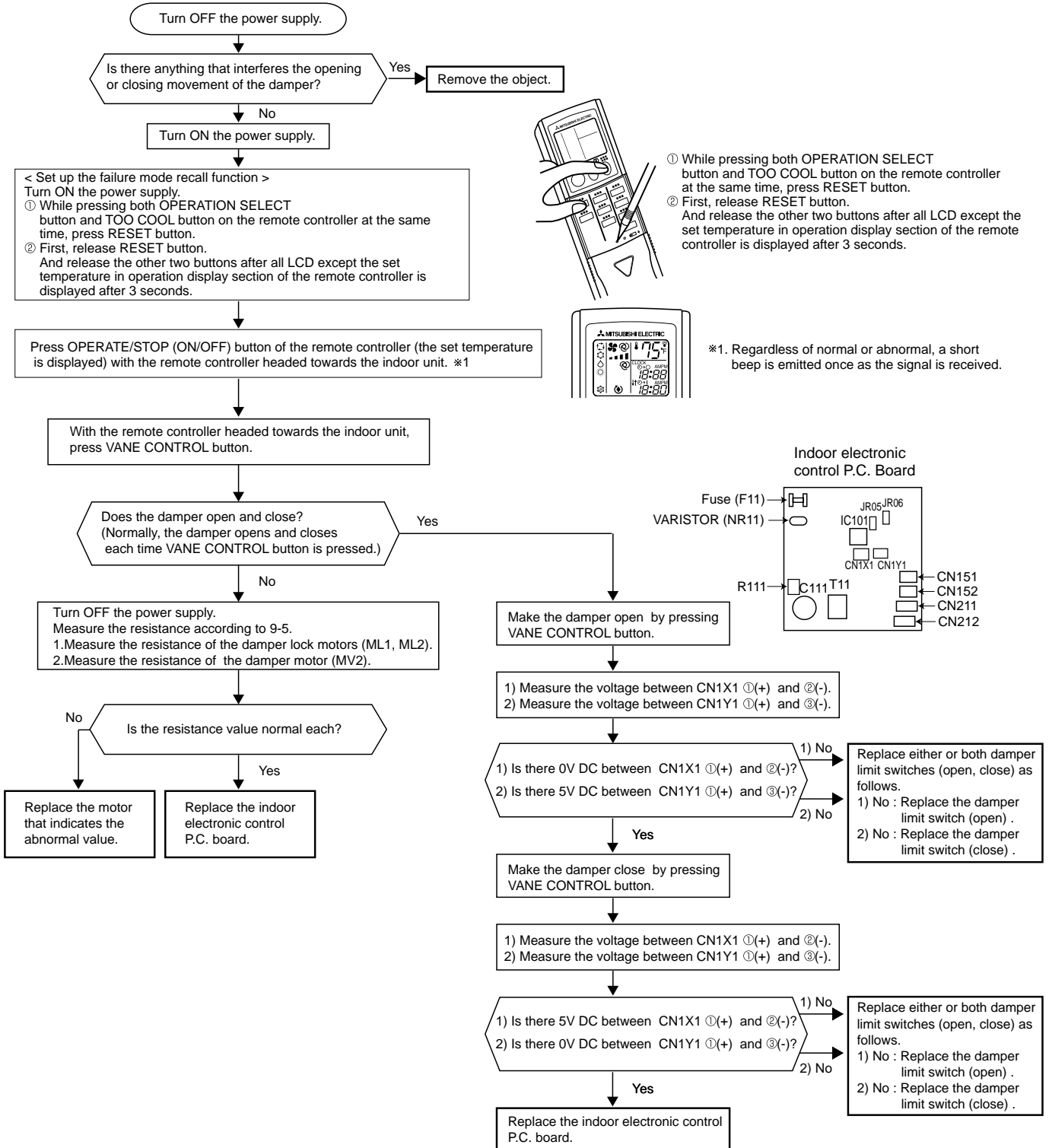

F Electromagnetic noise enters into TV sets or radios

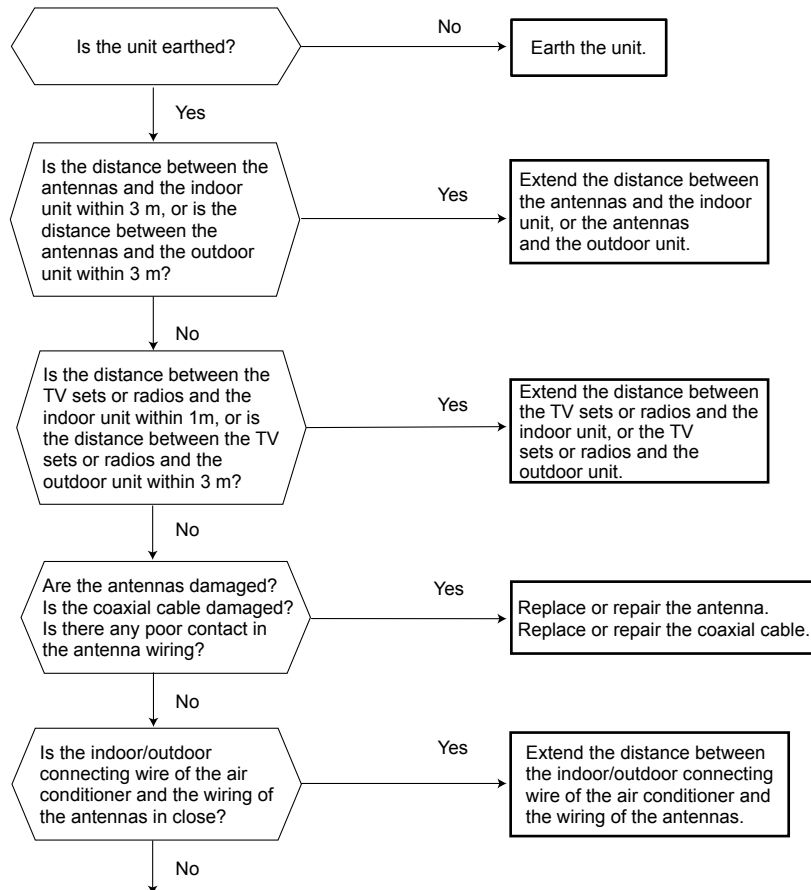

Even if all of the above conditions is fulfilled, the electromagnetic noise may enter, depending on the electric field strength or the installation condition (combination of specific conditions such as antennas or wiring).
 Check the followings before asking for service.

- 1.Devices affected by the electromagnetic noise
 TV sets, radios (FM/AM broadcast, shortwave)
- 2.Channel, frequency, broadcast station affected by the electromagnetic noise
- 3.Channel, frequency, broadcast station unaffected by the electromagnetic noise
- 4.Layout of ;
 indoor/outdoor unit of the air conditioner, indoor/outdoor wiring, grounding wire, antennas, wiring from antennas, receiver
- 5.Electric field intensity of the broadcast station affected by the electromagnetic noise
- 6.Presence or absence of amplifier such as booster
- 7.Operation condition of air conditioner when the electromagnetic noise enters in.
 - 1)Turn OFF the power supply once, and then turn ON the power supply. In this situation check for the electromagnetic noise.
 - 2)Within 3 minutes after turning ON the power supply, press OPERATE/STOP (ON/OFF) button on the remote controller for power ON, and check for the electromagnetic noise.
 - 3)After a short time (3 minutes later after turning ON), the outdoor unit starts running. During operation, check for the electromagnetic noise.
 - 4)Press OPERATE/STOP (ON/OFF) button on the remote controller for power OFF, when the outdoor unit stops but the indoor/outdoor communication still runs on. In this situation check for the electromagnetic noise.

After checking the above, consult the service representative.

9-7. TEST POINT DIAGRAM AND VOLTAGE
MFZ-KA09NA MFZ-KA12NA MFZ-KA18NA
Indoor electronic control P.C. board

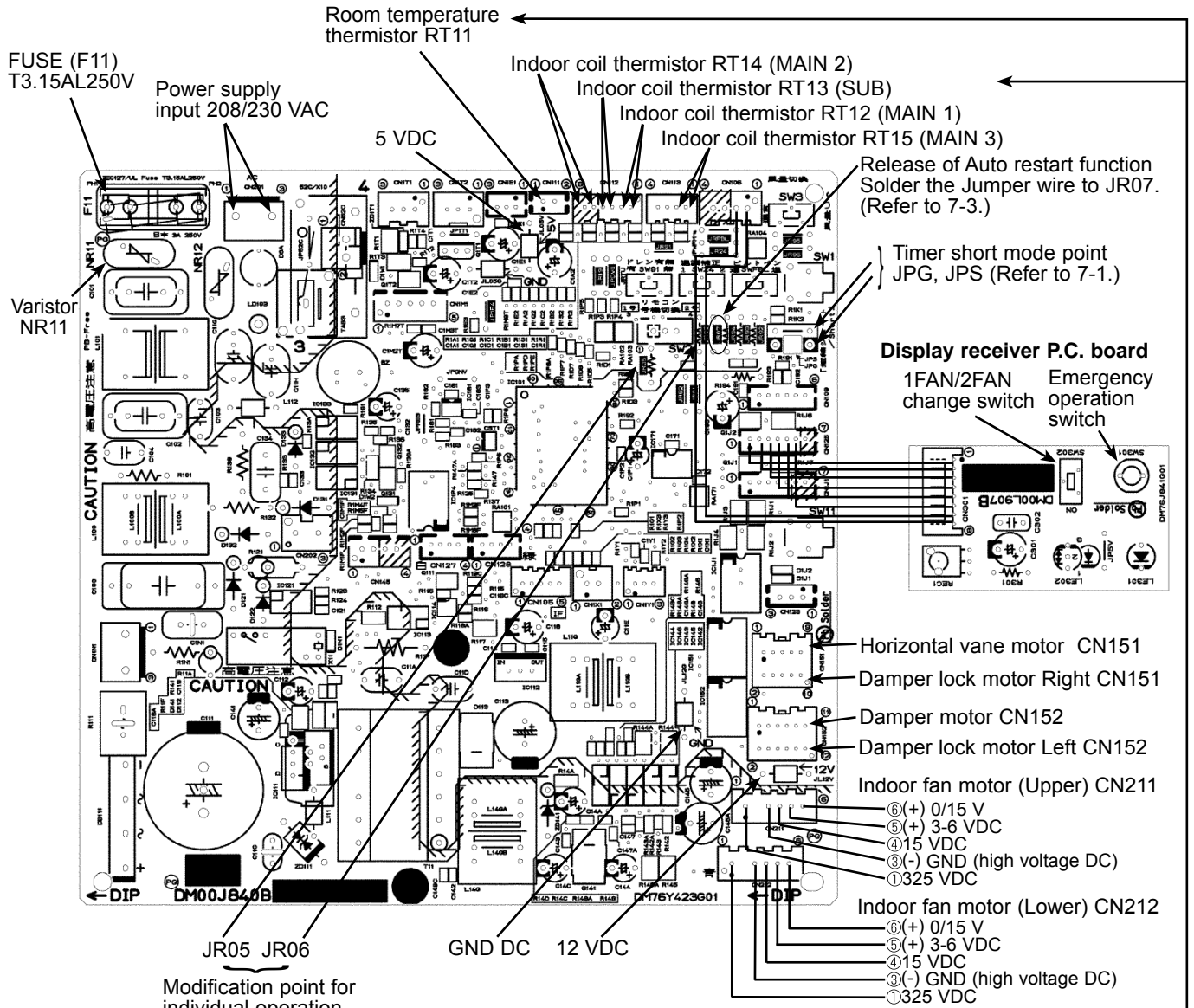

**Indoor coil thermistor [RT12,RT14,RT15 (MAIN), RT13 (SUB)]
 Room temperature thermistor (RT11)**

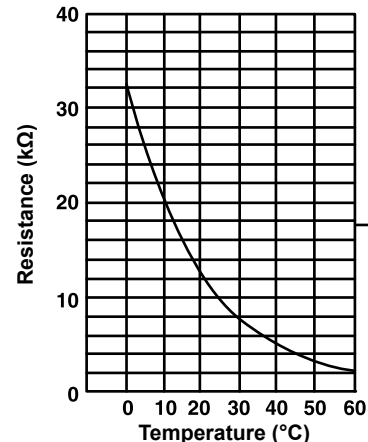

<"Terminal with locking mechanism" Detaching points>

The terminal which has the locking mechanism can be detached as shown below.
 There are two types (refer to (1) and (2)) of the terminal with locking mechanism.
 The terminal without locking mechanism can be detached by pulling it out.
 Check the shape of the terminal before detaching.

(1) Slide the sleeve and check if there is a locking lever or not.

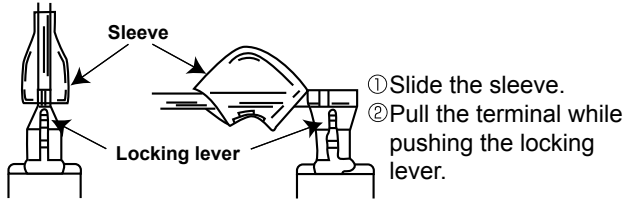

(2) The terminal with this connector has the locking mechanism.

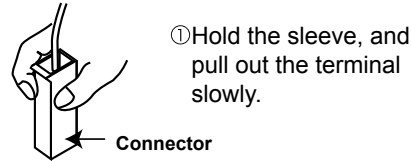

**MFZ-KA09NA MFZ-KA12NA MFZ-KA18NA
INDOOR UNIT**

NOTE: Turn OFF the power supply before disassembly.

OPERATING PROCEDURE	PHOTOS
<p>1. Removing the panel</p> <p>(1) Push both sides of the upper part of the front grille and pull the front grille open, and then remove the front grille from the panel. (See Photo 1.)</p> <p>(2) Remove the screws of the panel. (See Photo 2.)</p> <p>(3) Open the horizontal vane and push the left, right and middle of the upper part of the panel, and pull the panel toward you. (See Photo 2.)</p> <p>(4) Lift up the panel and remove it from the box.</p>	<p>Photo 1</p> <p>Photo 2</p>

OPERATING PROCEDURE

2. Removing the electronic control P.C. board and the display receiver P.C. board

- (1) Remove the panel. (Refer to 1.)
- (2) Remove the screw of the electrical cover, and then the electrical cover. (See Photo 3.)
- (3) Remove the screw of the indoor/outdoor connecting wire, and then the indoor/outdoor connecting wire.
- (4) Unhook the lamp cover from the catch. (See Photo 4.)
- (5) Open the lamp cover. Pull out the display receiver P.C. board, and disconnect the connector on the display receiver P.C. board.
- (6) Remove the screw of the wire connected from the electronic control P.C. board, and then the wire. (See Photo 4.)
- (7) Pull the electronic control P.C. board slightly toward you from the electrical box, and disconnect all the connectors on the electronic control P.C. board.
- (8) Pull out the electronic control P.C. board from the electrical box.

NOTE: Skip (4) and (5) when the display receiver P.C. board does not have to be removed.

3. Removing the electrical box

- (1) Remove the panel. (Refer to 1.)
- (2) Remove the electrical cover. (Refer to 2.)
- (3) Remove the screw of the indoor/outdoor connecting wire, and then the indoor/outdoor connecting wire. Remove the ground wire as well.
- (4) Remove the screw of the conduit plate, and then the conduit plate. (Refer to Photo 4.)
- (5) Remove the screws of the wires connected from the heat exchanger and the box assembly, and then both the wires. (See Photo 4.)
- (6) Pull the electronic control P.C. board slightly toward you. Disconnect the following connectors on the electronic control P.C. board. (See Photo 5.)
 - Fan motor connectors < CN211, CN212 >
 - Horizontal vane motor connector < CN151 >
 - Damper motor connector < CN152 >
 - Display receiver P.C. board connectors < CN106, CN125 >
 - Indoor coil thermistor connectors < CN112, CN113 >
 - Room temperature thermistor connector < CN111 >
 - Damper limit switch connectors < CN1X1, CN1Y1 >
 - Upper nozzle assembly relay connector.
- (7) Remove the screw of the electrical box. (See Photo 4.)
- (8) Unhook the electrical box from the upper catch and pull out the electrical box from the box.

PHOTOS

Photo 3

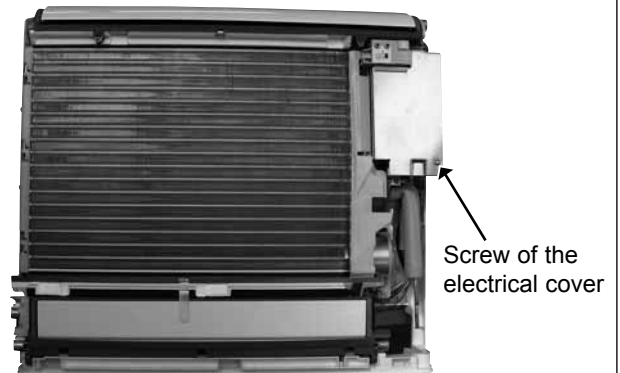

Photo 4

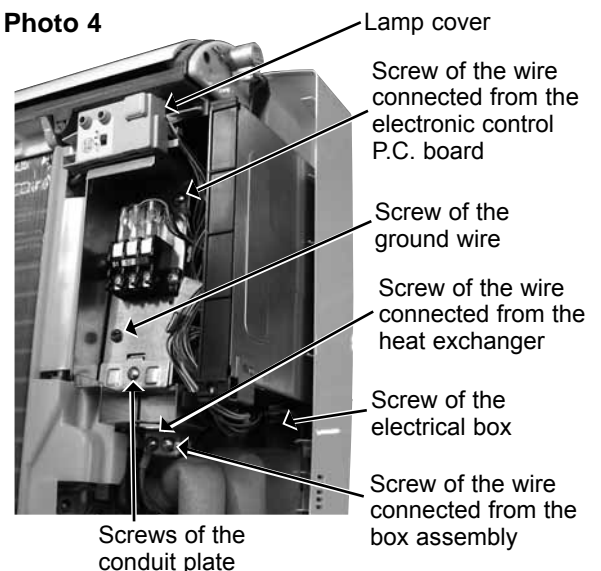
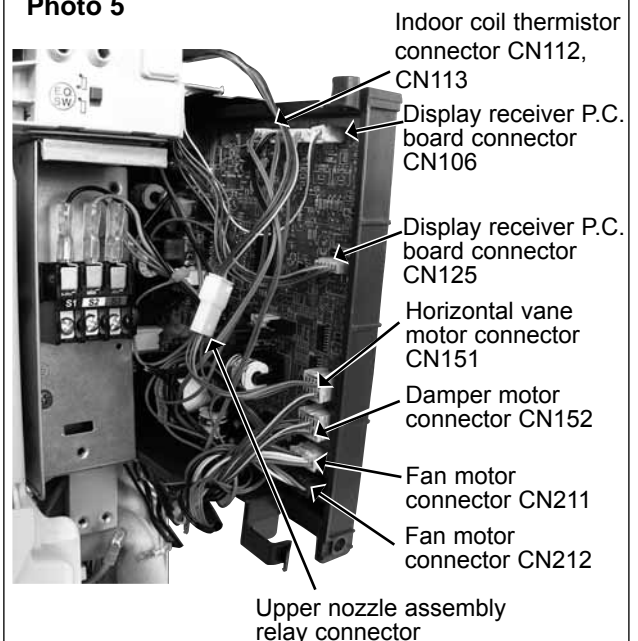

Photo 5



OPERATING PROCEDURE

PHOTOS

4. Removing the horizontal vane motor unit

- (1) Remove the panel. (Refer to 1.)
- (2) Remove the screws of the horizontal vane motor unit and pull out the horizontal vane motor unit. (See Photo 6.)
- (3) Disconnect the connector from the horizontal vane motor unit.

Photo 6

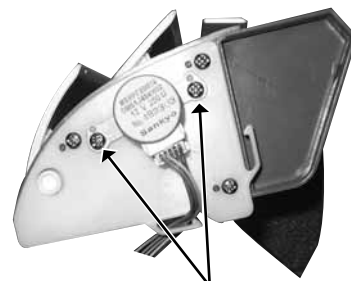

Screw of the horizontal vane motor unit

5. Removing the indoor fan motor (upper)

- (1) Remove the panel. (Refer to 1.)
- (2) Remove the electrical box. (Refer to 3.)
- (3) Remove the nozzle (upper). (See Photo 7.)
- (4) Unhook the water cover from the catches and remove the water cover. (See Photo 7.)
- (5) Removing the screw of the motor band, and then the motor band. (See Photo 8.)
- (6) Remove the line flow fan and the indoor fan motor (upper) from the box.

Photo 7

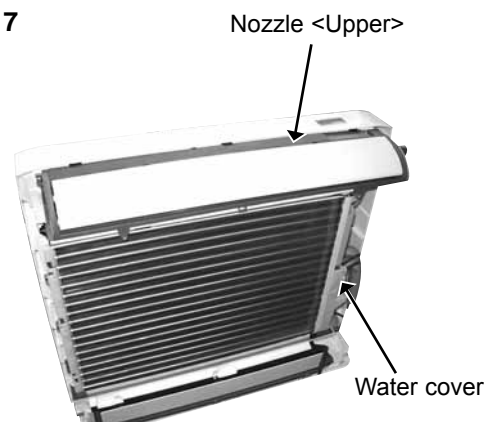

Nozzle <Upper>

Water cover

Photo 8

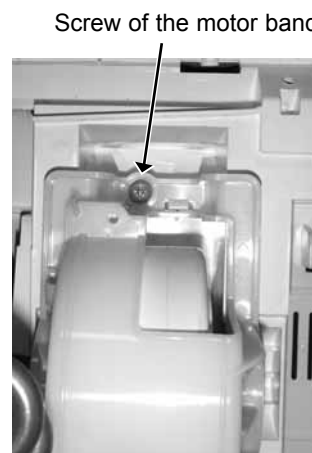

Screw of the motor band

OPERATING PROCEDURE

6. Removing the damper lock motor, the damper motor and the damper limit switch

- (1) Remove the panel. (Refer to 1.)
- (2) Remove the screws of the nozzle assembly (lower). (See Photo 9.)
- (3) Remove the drain hose from the nozzle assembly (lower) and pull out the nozzle assembly (lower) toward you.
- (4) Remove the tape fixing the lead wires of the damper motor and the damper lock motor from the nozzle assembly <lower>. (See Photo 10.)
- (5) Remove the screws of the damper lock motor. (See Photo 11 and 12.)
- (6) Lift the nozzle slightly and remove the lock shaft from with in the nozzle and remove the damper lock motors (ML1, ML2).
- (7) Remove the screws of the damper motor support, and then the damper motor support.
- (8) Remove the screws of the damper motor, and then the damper motor from the damper motor support.
- (9) Disconnect the connector from the damper motor.
- (10) Remove the damper limit switches (LS1, LS2).

7. Removing the indoor fan motor (lower)

- (1) Remove the panel. (Refer to 1.)
- (2) Remove the nozzle assembly (lower) and the drain hose. (Refer to 6.)
- (3) Remove the screw of the ground wire of the indoor fan motor (lower), and then the ground wire. (See Photo 13.)
- (4) Remove the screw of the motor band, and then the motor band. (See Photo 13.)
- (5) Remove the line flow fan and the indoor fan motor (lower) from the box.

Photo 13

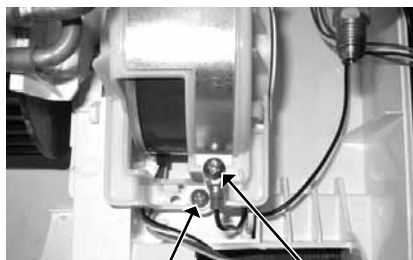

Screw of the motor band
Screw of the ground wire

PHOTOS

Photo 9

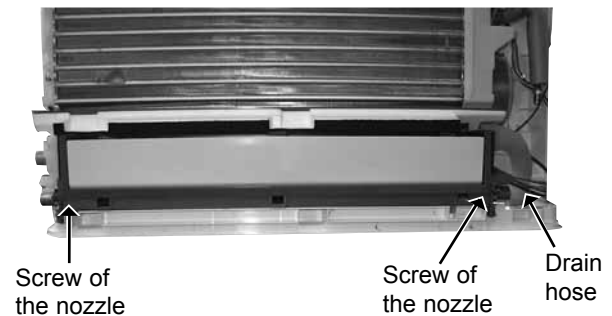
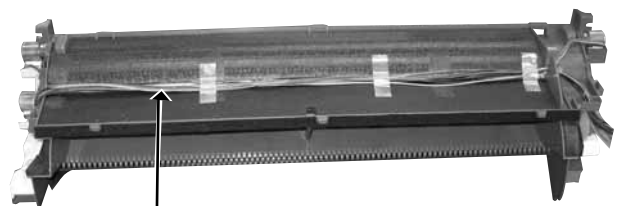

Photo 10



Lead wires of the damper motor and the damper lock motor

Photo 11

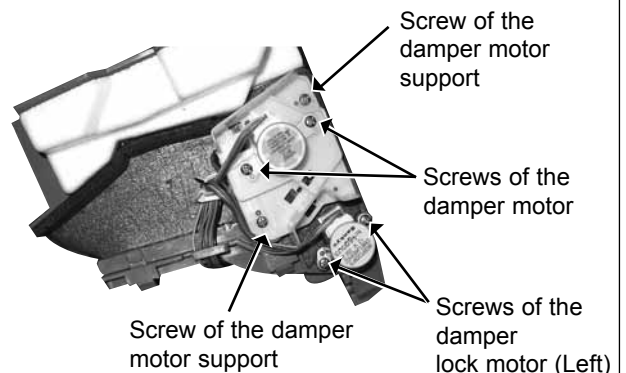
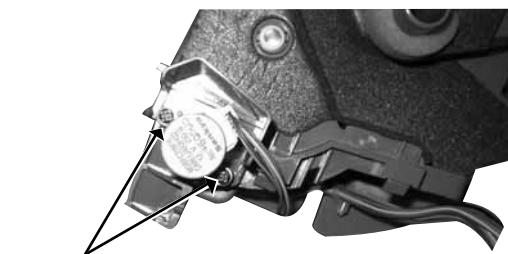

Photo 12



Screws of the damper lock motor (Right)

MITSUBISHI ELECTRIC CORPORATION

HEAD OFFICE: TOKYO BLDG., 2-7-3, MARUNOUCHI, CHIYODA-KU, TOKYO 100-8310, JAPAN

© Copyright 2010 MITSUBISHI ELECTRIC CO.,LTD
Distributed in Dec. 2014. No. OBH568 REVISED EDITION-A
Distributed in Jan. 2010. No. OBH568 7
Made in Japan

New publication, effective Dec. 2014
Specifications are subject to change without notice.