

1 to 6 Ton Vertical Wall Mount Air Conditioners

Models AVPA12-20-24-30-36-42-48-60-72 (Single Stage Compressor)
Models AVHA12-20-24-30-36-42-48-60 (Single Stage Compressor)

Models HVEA24-30-36-42-49-60 (Single Stage Compressor)
Models HVESA36-42-49-60 & AVHSA72 (2-Stage Compressor)



General Description

Used primarily to cool electronic and communication equipment shelters, Marvair[®] ComPac[®] I and ComPac[®] II air conditioners are problem solvers for a wide range of conditions and applications. Due to the high internal heat load, these shelters require cooling even when outside temperatures drop below 60°F (15°C). The ComPac I and ComPac II air conditioners have the necessary controls and components for operation during these (less than 60°F [15°C]) temperatures. All models use the non-ozone depleting R-410A refrigerant.

The primary difference between the ComPac I and the ComPac II units is that the ComPac[®] II air conditioner has a factory installed economizer. When ambient conditions are cool and dry, the economizer uses outside air to cool the shelter. The economizer provides temperature control, energy cost savings, and increased reliability by decreasing the operating hours of the compressor and the condenser fan. To insure proper operation and optimum performance, all economizers are non-removable, factory installed and tested. In addition, factory and field installed accessories can be used to meet specific requirements.

► **Standard Efficiency Models**

AVPA: Marvair's most popular model with an Energy Efficiency Ratio (EER) of 9.0 to 10.0. The ComPac AVPA is available in cooling capacities of 1, 1.5, 2, 2.5, 3, 3.5, 4, 5 and 6 tons (12,000 BTUH to 72,000 BTUH).

► **High Efficiency Models**

HVEA: Marvair's most efficient wall mount air conditioners. Electronically commutated indoor fan motors combined with highly efficient scroll compressors result in Energy Efficiency Ratios (EER's) of up to 11.75.

AVHA: ComPac models with an EER of 10.0. The AVPA72 is also rated 10 EER.

► **2-Stage Compressor Models**

HVESA/AVHSA: ComPac models 36-42-49-60-72 have a 2-stage compressor with first stage cooling approximately 65% of the total cooling capacity. The 2-stage compressor provides lower start-up amps which can be critical when operating with a generator. The two stage compressor can also reduce energy costs and is able to more precisely match the cooling capacity of the air conditioner with the heat load in the shelter. *Both non-economizer and economizer-equipped ComPac units are available with 2 stage compressors.*



AVPA36ACA



Features and Benefits

Built-In Energy Savings

- Optional Factory Installed Economizer
- Four Model Lines to Meet Any Budget and Efficiency Requirements
- Available EER of up to 11.75
- Available 2-Stage Compressor on HVESA Models

R-410A Refrigerant

- Efficient Heat Release
- Non-Ozone Depleting Refrigerant
- Synthetic Lubricant
- Reduced Compressor Wear

High Efficiency and Reliability

- High Efficiency Compressor and Lanced Coil Fins
- High/Low Pressure Switches with Lockout & Short Cycle Protection

Ease of Installation and Service

- Side Access Panels for Power Connections
- Built-In Mounting Flanges and Internal Disconnect
- Standard Access Valves and Filters, Status LEDs

Safety Listed and Energy Certified

All ComPac air conditioners are built to UL standard 1995, 4th edition and CAN/CSA C22.2, No. 236-11. For energy efficiency and performance, the units are tested and rated in accordance to the ANSI/ARI (Air-Conditioning and Refrigeration Institute) Standard 390- 2003 (Single Package Vertical Units). All units meet or exceed the efficiency requirements of ANSI/ASHRAE/IESNA 90.1.2010. Marvair ComPac air conditioners are commercial units and are not intended for use in residential applications.

Standard Features

➤ Designed for Operation in Low Ambient Conditions

- Low ambient control cycles condenser fan to maintain proper refrigerant pressures. Allows operation in mechanical cooling (compressor) of our standard air conditioners down to 20°F (-7°C). With the Extreme Duty option, the units will operate down to 0°F (-18°C). Note: low temperature operation is affected by ambient conditions, e.g. wind and humidity.
- Three minute by-pass of the low pressure switch for start-up of compressor when outdoor temperatures are below 55°F (13°C).
- Optional economizer.

➤ High Efficiency

- High efficiency compressor.
- Lanced fins standard on all evaporator and condenser coils.

➤ Built-in Reliability

- High pressure switch and low pressure switch with lockout protects refrigerant circuit.
- Adjustable .03 to ten minute delay on make for short cycle protection.

➤ Remote Alarm Capability

- Dry contacts can be used for remote alarm or notification upon air conditioner lockout.

➤ Ease of Service

- Service access valves are standard.
- Standard 2" (50 mm) pleated filter with a MERV rating of 8 changeable from outside.
- All major components are readily accessible.
- Front Control Panel allows easy access and complies with NEC clearance codes on redundant side-by-side systems.
- LEDs indicate operational status and fault conditions.
- Foil backed insulation on the indoor air path.
- A minimum position potentiometer that can be adjusted to prevent the economizer damper from closing completely. This control ensures that whenever the evaporator fan is operating, fresh air is being introduced into the building.

➤ Rugged Construction

- Copper tube, aluminum fin evaporator & condenser coils.
- Field or factory installed heaters on discharge side of evaporator coil (optional)
- Baked on neutral beige finish over galvanneal steel for maximum cabinet life. (Other finishes are available.)

➤ Ease of Installation

- Sloped top with flashing eliminates need of rainhood.
- Built-in mounting flanges facilitate installation and minimize chance of water leaks.
- Supply and return openings exactly match previous models.
- Factory installed disconnect.
- Single Point Power Entry complies with latest edition of U.L. Standard 1995.
- Side access panels on economizer models for easy access to electrical connections.
- Phase monitor on all 3-Phase units to continuously measures the voltage of each of the three phases. Separate sensing of low/high voltage, voltage imbalance including phase loss and phase reversal.

A Marvair® First – Factory Installed Economizer

Marvair's ComPac® II air conditioner has been the industry standard since its introduction in 1986. Tens of thousands of ComPac II air conditioners are in operation from the metropolitan areas of North America to the deserts of the Mid-East to the Siberian tundra. Here's how the economizer works:

On a signal from the wall mounted indoor thermostat that cooling is required, either mechanical cooling with the compressor or free cooling with the economizer is provided. A factory installed enthalpy controller determines whether the outside air is sufficiently cool and dry to be used for cooling. If suitable, the compressor is locked out and the economizer damper opens to bring in outside air. Integral pressure relief allows the interior air to exit the shelter, permitting outside air to enter the shelter. The temperature at which the economizer opens is adjustable from 63°F (17°C) at 50% Relative Humidity to 73°F (23°C) at 50% Relative Humidity.

After the enthalpy control has activated and outside air is being brought into the building, the mixed air sensor measures the temperature of the air entering the indoor blower and then modulates the economizer damper to mix the right proportion of cool outside air with warm indoor air to maintain 50-63°F (10 - 17°C) air being delivered to the building. This prevents shocking the electronic components with cold outside air. The compressor is not permitted to operate when the economizer is functioning.

If the outside air becomes too hot or humid, the economizer damper closes completely, or to a field selectable minimum open position, and mechanical cooling is activated.

In all ComPac II air conditioners, the supply air flow in the economizer mode is the same or greater than the rated air flow. (The rated air flow is the AHRI certified air flow when the unit is in mechanical cooling.) The “full flow” economizer reduces electrical costs by maximizing the use of outside air for cooling.

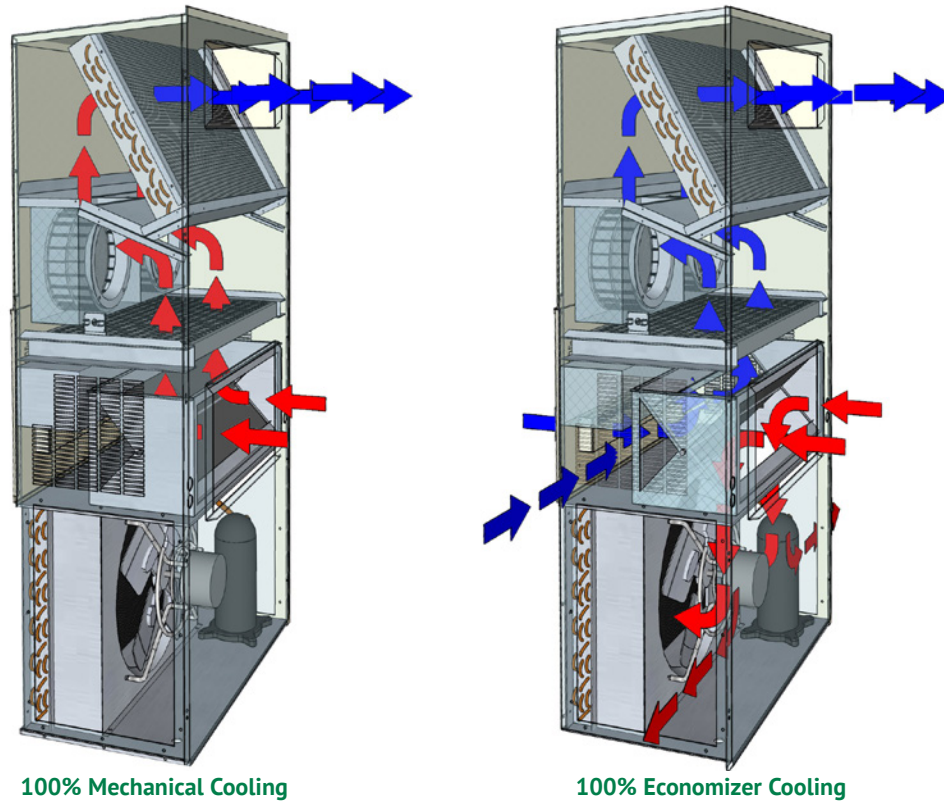

Savings with an Economizer

The following table shows the annual electrical cost of cooling a 10 ft. x 20 ft. x 9 ft. (3m x 6m x 2.7m) shelter in twelve cities in the US. Costs are shown for an air conditioner without an economizer (ComPac I units), for an air conditioner with an economizer (ComPac II units) and the savings. The savings do not include any demand charges. The savings are based on the electrical usage of a five ton air conditioner and an electric rate of \$.10 per kilowatt-hour, the approximate average commercial rate in the US.

Hours of Operation	Atlanta, GA	Boston, MA	Chicago, IL	Dallas, TX	Denver, CO	Houston, TX
Annual Compressor & Condenser Motor Run Time without Economizer (Hrs.)	6,531	6,348	6,361	6,628	6,472	6,655
Annual Compressor & Condenser Motor Run Time with Economizer (Hrs.)	3,841	2,153	2,424	3,798	750	4,970
Run Time Savings with the Economizer (Hrs.)	2,690	4,195	3,937	2,830	5,722	1,685
Annual Costs Saving (\$) of 9.0 EER unit with an Economizer (ComPac II)						
Annual Operating Cost 9.0 EER Unit without Economizer (\$)	\$4,100.00	\$3,985.00	\$4,792.00	\$4,161.00	\$3,657.00	\$4,178.00
Annual Operating Cost 9.0 EER with Economizer	\$2,685.00	\$1,784.00	\$2,315.00	\$2,671.00	\$940.00	\$3,291.00
Annual Savings using 9.0 EER Unit with Economizer	\$1,415.00	\$2,201.00	\$2,477.00	\$1,490.00	\$2,717.00	\$887.00

Hours of Operation	Los Angeles, CA	Miami, FL	Phoenix, AZ	Pittsburgh, PA	Seattle, WA	St. Louis, MO
Annual Compressor & Condenser Motor Run Time without Economizer (Hrs.)	6,467	6,779	6,765	6,386	6,465	6,472
Annual Compressor & Condenser Motor Run Time with Economizer (Hrs.)	3,862	6,391	3,106	1,929	1,654	2,716
Run Time Savings with the Economizer (Hrs.)	2,605	388	3,659	4,457	4,811	3,756
Annual Costs Saving (\$) of 9.0 EER unit with an Economizer (ComPac II)						
Annual Operating Cost 9.0 EER Unit without Economizer (\$)	\$4,060.00	\$4,255.00	\$4,247.00	\$4,009.00	\$3,653.00	\$4,063.00
Annual Operating Cost 9.0 EER with Economizer	\$2,686.00	\$4,051.00	\$2,315.00	\$1,667.00	\$1,368.00	\$2,090.00
Annual Savings using 9.0 EER Unit with Economizer	\$1,374.00	\$204.00	\$1,932.00	\$2,342.00	\$2,285.00	\$1,973.00

Shelter Metrics:

- 10' x 20' x 9' building
- Internal heat gain (electronics load): 12,000 watts.
- Building surface area (excluding floor area): 740 ft²
- R-Value of walls and ceiling: R-12
- Internal shelter temperature (Thermostat set point): 75°F

Air Conditioner Metrics:

- ComPac II Economizer setting: 63°F (dry bulb or enthalpy sensor)
- A/C unit capacity: 60,000 BTUH (5 tons) with 1-stage compressor
- Nominal EER (unit efficiency): 10.0 (models AVHA)
- Cost of power: \$.10 per KWH

Controllers and Thermostats

► Controllers

CommStat 6 2/4 Telecom HVAC Controller	P/N 70705
CommStat 6 4/8 Telecom HVAC Controller	P/N S/12087-04
CommStat 6 6/12 Telecom HVAC Controller	P/N S/12087-06

The CommStat 6 is an HVAC controller, is available in three configurations, and is designed specifically for controlling up to six redundant air conditioners with two stage compressors in a telecommunications shelter or enclosure. The **CommStat 6 2/4** controls up to two single or 2-stage air conditioners (4 Stages max.), the **CommStat 6 4/8** controls up to four single or 2-stage air conditioners (8 Stages max.) and the **CommStat 6 6/12** controls up to six single or 2-stage air conditioners (12 Stages max.)



In addition to the control of the air conditioners, the CommStat 6 has multiple configurable outputs for remote alarms or notification. The CommStat 6 is factory programmed with standard industry set points, but can be configured on site. Settings are retained indefinitely in the event of a power loss.

CommStat Touch HVAC Controller NEW!	P/N K/10439
--	-------------

The CommStat Touch telecom controller with a touch screen interface is designed to allow remote control and monitoring of Marvair air conditioners and heat pumps with single or 2-stage compressors in a shelter or enclosure and is certified by ETL for HVAC UL60950-1 and FCC47CFR compliance. In addition to the control of HVAC equipment, CommStat Touch includes the Marvair RemoteLink IPv4/IPv6 communication module to provide status information, alarm notifications, set point adjustment, and remote HVAC configuration. See the CommStat Touch PDS for more details.



CommStat 4 Telecom HVAC Controller	P/N S/7846
---	------------

The CommStat 4 HVAC controller is designed specifically for controlling two redundant air conditioners, heat pumps or air conditioners with 2-stage compressors. The CommStat 4 has seven outputs for remote alarms or notification. Status LED's indicate HEAT, COOL, POWER and the LEAD unit. When a fault is detected, an alarm LED flashes and the LCD screen displays the fault.



The CommStat can be daisy chained with a second CommStat 4 controllers for controlling up to four air conditioners in one shelter. See the CommStat 4 PDS for more details.

CommStat3™ Lead/Lag Microprocessor Controller	P/N S/04581
--	-------------

Solid state controller designed to operate a fully or partially redundant air conditioning system. Ensures equal wear on both air conditioners while allowing the lag unit to assist upon demand. Lead/ lag changeover is factory set at 7 days, but is field programmable in 1/2 day increments from 1/2 to 7 days. The CommStat 3™ Controller has LED's to indicate status & function, digital display of temperature, a comfort override button for energy savings, five alarm relays, a built in temperature sensor and is fully programmable. See the CommStat 3 PDS for more details.



► Thermostats & Thermostat Guards

Note: All air conditioners with 2-stage compressors (models HVESA) require a 2-stage cooling thermostat.

Thermostat	P/N 50123
-------------------------	-----------

Digital thermostat. 1-stage heat, 1-stage cooling. 7 day programmable. Fan switch: Auto & On. Auto-change over. Keypad lockout. Non-volatile program memory.

Thermostat	P/N 50107
-------------------------	-----------

Digital thermostat. 2-stage heat, 2-stage cooling. 7 day programmable. Fan switch: Auto & On. Auto-change over. Status LED's. Backlit display. Programmable fan. Non-volatile program memory.

Thermostat Guard	P/N 50092
-------------------------------	-----------

Thermostat guard for use with the 50123 and 50107 thermostats.

Thermostat	P/N 50218
-------------------------	-----------

Digital, non-programmable thermostat. 1-stage cooling and 1-stage heat. Auto-changeover.

Digital Humidistat	P/N 50254
---------------------------------	-----------

To be used with units with hot gas or electric reheat. Programmable dehumidistat and ventilation controller. Permanent memory retention of set points. Humidity sensor can be field calibrated. High & low dehumidification set points. Outdoor temperature and humidity sensor included. °F or °C selectable.

Thermostat	P/N 50252
-------------------------	-----------

Non-programmable digital thermostat with backlit display. 2 stage heat and 2-stage cooling. Auto changeover.

Operation of 2-Stage Compressor Air Conditioners with a CommStat Touch, CommStat 4™ or CommStat 6 Lead/Lag Thermostat Controller

Marvair's HVESA and AVHSA air conditioners have 2-stage compressors. These units can provide substantial energy savings and better control of temperature and humidity by matching the cooling requirement with the performance of the air conditioner. First stage is typically 65% of the total (2-stage) capacity of the air conditioner. When operated from power supplied by a generator, starting the air conditioner in the first stage means lower start-up amps.

- **CommStat Touch or CommStat™ 4 Controller:** When two, 2-stage air conditioners are controlled by a CommStat 4 lead/lag controller in a redundant application, one of the air conditioners is the lead unit and the second is the lag unit. On a call for cooling, the lead unit starts operation in the first stage (low capacity). If the temperature in the building continues to rise above the set point temperature, the first stage (low capacity) of the lag unit will be initiated. When the temperature in the building drops to the set point, the air conditioners will turn off. On a subsequent call for cooling the process will repeat.

If the set point temperature is not reached with the first stage capacity operation of both air conditioners, the lead air conditioner will commence operation in second stage (full capacity). If the temperature in the building continues to rise past the setpoint, the lag unit will switch to second stage cooling operation. At that time, both air conditioners are operating in maximum capacity.

- **CommStat™ 6 Controller:** When two, 2-stage air conditioners are controlled by a CommStat 6 lead/lag controller in a redundant application, one of the air conditioners is the lead unit and the second is the lag unit. On a call for cooling, the lead unit starts operation in the first stage (LOW capacity). If the temperature in the building continues to rise above the set point temperature, the second stage (FULL capacity) of the LEAD unit will be initiated. When the temperature in the building drops to the set point, the unit will turn off. On a subsequent call for cooling the process will repeat.

If the set point temperature is not reached with second stage capacity operation of the LEAD air conditioner, the LAG air conditioner will commence operation in first stage (LOW capacity). If the temperature in the building continues to rise past the setpoint, the lag unit will switch to second stage cooling operation. At that time, both air conditioners are operating in maximum capacity.

When the temperature in the building is satisfied with either controller, both units will turn off.

If the units have economizers (ComPac II air conditioners), the enthalpy sensor determines whether to use outside air or use mechanical cooling. When the economizer is used, the compressors do not operate.

Marvair's AVPA12 One Ton Air Conditioner

Ideal Replacement for Old Window Air Conditioners or New Construction

The electronic/communication shelter requires cooling virtually year-round because of the heat load generated by the internal electronic equipment (i.e., switching and transmission gear). Residential window room air conditioners are not designed to operate when outside air temperatures are moderate to cold, i.e., below 65°F (18°C). Typical problems are freezing of the coil, diminished capacity and compressor damage which all contribute to high maintenance and short operating life.

The Marvair® AVPA12 One Ton ComPac® I and ComPac® II air conditioners are designed for the electronic/ communication shelter to provide a commercial grade air conditioner for years of operation. The Marvair One Ton is built to operate continuously and efficiently in a variety of outside conditions. For existing shelters with window air conditioners, upgrading to the commercial grade Marvair air conditioners is made easy by the design of the One Ton ComPac II unit with the factory installed economizer. The back panel is designed for either a 19"W x 21"H (483 mm x 533 mm) or 28"W x 19"H (711 mm x 483 mm) opening, standard opening sizes for many window units. The unit is shipped from the factory for mounting on a 19"W x 21"H (483 mm x 533 mm) opening, but can be easily changed at site to fit in a 28"W x 19"H (711 mm x 483 mm) opening. With the built-in mounting flanges, the air conditioner mounts quickly and simply to the exterior of the building. The single piece supply and return grille attaches easily to the wall sleeve to complete the installation. The ComPac I (non-economizer) unit has separate supply and return grilles. (See the Accessories section for the part numbers of the grilles and wall sleeves). Factory installed electric heat is available in the Marvair One Ton Air Conditioner thus eliminating baseboard heat and a second power source.

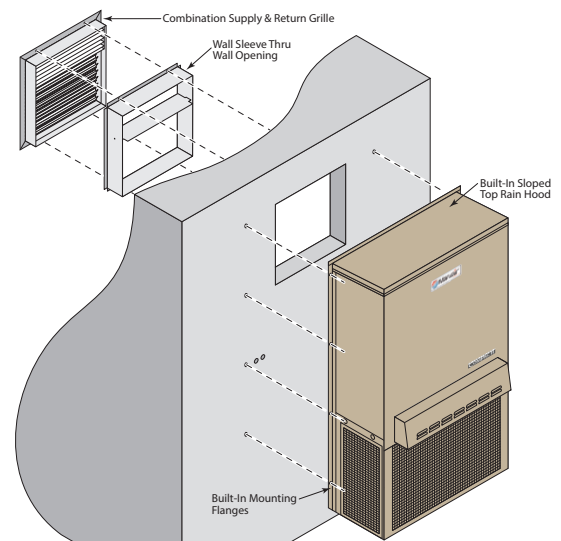

Accessories

► Supply Grilles

For AVPA/AVHA20,24.....	P/N 80674
20" x 8" (508 mm x 203 mm)	
For AVPA/AVHA30,36 and HVEA24.....	P/N 80675
28" x 8" (711 mm x 203 mm)	
For AVPA/AVHA42,48,60, AVPA72 and HVEA30, 36, 42, 49, 60.....	P/N 80676
30" x 10" (762 mm x 254 mm)	
For HVESA60 Reverse Flow.....	P/N 93197
30" x 16" (762 mm x 406 mm)	

► Return Grilles

For AVPA/AVHA20,24.....	P/N 80677
20" x 12" (508 mm x 305 mm)	
For AVPA/AVHA30,36 and HVEA24.....	P/N 80678
28" x 14" (711 mm x 356 mm)	
For AVPA/AVHA42,48,60, AVPA72 and HVEA30, 36, 42, 49, 60.....	P/N 80679
30" x 16" (762 mm x 406 mm)	
For HVESA60 Reverse Flow.....	P/N 93198
30" x 10" (762 mm x 254 mm)	

► Return Filter Grilles

Used when filter must be changed from the interior. Not recommended for ComPac II air conditioners.

Note: Filter used in Return Filter Grille is 1" (25 mm) thick.

For AVPA20/24.....	P/N 80671
20" x 12" (508 mm x 305 mm)	
For AVPA/AVHA30,36 and HVEA24.....	P/N 80672
28" x 14" (711 mm x 356 mm)	
For AVPA/AVHA42,48,60, AVPA72 and HVEA30, 36, 42, 49, 60.....	P/N 80673
30" x 16" (762 mm x 406 mm)	

► AVPA/AVHA12 Grilles

Supply Air Grille For AVPA12 ComPac I & AVHA12 ComPac I & ComPac II.....	P/N 80682
17" x 5" (432 mm x 127 mm)	
Return Air Grille For AVPA12 ComPac I & AVHA12 ComPac I & ComPac II.....	P/N 92352
17" x 10" (432 mm x 254)	
Return Air Filter Grille For AVPA12 ComPac I.....	P/N 80683
17" x 10" (432 mm x 254)	

► AVPA12 ComPac II with Factory Installed Economizer

<u>Supply/Return Air Grilles and Wall Sleeve for 19"W x 21"H Opening</u>	
Wall Sleeve for 19"W x 21"H (483 mm x 533 mm) opening.....	P/N S/12544
Supply Air Grille for AVPA12 ComPac II, 17" x 5" (432 mm x 127mm).....	P/N 93195
Return Air Grille for AVPA12 ComPac II, 17" x 12" (432 mm x 305mm).....	P/N 93196
<u>Supply/Return Air Grilles and Wall Sleeve for 28"W x 19"H Opening</u>	
Wall Sleeve for 28"W x 19"H (711 mm x 483 mm) opening.....	P/N S/01784
Combination Aluminum Supply and Return Grille for AVPA12 (economizer unit), 26" x 17" (660 mm x 432mm).....	P/N 80681

Options

The ComPac® I and ComPac® II air conditioners were designed and are built to stringent requirements of the communications/electronic shelter. Applications occur that have special requirements. Numerous options are available for the ComPac I and ComPac II air conditioners that meet these special needs.

► Hard Start Kit

Used on single phase equipment to give the compressor higher starting torque under low voltage conditions. (Field installed only) (Note: Not recommended for use on scroll compressors.)

► Dehumidification

ComPac® I and ComPac® II A/C – Allows the electric heat to operate simultaneously with cooling. See

Dehumidification Application Bulletin for details. Note: The electrical characteristics and requirements of air conditioners with the dehumidification option are different from standard air conditioners. Refer to the appropriate Summary Rating Charts for the electrical characteristics of units with Electric Reheat. Available on all units except the AVPA12. Units with reheat require a thermostat and a dehumidistat for proper operation.

► Protective Coating Packages

Typically, only the ComPac I is used in corrosive environments, but the ComPac II air conditioner is also available with corrosion protection. Two corrosion protection packages are offered - one for the condenser section (Coastal Environmental Package) and the other for the entire unit (Coat-All Package).

The Coastal Environmental Package includes:

- Corrosion resistant fasteners
- Sealed or partially sealed condenser fan motor
- Protective coating applied to all exposed internal copper and metal in the condenser section
- Protective coating on the condenser coil (Luvata Insitu®) contains ES2 (embedded stainless steel pigment) technology.

The Coat all Package includes all of the above, plus:

- Protective coating on the evaporator coil (Luvata Insitu®) contains ES2 (embedded stainless steel pigment) technology
- Protective coating on exterior and interior components and sheet metal. (**Note:** the internal sheet metal which is insulated, bottom outside panel, and the internal control box are not coated)

Note: The AVPA12 is available with the protective coatings and corrosion resistant fasteners, but does not have a sealed condenser fan motor.

► Protective Coil Coatings

The Condenser Coil or the Evaporator Coil or Both can be coated. Coating the Evaporator Coil is not common. For harsh conditions, e.g., power plants, paper mills or sites where the unit will be exposed to salt water, the coils should be protected by a protective coating.

Note: Cooling capacity may be reduced by up to 5% on units with coated coils.

► External Low Noise Blower (ELNB)

ComPac® I and ComPac® II A/C – A field installed kit that consists of a condenser air hood, centrifugal blowers, controls and a compressor jacket to reduce the sound level by up to 6 dbA of Marvair ComPac air conditioners. Available for models AVPA30-60. See External Low Noise Blower Product Data Sheet for details.

► ComPac® II Air Conditioner Transition Curb

ComPac II A/C only – A sheet metal curb that enables AVPA42/48/60 ComPac II air conditioner to replace an AVPA30/36 ComPac II unit. Curb transitions supply and return openings of the 3-1/2, 4 and 5 ton units to the smaller openings.

► Hot Gas By-Pass (Non-Economizer Models)

ComPac® I A/C Only – Used in specialty applications; i.e., Magnetic Resonance Imaging (MRI) buildings, to prevent magnetic voltage disturbance caused by compressor cycling. Hot gas by-pass option packages are available to allow operation to 20°F (-7°C). Please refer to Hot Gas By-pass Application Bulletin for details. Not available on the AVPA12, 20 & 24.

► High Filtration

Selected units are built with larger blowers/motors for use with higher efficiency filters with MERV ratings of 11, 13 and 14 when tested to ASHRAE 52.2. Units with economizers have a prefilter on the outside air. Not available on the AVPA12. Contact your Marvair representative for specific models.

► Color

ComPac® air conditioners are available in five different cabinet colors -the standard Marvair® beige, white, gray, brown and dark bronze. The standard cabinet's sides, top and front panels are constructed of 20 gauge painted steel. As an option, these panels can be built of 16 gauge steel in beige & gray or .050 stucco aluminum. When the 16 gauge painted steel or the aluminum is used, only the side, top and front panels are 16 gauge or aluminum. Contact your Marvair representative for color chips. The cabinet can also be constructed of type 316 stainless steel. Two stainless steel cabinet constructions are available- the complete cabinet, including most internal sheet metal or only the exterior sheet metal. Custom colors are also available; contact Marvair for details.



Custom colors available

► Extended Warranty

A first-year labor (Silver), and a two-year labor (Gold) are available. See www.marvair.com for optional warranty details.

➤ **Dirty Filter Indicator**

A factory installed option that measures the difference in pressure across the internal filter and illuminates a LED when the pressure exceeds the desired difference. Not available on the AVPA12.



➤ **Thermal Expansion Valve**

Available on all ComPac air conditioners. Improves performance in hot ambient temperatures.

➤ **Sealed Condenser Fan Motors**

Recommended on units to be installed in corrosive sites, e.g., near the ocean and in deserts with blowing sand. Available on all units except the AVPA12.

➤ **Compressor Sound Jacket**

To reduce sound of compressor. Available on all units except the AVPA12

➤ **Extreme Duty Package** *(Not Available on AVPA12)*

Allows Marvair® air conditioners to operate in extremely cold and hot ambient conditions. The Extreme Duty Kit is always factory installed and is available on all air conditioners. ComPac I units without an economizer will operate from 0°F to 130°F (-18°C to 54°C). ComPac II units with an economizer will operate from -40°F to 130°F (-40°C to 54°C).

The Extreme Duty Package includes a suction line accumulator, thermal expansion valve (TXV), crankcase heater, hard start kit, an auto reset high pressure switch and an outdoor thermostat and fan cycle switch. The fan cycle control is standard on all ComPac air conditioners and operates based upon the liquid line pressure. The outside thermostat opens whenever the outside temperature is below 50°F (10°C) and closes when the outside temperature is 50°F (10°C) or higher. When the temperature is below 50°F (10°C), the fan cycle switch is in the circuit; when temperatures are 50°F (10°C) or higher, the fan cycle switch is not in the circuit. The outdoor thermostat is used with a TXV to prevent excessive cycling or “hunting” of the TXV.



➤ **Lockable Disconnect Access Cover Plate**

The access plate to the service disconnect switch can be equipped with a lockable cover.

➤ **Desert Duty Package** *(Not available on the AVPA12)*

Our standard air conditioners will operate in outside ambient temperatures up to 120°F (48.9°C) The Desert Duty package is a factory installed package of components and cabinet modifications to allow operation in ambient temperatures up 130°F (54°C). Standard features of the Desert Duty package include a thermal expansion valve and a sealed condenser fan motor. Cabinet modifications include a slotted panel in the base pan that improves condenser air flow and also provides access to the compressor and condenser fan motor. To prevent sand and dust infiltration, the electrical control box is sealed. A closed loop design on non-economizer ComPac units insures that no outside air is introduced into the shelter. Note: the ComPac II unit with the economizer may be ordered with the Desert Duty Package. If the ComPac II air conditioner is required with the Desert Duty Package, sand intrusion into the shelter should be considered.

➤ **Washable Filter**

Spun aluminum construction allows cleaning of filters with water.

➤ **Hot Gas Reheat (HGR)**

A Hot Gas Reheat coil and controls allow the indoor humidity of the controlled environment to be maintained at or below a certain humidity set point. These units do not have the ability to add humidity to the room. Dehumidification is achieved by operating mechanical cooling in conjunction with a hot gas reheat coil.

➤ **Right & Left Side Compressor Location**

The air conditioners can be built with the compressor on the opposite side to facilitate service access when two units are installed side by side. In the AVPA20-24-30-36 & AVHA30/36, the standard location for the compressor is on the right hand side. In the AVPA12 and the AVPA42-48-60 & AVHA42-48-60, the standard location for the compressor is on the left hand side. In the 72, the compressor is accessed from the front of the unit and an opposing configuration is not required.

► Marvair Coil Cop® Theft Deterrent System



The Marvair Coil Cop® is a factory installed, multi-layered theft deterrent system designed for use in Marvair wall mounted air conditioners and heat pumps. It provides visual and audio warnings and remote notification in the event of an attempted theft or vandalism of the unit. It is especially useful for air conditioners located in remote or unsupervised locations, e.g., many cell sites, and can eliminate bulky and expensive cages. For a complete description of the components and operation of the Coil Cop system, please see the Coil Cop brochure (available for download at www.marvair.com).

Two variations of the Coil Cop theft deterrent system are available:

- **Coil Cop Variation T1** is the complete Coil Cop Package. Includes stainless steel channels to secure both the condenser and evaporator coils, warning labels, a speaker, tamper resistant fasteners, loss of charge switch, tri-axis accelerometer and operator panel with status lights.
- **Coil Cop Variation T2** includes stainless steel channels to secure the condenser coil, warning labels, a speaker, tamper resistant fasteners, loss of charge switch, tri-axis accelerometer and operator panel with status lights. Variation T2 does not include stainless steel channel on the evaporator coil.

Remote Access Data Points

Through the Ethernet connection, the network operations center can monitor and change various data points in the HVAC system and the shelter.

Data Points which can be monitored **and** changed:

- First Stage Cooling Set Point Temperature
- Second Stage Cooling Set Point Differential Temperature
- First Stage Heating Set Point Temperature
- Second Stage Heating Set Point Differential Temperature

Data points which can only be monitored:

- Inside Temperature - Current
- Outside Temperature - Current
- Outside Humidity - Current

- Dew point - Current
- Inside Temperature - Average Last Hour
- Outside Temperature - Average Last Hour
- Outside Humidity - Average Last Hour
- Dew point - Average Last Hour
- Unit 1 & Unit 2 Mechanical Cooling Time - Last Hour
- Unit 1 & Unit 2 Mechanical Cooling Requests - Last Hour
- Unit 1 & Unit 2 Free Air Cooling Time - Last Hour
- Unit 1 & Unit 2 Free Air Cooling Requests - Last Hour
- Unit 1 & Unit 2 Heating Time - Last Hour
- Unit 1 & Unit 2 Heating Requests - Last Hour

Dry Contacts Alarm Outputs



A dry contact is provided for each HVAC unit to indicate HVAC unit failure to the shelter alarm block. Unit failure is defined as 1) a high pressure lockout or 2) a low pressure lockout or 3) a loss of landline power. This dry contact is a normally open contact.

Back Panel Adapters for AVPA60 & AVHA60 Air Conditioners

These back panel adapters are factory installed on the non-economizer AVPA60 & AVHA60 ComPac air conditioners and to match the supply and return air openings on Marvair 2 and 3 ton air conditioners. This allows the AVPA60 & AVHA60 to be quickly and easily installed. No cutting or sawing of the shelter is required. The back panel, K/04317 has supply and return openings that match the openings of AVP24 & AVPA24 wall mounted air conditioners. The back panel, K/04315, has supply and return openings that match the openings of Marvair's AVP36 & AVPA36 air conditioners. In addition to matching the openings of Marvair units, the back panels will also match the openings of other brands.

When the K/04317 back panel adapter is used, a return filter grille, p/n 80671, must be used. When the K/04315 back panel adapter is used, a return filter grille, p/n 80672, must be used.

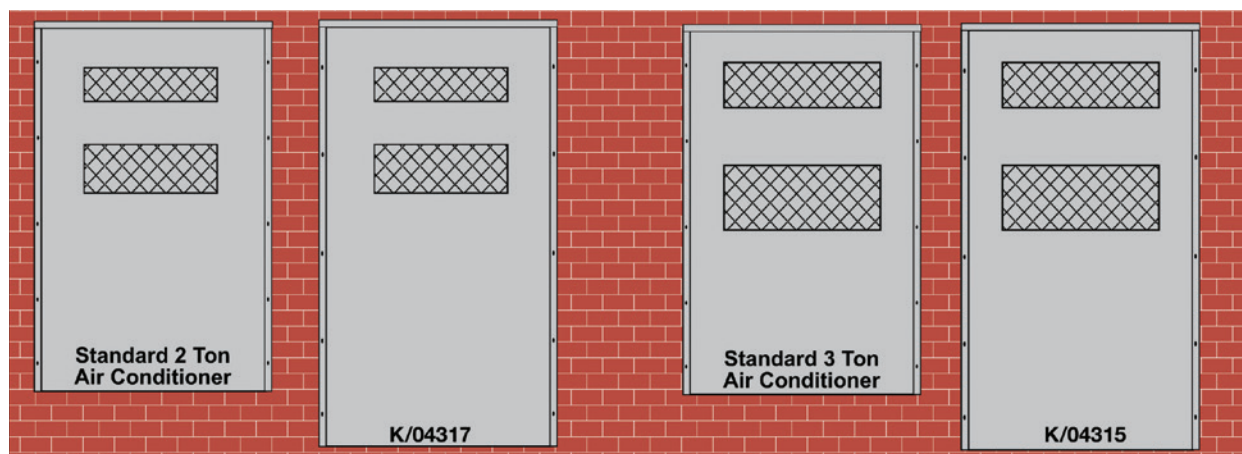

Control Box

The internal control board in the ComPac® air conditioners simplifies wiring, consolidates several of the electrical functions onto one device and improves the reliability of the air conditioner. In addition, the control board has LED's that indicate operational status and fault conditions.

► LED Indicator Lights

COLOR	TYPE	STATUS	DESCRIPTION
Green	Power	Constant On	24 VAC power has been applied
Red	Status	Constant On	Normal operation
		1 Blink	High pressure switch has opened twice
		2 Blinks	Low pressure switch has opened twice
		3 Blinks	Freeze stat (optional) - indoor coil temperature is below 35°F (1°C)

► Modes of Operation

Normal Start-up: On a call for cooling, and the with the high pressure switch closed, the cooling system (compressor, indoor blower motor and outdoor fan motor) will be energized. (Note: See the Delay on Make feature). The cooling system will remain energized during the three minute low pressure switch bypass cycle. If the low pressure is closed, the cooling system will continue to operate after the three-minute bypass. If the low pressure switch is open after the three-minute bypass, the cooling system will be de-energized.

Lockout Mode: If either the high or low pressure switch opens twice on the same call for cooling, the control board enters into and indicates the lockout mode. In the lockout mode, the compressor is turned off, the alarm output is energized and the status LED's will blink to indicate which fault has occurred. If there is a call for air flow, the indoor blower will remain energized. When the lockout condition has cleared, the unit will reset if the demand of the thermostat is removed or when power is reset. The lockout circuit is factory wired for normally open contacts. The user can select either normally closed or normally open remote alarm dry contacts.

Delay on Make: On initial power up or on resumption of power, the air conditioner will wait .03 to 10 minutes from a call for cooling before allowing the contactor to energize.

Model Identification

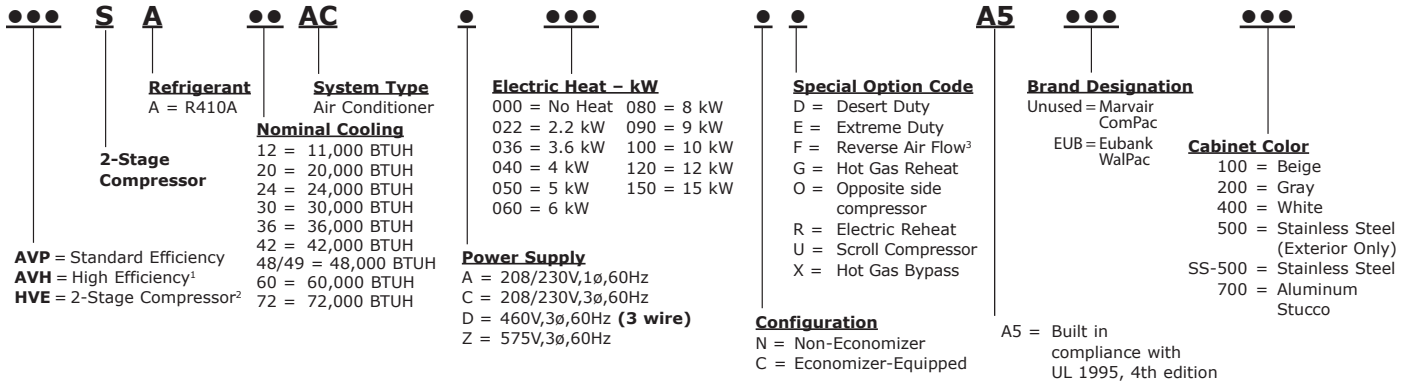

¹AVH models utilize a 1-Stage compressor, except the AVHSA72, which has a 2-Stage compressor as standard.

²All HVES models feature a 2-Stage compressor.

³The standard configuration is with the supply (conditioned) air at the top of the unit and the return air below it. In the reverse air flow configuration, the return is at the top and the supply air below it.

ComPac I & ComPac II Ambient Temperature Operating Ranges

Basic Model	Special Option	AVPA	AVHA/HVEA/HVESA/AVHSA
ComPac I (Non-Economizer)	Standard Unit (N)	20°F - 120°F (-7°C - 48.9°C)	20°F - 120°F (-7°C - 48.9°C)
	Desert Duty (ND)	20°F - 130°F (-7°C - 54°C)	20°F - 130°F (-7°C - 54°C)
	Extreme Duty Kit (NE)	0°F - 130°F (-18°C - 54°C)	0°F - 130°F (-18°C - 54°C)
ComPac II (Economizer-Equipped)	Standard Unit (C)	-40°F - 120°F (-40°C - 48.9°C)	-40°F - 120°F (-29°C - 48.9°C)
	Desert Duty (CD)	-40°F - 130°F (-40°F - 54°C)	-40°F - 130°F (-29°C - 54°C)
	Extreme Duty Kit (CE)	-40°F - 130°F (-40°F - 54°C)	-40°F - 130°F (-29°C - 54°C)

EER Comparison by Model

Nominal Cooling Capacity (BTUH)	Basic Model	EER	Nominal Cooling Capacity (BTUH)	Basic Model	EER	
12,000	AVPA12	9.00	42,000	AVPA42	9.25	
	AVHA12	10.00		AVHA42	10.00	
20,000	AVPA20	9.00		HVEA42	10.50	
	AVHA20	10.00		HVESA42	10.50	
24,000	AVPA24	9.25		48,000	AVPA48	9.50
	AVHA24	10.00			AVHA48	10.00
	HVEA24	10.75	HVEA49		11.50	
30,000	AVPA30	9.25	HVESA49	11.50		
	AVHA30	10.00	60,000	AVPA60	9.25	
36,000	HVEA30	11.75		AVHA60	10.00	
	AVPA36	9.25		HVEA60	10.50	
36,000	AVHA36	10.00	HVESA60	11.00		
	HVEA36	11.25	72,000	AVPA72	10.00	
				AVHSA72	11.00	
	HVESA36	11.25				

Note: HVESA models have 2-stage compressors.

ComPac® AVPA Standard Efficiency Air Conditioners

Certified Efficiency and Capacity Ratings at ANSI/AHRI Standard 390 - AVPA/AVHA Air Conditioners



Model Number	AVPA12	AVPA20	AVPA24				AVPA30				AVPA36				AVPA42				AVPA48				AVPA60				AVPA72							
	ACA	ACA	ACA	ACC	ACD	ACZ	ACA	ACC	ACD	ACZ	ACA	ACC	ACD	ACZ	ACA	ACC	ACD	ACZ	ACA	ACC	ACD	ACZ	ACA	ACC	ACD	ACZ	ACA	ACC	ACD	ACZ	ACA	ACC	ACD	ACZ
Cooling BTUH ¹	10,800	19,600	24,000				29,000				35,000				42,000				46,000				54,500				62,000				70,000			
EER ²	9.00	9.00	9.25				9.25				9.25				9.25				9.50				9.25				10.00				10.00			
Rated Air Flow (CFM ³)	400	755	840				1,000				1,100				1,575				1,725				1,850				1,925				1,925			

Model Number	AVHA12	AVHA20	AVHA24				AVHA30				AVHA36				AVHA42				AVHA48				AVHA60						
	ACA	ACA	ACA	ACC	ACD	ACZ	ACA	ACC	ACD	ACZ	ACA	ACC	ACD	ACZ	ACA	ACC	ACD	ACZ	ACA	ACC	ACD	ACZ	ACA	ACC	ACD	ACZ	ACA	ACC	ACD
Cooling BTUH ¹	10,800	19,600	24,000				29,000				33,000				42,000				46,000				54,000						
EER ²	10.00	10.00	10.00				10.00				10.00				10.00				10.00				10.00						
Rated Air Flow (CFM ³)	400	755	840				1,000				1,100				1,575				1,725				1,850						

¹Cooling rated at 95°F (35°C) outdoor and 80°F DB/67° WB (26.5°C DB/19.5°C WB) return air. ²EER=Energy Efficiency Ratio ³CFM=Cubic Feet per Minute
Ratings are with no outside air. Performance will be affected by altitude.
Ratings are at 230 volts for 208/230 volt units ("A" & "C" models) and 460 volts for "D" models. Operation of units at a different voltage from that of the rating point will affect performance and air flow.

Sensible Total Heat Ratio @ 95°F (35°C) Outside Air Dry Bulb - AVPA/AVHA Air Conditioners

Model Number	AVPA12	AVPA20	AVPA24				AVPA30				AVPA36				AVPA42				AVPA48				AVPA60				AVPA72							
	ACA	ACA	ACA	ACC	ACD	ACZ	ACA	ACC	ACD	ACZ	ACA	ACC	ACD	ACZ	ACA	ACC	ACD	ACZ	ACA	ACC	ACD	ACZ	ACA	ACC	ACD	ACZ	ACA	ACC	ACD	ACZ	ACA	ACC	ACD	ACZ
Total Capacity	10,800	19,600	24,000				29,000				35,000				42,000				46,000				54,500				62,000				70,000			
Sensible Heat Ratio	0.74	0.76	0.75				0.75				0.69				0.76				0.76				0.73				0.71				0.67			
Sensible Capacity	8,000	14,800	18,000				21,740				24,155				31,900				34,940				39,800				43,815				46,800			
Rated Air Flow (CFM ¹)	400	755	840				1,000				1,100				1,575				1,725				1,850				1,925				1,925			

Model Number	AVHA12	AVHA20	AVHA24				AVHA30				AVHA36				AVHA42				AVHA48				AVHA60						
	ACA	ACA	ACA	ACC	ACD	ACZ	ACA	ACC	ACD	ACZ	ACA	ACC	ACD	ACZ	ACA	ACC	ACD	ACZ	ACA	ACC	ACD	ACZ	ACA	ACC	ACD	ACZ	ACA	ACC	ACD
Total Capacity	10,800	19,600	24,000				29,000				33,000				42,000				46,000				54,000						
Sensible Heat Ratio	0.74	0.76	0.75				0.75				0.74				0.74				0.76				0.72						
Sensible Capacity	8,000	14,800	18,000				21,700				24,500				31,000				35,000				39,000						
Rated Air Flow (CFM ¹)	400	755	840				1,000				1,100				1,575				1,725				1,850						

¹CFM=Cubic Feet per Minute. Sensible heat ratios based upon ANSI/AHRI std. 390 outdoor air conditions of 95°F (35°C) and 80°F DB/67° WB (26.5°C DB/19.5°C WB) return air.

Electrical Characteristics - Compressor, Fan & Blower Motors - AVPA/AVHA Air Conditioner

BASIC MODEL	COMPRESSOR				OUTDOOR FAN & INDOOR BLOWER MOTORS	OUTDOOR FAN MOTOR			INDOOR BLOWER MOTOR		
	TYPE	VOLTS / HZ / PH	RLA ¹	LRA ²	VOLTS / HZ / PH	RPM ³	FLA ⁴	HP ⁵	RPM ³	FLA ⁴	HP ⁵
AVPA/AVHA12ACA	ROTARY	208/230-60-1	4.7	25.0	208/230-60-1	1630	0.65	1/6	1650	0.85	1/5
AVPA/AVHA20ACA	SCROLL	208/230-60-1	10.9	62.9	208/230-60-1	1075	1.5	1/5	1075	1.5	1/5
AVPA/AVHA24ACA		208/230-60-1	12.8	64.0	208/230-60-1	1075	1.5	1/5	1075	1.5	1/5
AVPA/AVHA30ACA		208/230-60-1	14.1	77.0	208/230-60-1	1075	1.8	1/4	1075	2.5	1/4
AVPA/AVHA36ACA		208/230-60-1	17.9	112.0	208/230-60-1	1075	1.8	1/4	1075	2.5	1/4
AVPA/AVHA42ACA		208/230-60-1	19.8	109.0	208/230-60-1	825	2.8	1/3	1075	3.1	1/2
AVPA/AVHA48ACA		208/230-60-1	21.8	117.0	208/230-60-1	825	2.8	1/3	1075	3.1	1/2
AVPA/AVHA60ACA		208/230-60-1	26.2	134.0	208/230-60-1	825	2.8	1/3	1075	5.2	3/4
AVPA72ACA		208/230-60-1	30.1	158.0	208/230-60-1	825	2.9	1/2	1075	5.2	3/4
AVPA/AVHA24ACC		SCROLL	208/230-60-3	8.3	61.0	208/230-60-1	1075	1.5	1/5	1075	1.5
AVPA/AVHA30ACC	208/230-60-3		9.0	71.0	208/230-60-1	1075	1.8	1/4	1075	2.5	1/4
AVPA/AVHA36ACC	208/230-60-3		13.2	88.0	208/230-60-1	1075	1.8	1/4	1075	2.5	1/4
AVPA/AVHA42ACC	208/230-60-3		13.6	83.1	208/230-60-1	825	2.8	1/3	1075	3.1	1/2
AVPA/AVHA48ACC	208/230-60-3		13.7	83.1	208/230-60-1	825	2.8	1/3	1075	3.1	1/2
AVPA/AVHA60ACC	208/230-60-3		15.6	111.0	208/230-60-1	825	2.8	1/3	1075	5.2	3/4
AVPA72ACC	208/230-60-3		22.4	149.0	208/230-60-1	825	2.9	1/2	1075	5.2	3/4
AVPA/AVHA24ACD	SCROLL	460-60-3	5.1	28.0	208/230-60-1	1075	1.5	1/5	1075	1.5	1/5
AVPA/AVHA30ACD		460-60-3	5.6	38.0	208/230-60-1	1075	1.8	1/4	1075	2.5	1/4
AVPA/AVHA36ACD		460-60-3	6.0	44.0	208/230-60-1	1075	1.8	1/4	1075	2.5	1/4
AVPA/AVHA42ACD		460-60-3	6.1	41.0	208/230-60-1	825	2.8	1/3	1075	3.1	1/2
AVPA/AVHA48ACD		460-60-3	6.2	41.0	208/230-60-1	825	2.8	1/3	1075	3.1	1/2
AVPA/AVHA60ACD		460-60-3	7.7	52.0	208/230-60-1	825	2.8	1/3	1075	5.2	3/4
AVPA72ACD		460-60-3	10.6	75.0	208/230-60-1	825	2.9	1/2	1075	5.2	3/4
AVPA24ACZ	SCROLL	575-60-3	3.3	23.7	208/230-60-1	1075	1.5	1/5	1075	1.5	1/5
AVPA30ACZ		575-60-3	3.8	36.5	208/230-60-1	1075	1.5	1/5	1075	1.5	1/4
AVPA36ACZ		575-60-3	4.2	30.0	208/230-60-1	1075	1.8	1/4	1075	2.5	1/4
AVPA42ACZ		575-60-3	4.2	33.0	208/230-60-1	1075	1.8	1/4	1075	2.5	1/2
AVPA48ACZ		575-60-3	4.8	33.0	208/230-60-1	825	2.8	1/3	1075	3.1	1/2
AVPA60ACZ		575-60-3	5.8	38.9	208/230-60-1	825	2.8	1/3	1075	3.1	3/4
AVPA72ACZ		575-60-3	7.7	54.0	208/230-60-1	825	2.8	1/3	1075	5.2	3/4

¹RLA = Rated Load Amps ²LRA = Locked Rotor Amps ³RPM = Revolutions per Minute ⁴FLA = Full Load Amps ⁵HP = Horsepower
The 460 volt (ACD) units will have a step down transformer for the 230 volt motors.

**Summary Electrical Ratings (Wire and Circuit Breaker Sizing) -
 AVPA/AVHA Air Conditioners with Ventilation Configurations:
 Manual Damper, up to 15% Outside Air ("N"),
 Economizer, Outside Air with Pressure Relief ("C")**

ELECTRIC HEAT		000 = None		022 = 2.2 kw		036 = 3.6 kw		040 = 4 kw		050 = 5 kw		060 = 6 kw		080 = 8 kw		090 = 9 kw		100 = 10 kw		120 = 12 kw		150 = 15 kw	
BASIC MODEL	VOLTAGE PHASE / HZ	SPPE ³		SPPE ³		SPPE ³		SPPE ³		SPPE ³		SPPE ³		SPPE ³		SPPE ³		SPPE ³		SPPE ³		SPPE ³	
		MCA ¹	MFS ²	MCA ¹	MFS ²	MCA ¹	MFS ²	MCA ¹	MFS ²	MCA ¹	MFS ²	MCA ¹	MFS ²	MCA ¹	MFS ²	MCA ¹	MFS ²	MCA ¹	MFS ²	MCA ¹	MFS ²	MCA ¹	MFS ²
AVPA/AVHA12ACA	208/230-1-60	7.4	15	12.4	15	19.7	20			26.9	30												
AVPA/AVHA20ACA	208/230-1-60	15.6	25					22.4	25	27.5	30	32.8	35	43.1	45			53.6	60				
AVPA/AVHA24ACA	208/230-1-60	19.0	30					22.4	30	27.5	30	32.8	35	43.1	45			53.6	60				
AVPA/AVHA30ACA	208/230-1-60	21.9	35					23.4	35	28.5	35	33.8	35	44.1	45			54.6	60	65.0	70	80.6	90
AVPA/AVHA36ACA	208/230-1-60	26.7	40					26.7	40	28.5	40	33.8	40	44.1	45			54.6	60	65.0	70	80.6	90
AVPA/AVHA42ACA	208/230-1-60	30.7	50							30.7	50							55.2	60	65.6	70	81.2	90
AVPA/AVHA48ACA	208/230-1-60	33.2	50							33.2	50							55.2	60	65.6	70	81.2	90
AVPA/AVHA60ACA	208/230-1-60	40.8	60							40.8	60							57.3	60	67.7	70	83.3	90
AVPA72ACA	208/230-1-60	45.6	60							45.6	60							57.3	60	67.7	70	83.3	90
AVPA/AVHA24ACC	208/230-3-60	13.4	20									19.5	20			28.6	30			37.6	40		
AVPA/AVHA30ACC	208/230-3-60	15.6	20									20.5	25			29.6	30			38.6	40	47.6	50
AVPA/AVHA36ACC	208/230-3-60	20.8	30									20.8	30			29.6	30			38.6	40	47.6	50
AVPA/AVHA42ACC	208/230-3-60	22.9	35									22.9	35			30.2	35			39.1	40	48.1	50
AVPA/AVHA48ACC	208/230-3-60	23.0	35									23.0	35			30.2	35			39.1	40	48.1	50
AVPA/AVHA60ACC	208/230-3-60	27.5	40									27.5	40			32.3	40			41.3	45	50.2	60
AVPA72ACC	208/230-3-60	36.1	50									36.1	50			36.1	50			41.3	50	50.2	60
AVPA/AVHA24ACD	460-3-60	7.9	15									9.8	15			14.3	15			18.8	20	23.3	25
AVPA/AVHA30ACD	460-3-60	9.2	15									10.3	15			14.8	15			19.3	20	23.8	25
AVPA/AVHA36ACD	460-3-60	9.7	15									10.3	15			14.8	15			19.3	20	23.8	25
AVPA/AVHA42ACD	460-3-60	10.6	15									10.9	15			15.1	20			19.6	20	24.1	25
AVPA/AVHA48ACD	460-3-60	10.7	15									10.9	15			15.1	20			19.6	20	24.1	25
AVPA/AVHA60ACD	460-3-60	13.6	20									13.6	20			16.1	20			20.6	25	25.1	30
AVPA72ACD	460-3-60	17.3	25									17.3	25			17.3	25			20.6	25	25.1	30
AVPA24ACZ	575-3-60	5.3	15									7.9	15			11.5	15			15.0	16		
AVPA30ACZ	575-3-60	6.5	15									8.3	15			11.9	15			15.4	20	19.0	20
AVPA36ACZ	575-3-60	7.0	15									8.3	15			11.9	15			15.4	20	19.0	20
AVPA42ACZ	575-3-60	7.6	15									8.5	15			12.1	15			16.6	20	19.2	20
AVPA48ACZ	575-3-60	8.4	15									8.5	15			12.1	15			16.6	20	19.2	20
AVPA60ACZ	575-3-60	10.5	15									10.5	15			13.0	15			16.5	20	20.1	25
AVPA72ACZ	575-3-60	12.8	20									12.8	20			13.0	20			16.5	20	20.1	25

¹MCA = Minimum Circuit Ampacity (Wiring Size Amps) ²MFS = Maximum Fuse or HACR Breaker Size ³SPPE = Single Point Power Entry
 MCA & MFS are calculated at 230 volts on the ACA & ACC models. The 460 volts ACD models are calculated at 460 volts. This chart should only be used as a guideline for estimating conductor size and overcurrent protection. For the requirements of specific units, always refer to the data label on the unit.

Summary Electrical Ratings (Wire and Circuit Breaker Sizing) - AVPA/AVHA Air Conditioners with Elec. Reheat ("R") and Ventilation Configurations: Manual Damper, up to 15% Outside Air ("N"), Economizer, Outside Air with Pressure Relief ("C")

ELECTRIC HEAT		000 = None		022 = 2.2 kw		036 = 3.6 kw		040 = 4 kw		050 = 5 kw		060 = 6 kw		080 = 8 kw		090 = 9 kw		100 = 10 kw		120 = 12 kw		150 = 15 kw	
BASIC MODEL	VOLTAGE PHASE / HZ	SPPE ³		SPPE ³		SPPE ³		SPPE ³		SPPE ³		SPPE ³		SPPE ³		SPPE ³		SPPE ³		SPPE ³		SPPE ³	
		MCA ¹	MFS ²	MCA ¹	MFS ²	MCA ¹	MFS ²	MCA ¹	MFS ²	MCA ¹	MFS ²	MCA ¹	MFS ²	MCA ¹	MFS ²	MCA ¹	MFS ²	MCA ¹	MFS ²	MCA ¹	MFS ²	MCA ¹	MFS ²
AVPA/AVHA12ACA	208/230-1-60	7.4	15	18.9	20	26.2	30			33.4	35												
AVPA/AVHA20ACA	208/230-1-60	15.6	25					36.5	40	41.6	50	46.9	50					67.7	70				
AVPA/AVHA24ACA	208/230-1-60	19.0	30					39.9	40	45	45	50.3	60					71.1	80				
AVPA/AVHA30ACA	208/230-1-60	21.9	35					42.8	45	47.9	50	53.2	60					74	80	84.8	90	100	100
AVPA/AVHA36ACA	208/230-1-60	26.7	40					47.6	50	52.7	60	58	60					78.8	80	89.2	90	104.8	110
AVPA/AVHA42ACA	208/230-1-60	30.7	50							56.7	60							82.8	90	93.2	100	108.8	110
AVPA/AVHA48ACA	208/230-1-60	33.2	50							59.2	60							85.3	90	95.7	100	111.3	120
AVPA/AVHA60ACA	208/230-1-60	40.8	60							66.8	70							92.9	100	103.3	110	118.9	120
AVPA72ACA	208/230-1-60	45.6	60							71.6	80							97.7	100	108.1	110	123.7	130
AVPA/AVHA24ACC	208/230-3-60	13.4	20									31.4	35			40.5	45			49.5	50	58.5	60
AVPA/AVHA30ACC	208/230-3-60	15.6	20									33.6	35			42.7	45			51.7	60	60.7	70
AVPA/AVHA36ACC	208/230-3-60	20.8	30									38.8	40			47.9	50			56.9	60	65.9	70
AVPA/AVHA42ACC	208/230-3-60	22.9	35									40.9	45			50.0	50			59.0	60	68.0	70
AVPA/AVHA48ACC	208/230-3-60	23.0	35									41.0	45			50.1	60			59.1	60	68.1	70
AVPA/AVHA60ACC	208/230-3-60	27.5	40									45.5	50			54.6	60			63.6	70	72.6	80
AVPA72ACC	208/230-3-60	36.1	50									54.1	60			63.2	70			72.2	80	81.2	90
AVPA/AVHA24ACD	460-3-60	7.9	15									16.9	20			21.4	25			25.9	30	30.4	35
AVPA/AVHA30ACD	460-3-60	9.2	15									18.2	20			22.7	25			27.2	30	31.7	35
AVPA/AVHA36ACD	460-3-60	9.7	15									18.7	20			23.2	25			27.7	30	32.2	35
AVPA/AVHA42ACD	460-3-60	10.6	15									19.6	20			24.1	25			28.6	30	33.1	35
AVPA/AVHA48ACD	460-3-60	10.7	15									19.7	20			24.2	25			28.7	30	33.2	35
AVPA/AVHA60ACD	460-3-60	13.6	20									22.6	25			27.1	30			31.6	35	36.1	40
AVPA72ACD	460-3-60	17.3	25									26.3	30			30.8	35			35.3	40	39.8	40
AVPA24ACZ	575-3-60	5.3	15									12.6	15			16.2	20			19.7	20		
AVPA30ACZ	575-3-60	6.5	15									13.7	15			17.3	20			20.8	25	24.5	25
AVPA36ACZ	575-3-60	7.0	15									14.2	15			17.8	20			21.3	25	25.0	25
AVPA42ACZ	575-3-60	7.6	15									14.9	16			18.5	20			22.0	25	25.6	30
AVPA48ACZ	575-3-60	8.4	15									15.6	20			19.2	20			22.7	25	26.4	30
AVPA60ACZ	575-3-60	10.5	15									17.7	20			21.3	25			24.8	25	28.5	30
AVPA72ACZ	575-3-60	12.8	20									20.1	25			23.7	25			27.2	30	30.8	35

¹MCA = Minimum Circuit Ampacity (Wiring Size Amps) ²MFS = Maximum Fuse or HACR Breaker Size ³SPPE = Single Point Power Entry
MCA & MFS are calculated at 230 volts on the ACA & ACC models. The 460 volts ACD models are calculated at 460 volts. This chart should only be used as a guideline for estimating conductor size and overcurrent protection. For the requirements of specific units, always refer to the data label on the unit.

Unit Load Amps - AVPA/AVHA Air Conditioners with Ventilation Configurations: Manual Damper, up to 15% Outside Air ("N") Economizer, Outside Air with Pressure Relief ("C")

BASIC MODEL NUMBER	VOLTAGE PHASE / HZ	CUR-RENT AMPS		LOAD OF RESISTIVE HEATING - ELEMENTS ONLY (AMPS)										TOTAL MAXIMUM HEATING AMPS									
				(1) ALL HEATING ELEMENTS ARE ON A SEPARATE CIRCUIT										INCLUDES AMPS FROM MOTOR(S) THAT ARE LOCATED ON AN ELECTRICAL CIRCUIT THAT DOES NOT HAVE HEATERS									
				(2) SHADED VALUES (12 & 15 kW) UTILIZE TWO CIRCUITS																			
AC ¹	IBM ²	2.2 kW	3.6 kW	04 kW	05 kW	06 kW	08 kW	09 kW	10 kW	12 kW	15 kW	2.2 kW	3.6 kW	04 kW	05 kW	06 kW	08 kW	09 kW	10 kW	12 kW	15 kW		
AVPA/AVHA12ACA	208/230-1-60	6.1	0.85	9.2	15.0		20.8							10.1	15.0		21.7						
AVPA/AVHA20ACA	208/230-1-60	13.9	1.5			16.7	20.8	25.0	33.3		41.7					18.2	22.3	26.5	34.8		43.2		
AVPA/AVHA24ACA	208/230-1-60	15.8	1.5			16.7	20.8	25.0	33.3		41.7					18.2	22.3	26.5	34.8		43.2		
AVPA/AVHA30ACA	208/230-1-60	18.4	2.5			16.7	20.8	25.0	33.3		41.7	50.0	62.5			19.2	23.3	27.5	35.8		44.2	52.5 65.0	
AVPA/AVHA36ACA	208/230-1-60	22.2	2.5			16.7	20.8	25.0	33.3		41.7	50.0	62.5			19.2	23.3	27.5	35.8		44.2	52.5 65.0	
AVPA/AVHA42ACA	208/230-1-60	25.7	3.1				20.8				41.7	50.0	62.5			23.9					44.8	53.1 65.6	
AVPA/AVHA48ACA	208/230-1-60	27.7	3.1				20.8				41.7	50.0	62.5			23.9					44.8	53.1 65.6	
AVPA/AVHA60ACA	208/230-1-60	34.2	5.2				20.8				41.7	50.0	62.5			26.0					46.9	55.2 67.7	
AVPA72ACA	208/230-1-60	38.2	5.2				20.8				41.7	50.0	62.5			26.0					46.9	55.2 67.7	
AVPA/AVHA24ACC	208/230-3-60	11.2	1.5					14.4	21.7		28.9	36.1				15.9		23.2			30.4	37.6	
AVPA/AVHA30ACC	208/230-3-60	13.3	2.5					14.4	21.7		28.9	36.1				16.9		24.2			31.4	38.6	
AVPA/AVHA36ACC	208/230-3-60	17.5	2.5					14.4	21.7		28.9	36.1				16.9		24.2			31.4	38.6	
AVPA/AVHA42ACC	208/230-3-60	19.5	3.1					14.4	21.7		28.9	36.1				17.5		24.8			32.0	39.2	
AVPA/AVHA48ACC	208/230-3-60	19.6	3.1					14.4	21.7		28.9	36.1				17.5		24.8			32.0	39.2	
AVPA/AVHA60ACC	208/230-3-60	23.6	5.2					14.4	21.7		28.9	36.1				19.6		26.9			34.1	41.3	
AVPA72ACC	208/230-3-60	30.5	5.2					14.4	21.7		28.9	36.1				19.6		26.9			34.1	41.3	
AVPA/AVHA24ACD	460-3-60	6.6	0.8					7.2	10.8		14.4	18.0				8.0		11.6			15.2	18.8	
AVPA/AVHA30ACD	460-3-60	7.8	1.3					7.2	10.8		14.4	18.0				8.5		12.1			15.7	19.3	
AVPA/AVHA36ACD	460-3-60	8.2	1.3					7.2	10.8		14.4	18.0				8.5		12.1			15.7	19.3	
AVPA/AVHA42ACD	460-3-60	9.1	1.6					7.2	10.8		14.4	18.0				8.8		12.4			16.0	19.6	
AVPA/AVHA48ACD	460-3-60	9.2	1.6					7.2	10.8		14.4	18.0				8.8		12.4			16.0	19.6	
AVPA/AVHA60ACD	460-3-60	11.7	2.6					7.2	10.8		14.4	18.0				9.8		13.4			17.0	20.6	
AVPA72ACD	460-3-60	14.7	2.6					7.2	10.8		14.4	18.0				9.8		13.4			17.0	20.6	
AVPA24ACZ	575-3-60	4.5	0.6					5.8	8.7		11.5					6.4		9.3			12.1		
AVPA30ACZ	575-3-60	5.5	1.0					5.8	8.7		11.5	14.4				6.8		9.7			12.5	15.4	
AVPA36ACZ	575-3-60	5.9	1.0					5.8	8.7		11.5	14.4				6.8		9.7			12.5	15.4	
AVPA42ACZ	575-3-60	6.6	1.2					5.8	8.7		11.5	14.4				7.0		9.9			12.7	15.6	
AVPA48ACZ	575-3-60	7.2	1.2					5.8	8.7		11.5	14.4				7.0		9.9			12.7	15.6	
AVPA60ACZ	575-3-60	9.0	2.1					5.8	8.7		11.5	14.4				7.9		10.8			13.6	16.5	
AVPA72ACZ	575-3-60	10.9	2.1					5.8	8.7		11.5	14.4				7.9		10.8			13.6	16.5	

¹AC = Air Conditioner Unit Amps ²IBM = Indoor Blower Motor
 Heating kW is rated at 240 volts on the ACA & ACC models. Derate heater output by 25% for operation at 208 volts. Heating kW is rated at 480 volts on the ACD models. Total heating and cooling amps includes all motors. Three phase models contain single phase motor loads. Loads are not equally balanced on each phase and values shown are maximum phase loads.

ComPac® HVEA High Efficiency Air Conditioners

Certified Efficiency and Capacity Ratings at ANSI/AHRI Standard 390 for HVEA Air Conditioners with Single Stage Compressor



Model Number	HVEA24			HVEA30			HVEA36			HVEA42			HVEA49			HVEA60		
	ACA	ACC	ACD	ACA	ACC	ACD	ACA	ACC	ACD	ACA	ACC	ACD	ACA	ACC	ACD	ACA	ACC	ACD
Cooling BTUH ¹	23,600			29,000			35,600			40,000			49,000			58,000		
EER ²	10.75			11.75			11.25			10.50			11.50			10.50		
Rated Air Flow (CFM ³)	800			1,000			1,300			1,400			1,750			1,900		

¹Cooling rated at 95°F (35°C) outdoor and 80°F DB/67° WB (26.5°C DB/19.5°C WB) return air ²EER=Energy Efficiency Ratio ³CFM=Cubic Feet per Minute
Ratings are with no outside air. Performance will be affected by altitude.
Ratings are at 230 volts for 208/230 volt units ("A" & "C" models) and 460 volts for "D" models. Operation of units at a different voltage from that of the rating point will affect performance and air flow.

Sensible Total Heat Ratio @ 95°F (35°C) Outside Air Dry Bulb - HVEA Air Conditioners with Single Stage Compressor

Model Number	HVEA24			HVEA30			HVEA36			HVEA42			HVEA49			HVEA60		
	ACA	ACC	ACD	ACA	ACC	ACD	ACA	ACC	ACD	ACA	ACC	ACD	ACA	ACC	ACD	ACA	ACC	ACD
Total Capacity	23,600			29,000			35,600			40,000			49,000			58,000		
Sensible Heat Ratio	0.74			0.76			0.76			0.73			0.74			0.73		
Sensible Capacity	17,435			22,020			26,945			29,270			36,175			42,505		
Rated Air Flow (CFM ¹)	800			1,000			1,300			1,400			1,750			1,900		

¹CFM=Cubic Feet per Minute
Sensible heat ratios based upon ANSI/AHRI std. 390 outdoor air conditions of 95°F (35°C) and 80°F DB/67° WB (26.5°C DB/19.5°C WB) return air.

Cooling Performance (BTUH) at Various Outdoor Temperatures for HVEA Air Conditioners with Single Stage Compressor

Model Number	Outdoor Temperature											
	75°F / 24°C	80°F / 26.5°C	85°F / 29°C	90°F / 32°C	95°F / 35°C	100°F / 38°C	105°F / 40.5°C	110°F / 43.3°C	115°F / 46.1°C	120°F / 48.9°C	125°F / 51.7°C	130°F / 54.4°C
HVEA24AC	27,375	26,430	25,490	24,545	23,600	22,655	21,710	20,770	20,295	19,870	19,445	19,020
HVEA30AC	33,640	32,480	31,320	30,160	29,000	27,840	26,680	25,520	24,940	24,420	23,895	23,375
HVEA36AC	41,295	39,870	38,450	37,025	35,600	34,175	32,750	31,320	30,615	29,975	29,335	28,695
HVEA42AC	46,400	44,800	43,200	41,600	40,000	38,400	36,800	35,200	34,400	33,680	32,960	32,240
HVEA49AC	56,840	54,880	52,920	50,960	49,000	47,040	45,080	43,120	42,140	41,260	40,375	39,495
HVEA60AC	67,280	64,960	62,640	60,320	58,000	55,680	53,360	51,040	49,880	48,835	47,790	46,745

Based upon ANSI/AHRI std. 390 return air conditions of 80°F DB/67° WB (26.5°C DB/19.5°C WB) at various outdoor temperatures.

Electrical Characteristics - Compressor, Fan & Blower Motors - HVEA Air Conditioner with Single Stage Compressor

BASIC MODEL	COMPRESSOR				OUTDOOR FAN MOTOR				INDOOR FAN MOTOR (ECM)			
	Type	VOLTS-HZ-PH	RLA ¹	LRA ²	VOLTS-HZ-PH	RPM ³	FLA ⁴	HP ⁵	VOLTS-HZ-PH	RPM ³	FLA ⁴	HP ⁵
HVEA24ACA	SCROLL	208/230-60-1	12.8	58.3	208/230-60-1	1075	1.8	1/4	208/230-60-1	1500	2.8	1/3
HVEA30ACA		208/230-60-1	12.8	64.0	208/230-60-1	825	2.8	1/3	208/230-60-1	1500	2.8	1/2
HVEA36ACA		208/230-60-1	16.6	79.0	208/230-60-1	825	2.8	1/3	208/230-60-1	1500	2.8	1/2
HVEA42ACA		208/230-60-1	19.8	109.0	208/230-60-1	825	2.8	1/3	208/230-60-1	1500	2.8	1/2
HVEA49ACA		208/230-60-1	21.8	117.0	208/230-60-1	825	2.8	1/2	208/230-60-1	1500	4.3	3/4
HVEA60ACA		208/230-60-1	26.4	134.0	208/230-60-1	825	2.8	1/2	208/230-60-1	1500	4.3	3/4
HVEA24ACC	SCROLL	208/230-60-3	7.7	55.4	208/230-60-1	1075	1.8	1/4	208/230-60-1	1500	2.8	1/3
HVEA30ACC		208/230-60-3	8.3	61.0	208/230-60-1	825	2.8	1/3	208/230-60-1	1500	2.8	1/2
HVEA36ACC		208/230-60-3	10.4	88.0	208/230-60-1	825	2.8	1/3	208/230-60-1	1500	2.8	1/2
HVEA42ACC		208/230-60-3	13.6	83.1	208/230-60-1	825	2.8	1/3	208/230-60-1	1500	2.8	1/2
HVEA49ACC		208/230-60-3	13.7	83.1	208/230-60-1	825	2.8	1/2	208/230-60-1	1500	4.3	3/4
HVEA60ACC		208/230-60-3	15.9	111.0	208/230-60-1	825	2.8	1/2	208/230-60-1	1500	4.3	3/4
HVEA24ACD	SCROLL	460-60-3	4.0	28.0	208/230-60-1	1075	1.8	1/4	208/230-60-1	1500	2.8	1/3
HVEA30ACD		460-60-3	5.1	28.0	208/230-60-1	825	2.8	1/3	208/230-60-1	1500	2.8	1/2
HVEA36ACD		460-60-3	5.8	38.0	208/230-60-1	825	2.8	1/3	208/230-60-1	1500	2.8	1/2
HVEA42ACD		460-60-3	6.1	41.0	208/230-60-1	825	2.8	1/3	208/230-60-1	1500	2.8	1/2
HVEA49ACD		460-60-3	6.2	41.0	208/230-60-1	825	2.8	1/2	208/230-60-1	1500	4.3	3/4
HVEA60ACD		460-60-3	7.7	52.0	208/230-60-1	825	2.8	1/2	208/230-60-1	1500	4.3	3/4

¹RLA = Rated Load Amps ²LRA = Locked Rotor Amps ³RPM = Revolutions per Minute ⁴FLA = Full Load Amps ⁵HP = Horsepower
The 460 volt units will have a step down transformer for the 230 volt motors.

Summary Electrical Ratings (Wire and Circuit Breaker Sizing) - HVEA Air Conditioners with Single stage Compressors & Ventilation Configurations: Manual Damper, up to 15% Outside Air ("N") Economizer, Outside Air with Pressure Relief ("C")

ELECTRIC HEAT		000 = None		040 = 4 kw		050 = 5 kw		060 = 6 kw		080 = 8 kw		090 = 9 kw		100 = 10 kw		120 = 12 kw		150 = 15 kw	
BASIC MODEL	VOLTAGE PHASE / HZ	SPPE ³		SPPE ³		SPPE ³		SPPE ³		SPPE ³		SPPE ³		SPPE ³		SPPE ³		SPPE ³	
		MCA ¹	MFS ²	MCA ¹	MFS ²	MCA ¹	MFS ²	MCA ¹	MFS ²	MCA ¹	MFS ²	MCA ¹	MFS ²	MCA ¹	MFS ²	MCA ¹	MFS ²	MCA ¹	MFS ²
HVEA24ACA	208/230-1-60	20.6	30	23.1	30	28.8	30	34.1	35	44.4	45			54.9	60				
HVEA30ACA	208/230-1-60	21.6	30	23.1	30	28.8	30	34.1	35	44.4	45			54.9	60	65.3	70	80.9	90
HVEA36ACA	208/230-1-60	26.4	40	26.4	40	28.8	40	34.1	35	44.4	45			54.9	60	65.3	70	80.9	90
HVEA42ACA	208/230-1-60	30.4	50	30.4	50	30.4	50							54.9	60	65.3	70	80.9	90
HVEA49ACA	208/230-1-60	34.4	50			34.4	50							56.4	60	66.8	70	82.4	90
HVEA60ACA	208/230-1-60	40.1	60			40.1	60							56.4	60	66.8	70	82.4	90
HVEA24ACC	208/230-3-60	14.2	20					20.8	25			29.9	30			38.9	40		
HVEA30ACC	208/230-3-60	16.0	20					20.8	25			29.9	30			38.9	40	47.9	50
HVEA36ACC	208/230-3-60	18.6	25					20.8	25			29.9	30			38.9	40	47.9	50
HVEA42ACC	208/230-3-60	22.6	35					22.6	35			29.9	35			38.9	40	47.9	50
HVEA49ACC	208/230-3-60	24.2	35					24.2	35			31.4	35			40.4	50	49.4	50
HVEA60ACC	208/230-3-60	27.0	40					27.0	40			31.4	40			40.4	50	49.4	50
HVEA24ACD	460-3-60	7.3	15					10.4	15			14.9	15			19.4	20	23.9	25
HVEA30ACD	460-3-60	9.2	15					10.4	15			14.9	15			19.4	20	23.9	25
HVEA36ACD	460-3-60	10.1	15					10.4	15			14.9	15			19.4	20	23.9	25
HVEA42ACD	460-3-60	10.4	15					10.4	15			14.9	15			19.4	20	23.9	25
HVEA49ACD	460-3-60	11.3	15					11.3	15			15.7	20			20.2	25	24.7	25
HVEA60ACD	460-3-60	13.2	20					13.2	20			15.7	20			20.2	25	24.7	25

¹MCA = Minimum Circuit Ampacity (Wiring Size Amps) ²MFS = Maximum Fuse or HACR Breaker Size ³SPPE = Single Point Power Entry
MCA & MFS are calculated at 230 volts on the ACA & ACC models. The 460 volts ACD models are calculated at 460 volts. This chart should only be used as a guideline for estimating conductor size and overcurrent protection. For the requirements of specific units, always refer to the data label on the unit.

**Summary Electrical Ratings (Wire and Circuit Breaker Sizing) -
HVEA Air Conditioners with Electric Reheat ("R") with Single stage Compressors and
Ventilation Configurations:
Manual Damper, up to 15% Outside Air ("N")
Economizer, Outside Air with Pressure Relief ("C")**

ELECTRIC HEAT		000 = None		040 = 4 kw		050 = 5 kw		060 = 6 kw		080 = 8 kw		090 = 9 kw		100 = 10 kw		120 = 12 kw		150 = 15 kw	
BASIC MODEL	VOLTAGE PHASE / HZ	SPPE ³		SPPE ³		SPPE ³		SPPE ³		SPPE ³		SPPE ³		SPPE ³		SPPE ³		SPPE ³	
		MCA ¹	MFS ²	MCA ¹	MFS ²	MCA ¹	MFS ²	MCA ¹	MFS ²	MCA ¹	MFS ²	MCA ¹	MFS ²	MCA ¹	MFS ²	MCA ¹	MFS ²	MCA ¹	MFS ²
HVEA24ACA	208/230-1-60	20.6	30	41.5	45	46.6	50	51.9	60					72.7	80				
HVEA30ACA	208/230-1-60	21.6	30	42.5	45	47.6	50	52.9	60					73.7	80	84.1	90	99.7	100
HVEA36ACA	208/230-1-60	26.4	40	47.3	50	52.4	60	57.7	60					78.5	80	88.9	90	104.5	110
HVEA42ACA	208/230-1-60	30.4	50	51.3	60	56.4	60							82.5	90	92.9	100	108.5	110
HVEA49ACA	208/230-1-60	34.4	50			60.4	70							86.5	90	96.9	100	112.5	120
HVEA60ACA	208/230-1-60	40.1	60			66.1	70							92.2	100	102.6	110	118.2	120
HVEA24ACC	208/230-3-60	14.2	20					32.2	35			41.3	45			50.3	60	59.3	60
HVEA30ACC	208/230-3-60	16.0	20					34.0	35			43.1	45			52.1	60	61.1	70
HVEA36ACC	208/230-3-60	18.6	25					36.6	40			45.7	50			54.7	60	63.7	70
HVEA42ACC	208/230-3-60	22.6	35					40.6	45			49.7	50			58.7	60	67.7	70
HVEA49ACC	208/230-3-60	24.2	35					42.2	45			51.3	60			60.3	70	69.3	70
HVEA60ACC	208/230-3-60	27.0	40					45.0	45			54.1	60			63.1	70	72.1	80
HVEA24ACD	460-3-60	7.3	15					16.3	20			20.8	25			25.3	30	29.8	30
HVEA30ACD	460-3-60	9.2	15					18.2	20			22.7	25			27.2	30	31.7	35
HVEA36ACD	460-3-60	10.1	15					19.1	20			23.6	25			28.1	30	32.6	35
HVEA42ACD	460-3-60	10.4	15					19.4	20			23.9	25			28.4	30	32.9	35
HVEA49ACD	460-3-60	11.3	15					20.3	25			24.8	25			29.3	30	33.8	35
HVEA60ACD	460-3-60	13.2	20					22.2	25			26.7	30			31.2	35	35.7	40

¹MCA = Minimum Circuit Ampacity (Wiring Size Amps) ²MFS = Maximum Fuse or HACR Breaker Size ³SPPE = Single Point Power Entry
MCA & MFS are calculated at 230 volts on the ACA & ACC models. The 460 volts ACD models are calculated at 460 volts. This chart should only be used as a guideline for estimating conductor size and overcurrent protection. For the requirements of specific units, always refer to the data label on the unit.

**Unit Load Amps -
HVEA Air Conditioners with with Single stage Compressors and Ventilation Configurations:
Manual Damper, up to 15% Outside Air ("N")
Economizer, Outside Air with Pressure Relief ("C")**

BASIC MODEL NUMBER	VOLTAGE PHASE / HZ	CURRENT AMPS		LOAD OF RESISTIVE HEATING - ELEMENTS ONLY (AMPS) <small>(1) ALL HEATING ELEMENTS ARE ON A SEPARATE CIRCUIT (2) SHADED VALUES (12 & 15 kW) UTILIZE TWO CIRCUITS</small>								TOTAL MAXIMUM HEATING AMPS <small>INCLUDES AMPS FROM MOTOR(S) THAT ARE LOCATED ON AN ELECTRICAL CIRCUIT THAT DOES NOT HAVE HEATERS</small>								
		AC ¹	IBM ²	04 kW	05 kW	06 kW	08 kW	09 kW	10 kW	12 kW	15 kW	04 Kw	05 Kw	06 Kw	08 Kw	09 Kw	10 Kw	12 Kw	15 Kw	
				HVEA24ACA	208/230-1-60	17.4	2.8	16.7	20.8	25.0	33.3		41.7			19.5	23.6	27.8	36.1	
HVEA30ACA	208/230-1-60	18.4	2.8	16.7	20.8	25.0	33.3		41.7	50.0	62.5	19.5	23.6	27.8	36.1		44.5	52.8	65.3	
HVEA36ACA	208/230-1-60	22.2	2.8	16.7	20.8	25.0	33.3		41.7	50.0	62.5	19.5	23.6	27.8	36.1		44.5	52.8	65.3	
HVEA42ACA	208/230-1-60	25.4	2.8	16.7	20.8				41.7	50.0	62.5	19.5	23.6				44.5	52.8	65.3	
HVEA49ACA	208/230-1-60	28.9	4.3		20.8				41.7	50.0	62.5		25.1				46.0	54.3	66.8	
HVEA60ACA	208/230-1-60	33.5	4.3		20.8				41.7	50.0	62.5		25.1				46.0	54.3	66.8	
HVEA24ACC	208/230-3-60	12.3	2.8			14.4		21.7		28.9	36.1				17.2		24.5		31.7	38.9
HVEA30ACC	208/230-3-60	13.9	2.8			14.4		21.7		28.9	36.1				17.2		24.5		31.7	38.9
HVEA36ACC	208/230-3-60	16.0	2.8			14.4		21.7		28.9	36.1				17.2		24.5		31.7	38.9
HVEA42ACC	208/230-3-60	19.2	2.8			14.4		21.7		28.9	36.1				17.2		24.5		31.7	38.9
HVEA49ACC	208/230-3-60	20.8	4.3			14.4		21.7		28.9	36.1			18.7		26.0		33.2	40.4	
HVEA60ACC	208/230-3-60	23.0	4.3			14.4		21.7		28.9	36.1			18.7		26.0		33.2	40.4	
HVEA24ACD	460-3-60	6.3	1.4			7.2		10.8		14.4	18.0			8.6		12.2		15.8	19.4	
HVEA30ACD	460-3-60	7.9	1.4			7.2		10.8		14.4	18.0			8.6		12.2		15.8	19.4	
HVEA36ACD	460-3-60	8.6	1.4			7.2		10.8		14.4	18.0			8.6		12.2		15.8	19.4	
HVEA42ACD	460-3-60	8.9	1.4			7.2		10.8		14.4	18.0			8.6		12.2		15.8	19.4	
HVEA49ACD	460-3-60	9.8	2.2			7.2		10.8		14.4	18.0			9.4		13.0		16.6	20.2	
HVEA60ACD	460-3-60	11.3	2.2			7.2		10.8		14.4	18.0			9.4		13.0		16.6	20.2	

¹AC = Air Conditioner Unit Amps ²IBM = Indoor Blower Motor
Heating kW is rated at 240 volts on the ACA & ACC models. Derate heater output by 25% for operation at 208 volts. Heating kW is rated at 480 volts on the ACD models.
Total heating and cooling amps includes all motors. Three phase models contain single phase motor loads. Loads are not equally balanced on each phase and values shown are maximum phase loads.

ComPac® HVESA & AVHSA Air Conditioners with 2-Stage Compressor

Certified Efficiency and Capacity Ratings at ANSI/AHRI Standard 390 for HVESA & AVHSA Air Conditioners with 2-Stage Compressors



Model Number	HVESA36			HVESA42			HVESA49			HVESA60			AVHSA72		
	ACA	ACC	ACD	ACA	ACC	ACD	ACA	ACC	ACD	ACA	ACC	ACD	ACA	ACC	ACD
Cooling BTUH ¹ - 2nd Stage	35,000			39,000			47,000			56,000			67,300		
EER ² - 2nd Stage	11.00			10.50			11.75			11.00			11.00		
Integrated Part Load Value ³	16.00			14.10			16.00			14.80			14.00		
Rated Air Flow (CFM ⁴)	1,300			1,400			1,750			1,900			2,150		

¹Cooling rated at 95°F (35°C) outdoor and 80°F DB/67° WB (26.5°C DB/19.5°C WB) return air. ²EER=Energy Efficiency Ratio
³Integrated Part Load Value is an integrated efficiency measure from 1st and 2nd stage capacity modulation. ⁴CFM=Cubic Feet per Minute
Ratings are with no outside air. Performance will be affected by altitude.
Ratings are at 230 volts for 208/230 volt units ("A" & "C" models) and 460 volts for "D" models. Operation of units at a different voltage from that of the rating point will affect performance and air flow.

Sensible Total Heat Ratio @ 95°F (35°C) Outside Air Dry Bulb - HVESA & AVHSA Air Conditioners with 2-Stage Compressors

Model Number	HVESA36			HVESA42			HVESA49			HVESA60			AVHSA72		
	ACA	ACC	ACD	ACA	ACC	ACD	ACA	ACC	ACD	ACA	ACC	ACD	ACA	ACC	ACD
Total Capacity	35,000			39,000			47,000			56,000			67,300		
Sensible Heat Ratio	0.70			0.71			0.79			0.77			0.68		
Sensible Capacity	24,445			27,590			36,920			43,235			45,765		
Rated Air Flow (CFM ¹)	1,300			1,400			1,750			1,900			2,150		

¹CFM=Cubic Feet per Minute
Sensible heat ratios based upon ANSI/AHRI std. 390 outdoor air conditions of 95°F (35°C) and 80°F DB/67° WB (26.5°C DB/19.5°C WB) return air.

Stage 2 Cooling Performance (BTUH) at Various Outdoor Temperatures

Model Number	Outdoor Temperature				
	75°F / 24°C	80°F / 26.5°C	85°F / 29°C	90°F / 32°C	95°F / 35°C
HVESA36AC	40,600	39,200	37,800	36,400	35,000
HVESA42AC	45,240	43,680	42,120	40,560	39,000
HVESA49AC	54,520	52,640	50,760	48,880	47,000
HVESA60AC	64,960	62,720	60,480	58,240	56,000
AVHSA72AC	78,068	75,376	72,684	69,992	67,300

Based upon ANSI/AHRI std. 390 return air conditions of 80°F DB/67° WB (26.5°C DB/19.5°C WB) at various outdoor temperatures.

Stage 1 Cooling Performance (BTUH) at Various Outdoor Temperatures

Model Number	Outdoor Temperature				
	75°F / 24°C	80°F / 26.5°C	85°F / 29°C	90°F / 32°C	95°F / 35°C
HVESA36AC	30,856	29,792	28,728	27,664	26,600
HVESA42AC	34,336	33,152	31,968	30,784	29,600
HVESA49AC	44,080	42,560	41,040	39,520	38,000
HVESA60AC	51,040	49,280	47,520	45,760	44,000
AVHSA72AC	60,436	58,352	56,268	54,184	52,100

Based upon ANSI/AHRI std. 390 return air conditions of 80°F DB/67° WB (26.5°C DB/19.5°C WB) at various outdoor temperatures.

Electrical Characteristics - Compressor, Fan & Blower Motors - HVESA & AVHSA Air Conditioners with 2-Stage Compressor

BASIC MODEL	Type	COMPRESSOR			OUTDOOR FAN MOTOR				INDOOR FAN MOTOR (ECM ⁶)			
		VOLTS-HZ-PH	RLA ¹	LRA ²	VOLTS-HZ-PH	RPM ³	FLA ⁴	HP ⁵	VOLTS-HZ-PH	RPM ³	FLA ⁴	HP ⁵
HVESA36ACA	SCROLL	208/230-60-1	16.6	82.0	208/230-60-1	825	2.8	1/3	208/230-60-1	1500	2.8	1/2
HVESA42ACA		208/230-60-1	16.6	96.0	208/230-60-1	825	2.8	1/3	208/230-60-1	1500	2.8	1/2
HVESA49ACA		208/230-60-1	21.1	96.0	208/230-60-1	825	2.8	1/2	208/230-60-1	1500	4.3	3/4
HVESA60ACA		208/230-60-1	25.6	118.0	208/230-60-1	825	2.8	1/2	208/230-60-1	1500	4.3	3/4
AVHSA72ACA		208/230-60-1	25.6	118.0	208/230-60-1	825	2.8	1/2	208/230-60-1	1500	4.3	3/4
HVESA36ACC	SCROLL	208/230-60-3	11.1	58.0	208/230-60-1	825	2.8	1/3	208/230-60-1	1500	2.8	1/2
HVESA42ACC		208/230-60-3	13.4	88.0	208/230-60-1	825	2.8	1/3	208/230-60-1	1500	2.8	1/2
HVESA49ACC		208/230-60-3	13.4	88.0	208/230-60-1	825	2.8	1/2	208/230-60-1	1500	4.3	3/4
HVESA60ACC		208/230-60-3	17.6	123.0	208/230-60-1	825	2.8	1/2	208/230-60-1	1500	4.3	3/4
AVHSA72ACC		208/230-60-3	17.6	123.0	208/230-60-1	825	2.8	1/2	208/230-60-1	1500	4.3	3/4
HVESA36ACD	SCROLL	460-60-3	4.5	29.0	208/230-60-1	825	2.8	1/3	208/230-60-1	1500	2.8	1/2
HVESA42ACD		460-60-3	6.1	44.0	208/230-60-1	825	2.8	1/3	208/230-60-1	1500	2.8	1/2
HVESA49ACD		460-60-3	6.4	41.0	208/230-60-1	825	2.8	1/2	208/230-60-1	1500	4.3	3/4
HVESA60ACD		460-60-3	9.0	62.0	208/230-60-1	825	2.8	1/2	208/230-60-1	1500	4.3	3/4
AVHSA72ACD		460-60-3	9.0	62.0	208/230-60-1	825	2.8	1/2	208/230-60-1	1500	4.3	3/4

¹RLA = Rated Load Amps ²LRA = Locked Rotor Amps ³RPM = Revolutions per Minute ⁴FLA = Full Load Amps ⁵HP = Horsepower ⁶ECM = Electronically Commutated Motor
The 460 volt units have a step down transformer for the 230 volt motors.

Summary Electrical Ratings (Wire and Circuit Breaker Sizing) - HVESA & AVHSA Air Conditioners with 2-Stage Compressor and Ventilation Configurations: Manual Damper, up to 15% Outside Air ("N") Economizer, Outside Air with Pressure Relief ("C")

ELECTRIC HEAT		000 = None		040 = 4 kw		050 = 5 kw		060 = 6 kw		080 = 8 kw		090 = 9 kw		100 = 10 kw		120 = 12 kw		150 = 15 kw	
BASIC MODEL	VOLTAGE PHASE / HZ	SPPE ³		SPPE ³		SPPE ³		SPPE ³		SPPE ³		SPPE ³		SPPE ³		SPPE ³		SPPE ³	
		MCA ¹	MFS ²	MCA ¹	MFS ²	MCA ¹	MFS ²	MCA ¹	MFS ²	MCA ¹	MFS ²	MCA ¹	MFS ²	MCA ¹	MFS ²	MCA ¹	MFS ²	MCA ¹	MFS ²
HVESA36ACA	208/230-1-60	24.6	35	24.6	35	28.8	35	34.1	35	44.4	45			54.9	60	65.3	70	80.9	90
HVESA42ACA	208/230-1-60	28.0	45	28.0	45	28.8	45							54.9	60	65.3	70	80.9	90
HVESA49ACA	208/230-1-60	33.5	50			33.5	50							56.4	60	66.8	70	82.4	90
HVESA60ACA	208/230-1-60	41.0	60			41.0	60							56.4	60	66.8	70	82.4	90
AVHSA72ACA	208/230-1-60	41.0	80			41.0	80							56.4	80	66.8	70	82.4	90
HVESA36ACC	208/230-3-60	20.1	30					20.8	25			29.9	30			38.9	40	47.9	50
HVESA42ACC	208/230-3-60	23.2	35					23.2	35			29.9	35			38.9	40	47.9	50
HVESA49ACC	208/230-3-60	24.6	35					24.6	35			31.4	35			40.4	50	49.4	50
HVESA60ACC	208/230-3-60	27.7	40					27.7	40			31.4	40			40.4	50	49.4	50
AVHSA72ACC	208/230-3-60	27.7	40					27.7	40			31.4	40			40.4	50	49.4	50
HVESA36ACD	460-3-60	9.9	15					10.4	15			14.9	15			19.4	20	23.9	25
HVESA42ACD	460-3-60	10.6	15					10.6	15			14.9	15			19.4	20	23.9	25
HVESA49ACD	460-3-60	11.6	15					11.6	15			15.7	20			20.2	25	24.7	25
HVESA60ACD	460-3-60	14.7	20					14.7	20			15.7	20			20.2	25	24.7	25
AVHSA72ACD	460-3-60	14.7	20					14.7	20			15.7	20			20.2	25	24.7	25

¹MCA = Minimum Circuit Ampacity (Wiring Size Amps) ²MFS = Maximum Fuse or HACR Breaker Size ³SPPE = Single Point Power Entry
MCA & MFS are calculated at 230 volts on the ACA & ACC models. The 460 volts ACD models are calculated at 460 volts. This chart should only be used as a guideline for estimating conductor size and overcurrent protection. For the requirements of specific units, always refer to the data label on the unit.

Summary Electrical Ratings (Wire and Circuit Breaker Sizing) - HVESA & AVHSA Air Conditioners with Two Stage Compressor, Electric Reheat ("R") and Ventilation Configurations: Manual Damper, up to 15% Outside Air ("N") Economizer, Outside Air with Pressure Relief ("C")

ELECTRIC HEAT		000 = None		040 = 4 kw		050 = 5 kw		060 = 6 kw		080 = 8 kw		090 = 9 kw		100 = 10 kw		120 = 12 kw		150 = 15 kw	
BASIC MODEL	VOLTAGE PHASE / HZ	SPPE ³		SPPE ³		SPPE ³		SPPE ³		SPPE ³		SPPE ³		SPPE ³		SPPE ³		SPPE ³	
		MCA ¹	MFS ²	MCA ¹	MFS ²	MCA ¹	MFS ²	MCA ¹	MFS ²	MCA ¹	MFS ²	MCA ¹	MFS ²	MCA ¹	MFS ²	MCA ¹	MFS ²	MCA ¹	MFS ²
HVESA36ACA	208/230-1-60	24.6	35	45.5	50	50.6	60	55.9	60					76.7	80	87.1	90	102.7	110
HVESA42ACA	208/230-1-60	28.0	45	48.9	50	54.0	60							80.1	90	90.5	100	106.1	110
HVESA49ACA	208/230-1-60	33.5	50			59.5	60							85.6	90	96.0	100	111.6	120
HVESA60ACA	208/230-1-60	41.0	60			67.0	70							93.1	100	103.5	110	119.1	120
AVHSA72ACA	208/230-1-60	41.0	60			67.0	70							93.1	100	103.5	110	119.1	120
HVESA36ACC	208/230-3-60	20.1	30					38.1	40			47.2	50			56.2	60	65.2	70
HVESA42ACC	208/230-3-60	23.2	35					41.2	45			50.3	60			59.3	60	68.3	70
HVESA49ACC	208/230-3-60	24.6	35					42.6	45			51.7	60			60.7	70	69.7	70
HVESA60ACC	208/230-3-60	27.7	40					45.7	50			54.8	60			63.8	70	72.8	80
AVHSA72ACC	208/230-3-60	27.7	40					45.7	50			54.8	60			63.8	70	72.8	80
HVESA36ACD	460-3-60	9.9	15					18.9	20			23.4	25			27.9	30	32.4	35
HVESA42ACD	460-3-60	10.6	15					19.6	20			24.1	25			28.6	30	33.1	35
HVESA49ACD	460-3-60	11.6	15					20.6	25			25.1	30			29.6	30	34.1	35
HVESA60ACD	460-3-60	12.6	15					21.6	25			26.1	30			30.6	35	35.1	40
AVHSA72ACD	460-3-60	12.6	15					21.6	25			26.1	30			30.6	35	35.1	40

¹MCA = Minimum Circuit Ampacity (Wiring Size Amps) ²MFS = Maximum Fuse or HACR Breaker Size ³SPPE = Single Point Power Entry
MCA & MFS are calculated at 230 volts on the ACA & ACC models. The 460 volts ACD models are calculated at 460 volts. This chart should only be used as a guideline for estimating conductor size and overcurrent protection. For the requirements of specific units, always refer to the data label on the unit.

Unit Load Amps - HVESA & AVHSA Air Conditioners with 2-Stage Compressor and Ventilation Configurations: Manual Damper, up to 15% Outside Air ("N") Economizer, Outside Air with Pressure Relief ("C")

BASIC MODEL NUMBER	VOLTAGE PHASE / HZ	CURRENT AMPS		LOAD OF RESISTIVE HEATING - ELEMENTS ONLY (AMPS)										TOTAL MAXIMUM HEATING AMPS						
				(1) ALL HEATING ELEMENTS ARE ON A SEPARATE CIRCUIT (2) SHADED VALUES (12 & 15 KW) UTILIZE TWO CIRCUITS										INCLUDES AMPS FROM MOTOR(S) THAT ARE LOCATED ON AN ELECTRICAL CIRCUIT THAT DOES NOT HAVE HEATERS						
		AC ¹	IBM ²	04 kW	05 kW	06 kW	08 kW	09 kW	10 kW	12 kW	15 kW	04 Kw	05 Kw	06 Kw	08 Kw	09 Kw	10 Kw	12 Kw	15 Kw	
HVESA36ACA	208/230-1-60	20.8	2.8	16.7	20.8	25.0	33.3			41.7	50.0	62.5	19.5	23.6	27.8	36.1		44.5	52.8	65.3
HVESA42ACA	208/230-1-60	23.5	2.8	16.7	20.8					41.7	50.0	62.5	19.5	23.6				44.5	52.8	65.3
HVESA49ACA	208/230-1-60	28.2	4.3		20.8					41.7	50.0	62.5		25.1				46.0	54.3	66.8
HVESA60ACA	208/230-1-60	34.2	4.3		20.8					41.7	50.0	62.5		25.1				46.0	54.3	66.8
AVHSA72ACA	208/230-1-60	34.2	4.3		20.8					41.7	50.0	62.5		25.1				46.0	54.3	66.8
HVESA36ACC	208/230-3-60	17.2	2.8			14.4		21.7			28.9	36.1			17.2		24.5		31.7	38.9
HVESA42ACC	208/230-3-60	19.7	2.8			14.4		21.7			28.9	36.1			17.2		24.5		31.7	38.9
HVESA49ACC	208/230-3-60	21.1	4.3			14.4		21.7			28.9	36.1			18.7		26.0		33.2	40.4
HVESA60ACC	208/230-3-60	23.6	4.3			14.4		21.7			28.9	36.1			18.7		26.0		33.2	40.4
AVHSA72ACC	208/230-3-60	23.6	4.3			14.4		21.7			28.9	36.1			18.7		26.0		33.2	40.4
HVESA36ACD	460-3-60	8.5	1.4			7.2		10.8			14.4	18.0			8.6		12.2		15.8	19.4
HVESA42ACD	460-3-60	9.0	1.4			7.2		10.8			14.4	18.0			8.6		12.2		15.8	19.4
HVESA49ACD	460-3-60	9.2	2.2			7.2		10.8			14.4	18.0			9.4		13.0		16.6	20.2
HVESA60ACD	460-3-60	10.0	2.2			7.2		10.8			14.4	18.0			9.4		13.0		16.6	20.2
AVHSA72ACD	460-3-60	10.0	2.2			7.2		10.8			14.4	18.0			9.4		13.0		16.6	20.2

¹AC = Air Conditioner Unit Amps ²IBM = Indoor Blower Motor
Heating kW is rated at 240 volts on the ACA & ACC models. Derate heater output by 25% for operation at 208 volts. Heating kW is rated at 480 volts on the ACD models.
Total heating and cooling amps includes all motors. Three phase models contain single phase motor loads. Loads are not equally balanced on each phase and values shown are maximum phase loads.

ComPac Model & Cabinet Designation

MODEL	CABINET DESIGNATION											
	A	B	C	D	E	F	G	H	I	J	K	L
AVPA12 ComPac I	✓											
AVPA12 ComPac II		✓										
AVHA12 ComPac I			✓									
AVHA12 ComPac II				✓								
AVPA20/24 ComPac I & II					✓							
AVHA20/24 ComPac I & II					✓							
AVPA30/36 ComPac I & II						✓						
AVHA30/36 ComPac I & II						✓						
HVEA24 ComPac I & II						✓						
AVPA42/48/60 ComPac I & II							✓					
AVHA42/48/60 ComPac I & II							✓					
HVEA30/36/42 ComPac I & II							✓					
HVESA30/36/42 ComPac I & II							✓					
AVPA72 ComPac I & II								✓				
HVEA49/60 ComPac I & II								✓				
HVESA49/60 ComPac I & II								✓				
HVESA60 ComPac II - Reverse Flow									✓			
AVHSA72 ComPac II										✓		
AVPA42/48/60 with K/04315 Back Panel, ComPac I Only											✓	
AVHA42/48/60 with K/04315 Back Panel, ComPac I Only											✓	
AVPA42/48/60 with K/04317 Back Panel, ComPac I Only												✓
AVHA42/48/60 with K/04317 Back Panel, ComPac I Only												✓

Dimensional Data - Cabinet A

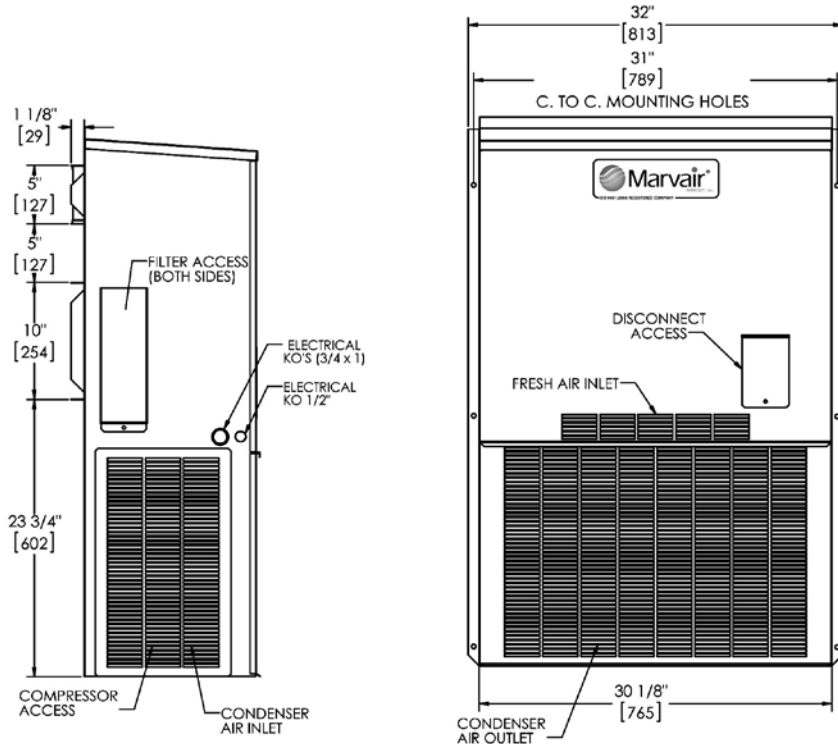

LH SIDE VIEW

FRONT VIEW

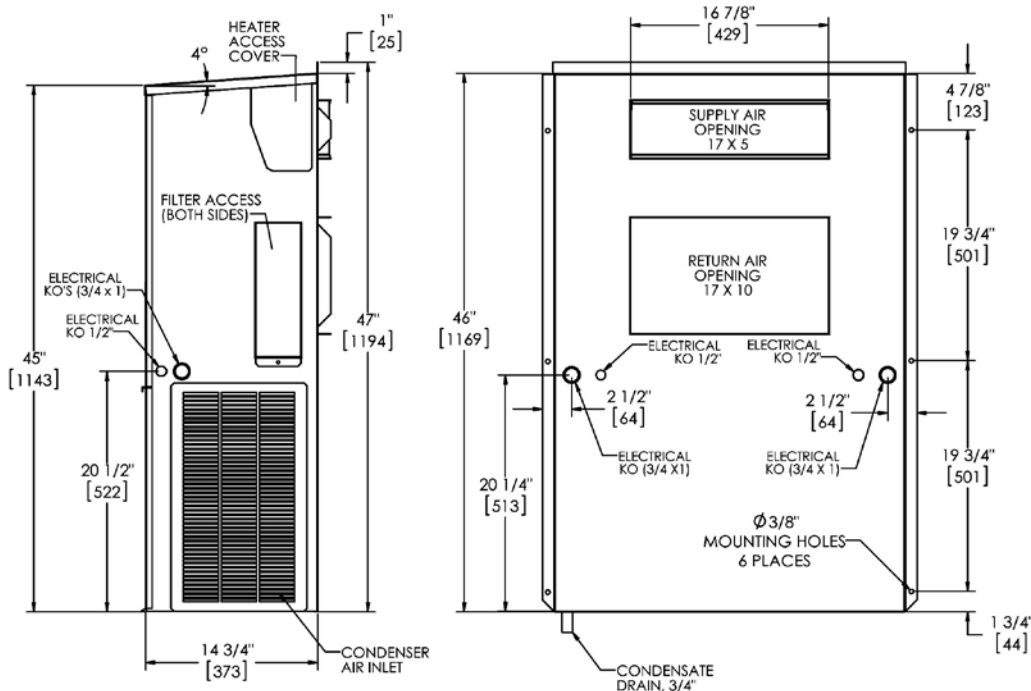

RH SIDE VIEW

REAR VIEW

Shipping Weight (pounds/kilograms)

AVPA12	LBS/KGS
COMPAC I	185/84

Filter Size

AVPA12	INCHES	MILLIMETERS	PART NUMBER	FILTERS PER UNIT	MERV RATING
RETURN AIR FILTER	10" x 20" x 2"	254 x 508 x 52	91974	1	8

Dimensional Data - Cabinet B

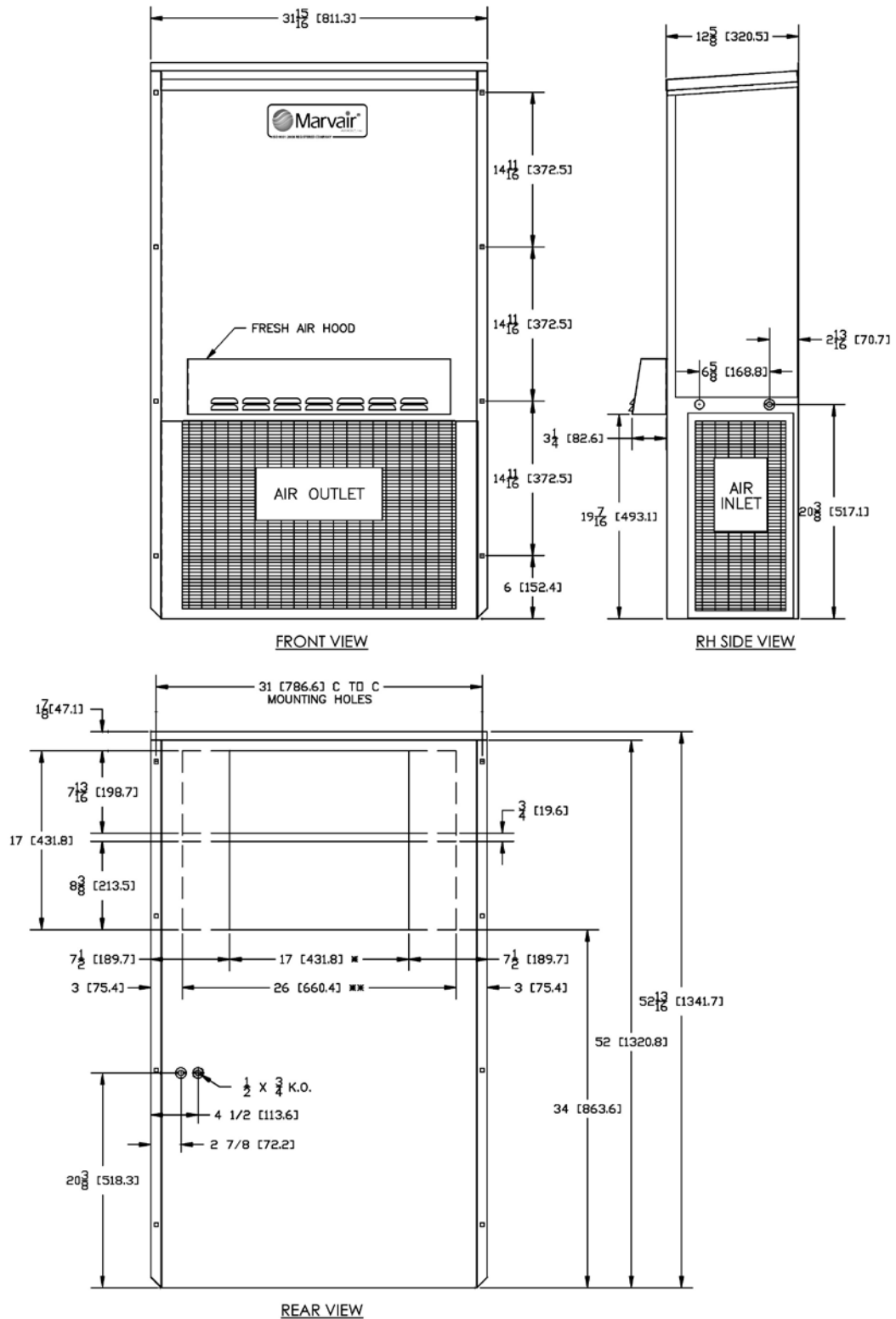

Shipping Weight (pounds/kilograms)

AVPA12	LBS/KGS
COMPAC II	194/88

Filter Size

AVPA12	INCHES	MILLIMETERS	PART NUMBER	FILTERS PER UNIT	MERV RATING
RETURN AIR FILTER	6¼" x 22¼" x 2"	159 x 565 x 52	80172	1	8

Dimensional Data - Cabinet C

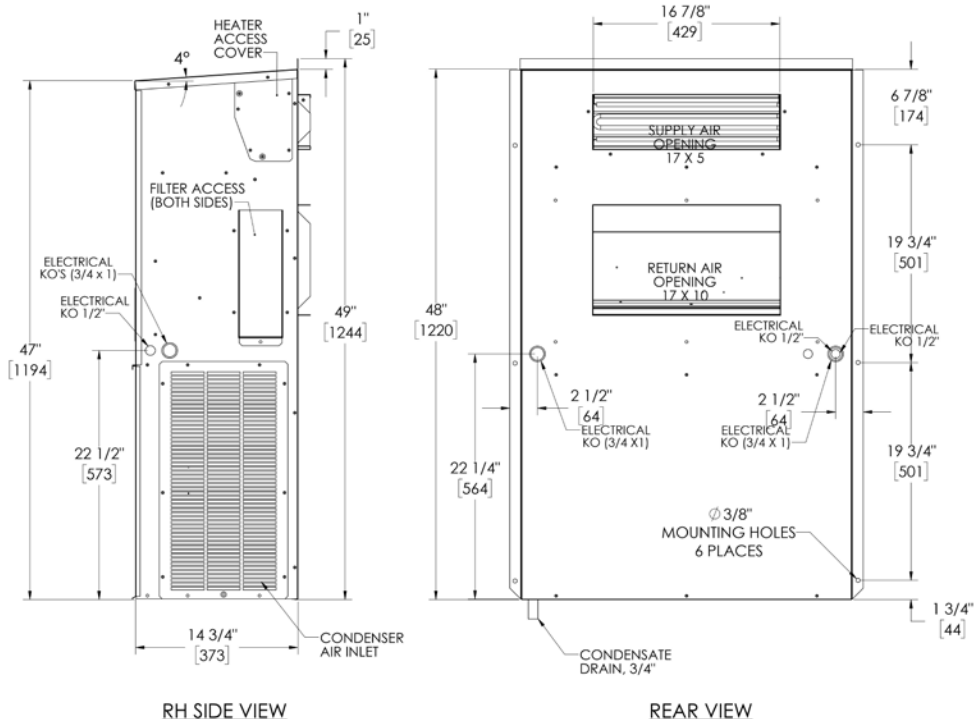
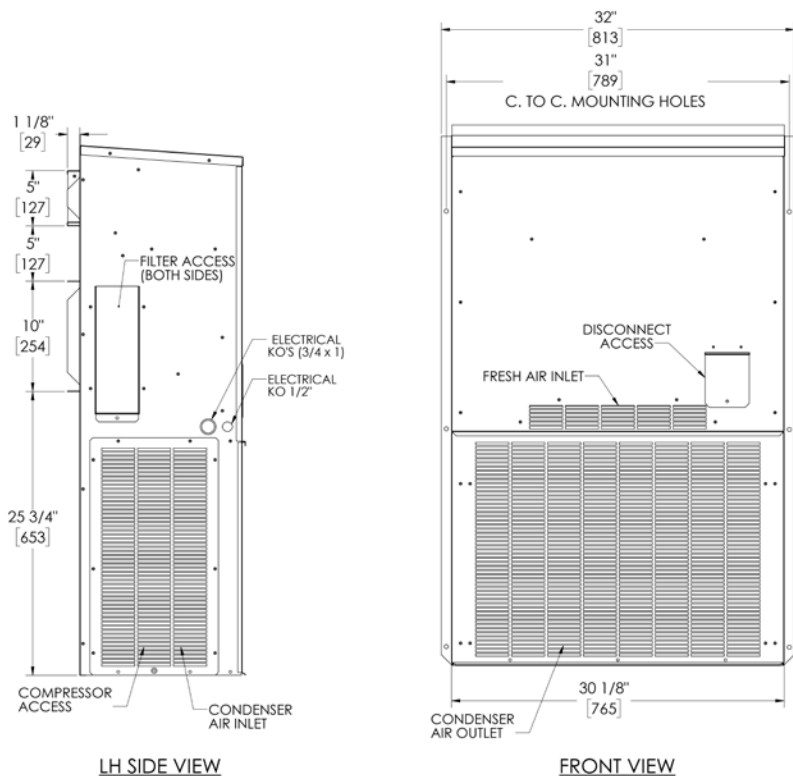

Shipping Weight (pounds/kilograms)

AVHA12	LBS/KGS
COMPAC I	185/84

Filter Size

AVHA12	INCHES	MILLIMETERS	PART NUMBER	FILTERS PER UNIT	MERV RATING
RETURN AIR FILTER	10" x 20" x 2"	254 x 508 x 52	91974	1	8

Dimensional Data - Cabinet D

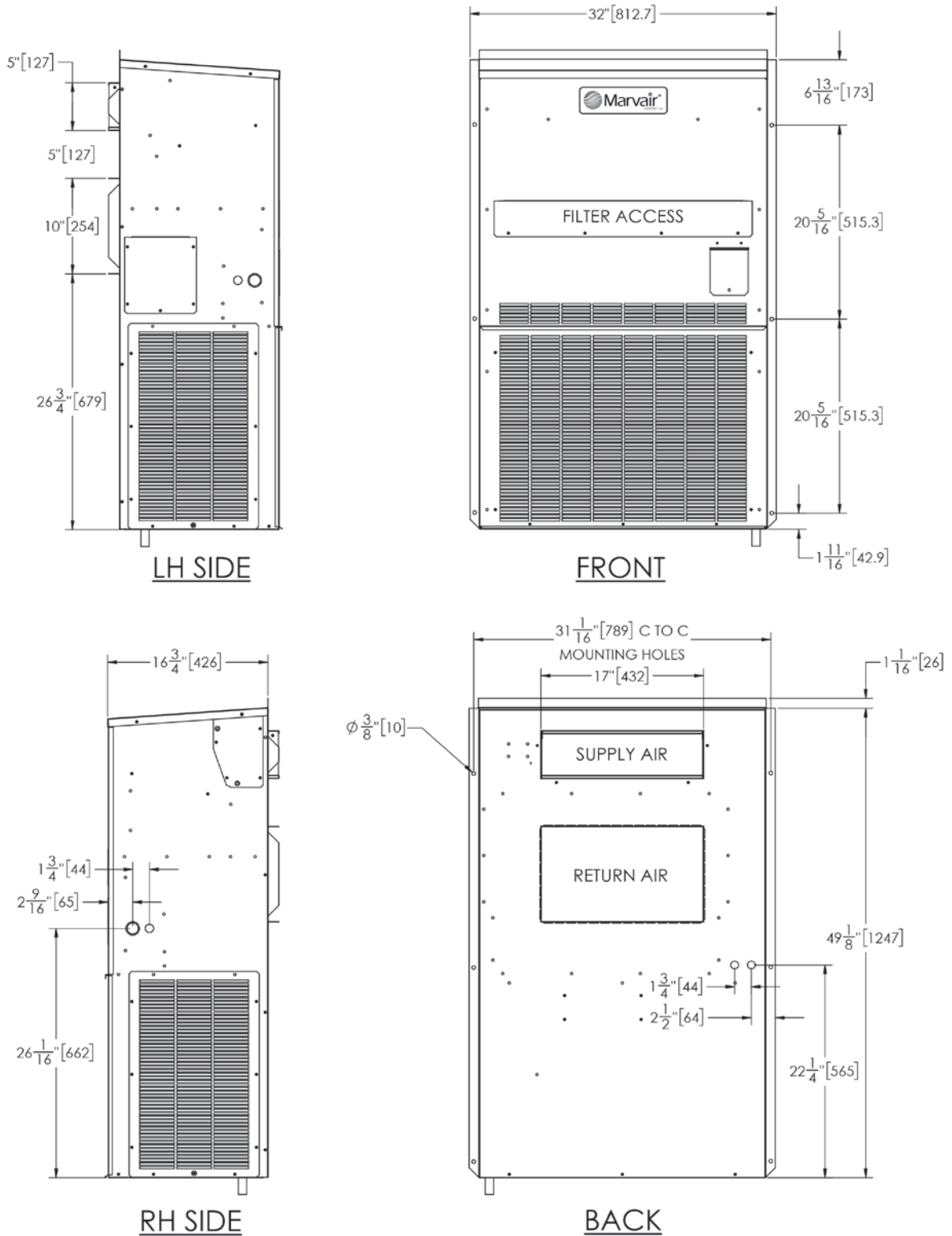

Shipping Weight (pounds/kilograms)

AVHA12	LBS/KGS
COMPAC II	185/84

Filter Size

AVHA12	INCHES	MILLIMETERS	PART NUMBER	FILTERS PER UNIT	MERV RATING
RETURN AIR FILTER	12" x 25" x 1"	305 x 635 x 25	93181	1	8

Dimensional Data - Cabinet E

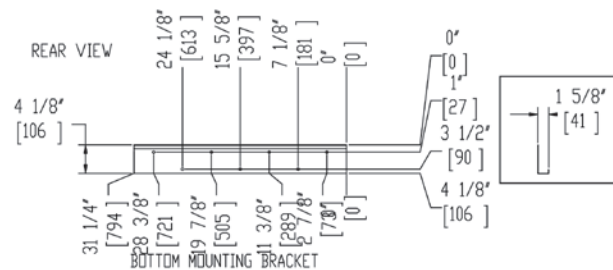
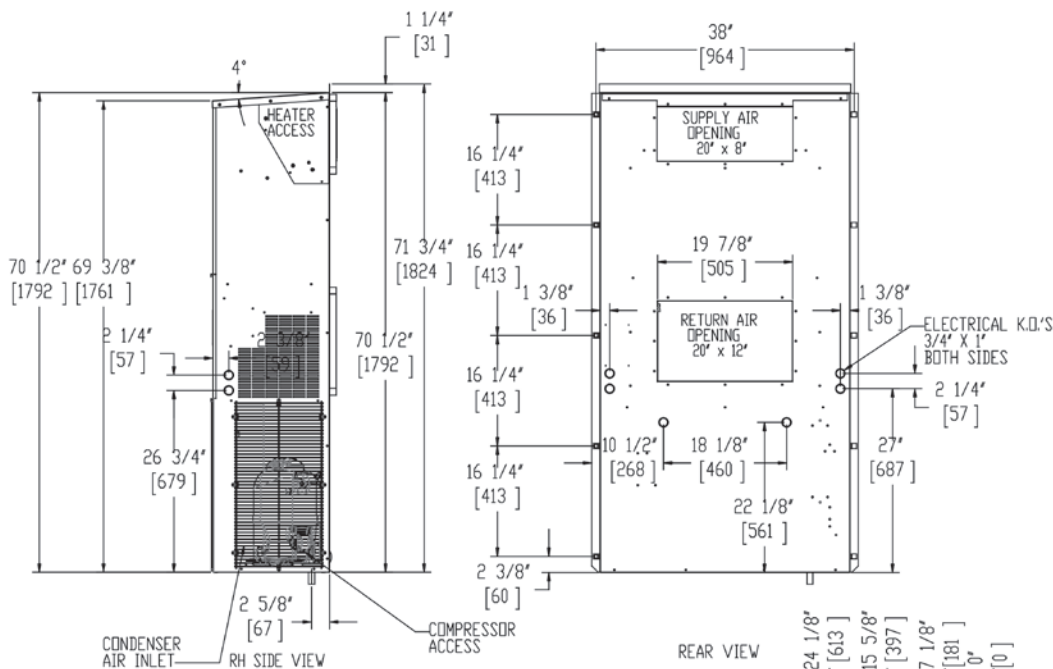
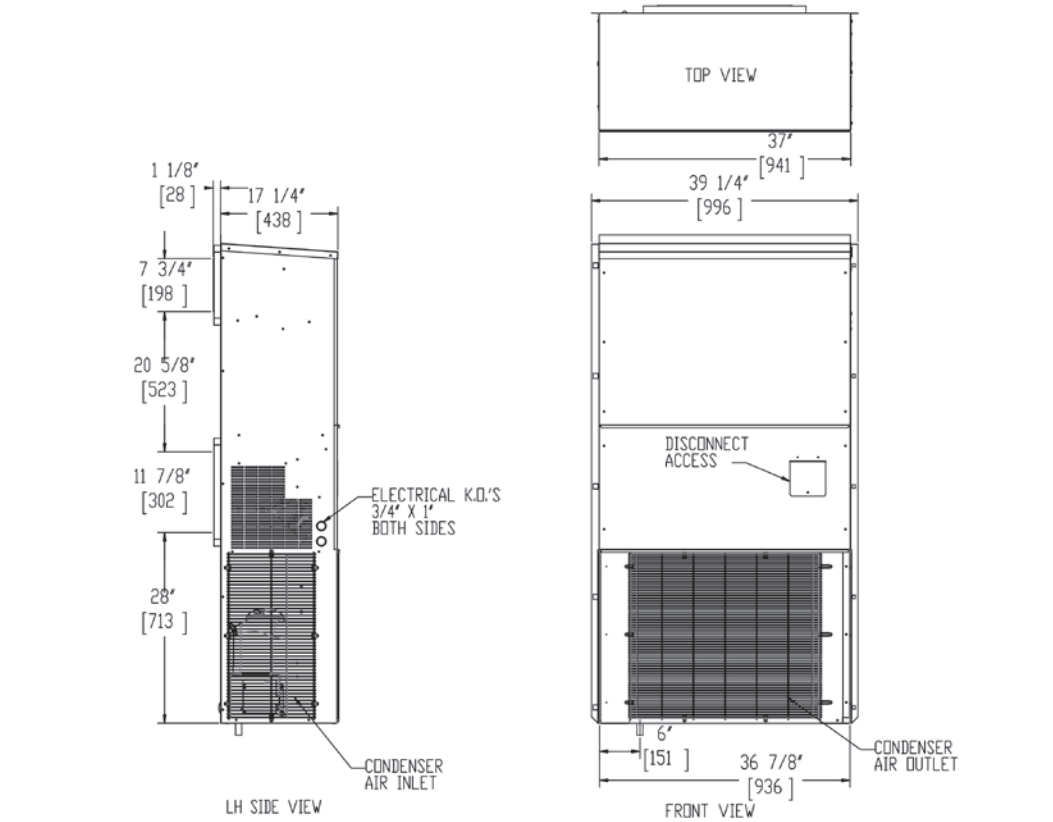

Shipping Weight (pounds/kilograms)

AVPA/AVHA20/24	LBS/KGS
COMPAC I	350/159
COMPAC II	375/170.5

Filter Size

AVPA/AVHA20/24	INCHES	MILLIMETERS	PART NUMBER	FILTERS PER UNIT	MERV RATING
RETURN AIR FILTER	25" x 16" x 2"	635 x 406 x 51	80137	1	7

Dimensional Data -Cabinet F

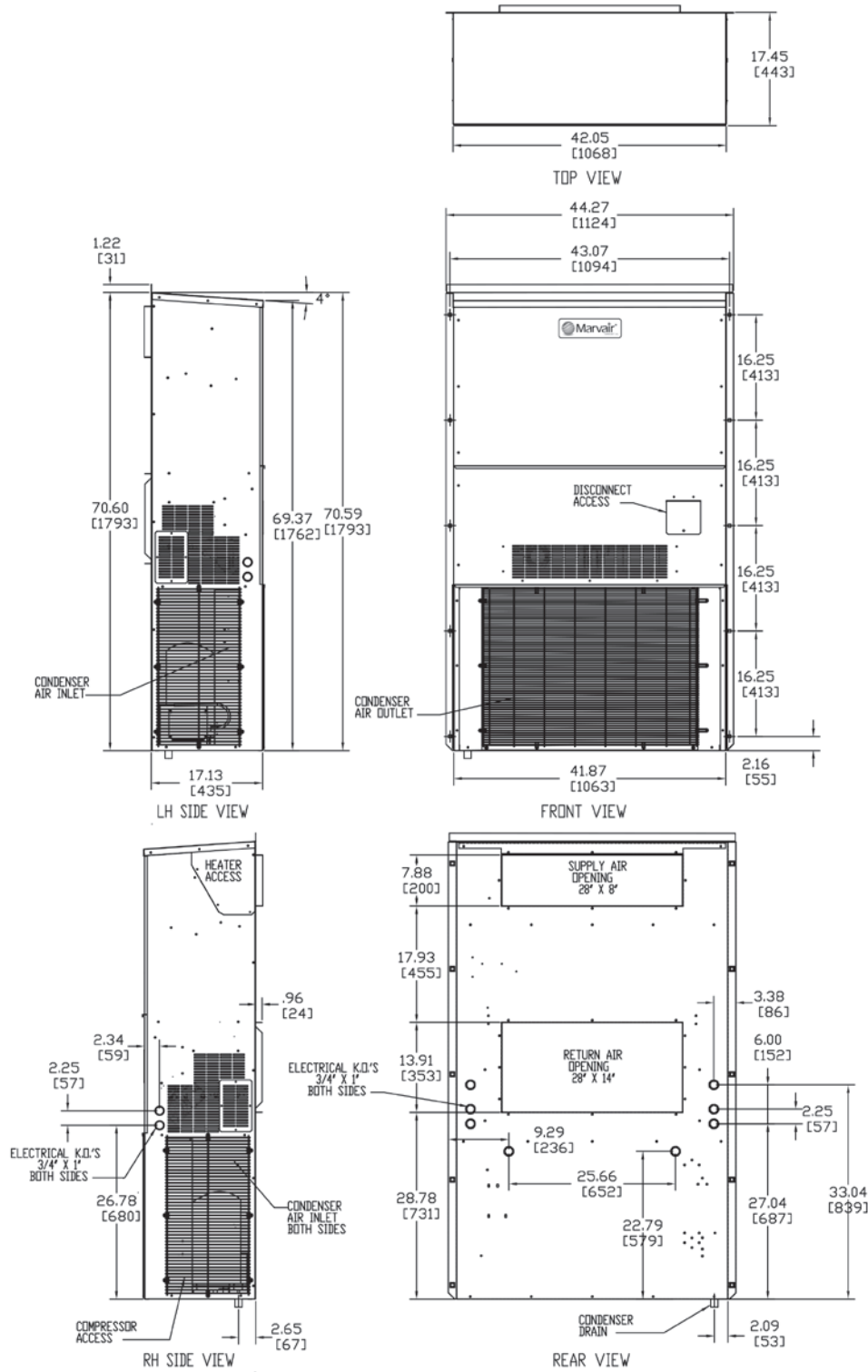

Shipping Weight (pounds/kilograms)

AVPA/AVHA30/36 & HVEA24	LBS/KGS
COMPAC I	420/191
COMPAC II	445/202.5

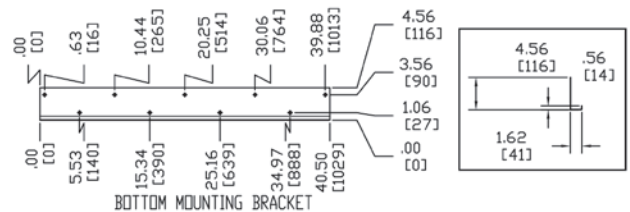

Filter Size

AVPA/AVHA30/36 & HVEA24	INCHES	MILLIMETERS	PART NUMBER	FILTERS PER UNIT	MERV RATING
RETURN AIR FILTER	30 x 16 x 2	762 x 406 x 51	80138	1	8

Dimensional Data - Cabinet G

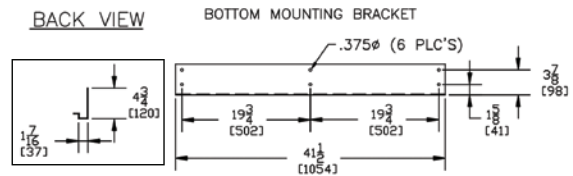
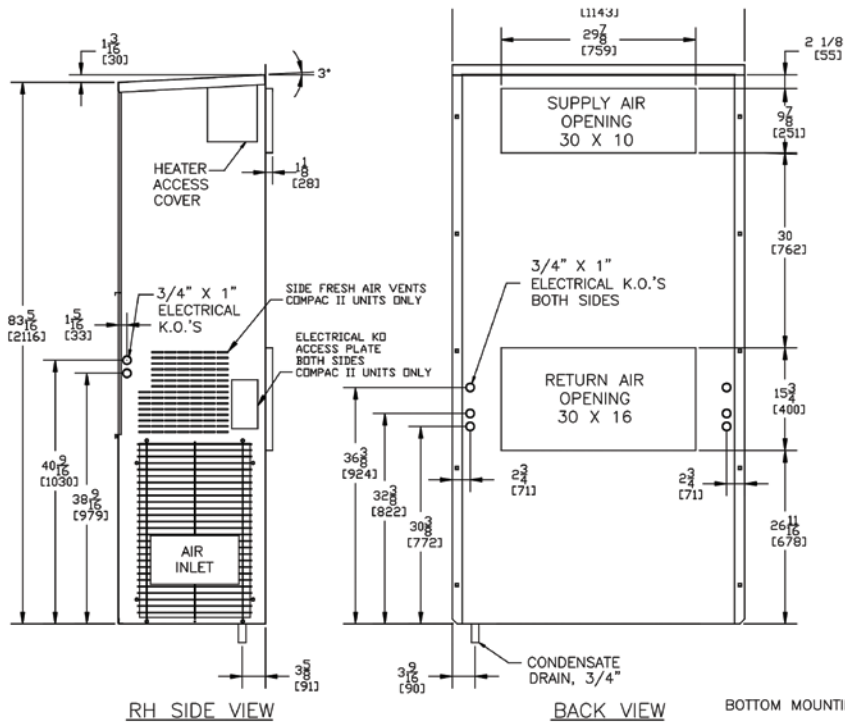
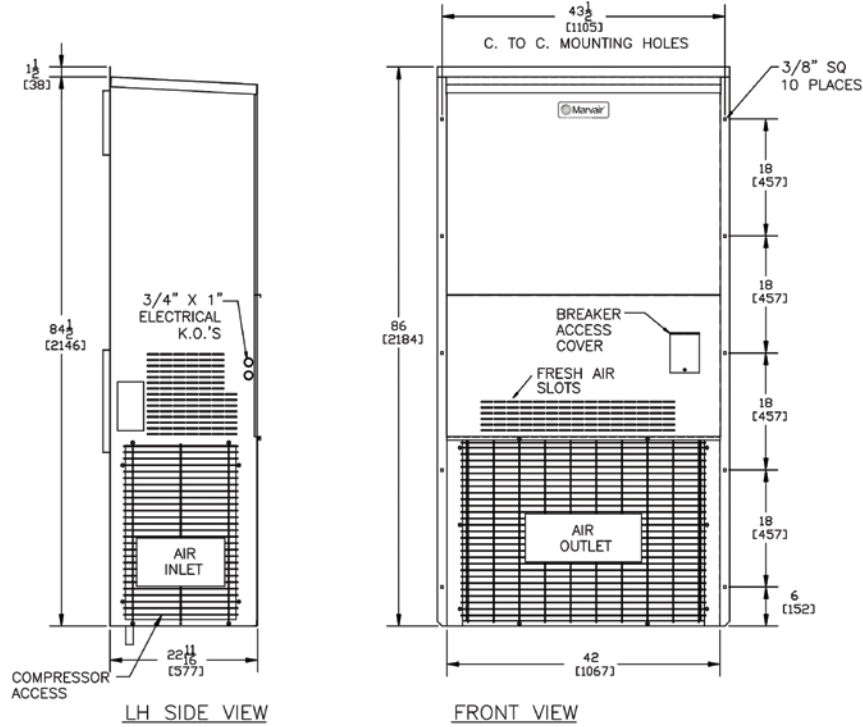

Shipping Weight (pounds/kilograms)

AVPA/AVHA42/48/60 and HVEA30/36/42, HVESA30/36/42	LBS/KGS
COMPAC I	540/245.5
COMPAC II	565/257

Filter Size

AVPA/AVHA42/48/60, HVEA30/36/42, & HVESA30/36/42	INCHES	MILLIMETERS	PART NUMBER	FILTERS PER UNIT	MERV RATING
RETURN AIR FILTER	36 1/2 x 22 x 2	927 x 559 x 51	80162	1	8

Dimensional Data - Cabinet H

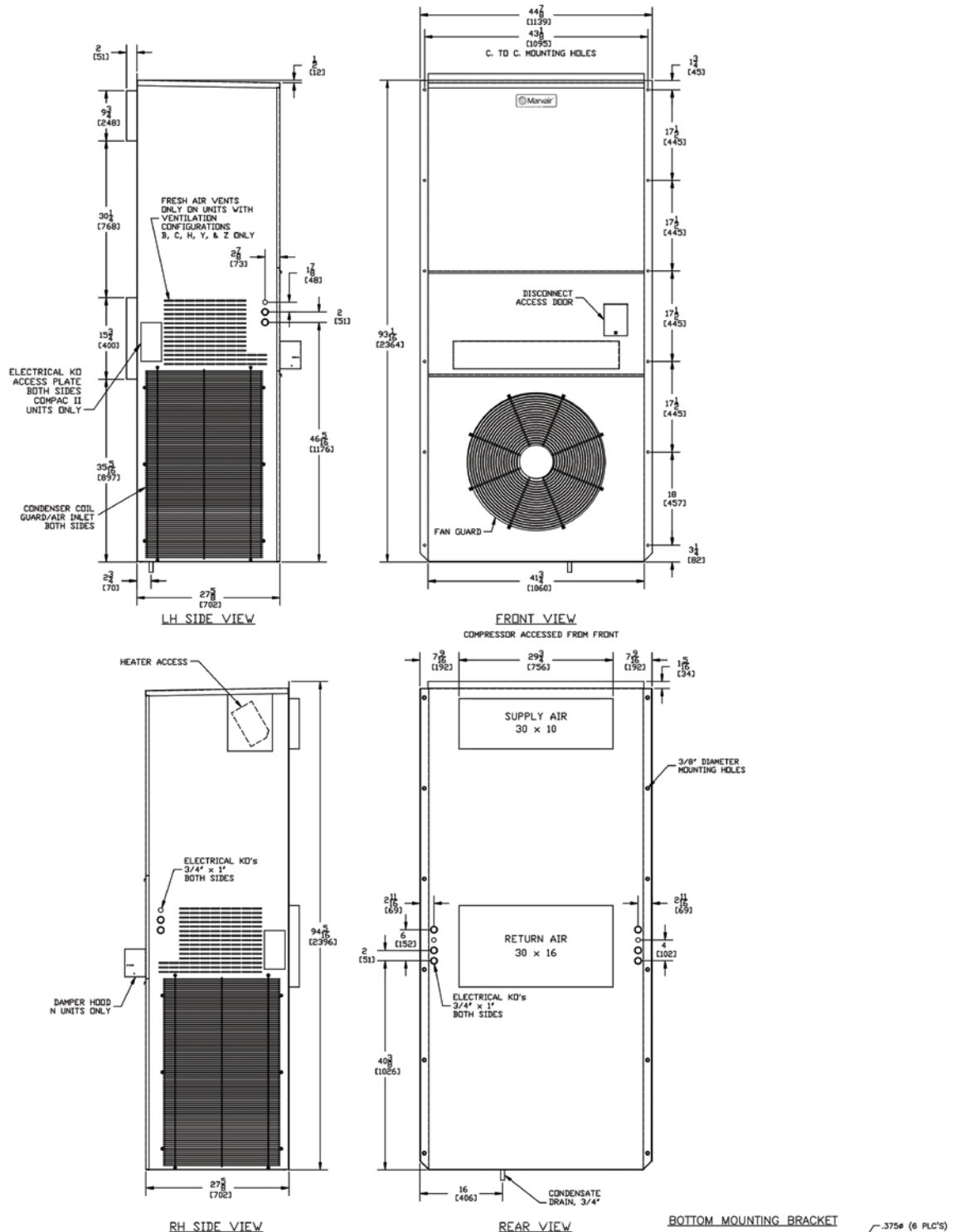

Shipping Weight (pounds/kilograms)

AVPA72, and HVEA49/60, HVESA49/60	LBS/KGS
COMPAC I	680/309
COMPAC II	705/320.5

Filter Size

AVPA72, HVEA49/60 & HVESA49/60	INCHES	MILLIMETERS	PART NUMBER	FILTERS PER UNIT	MERV RATING
RETURN AIR FILTER	18 x 24 x 2	457 x 610 x 51	81257	2	8

Dimensional Data - Cabinet I

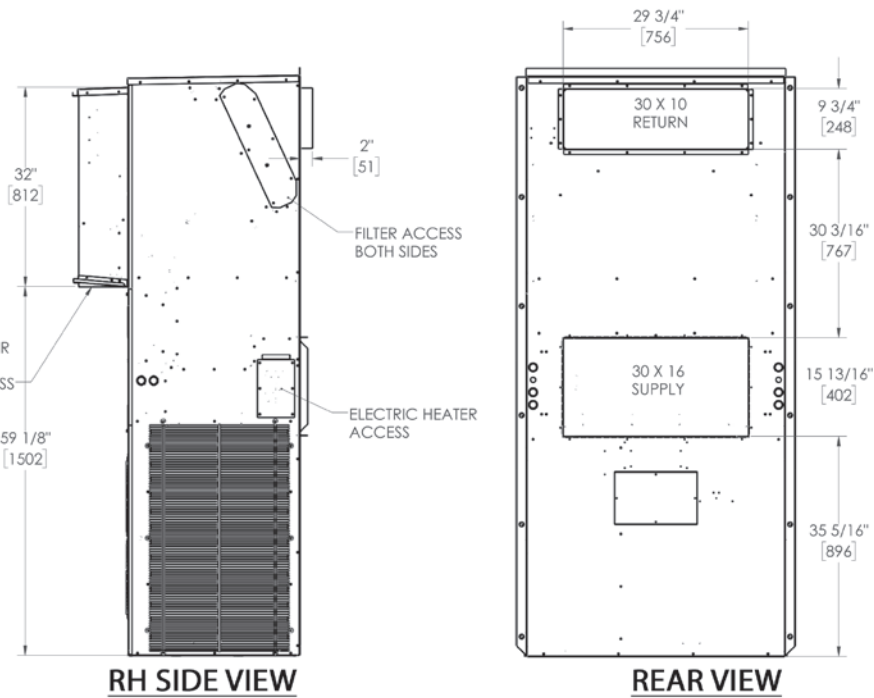
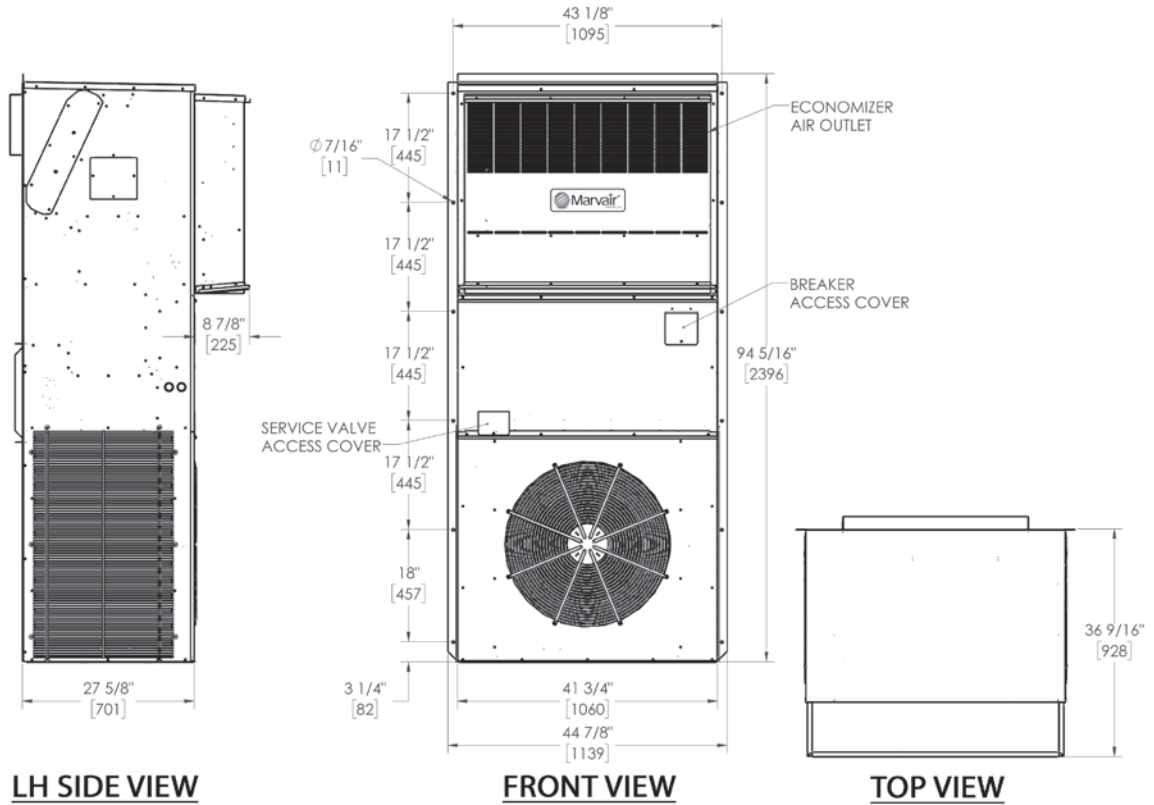

Shipping Weight (lbs/kgs) Filter Size

HVESA60 - REVERSE FLOW	LBS/KGS	HVESA60 - REVERSE FLOW	INCHES	MILLIMETERS	PART NUMBER	FILTERS/UNIT	MERV RATING
COMPAC II	705/320.5	RETURN AIR FILTER	18 x 20 x 1	457 x 508 x 25	91943	2	8
		FRESH AIR HOOD	8 x 38 x 3/8	203 x 965 x 10	93098	1	N/A

Dimensional Data - Cabinet J

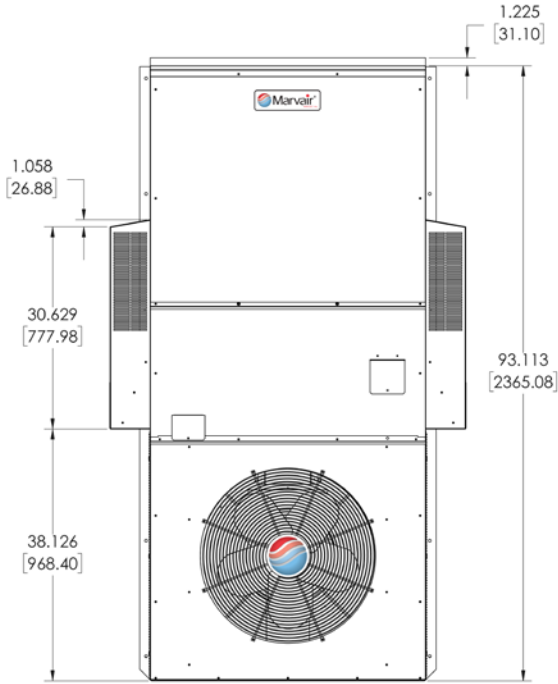

FRONT VIEW

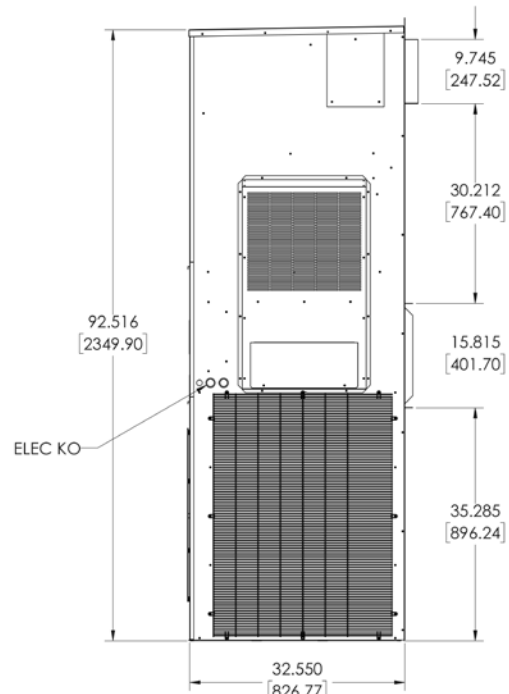

RIGHT VIEW

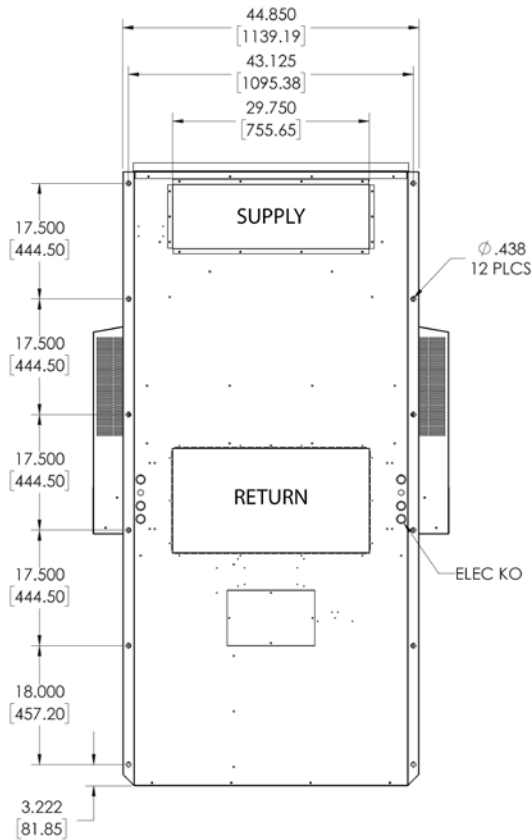

REAR VIEW

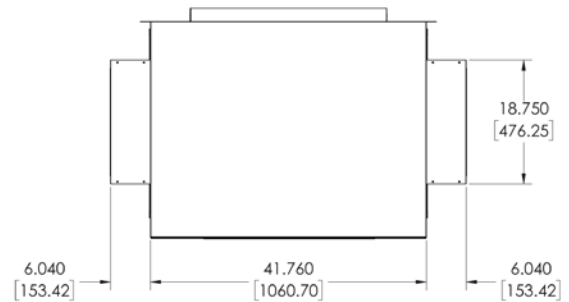

TOP VIEW

Shipping Weight (lbs/kgs)

AVHSA72	LBS/KGS
COMPAC II	740/336

Filter Size

AVHSA72	INCHES	MILLIMETERS	PART NUMBER	FILTERS/UNIT	MERV RATING
RETURN AIR FILTER	18 x 30 x 2	457 x 762 x 52	93184	2	8

Dimensional Data - Cabinet K

For matching existing AVP36 wall opening with new AVPA42/48/60 & AVHA42/48/60
 For Non-Economizer models Only. For Economizer-Equipped models, use transition curb in Options section.

	A	B	C	D	E	F	G	H	I	J	K	L	M	N	O	P	Q
Inches	45	22 $\frac{5}{8}$	86	8	18	14	42 $\frac{1}{2}$	28	1 $\frac{5}{16}$	40 $\frac{9}{16}$	38 $\frac{9}{16}$	1 $\frac{1}{8}$	43 $\frac{1}{8}$	42 $\frac{3}{16}$	40 $\frac{1}{2}$	2 $\frac{1}{4}$	83 $\frac{5}{16}$
mm	1,143	575	2,184	203	457	356	1,080	711	33	1,030	980	29	1,095	1,072	1,029	57	2,116

Note: Dimensional tolerance +/- $\frac{1}{16}$ " (2mm)

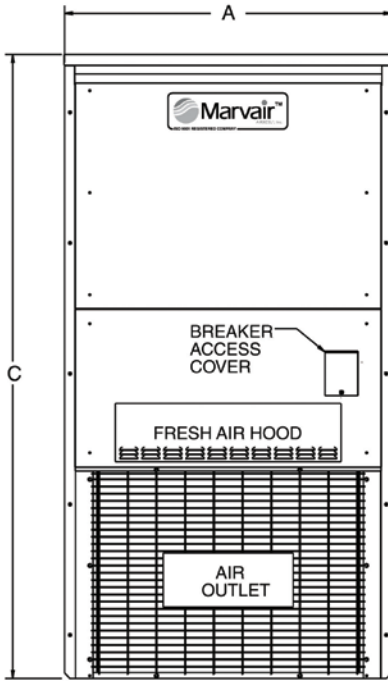

FRONT VIEW

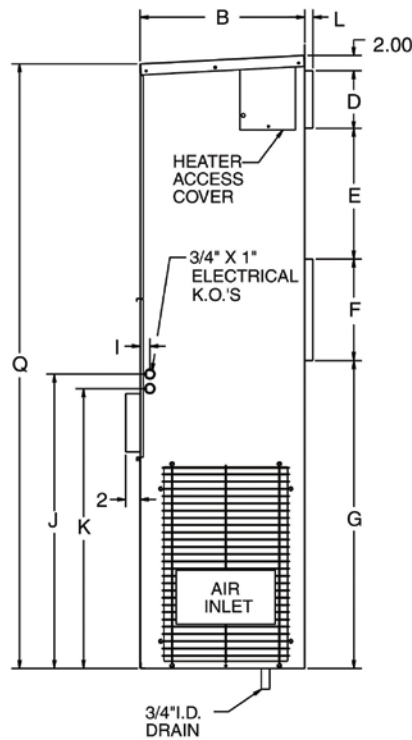

R.H. SIDE VIEW

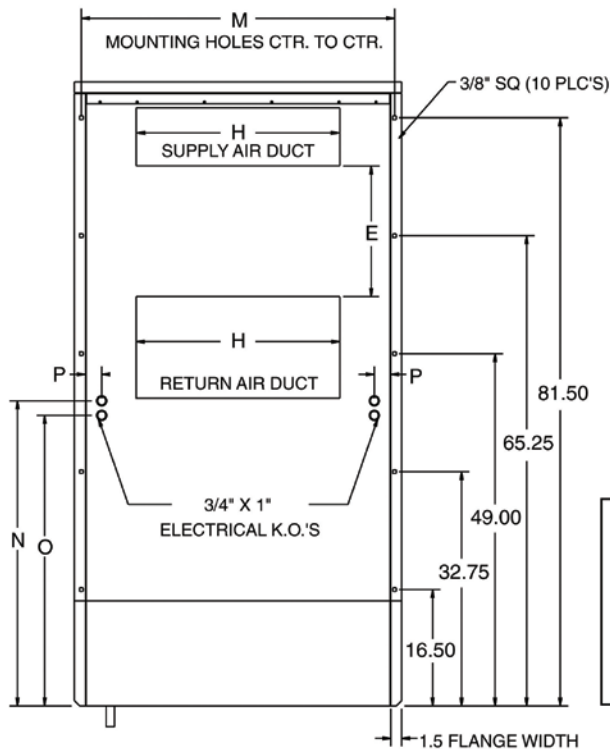

BACK VIEW

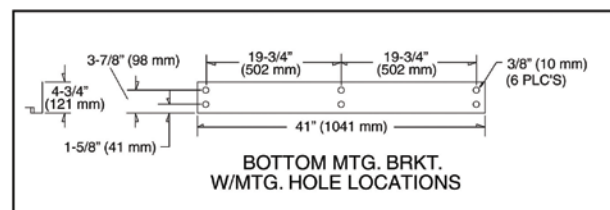

Dimensional Data - Cabinet L

For matching existing AVP24 wall opening with new AVPA42/48/60 & AVHA42/48/60
 For Non-Economizer models Only. For Economizer-Equipped models, use transition curb in Options section.

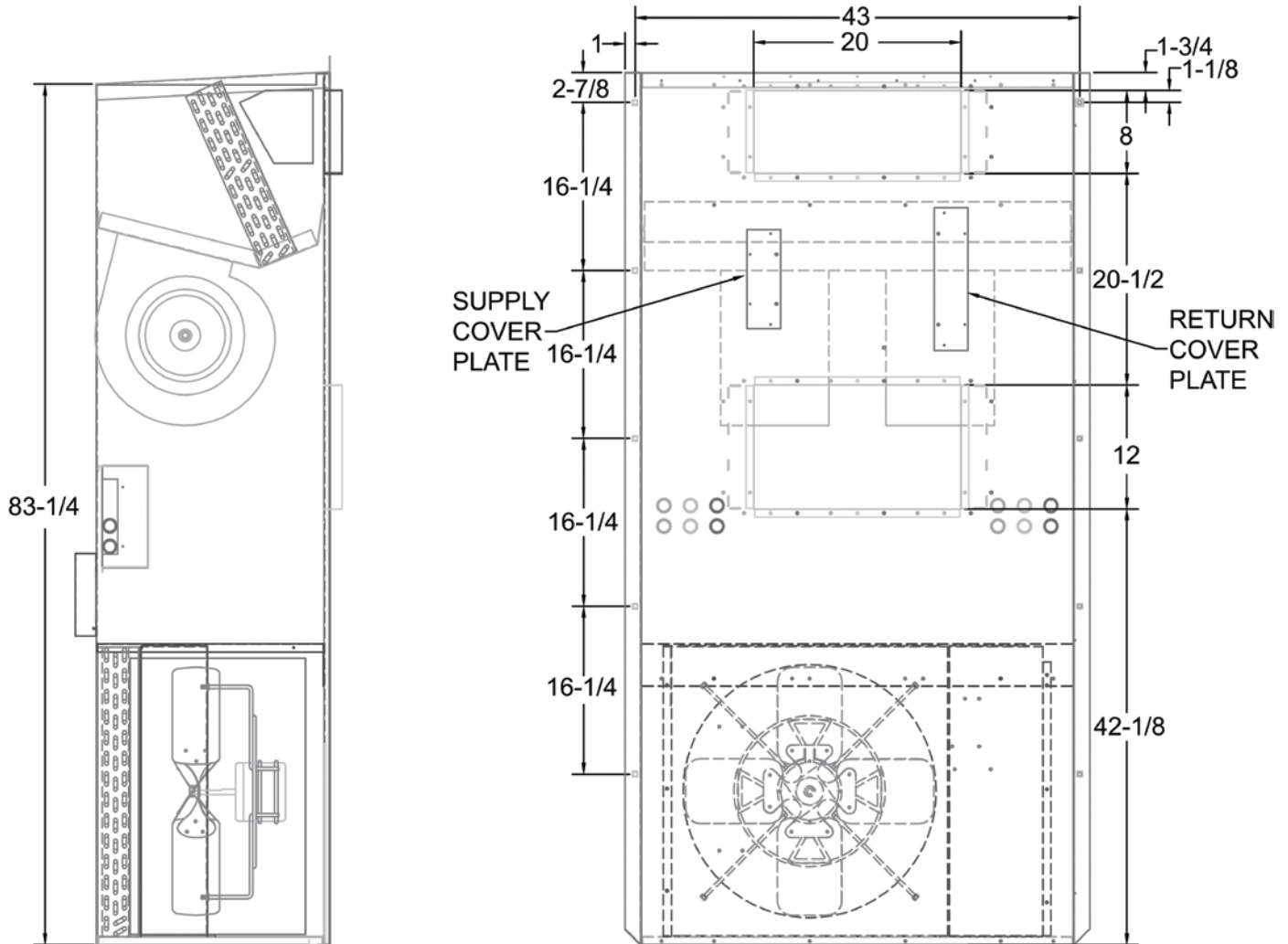

NOTES:

UNIT IS SHIPPED FROM THE FACTORY WITH SUPPLY AND RETURN LINES CENTERED LEFT TO RIGHT ON BACK PANEL. RETURN AND SUPPLY OPENINGS MAY BE SHIFTED 2-9/16" LEFT OR RIGHT TO ALLOW FOR A BETTER FIT. A SLOTTED HOLE PATTERN IS PROVIDED TO ASSIST WITH CUT OUT OF OPENINGS AND COVER PLATES ARE ALSO PROVIDED TO COVER EXCESSIVE HOLES LEFT IN BACK PANEL AFTER MAKING CUT OUTS.



Please consult the Marvair® website at www.marvair.com for the latest product literature. Detailed dimensional data is available upon request. A complete warranty statement can be found in each product's Installation/Operation Manual, on our website or by contacting Marvair at 229-273-3636. As part of the Marvair continuous improvement program, specifications are subject to change without notice.



P.O. Box 400 • Cordele, GA 31010
 156 Seedling Drive • Cordele, GA 31015
 Ph: 229-273-3636 • Fax: 229-273-5154
 Email: marvair@airxcel.com • Internet: www.marvair.com

