

## VisionPRO® Series with RedLINK™ Installation Guide



### Wired Directly to Equipment



Dual Powered - C Wire or Battery  
(C wire or Wire Saver required to use RedLINK accessories)

OR

### RedLINK to Equipment Interface Module



2 Wires for Power or  
Battery Only (no wires)



OR

### RedLINK to TrueZONE Wireless Adapter



2 Wires for Power or  
Battery Only (no wires)



## Reference to key features

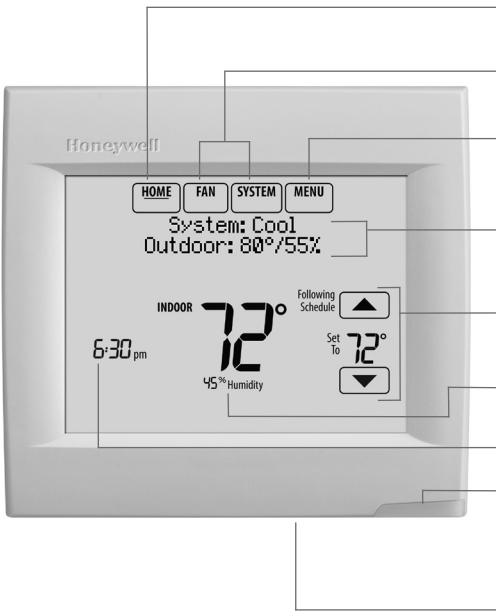

**Current display.** Underlined label signifies the current display.

**Mode control buttons.** Use to change settings for Fan or System Heat/Cool.

**Menu.** Select options to: set schedules, view equipment status, change IAQ settings, access installer options\*, etc.

**Current status.** Shows system mode (heat/cool), outdoor temperature and humidity (with optional outdoor sensor).

**Current schedule.** Shows desired temperature and schedule status.

**Indoor conditions.** Shows indoor temperature and humidity.

**Current Time.**

**Alert Light.** On when alert message is active or system is set to Em Heat. Flashes for battery-only power; on continuous for 24 VAC.

**microSD Card Port.** Use card to load settings and dealer information.

\* Password is the date code.

## Getting started

Follow these basic steps to install this thermostat, link it with the wireless accessories, and set installer options.

- 1 Installing the thermostat
- 2 Powering optional RedLINK accessories
- 3 Performing initial setup
- 4 Finding your password (Date Code)
  - To add or remove RedLINK accessories
  - To make changes to Installer Setup
  - To perform an Installer Test

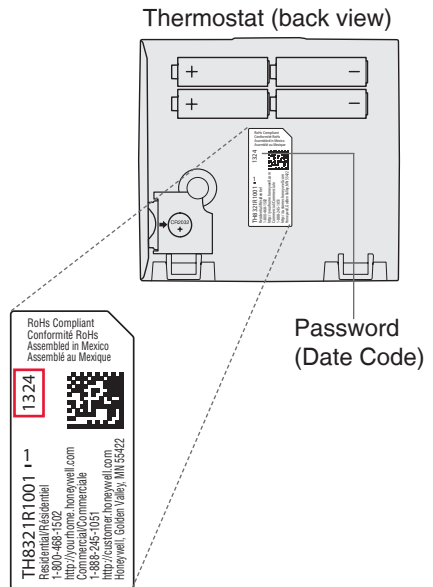

# 1 Installing the thermostat

**NOTE:** For best RedLINK performance, mount thermostats at least 2 feet apart.

## 1.1 Separate wallplate from thermostat.

Press button on top and pull to remove the wallplate.

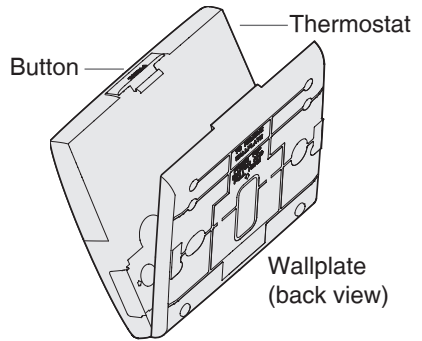

## 1.2 Mount wallplate as shown.

Mount new wallplate using screws and anchors included with the thermostat.

Drill 3/16-in holes for drywall.

Drill 7/32-in holes for plaster.

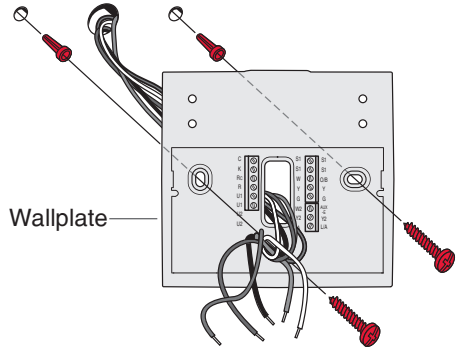

## 1.3 Connect power.

1.3a Insert supplied AA alkaline batteries for primary or backup power.

**NOTE:** When the thermostat is NOT used with the Equipment Interface Module or the TrueZONE Wireless Adapter, a C wire is required for RedLINK.

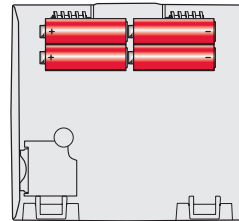

Thermostat (back view)

1.3b For 24VAC primary power, connect common side of transformer to C terminal.

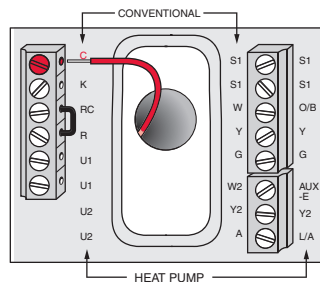

## 1.4 Wire the thermostat.

### Is the thermostat wired directly to the equipment?

- If the thermostat is wired directly to the equipment:
  - a Refer to the table and wiring diagrams on the next page.
  - b Turn on 24VAC **NOW**. 24VAC (C wire) is required to connect RedLINK accessories.

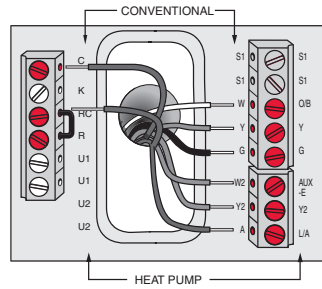

- If the thermostat is used with an Equipment Interface Module or TrueZONE Wireless Adapter, power the thermostat using Rc and C terminals or with batteries.



**NOTE:** The relay outputs and inputs on the thermostat do not function when used with an Equipment Interface Module or TrueZONE Wireless Adapter.

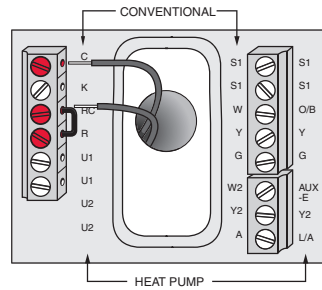

## 1.5 Remove coin cell battery tab

1.5a Remove tab to activate coin cell battery.



**NOTE:** Coin cell battery saves time and date during a power loss.

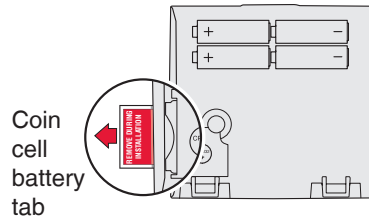

## 1.6 Mount thermostat on wallplate.

Align thermostat at bottom and snap into place as shown.

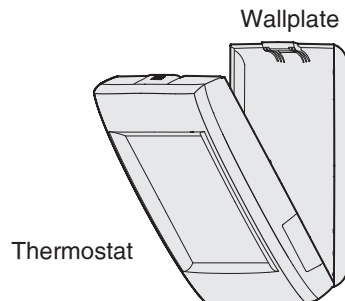

# Terminal Designations

Conventional System		Heat Pump	
Terminal	Description	Terminal	Description
C	Common wire from secondary side of cooling transformer (if 2 transformers).	C	Common wire from secondary side of cooling transformer.
Rc*	Cooling power.	Rc	Cooling power.
R*	Heating power.	R	Heating power.
W	Heat Stage 1	O/B	Changeover valve for heat pumps.
W2	Heat Stage 2	AUX-E	Backup Heat/Emergency Heat
Y	Compressor Stage 1	Y	Compressor Stage 1
Y2	Compressor Stage 2	Y2	Compressor Stage 2
G	Fan Relay	G	Fan Relay
A	Connect to Economizer Module or Lighting Panel (TOD).	L/A	Connect to Compressor Monitor, Zone Panel, Economizer Module or Lighting Panel (TOD).
U1 / U1	Universal relay for humidification, dehumidification, ventilation, or a stage of heating/cooling.	U1 / U1	Universal relay for humidification, dehumidification, ventilation, or a stage of heating/cooling.
S1 / S1	Universal input for a wired indoor, outdoor or discharge sensor.	S1 / S1	Universal input for a wired indoor, outdoor or discharge sensor.
K**	Connect to K on Wire Saver module.	K**	Connect to K on Wire Saver module.

\* Remove factory installed jumper for two transformer systems.

\*\* The THP9045A1023 Wire Saver module is used on heat/cool systems when you only have four wires at the thermostat and you would like the thermostat to be powered with a common wire. Use the **K terminal** in place of the Y and G terminals on conventional or heat pump systems to provide control of the fan and the compressor through a single wire—the unused wire then becomes your common wire. See THP9045 instructions for more information.

## POWERED HUMIDIFIER, DEHUMIDIFIER OR VENTILATOR

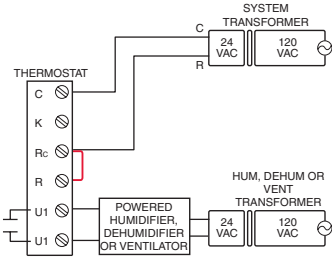

## NON-POWERED HUMIDIFIER, DEHUMIDIFIER OR VENTILATOR

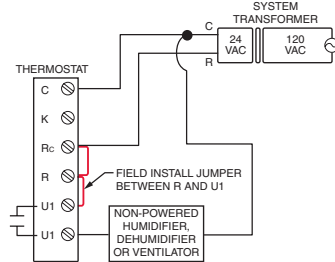

## DEHUMIDIFICATION WITH LOW SPEED FAN

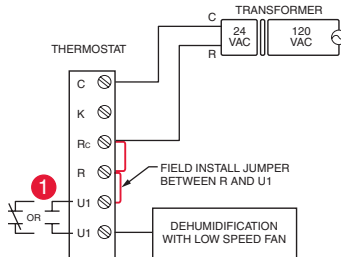

- 1 Wire the thermostat universal relay to the low speed fan for dehumidification control at the equipment. The thermostat relay can be set to normally open or normally closed in the thermostat installer setup.

Normally open, dry contacts

Normally closed, dry contacts

## CONNECTING A HEAT OR COOL STAGE TO U1

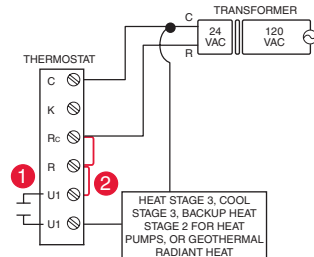

- 1 U1 terminals are normally open dry contacts when set up for a stage of heating or cooling.
- 2 You must install a field jumper if the stage of heating or cooling is powered by system transformer. Do NOT install a field jumper if the stage of heating has its own transformer.

## 2 Powering optional RedLINK accessories

### 2.1 Install batteries in RedLINK accessories.

- Portable Comfort Control
- Wireless Outdoor Sensor\*
- Wireless Indoor Sensor\*
- Wireless Entry/Exit Remote\*
- Wireless Vent and Filter Boost Remote\*

\* Requires setup. See Installer Setup options in Step 3.4.

### 2.2 Connect gateway to internet and connect to power.

2.2a Connect RedLINK Internet Gateway to router or modem with Ethernet cable (RJ45).

2.2b Connect gateway's power cord to an electrical outlet that is not controlled by a wall switch.

**NOTE:** If the thermostat is wired directly to the equipment, 24VAC (C wire) is required to connect RedLINK accessories. Turn on 24VAC before performing initial setup in Step 3.

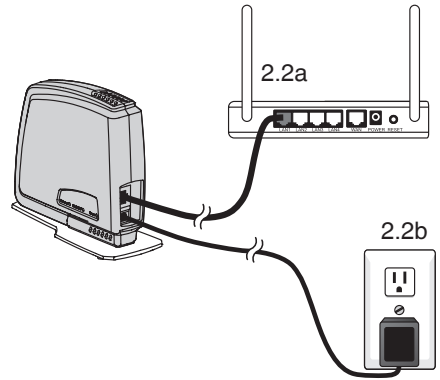

## 3 Performing initial setup

Initial setup options define the type of system you are installing:

- Residential or commercial
- Non-zoned or zoned
- Used with or without an Equipment Interface Module (THM5421)
- Used with or without the TrueZONE Wireless Adapter (THM4000)

### 3.1 Follow prompts on the screen to select the appropriate options.

**NOTE:** If you are connecting the thermostat to the TrueZONE Wireless Adapter (THM4000), refer to the TrueZONE instructions to link the thermostat and RedLINK accessories. Then go to Step 3.4.



### 3.2 When you see the prompt Connect RedLINK Accessories? Touch No or Yes.

- If you select **No**, continue to Step 3.4.
- If you select **Yes**, you will be prompted to Press Connect on New Accessories. Continue to Step 3.3.



### 3.3 Connect each RedLINK accessory.

 **NOTE:** Accessories must be at least 2 feet away from the thermostat during the linking process.

- 3.3a While the Press Connect message is displayed (listening mode), **press and quickly release** the CONNECT button on each new RedLINK accessory.
- 3.3b After a short delay (up to 15 seconds), check thermostat to confirm the connection of each RedLINK accessory. Touch ▲ or ▼ to review the list.
- 3.3c Touch **Done** at the thermostat after all new RedLINK accessories are connected.

 **NOTE:** Thermostat displays a countdown timer while in the listening mode. If it detects no activity for 15 minutes, it exits listening mode.

### 3.4 Finish the initial setup.

Finish the setup by selecting the desired options. Touch **Done** after you select the last option you want to change.

The thermostat now displays its Home screen and the **thermostat setup is complete.**



Listening mode

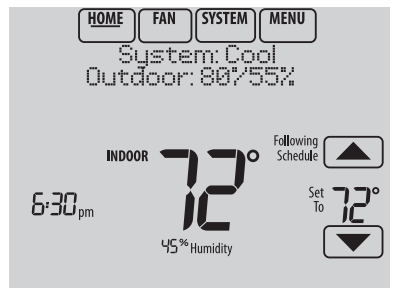

# 4 Finding your password (Date Code)

- To add or remove RedLINK accessories
- To make changes to Installer Setup
- To perform an Installer Test

## Finding your password

You can find the date code on the back of the thermostat, or

1 Touch **Menu**.

2 Select **Dealer Information**.

3 Scroll down to see the Date Code.

## Linking RedLINK accessories to the thermostat

1 Touch **Menu**.

2 Select **Installer Options**.

3 Enter password (date code) and touch **Done**.

4 Select **Wireless Manager**.

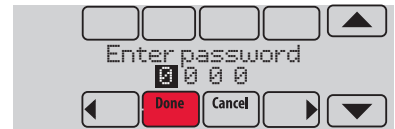
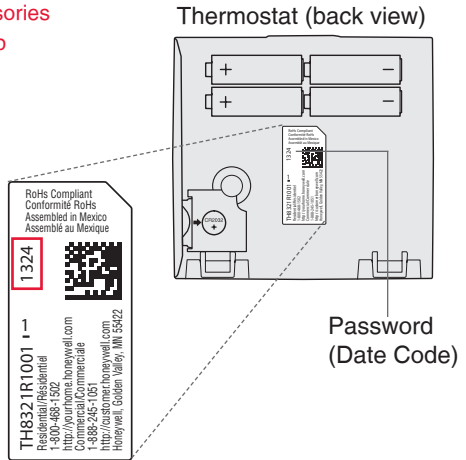



- 5 Select **Add Device**. The screen displays “Press Connect on New Accessories.” The thermostat is now in listening mode.

 **NOTE:** Accessories must be at least 2 feet away from the thermostat during the linking process.

- 5a **Press and quickly release** the CONNECT button on each new RedLINK accessory.

- 5b After a short delay (up to 15 seconds), check thermostat to confirm the connection of each RedLINK accessory. Touch ▲ or ▼ to review the list.

- 5c Touch **Done** at the thermostat after all new RedLINK accessories are connected.

 **NOTE:** Thermostat displays a count-down timer while in the listening mode. If it detects no activity for 15 minutes, it exits listening mode.



Listening mode



## Making changes to Installer Setup and performing an Installer Test

 **NOTE:** Use a microSD card to save set up time. See next page.

- 1 Touch **Menu**.
- 2 Select **Installer Options**.
- 3 Enter password (date code) and touch **Done**.
- 4 Select **Installer Setup** or **Installer Test**.
- 5 Follow prompts on the screen to select the desired setup options or to perform an equipment test.

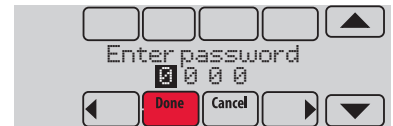



## Using a microSD card for setup, data logs and software upgrades

Use a microSD (secure digital) card to save setup time by loading Installer Setup settings, Dealer Information, Holiday Schedules, and Custom Reminders to multiple thermostats. For troubleshooting help, you can save the thermostat Data Logs (Alerts Log and Interaction Log) to a microSD card - then view them on your computer. Also use the microSD card to upgrade the thermostat software.

### Loading Dealer Information and New Thermostat Software:

- 1 Visit <http://thermostatsetup.honeywell.com> to enter your dealer information or load new thermostat software.
- 2 Connect a **microSD USB Adapter** to your computer to download the file(s).
- 3 After the file(s) are downloaded, remove the microSD card from the adapter and insert into thermostat.

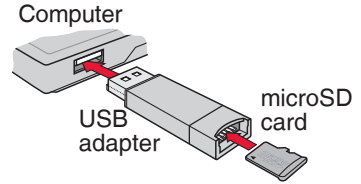

### To use the microSD card in the thermostat:

- 1 Slide card into the bottom of thermostat.
- 2 Select the item to load or save.
- 3 Follow the prompts on the screen.
  - To add information from the card to the thermostat, select **Load from SD Card**.
  - To put thermostat information on the card, select **Save to SD Card**.
- 4 When you are finished, touch **Done**, then **Home**, and remove the microSD card.

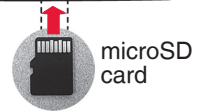
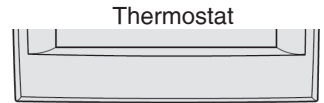

## To replace a thermostat

When you replace a thermostat, you must reset the RedLINK accessories before connecting them to the new thermostat. Follow the instructions below:

### At the Portable Comfort Control:

Press and hold the blank space (or arrow) in the lower right hand corner of the screen until the display changes (hold for about 4 seconds). Press REMOVE, then YES to disconnect from the old thermostats. To reconnect the thermostat, go to Step 3.2.

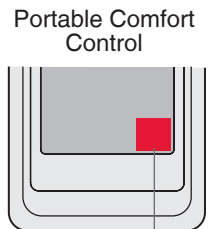

Press and hold

### At the Indoor Sensor, RedLINK Internet Gateway, Entry/Exit Remote, Vent-Filter Boost Remote or TrueSTEAM Wireless Adapter:

Press and hold the CONNECT button on the accessory until the status light glows amber (hold for about 10 seconds). To reconnect the thermostat, go to Step 3.2.

### At the Equipment Interface Module (EIM):

Press and hold the CONNECT button on the EIM until the CONNECTED LED glows amber (hold for about 10 seconds). Follow the prompts on the screen to connect the new thermostat to the EIM.

# Specifications and replacement parts

## Operating Ambient Temperature

- Thermostat:** 32 to 120° F (0 to 48.9° C)
- Portable Comfort Control:** 32 to 120° F (0 to 48.9° C)
- Wireless Outdoor Sensor:** -40 to 140° F (-40 to 60° C)
- Wireless Indoor Sensor:** 0 to 120° F (-17.8 to 48.9° C)
  - For Optimal Battery Life: 35 to 114° F (1.7 to 45.6° C)
- Equipment Interface Module:** -40 to 165° F (-40 to 73.9° C)
- Return Air Sensor:** 0 to 200° F (-17.8 to 93.3° C)
- Discharge Air Sensor:** 0 to 200° F (-17.8 to 93.3° C)
- RedLINK Internet Gateway:** 32 to 120° F (0 to 48.9° C)

## Operating Relative Humidity

- Thermostat:** 5% to 90% (non-condensing)
- Portable Comfort Control:** 5% to 90% (non-condensing)
- Wireless Outdoor Sensor:** 0% to 100% (condensing)
- Wireless Indoor Sensor:** 5% to 90% (non-condensing)
- Equipment Interface Module:** 5% to 95% (non-condensing)
- RedLINK Internet Gateway:** 5% to 95% (non-condensing)

## Physical Dimensions (height, width, depth)

- Thermostat:** 4-15/16 x 4-5/8 x 1-1/8 inches (126 mm x 118 mm x 29 mm)
- Equipment Interface Module:** 9-5/16 x 4-13/16 x 1-19/32 inches (91 x 147 x 42 mm)
- Wireless Outdoor Sensor:** 5 x 3-1/2 x 1-11/16 inches (127 x 89 x 43 mm)
- Wireless Indoor Sensor:** 2-7/8 x 1-7/8 x 15/16 inches (74 x 48 x 24 mm)
- Portable Comfort Control:** 6-1/4 x 3-1/8 x 1-5/8 inches (158 x 80 x 38 mm)
- RedLINK Internet Gateway:** 6 x 4-7/8 x 2-1/2 inches (152 x 124 x 64 mm)

## RedLINK Communication

- Frequency:** 900 Mhz frequency range
- Re-Sync Time:** RedLINK devices re-establish communication within 6 minutes after AC power resumes.

## Electrical ratings

Terminal	Voltage (50/60 Hz)	Max. Current Rating
W - OB	18 to 30 VAC and 750 mVDC	1.00A
Y (cooling)	18 to 30 VAC	1.00A
G (fan)	18 to 30 VAC	0.50A
W2 - Aux (heating)	18 to 30 VAC	0.60A
Y2 (cooling)	18 to 30 VAC	0.60A
A-L/A (output)	18 to 30 VAC	1.00A
U1/U1	30 VAC max.	0.50A

## Accessories and replacement parts

Accessories / Replacement Parts	Part Number
Equipment Interface Module	YTHM5421R1010, THM5421R1021
Wireless Adapter for TrueZone, TrueSteam, or extend wireless range of EIM	THM4000R1000
RedLINK Internet Gateway	THM6000R1002
Wireless Entry/Exit Remote	REM1000R1003
Wireless Vent and Filter Boost Remote	HVC20A1000
Portable Comfort Control	REM5000R1001
Wireless Outdoor Sensor	C7089R1013
Wireless Indoor Sensor	C7189R1004
Wireless Outdoor Sensor 10k ohm NTC	C7089U1006
Wired Wall-mount Indoor Sensor 10k ohm NTC	C7189U1005
Wired Flush-mount Indoor Sensor 20k ohm NTC	C7772A1004, C7772A1012
Wired Wall-mount Indoor Sensor 20k ohm NTC	TR21
Wired Wall-mount Indoor Sensor 10k ohm NTC	TR21-A
Supply or Return Air Sensor 10k ohm NTC	C7735A1000
Supply or Return Air Sensor 20k ohm NTC	C7041
Supply or Return Air Sensor 20k ohm NTC	C7770A1006
Cover Plate (covers marks left by old thermostats)	THP2400A1019
Wire Saver Module	THP9045A1023

Model Numbering	TH8321	TH8320	TH8110
Stages	3H/2C HP 2H/2C CONV	3H/2C HP 2H/2C CONV	1H/1C HP 1H/1C CONV
Residential or Commercial	✓	✓	✓
Dual Powered - C Wire or Battery	✓	✓	✓
Onboard Humidity Sensor	✓		
Number of Universal Relays	1	0	0
Number of Universal Sensor Inputs	1	1	1
Economizer / TOD Output	✓	✓	
Works with Optional Equipment Interface Module*	✓	✓	✓
Works with Optional TrueZONE Wireless Adapter*	✓	✓	✓

\* The relay outputs and inputs on the thermostat do not function when used with an Equipment Interface Module or the TrueZONE Wireless Adapter.

\* If the thermostat has been setup WITHOUT an Equipment Interface Module or the TrueZONE Wireless Adapter and you would like to add one, you must reset the thermostat back to factory defaults. Press **MENU > Installer Options >** scroll down to select **Reset to Defaults.**

**⚠ DISCONNECT POWER BEFORE INSTALLATION.** Can cause electrical shock or equipment damage.

**⚠ This thermostat contains a Lithium battery which may contain Perchlorate material.** Perchlorate Material—special handling may apply. See [www.dtsc.ca.gov/hazardouswaste/perchlorate](http://www.dtsc.ca.gov/hazardouswaste/perchlorate)

**⚠ MERCURY NOTICE:** If this product is replacing a control that contains mercury in a sealed tube, do not place the old control in the trash. Contact the Thermostat Recycling Corporation at [www.thermostat-recycle.org](http://www.thermostat-recycle.org) or 800-238-8192 for information on how and where to properly and safely dispose of your old thermostat.

**PRO install** **Must be installed by a trained, experience technician.** Read these instructions carefully. Failure to follow these instructions can damage the product or cause a hazardous condition.

## Need Help?

For assistance please visit

<http://customer.honeywell.com>,

or call toll-free:

**1-800-468-1502** (residential installation)

**1-888-245-1051** (commercial installation)



Scan for more information

## Automation and Control Systems

Honeywell International Inc.

1985 Douglas Drive North

Golden Valley, MN 55422

<http://customer.honeywell.com>

# Honeywell

