

Submittal Data: VIR12HP230V1B 12,000 BTU/H (208/230V) Wall Mounted Heat Pump System

Job Name	Location	Date
Purchaser	Engineer	
Submitted To	For	<input type="checkbox"/> Reference <input type="checkbox"/> Approval <input type="checkbox"/> Construction
Unit Designation	Schedule No.	

GENERAL FEATURES

- Compact and Quiet Design
- High Efficiency DC Inverter Technology
- Wireless Remote with LCD Display
- Wi-Fi Ready (Sold Separately Kit PN: WSBE02)
- XK-41 Wired Tether Controller (Sold Separately)
- Low Ambient Cool to 0 deg F
- Blue Fin Condenser Coil
- 5 year Limited Parts Warranty



System Ratings	Indoor Unit Data
----------------	------------------

Cooling	
Rated Capacity	12,000 BTU/H
Capacity Range	3,100-13,000 BTU/H
Power Input (Max)	1,350 W
SEER	22.0
EER	12.5
Heating at 47° F	
Rated Capacity	13,000 BTU/H
Capacity Range	2,400-14,000 BTU/H
Power Input (Max)	1,400 W
HSPF	11.0
COP	3.5
Heating at 17° F	
Rated Capacity	7,100 BTU/H
Operating Range	
Cooling	(Max) 115°F (46 C)
	(Min) 0°F (-18 C)
Heating	(Max) 75°F (24 C)
	(Min) -4°F (-20 C)

Fan Motor	Type	Cross-Flow
	Output Power	20 W
	FLA	0.1 A
Airflow		
Cooling	Wet (Lo/Hi)	171/400 CFM
Heating	Dry (Lo/Hi)	171/400 CFM
Sound Pressure Level		
Cooling	(Min/Max)	29/45 db(A)
Heating	(Min/Max)	29/45 db(A)
Dehumidification		2.96 pt/hr

Refrigerant Piping Data

Gas Pipe Size (OD)	1/2-in
Liquid Pipe Size (OD)	1/4-in
Connection Method	Flared
Factory Charge	47.6 oz
Additional Charge	0.21 oz/ft
Pre-Charge Length	25-ft
MAX Refrigerant Pipe Length	66-ft
MIN Refrigerant Pipe Length	10-ft
MAX Refrigerant Pipe Elevation	33-ft

Outdoor Unit Data

Compressor	Type	DC Inverter Driven Rotary
	RLA	6.6 A
Refrigerant Type		R410A
Fan Motor	Output Power	30 W
	FLA	0.36 A

Sound Pressure	Cooling/Heating	54/54 db(A)
-----------------------	-----------------	-------------

Electrical Data

Power Supply	
Normal Operational Voltage	208/230 V, 1 Phase, 60 Hz
Voltage Range	187 - 253 V
MCA	9.0 A
MOCP/Breaker Size	15 A
Main Power Wire Size	14-2 AWG

SYSTEM FEATURES	
Inverter Type	G10
Ultra Low Frequency Torque Control	Yes
Power Factor Correction	Yes
Compressor Type	High Eff. Rotary
Refrigerant Type	R410A
Basepan With Electric Heater	NO
Compressor With Electric Heater	YES
Outdoor Fin Coating	Bule Fin
Intelligent Defrosting	YES
Intelligent Preheating	YES
Low Voltage Startup	YES
Memory/Power Failure Recovery	YES
Self Diagnosis	YES
Wired Controller Interface (XK-41)	YES
Wi-Fi Interface Capable	Optional (see PN: WSBEC01)
Indoor Fan Type	Crossflow
Multi Fan Speeds	4 Speeds
Indoor Unit Display	YES
Advance Filter	Optional (see Filter Kits)
Auxiliary Electrical Heater	NO
Ventilation (Outdoor Air)	NO

REMOTE CONTROLLER FUNCTIONS	
Auto Mode	YES
Auto Fan	YES
Auto Swing (Horizontal Auto Swing)	NO
Auto Swing (Vertical Auto Swing)	YES
Clock on Remote Controller	YES
Dry Mode	YES
Dry Anti-Mildew (X-Fan) Mode	NO
Energy Saving Mode	YES
Dirty Filter Alert	NO
I Feel Function	YES
Lock on Remote Controller	YES
Quiet Mode	NO
Room Temperature Display	YES
Sleep Mode	YES
4 Sleep Modes Options	NO
Timer Mode	YES
Turbo Mode	YES
Display On/Off Control	YES
Freeze Guard Mode	YES
Display On/Off Control	YES
Freeze Guard Mode	YES

COOLING PERFORMANCE (BtuH)*

Outdoor Ambient DB	Indoor Ambient Temperature							
	68F DB (20C)		73F DB (23C)		80F DB (27C)		82F DB (28C)	
	57F WB (14C)		61F WB (16C)		67F WB (19C)		68F WB (20C)	
	TC	SHC	TC	SHC	TC	SHC	TC	SHC
5°F	7,656	6,005	8,088	6,341	9,128	7,159	9,508	7,458
14°F	7,852	6,159	8,292	6,503	9,476	7,431	9,871	7,740
23°F	8,388	6,580	8,972	7,038	10,280	8,063	10,708	8,399
32°F	10,172	7,978	10,880	8,533	11,916	9,343	12,413	9,732
41°F	11,520	9,035	12,240	9,598	13,080	10,259	13,625	10,686
50°F	11,384	8,930	12,108	9,497	12,960	10,166	13,500	10,589
59°F	11,104	8,707	11,824	9,274	12,840	10,072	13,375	10,492
68°F	10,824	8,488	11,544	9,055	12,600	9,882	13,125	10,294
77°F	10,548	8,273	11,264	8,833	12,360	9,696	12,875	10,100
86°F	10,244	8,034	10,960	8,594	12,000	9,412	12,500	9,804
95°F	9,996	7,840	10,708	8,399	11,844	9,290	12,338	9,678
104°F	9,748	7,645	10,460	8,205	11,688	9,169	12,175	9,551
113°F	9,248	7,252	9,960	7,812	11,192	8,776	11,658	9,142

HEATING PERFORMANCE (BtuH)*

Outdoor Ambient DB	Indoor Ambient Temperature							
	68F DB (20C)		73F DB (23C)		80F DB (27C)		86F DB (30C)	
	57F WB (14C)		61F WB (16C)		67F WB (19C)		72F WB (22C)	
	TC	SHC	TC	SHC	TC	SHC	TC	SHC
-4°F	6,821	6,821	6,756	6,756	6,642	6,642	6,374	6,374
0°F	7,390	7,390	7,321	7,321	7,199	7,199	6,902	6,902
6°F	7,796	7,796	7,723	7,723	7,593	7,593	7,280	7,280
10°F	8,121	8,121	8,044	8,044	7,910	7,910	7,585	7,585
16°F	8,365	8,365	8,288	8,288	8,149	8,149	7,812	7,812
19°F	8,531	8,531	8,446	8,446	8,308	8,308	7,963	7,963
24°F	9,478	9,478	9,397	9,397	9,254	9,254	8,913	8,913
32°F	10,583	10,583	10,502	10,502	10,359	10,359	10,018	10,018
41°F	11,846	11,846	11,765	11,765	11,627	11,627	11,282	11,282
43°F	12,163	12,163	12,082	12,082	11,940	11,940	11,598	11,598
47°F	13,264	13,264	13,130	13,130	12,903	12,903	12,342	12,342
53°F	13,398	13,398	13,260	13,260	13,028	13,028	12,464	12,464
59°F	13,703	13,703	13,565	13,565	13,325	13,325	12,748	12,748
64°F	13,995	13,995	13,853	13,853	13,609	13,609	13,020	13,020
70°F	14,259	14,259	14,113	14,113	13,869	13,869	13,268	13,268
75°F	14,458	14,458	14,312	14,312	14,060	14,060	13,451	13,451

* Maximum system capacity

TC- Total Capacity (BtuH)

SHC- Sensible Capacity (BtuH)

MINIMUM SPACING REQUIREMENTS

Units: inch (mm)

INDOOR

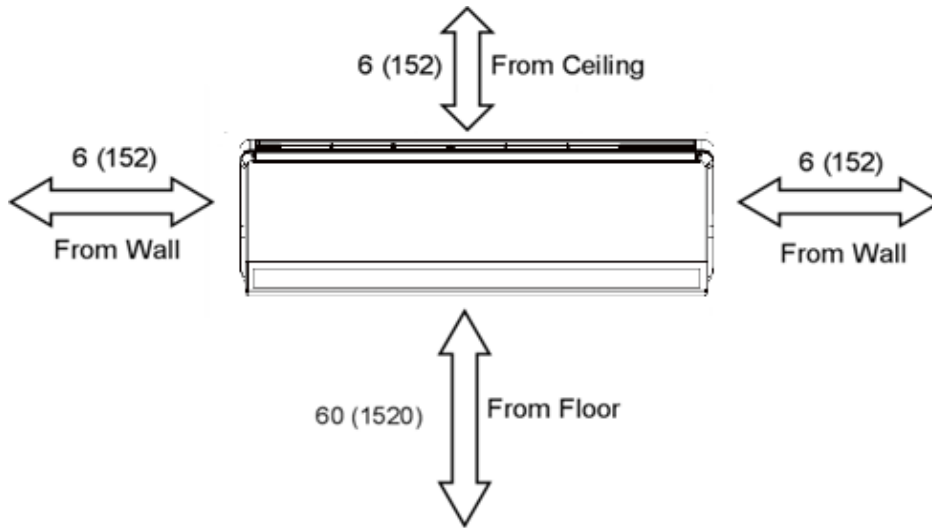

Units: inch (mm)

OUTDOOR

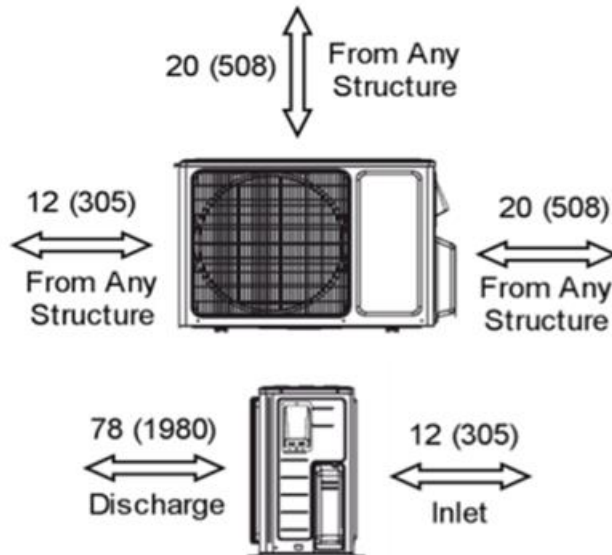

DIMENSIONAL SPECIFICATIONS

VIR12HP230V1B

INDOOR UNIT DIMENSIONS

Units: inch

Model No: VIR12HP230V1BH

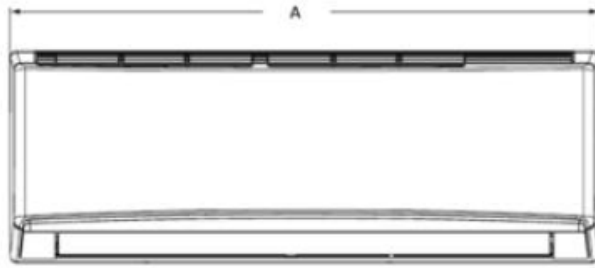

Dimensions	
A	33.4
B	11.4
C	8.2

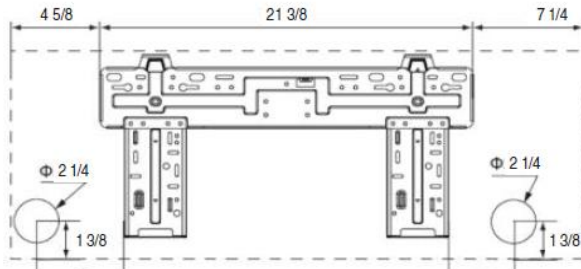

Weight (Net/Gross) 22.1/26.5 lbs

Liquid Line Valve	1/4-in OD Flared
Gas Line Valve	1/2-in OD Flared
Drain Connector	5/8-in OD

OUTDOOR UNIT DIMENSIONS

Units: inch

Model No: VIR12HP230V1BO

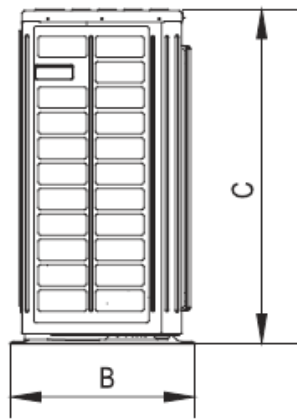
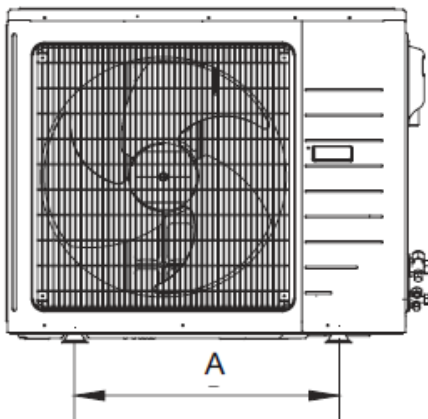

Dimensions	
A	21.3
B	12.6
C	21.3
D	33.4
E	11.3

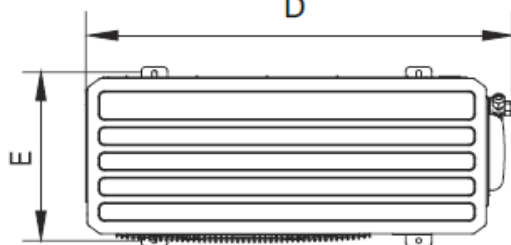

Weight (Net/Gross) 86.0/93.0 lbs

Liquid Line Valve	1/4-in OD Flared
Gas Line Valve	1/2-in OD Flared

Notes:

1. Recommended Interconnecting Cable Type 14 AWG-4 Stranded Copper Conductors THHN 600V Wire
2. Power wiring cable size must comply with applicable national and local codes.
3. Test conditions are based on AHRI 210/240.

Specifications are subject to change without notice. Manufacturer reserves the right to discontinue or modify specifications or designs without notice or without incurring obligations. All rights reserved.