

Submittal Data: UMAT24HP230V1AD 24,000 BTUH Slim Duct Heat Pump System

Job Name Location Date

Purchaser Engineer

Submitted To For Reference Approval Construction

Unit Designation Schedule No.

- GENERAL FEATURES**
- Multi-Speed Fan
 - Medium Static Pressure Capability
 - Return Air From Rear Only
 - Internal Condensate Drain Pump
 - Sentry Condensate Overflow Protection
 - XK60 Wired Remote Controllers
 - Acrylic Resin/Anti-Corrosion Fin Coating
 - 5 yr. Limited Parts Warranty
 - 7 year Limited Compressor Warranty



System Ratings

Cooling		
Rated Capacity		23,800 BTU/H
Capacity Range		7,400-29,000 BTU/H
Power Input (Max)		2,500 W
SEER		16.0
EER		10.7
Heating at 47° F		
Rated Capacity		27,200 BTU/H
Capacity Range		8,200-32,400 BTU/H
Power Input (Max)		2,750 W
HSPF		10.0
COP		3.4
Heating at 17° F		
Rated Capacity		16,700 BTU/H
Operating Range		
Cooling	(Max)	118°F (48°C)
	(Min)	0°F (-18°C)
Heating	(Max)	75°F (24°C)
	(Min)	0°F (-18°C)
Refrigerant Piping Data		
Gas Pipe Size (OD)		5/8-in
Liquid Pipe Size (OD)		3/8-in
Connection Method		Flared
Factory Charge		78.4 oz
Additional Charge		0.6 oz/ft
Pre-Charge Length		25-ft
MAX Refrigerant Pipe Length		164-ft
MIN Refrigerant Pipe Length		10-ft
MAX Refrigerant Pipe Elevation		49-ft

Indoor Unit Data

Fan Motor	Output Power	1/5HP
	FLA	1.3 A
Airflow		
	Cooling Wet (Lo/Hi)	570/820 CFM
	Heating Dry (Lo/Hi)	570/820 CFM
Sound Level		
	Cooling (Min/Max)	40/46 dB(A)
	Heating (Min/Max)	40/46 dB(A)
Dehumidification		0.9 pt/hr
Condensate Drain Lift (Height)		33-in
Power Supply (Dedicated Circuit: Size Per Local Code)		
	Normal Operational Voltage	208/230 V, 1 Phase, 60 Hz
	Voltage Range	187 - 253 V
	MCA	2.0A
	MOCP/Breaker Size	15A
Communication Wire Size		18-2 AWG / 300V THHN

Outdoor Unit Data

Compressor		DC Inverter Driven Rotary
	RLA	18.0 A
Refrigerant Type		R410A
Fan Motor	Output Power	1/6HP
	FLA	1.5 A
Sound Level		
	Cooling/Heating	57/57 dB(A)
Power Supply (Dedicated Circuit)		
	Normal Operational Voltage	208/230 V, 1 Phase, 60 Hz
	Voltage Range	187 - 253 V
	Main Supply Wire Size	10 AWG
	MCA	24.0A
	MOCP/Breaker Size	40 A

SYSTEM FEATURES	
Inverter Type	G10
Ultra Low Frequency Torque Control	YES
Power Factor Correction	YES
Compressor Type	Rotary
Refrigerant Type	R410A
Basepan With Electric Heater	YES
Compressor With Electric Heater	NO
Outdoor Fin Coating	Acrylic Resin
Intelligent Defrosting	YES
Intelligent Preheating	YES
Low Voltage Startup	YES
Memory/Power Failure Recovery	YES
Self Diagnosis	YES
Low Ambient Cooling	YES
Internal Condensate Pump	YES
XK60 Wired Controller Interface	YES
Wi-Fi Interface	NO
Indoor Fan Type	Centrifugal
Multi Fan Speeds	3 Speeds
LED Display Indoor Unit	NO
Advance Filter	NO
Auxiliary Electrical Heater	NO
Ventilation (Outdoor Air)	Optional

WIRED CONTROLLER FUNCTIONS	
Auto Mode	YES
Auto Fan	YES
Auto Swing (Continuous Sweep)	NO
Adjustable Swing Louvers (5 pos.)	NO
Clock on Remote Controller	YES
Dry Mode	YES
Dry Anti-Mildew (X-Fan) Mode	YES
Energy Saving Mode	NO
Dirty Filter Alert	NO
I Feel Function	YES
Lock on Wired Controller	YES
Quiet Mode	NO
Room Temperature Display (5 sec.)	YES
Sleep Mode	YES
Timer Mode	YES
Turbo Mode	YES
Display On/Off Control	NO
Freeze Guard Mode	YES

FAN PERFORMANCE CURVES

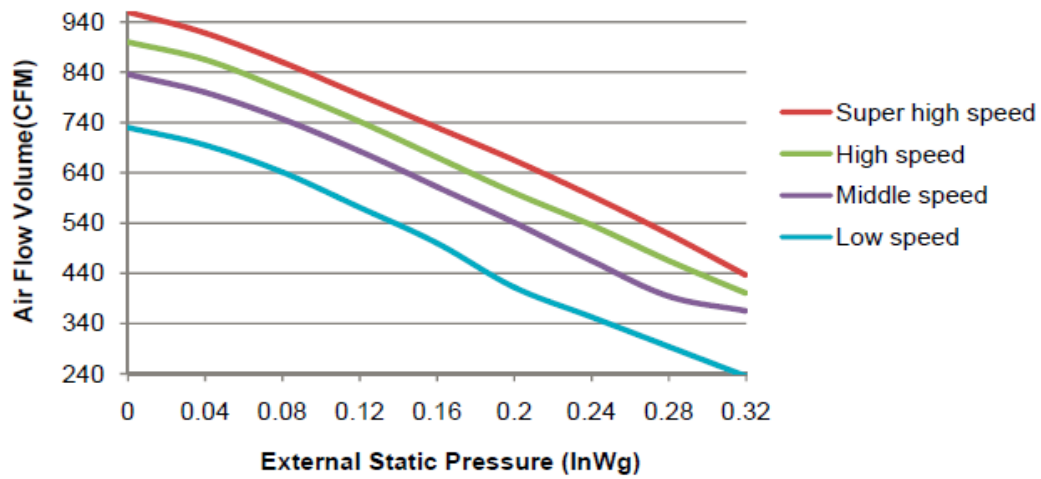

EXTENDED RATINGS

COOLING PERFORMANCE

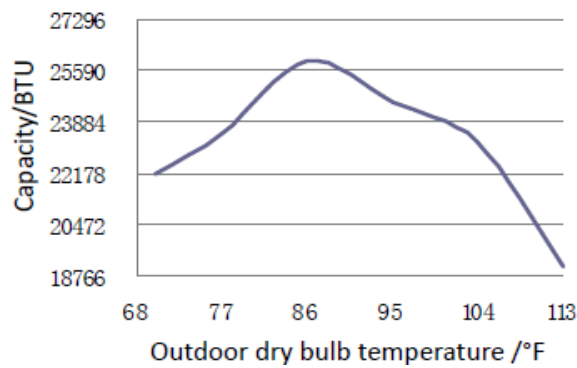

HEATING PERFORMANCE

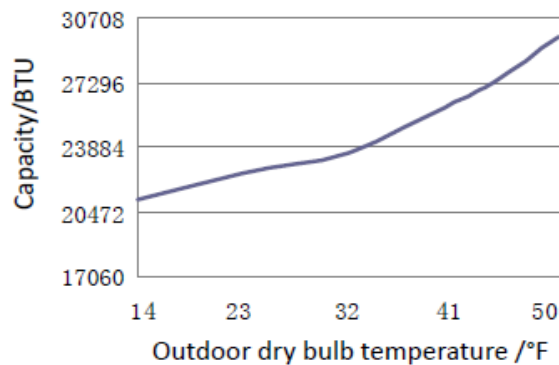

MINIMUM SPACING REQUIREMENTS

Units: inch (mm)

INDOOR

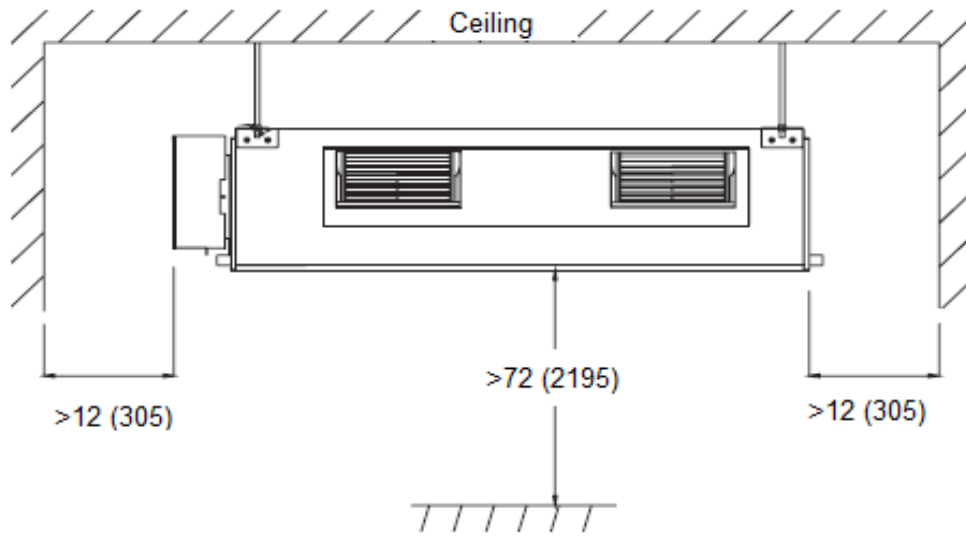

Units: inch (mm)

OUTDOOR

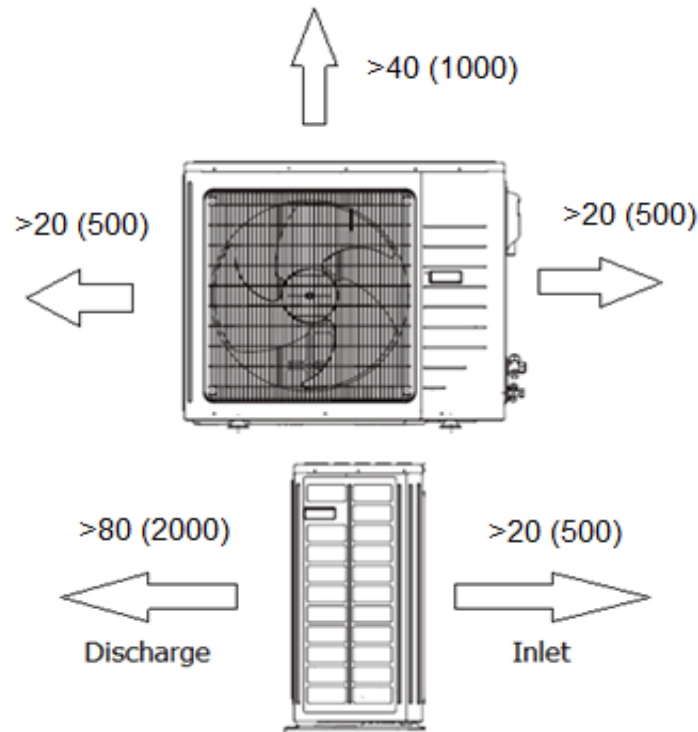

DIMENSIONAL SPECIFICATIONS

UMAT24HP230V1AD

INDOOR UNIT DIMENSIONS & WEIGHTS

Units: inch (mm)

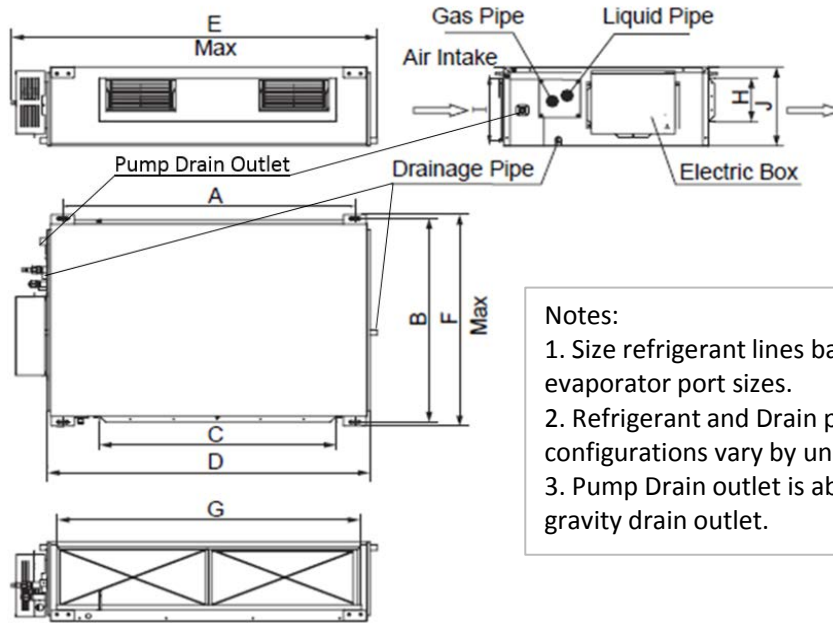

- Notes:**
1. Size refrigerant lines based on evaporator port sizes.
 2. Refrigerant and Drain pipe configurations vary by unit size.
 3. Pump Drain outlet is above gravity drain outlet.

A	43.375	(1101)
B	20.375	(517)
C	32.25	(820)
D	45.625	(1159)
E	50.38	(1279)
F	22.0	(558)
G	39.5	(1002)
H	6.25	(160)
I	9.3	(235)
J	10.5	(268)

Net Weight	74.8 lbs
Shipping Weight	85.8 lbs

Liquid Line Valve	3/8-in OD Flared
Gas Line Valve	5/8-in OD Flared
Drain Connector	13/16 in OD

OUTDOOR UNIT DIMENSIONS & WEIGHTS

Units: inch (mm)

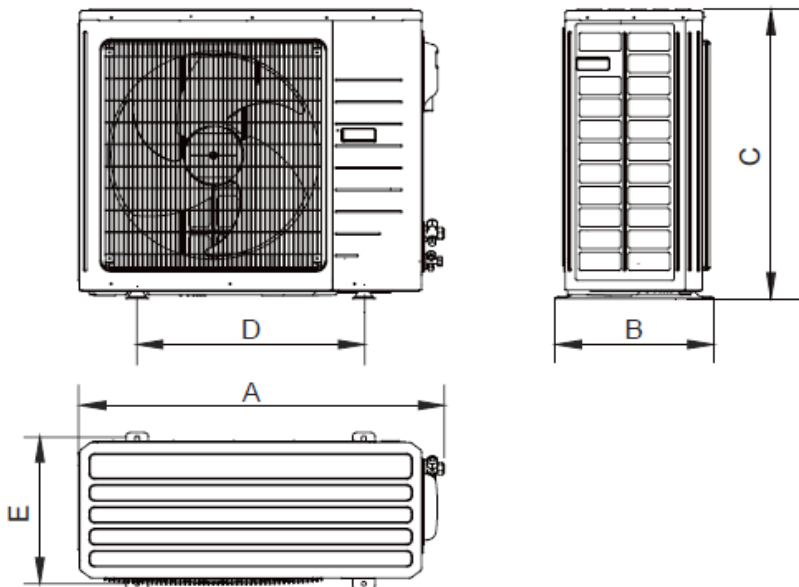

A	38.625	(980)
B	16.75	(427)
C	31.125	(790)
D	24.0	(610)
E	15.5	(395)

Net Weight	151.8 lbs
Shipping Weight	162.8 lbs

Liquid Line Valve	3/8-in OD Flared
Gas Line Valve	5/8-in OD Flared

- Notes:**
1. Recommended Communication Wire Type 18-2 AWG Stranded Copper THHN 300V Wire
 2. Power wiring size must comply with applicable national and local codes for both ID and OD dedicated circuits.
 3. Test conditions are based on AHRI 210/240.

Specifications are subject to change without notice. Manufacturer reserves the right to discontinue or modify specifications or designs without notice or without incurring obligations. All rights reserved.