

Submittal Data: MULTI30HP230V1CO 30,000 BTU/H Wall Mounted Heat- Pump System

Job Name _____ Location _____ Date _____

Purchaser _____ Engineer _____

Submitted To _____ For Reference Approval Construction

Unit Designation _____ Schedule No. _____

- GENERAL FEATURES**
- Up to 4 Indoor Units (4-Port)
 - EnergyStar Rated
 - G10 DC Inverter Technology
 - Quiet Operation - Both Indoor & Outdoor
 - Acrylic Resin/Anti-Corrosion Coil Protection Inside & Out
 - Intelligent Defrost
 - Auto Restart on Power Outages
 - Mult-point Diagnostics
 - Limited 5 yr Parts Warranty



System Ratings

Outdoor Unit Data

Non-Ducted Indoor

Rated Cooling Capacity	28,400 BTUH
Cooling Capacity (min-max)	8,189-33,438 BTUH
Rated Heating Capacity	30,00 BTUH
Heating Capacity (min-max)	8,189-32,414 BTUH
SEER/EER	21.0/12.5
HSPF/COP	11.5/3.7

Compressor	Type	DC Inverter Driven Rotary
	RLA	13.9 A
Fan Motor	Output Power	100 W
	FLA	0.7 A
	Air Flow (Max)	2,354 CFM

Ducted Indoor

Rated Cooling Capacity	28,400 BTUH
Cooling Capacity (min-max)	6,200-30,800 BTUH
Rated Heating Capacity	30,000 BTUH
Heating Capacity (min-max)	6,500-32,500 BTUH
SEER/EER	16.0/10.5
HSPF/COP	8.5/3.3

Sound Pressure

Cooling	59 db(A)
Heating	59 db(A)

Dimensions & Weights

Unit Dimensions (LxHxD)	38.4 x 31.0 x 17.3 -in
Weight (Net/Shipping)	154.0/169.4 LBS

Min. Number of Indoor Units 2
Max. Number of Indoor Units 4

Operating Range

Cooling (min-max)	0 ~ 118°F -18 ~ 48°C
Heating (min-max)	-4 ~ 86°F -20 ~ 30°C

Refrigerant Piping Data

Refrigerant Type	R410A
Refrigerant Charge	98.7 oz
Additional Charge Per Line Length	0.21-oz/ft
Connection Method	Flared
Factory Charge for Total Line Length	131-ft
Total Refrigerant Pipe Length	230-ft
Max Refrigerant Piping Length to any Indoor Unit	82-ft
Min Refrigerant Piping Length to any Indoor Unit	10-ft
Max Elevation between Indoor Units	25-ft
Max Lift from Outdoor to Indoor Unit	49-ft
Max Drop from Outdoor to Indoor Unit	49-ft

Power Supply

Normal Operational Voltage	208/230 V, 1 Phase, 60 Hz
Voltage Range	187 - 253 V
Main Power Wire Size	10-2 AWG
Interconnecting Cable Wire Size	14-4 AWG
MCA	20.0 A
MOCP/Breaker Size	30 A

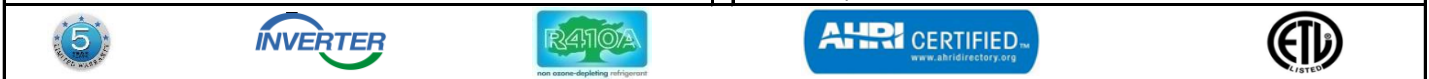

30,000 BTUH MODEL

Model # MULTI30HP230V1CO 30,000 BTUH 230V

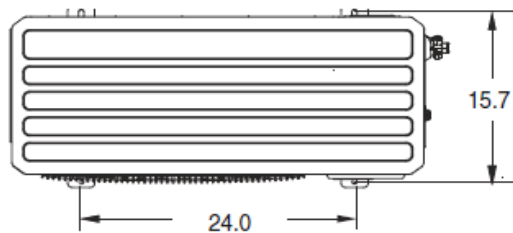
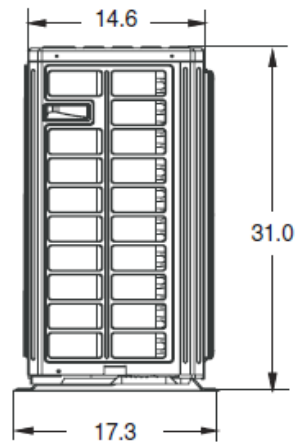
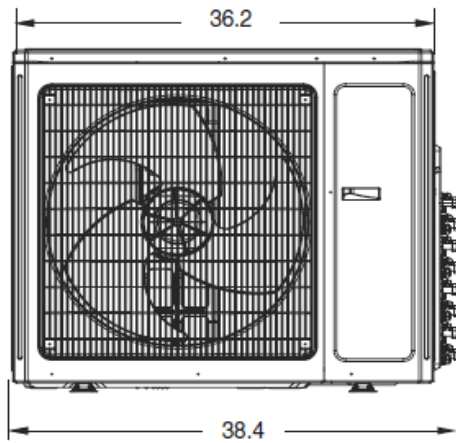

Suction/Gas Line Port Size

Port A	3/8-in OD Flared
Port B	3/8-in OD Flared
Port C	3/8-in OD Flared
Port D	3/8-in OD Flared

Factory Supplied Piping Adapters

Adapter	P/N	Qty
3/8 (F) to 5/8 (M)	6654100009	2
3/8 (F) to 1/2 (M)	6654100013	4
1/4 (F) to 3/8 (M)	6654104	2

Liquid Line Port Size

Port A	1/4-in OD Flared
Port B	1/4-in OD Flared
Port C	1/4-in OD Flared
Port D	1/4-in OD Flared

MINIMUM SPACING REQUIREMENTS

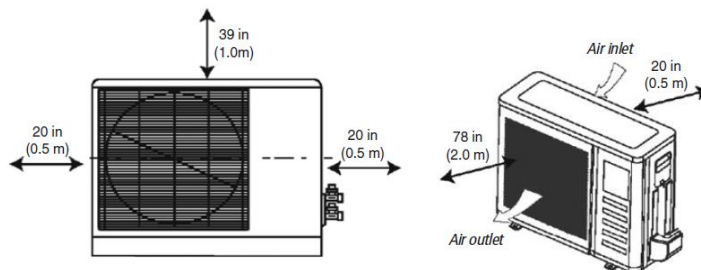

Notes:

1. Recommended Interconnecting Cable Type Stranded Copper Conductors THHN 600V Unshielded Wire
2. Power wiring cable size must comply with applicable national and local codes.
3. Test conditions are based on AHRI 210/240.

Specifications are subject to change without notice. Manufacturer reserves the right to discontinue or modify specifications or designs without notice or without incurring obligations. All rights reserved.



Units: inch

Model # LIVS09HP230V1xH 9,000 BTUH 230V

9,000 BTUH MODEL

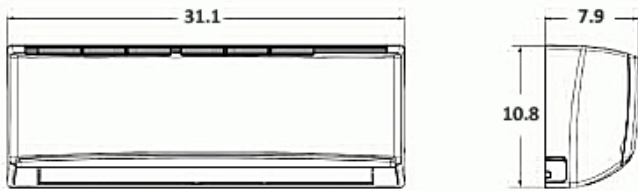

Liquid Line Valve	1/4-in OD Flared
Suction/Gas Line Valve	3/8-in OD Flared
Drain Connector	5/8-in OD

Rated Cooling (BtuH)	Rated Heating (BtuH)	Max. CFM	Dehum (Pt/Hr)	Min/Max Sound Power dB(A)**
9,000	9,500	318	1.7	28/43

Note: Size Refrigerant lines based on evaporator port sizes.

Model # LIVS12HP230V1xH 12,000 BTUH 230V

12,000 BTUH MODEL

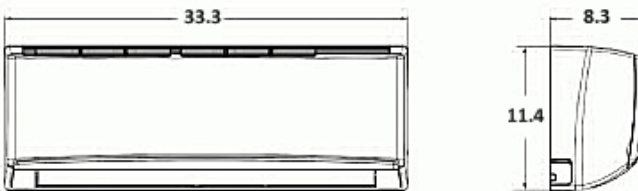

Liquid Line Valve	1/4-in OD Flared
Suction/Gas Line Valve	3/8-in OD Flared
Drain Connector	5/8-in OD

Rated Cooling (BtuH)	Rated Heating (BtuH)	Max. CFM	Dehum (Pt/Hr)	Min/Max Sound Power dB(A)**
12,000	13,000	400	3.0	29/45

Note: Size Refrigerant lines based on evaporator port sizes.

Model # LIVS18HP230V1xH 18,000 BTUH 230V

18,000 BTUH MODEL

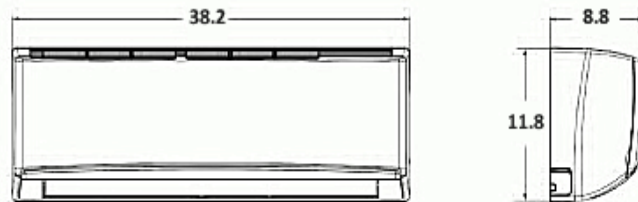

Liquid Line Valve	1/4-in OD Flared
Suction/Gas Line Valve	1/2-in OD Flared
Drain Connector	5/8-in OD

Rated Cooling (BtuH)	Rated Heating (BtuH)	Max. CFM	Dehum (Pt/Hr)	Min/Max Sound Power dB(A)**
18,000	19,000	471	3.8	35/46

Note: Size Refrigerant lines based on evaporator port sizes.

Model # LIVS24HP230V1xH 24,000 BTUH 230V

24,000 BTUH MODEL

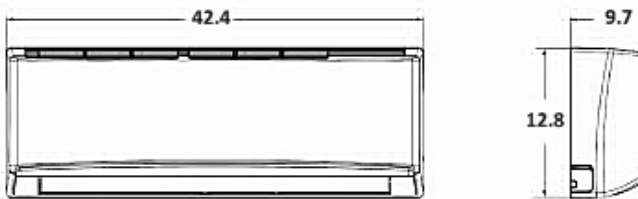

Liquid Line Valve	1/4-in OD Flared
Suction/Gas Line Valve	5/8-in OD Flared
Drain Connector	5/8-in OD

Rated Cooling (BtuH)	Rated Heating (BtuH)	Max. CFM	Dehum (Pt/Hr)	Min/Max Sound Power dB(A)**
22,000	23,000	706	5.3	36/48

Note: Size Refrigerant lines based on evaporator port sizes.

**Sound Power ratings are per AHRI 270 and AHRI 350

Specifications are subject to change without notice. Manufacturer reserves the right to discontinue or modify specifications or designs

without notice or without incurring obligations. All rights reserved.



Units: inch

9,000 AND 12,000 BTUH MODELS

Model # VIR09HP230V1xH 9,000 BTUH 230V
 Model # VIR12HP230V1xH 12,000 BTUH 230V

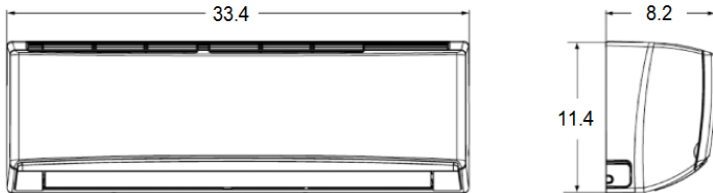

9,000 BTU	
Liquid Line Valve	1/4-in OD Flared
Suction/Gas Line Valve	3/8-in OD Flared
Drain Connector	5/8-in OD

12,000 BTU	
Liquid Line Valve	1/4-in OD Flared
Suction/Gas Line Valve	1/2-in OD Flared
Drain Connector	5/8-in OD

Note: Size Refrigerant lines based on evaporator port sizes.

Indoor Capacity Size	Rated Cooling	Rated Heating	Max. CFM	Dehum (Pt/Hr)	Min/Max Sound Power dB(A)**
9,000 BTUH	9,000	11,000	377	1.7	29/43
12,000 BTUH	12,000	13,000	400	3.0	29/45

18,000 BTUH MODEL

Model # VIR18HP230V1xH 18,000 BTUH 230V

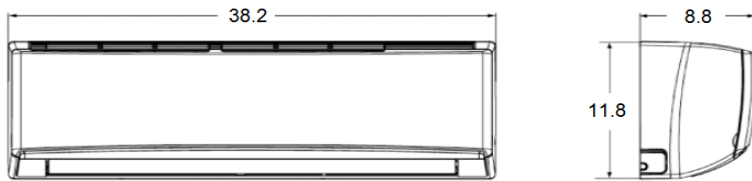

Liquid Line Valve	1/4-in OD Flared
Suction/Gas Line Valve	5/8-in OD Flared
Drain Connector	5/8-in OD

Note: Size Refrigerant lines based on evaporator port sizes.

Rated Cooling (BtuH)	Rated Heating	Max. CFM	Dehumid. (Pt/Hr)	Min/Max Sound Power dB(A)**
18,000	19,800	559	3.8	39/47

24,000 BTUH MODEL

Model # VIR24HP230V1xH 24,000 BTUH 230V

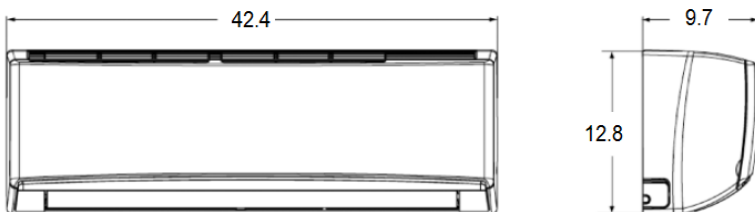

Liquid Line Valve	1/4-in OD Flared
Suction/Gas Line Valve	5/8-in OD Flared
Drain Connector	5/8-in OD

Note: Size Refrigerant lines based on evaporator port sizes.

Rated Cooling (BtuH)	Rated Heating	Max. CFM	Dehumid. (Pt/Hr)	Min/Max Sound Power dB(A)**
22,000	23,000	706	4.2	36/48

**Sound Power ratings are per AHRI 270 and AHRI 350

Specifications are subject to change without notice. Manufacturer reserves the right to discontinue or modify specifications or designs without notice or without incurring obligations. All rights reserved.

Units: inch (mm)

9,000 AND 12,000 BTUH MODELS



Model # TERRA09HP230V1AH 9,000 BTUH 230V

Model # TERRA12HP230V1AH 12,000 BTUH 230V

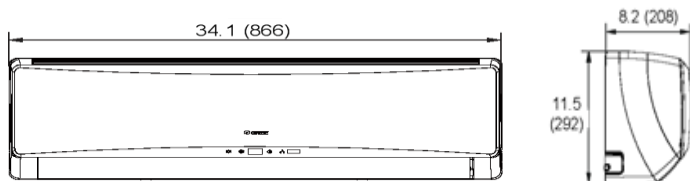

Liquid Line Valve	1/4-in OD Flared
Suction/Gas Line Valve	1/2-in OD Flared
Drain Connector	5/8-in OD

Note: Size Refrigerant lines based on evaporator port sizes.

Rated Cooling (BtuH)	Rated Heating	Max. CFM	Dehumid. (Pt/Hr)	Min/Max Sound Power dB(A)**
9,000	9,800	418	1.9	23/43
12,000	13,000	453	3	24/44

18,000 BTUH MODEL

Model # TERRA18HP230V1BH 18,000 BTUH 230V

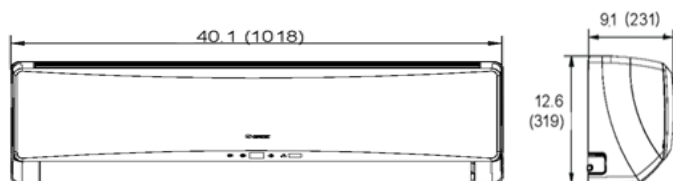

Liquid Line Valve	1/4-in OD Flared
Suction/Gas Line Valve	5/8-in OD Flared
Drain Connector	5/8-in OD

Note: Size Refrigerant lines based on evaporator port sizes.

Rated Cooling (BtuH)	Rated Heating	Max. CFM	Dehumid. (Pt/Hr)	Min/Max Sound Power dB(A)**
18,000	19,000	559	3.8	33/51

24,000 BTUH MODEL

Model # TERRA24HP230V1AH 24,000 BTUH 230V

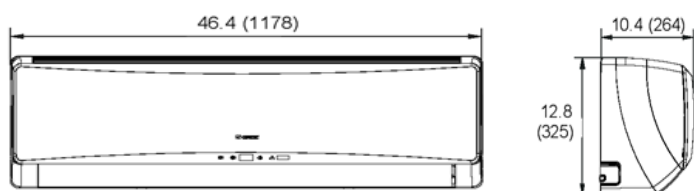

Liquid Line Valve	1/4-in OD Flared
Suction/Gas Line Valve	5/8-in OD Flared
Drain Connector	5/8-in OD

Note: Size Refrigerant lines based on evaporator port sizes.

Rated Cooling (BtuH)	Rated Heating	Max. CFM	Dehumid. (Pt/Hr)	Min/Max Sound Power dB(A)**
24,000	25,000	647	5.3	38/52

**Sound Power ratings are per AHRI 270 and AHRI 350

Specifications are subject to change without notice. Manufacturer reserves the right to discontinue or modify specifications or designs

without notice or without incurring obligations. All rights reserved.



Units: inch

9,000 BTUH MODELS

Model # CROWN09HP230V1xH 9,000 BTUH 230V

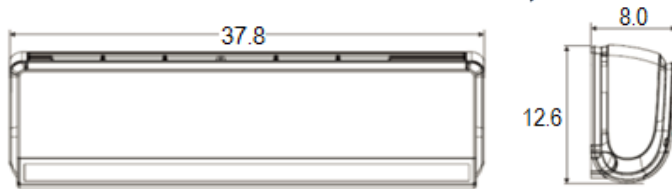

Liquid Line Valve	1/4-in OD Flared
Suction/Gas Line Valve	1/2-in OD Flared
Drain Connector	5/8-in OD

Note: Size Refrigerant lines based on evaporator port sizes.

Rated Cooling (BtuH)	Rated Heating	Max. CFM	Dehumid. (Pt/Hr)	Min/Max Sound Power dB(A)**
9,000	9,000	412	1.7	22/41

12,000 BTUH MODEL

Model # CROWN12HP230V1xH 12,000 BTUH 230V

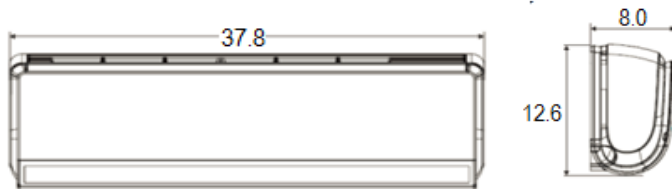

Liquid Line Valve	1/4-in OD Flared
Suction/Gas Line Valve	1/2-in OD Flared
Drain Connector	5/8-in OD

Note: Size Refrigerant lines based on evaporator port sizes.

Rated Cooling (BtuH)	Rated Heating	Max. CFM	Dehumid. (Pt/Hr)	Min/Max Sound Power dB(A)**
12,000	13,000	471	3.0	23/42

18,000 BTUH MODEL

Model # CROWN18HP230V1xH 18,000 BTUH 230V

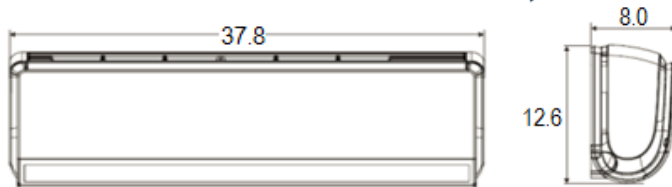

Liquid Line Valve	1/4-in OD Flared
Suction/Gas Line Valve	5/8-in OD Flared
Drain Connector	5/8-in OD

Note: Size Refrigerant lines based on evaporator port sizes.

Rated Cooling (BtuH)	Rated Heating	Max. CFM	Dehumid. (Pt/Hr)	Min/Max Sound Power dB(A)**
18,000	19,000	530	3.8	26/48

**Sound Power ratings are per AHRI 270 and AHRI 350

Specifications are subject to change without notice. Manufacturer reserves the right to discontinue or modify specifications or designs without notice or without incurring obligations. All rights reserved.

COOLING CAPACITY (BTUH)

Indoor Units Combinations	Rated System Capacity (BtuH)	Indoor Unit A (BtuH)	Indoor Unit B (BtuH)	Indoor Unit C (BtuH)	Indoor Unit D (BtuH)
9+9	18,000	9,000	9,000	NA	NA
9+12	21,000	9,000	12,000	NA	NA
9+18	22,950	7,650	15,300	NA	NA
9+24	27,780	7,380	20,400	NA	NA
12+12	24,000	12,000	12,000	NA	NA
12+18	25,500	10,200	15,300	NA	NA
12+24	28,860	9,420	19,440	NA	NA
18+18	28,360	14,180	14,180	NA	NA
18+24	29,100	12,000	17,100	NA	NA
9+9+9	25,500	8,500	8,500	8,500	NA
9+9+12	26,200	8,000	8,000	10,200	NA
9+9+18	29,800	7,650	7,650	14,500	NA
9+9+24	29,800	6,300	6,300	17,200	NA
9+12+12	28,200	8,200	10,000	10,000	NA
9+12+18	29,600	7,000	8,600	14,000	NA
12+12+12	28,500	9,500	9,500	9,500	NA
12+12+18	30,200	8,600	8,600	13,000	NA
9K + 9K + 9K + 9K	29,600	7,400	7,400	7,400	7,400
9K + 9K + 9K + 12K	29,700	7,100	7,100	7,100	8,400
9K + 9K + 12K + 12K	29,600	6,800	6,800	8,000	8,000

HEATING CAPACITY (BTUH)

Indoor Units Combinations	Rated System Capacity (BtuH)	Indoor Unit A (BtuH)	Indoor Unit B (BtuH)	Indoor Unit C (BtuH)	Indoor Unit D (BtuH)
9+9	19,000	9,500	9,500	NA	NA
9+12	22,500	9,500	13,000	NA	NA
9+18	25,380	8,460	16,920	NA	NA
9+24	30,840	8,280	22,560	NA	NA
12+12	26,000	13,000	13,000	NA	NA
12+18	28,200	11,280	16,920	NA	NA
12+24	29,900	9,900	20,000	NA	NA
18+18	30,200	15,100	15,100	NA	NA
18+24	31,800	13,300	18,500	NA	NA
9+9+9	28,500	9,500	9,500	9,500	NA
9+9+12	28,800	8,800	8,800	11,200	NA
9+9+18	31,100	7,900	7,900	15,300	NA
9+9+24	31,500	6,750	6,750	18,000	NA
9+12+12	28,900	8,500	10,200	10,200	NA
9+12+18	30,700	7,200	9,000	14,500	NA
12+12+12	29,700	9,900	9,900	9,900	NA
12+12+18	31,500	9,000	9,000	13,500	NA
9K + 9K + 9K + 9K	30,800	7,700	7,700	7,700	7,700
9K + 9K + 9K + 12K	31,300	7,300	7,300	7,300	9,400
9K + 9K + 12K + 12K	31,600	6,800	6,800	9,000	9,000

Capacity data is based on the following conditions :

Cooling Nominal Test Conditions

Indoor: 80°F DB/67°F WB

Outdoor: 95°F DB/75°F WB

Specifications are subject to change without notice. Manufacturer reserves the right to discontinue or modify specifications or designs without notice or without incurring obligations. All rights reserved.

COOLING PERFORMANCE

		Indoor Ambient Temperature											
		70°F (21°C)			75°F (24°C)			80°F (27°C)			90°F (32°C)		
		59°F (15°C)			63°F (17°C)			67°F (19°C)			73°F (23°C)		
DB	WB	TC	SC	Input Power	TC	SC	Input Power	TC	SC	Input Power	TC	SC	Input Power
		(BtuH)	(BtuH)	(watts)	(BtuH)	(BtuH)	(watts)	(BtuH)	(BtuH)	(watts)	(BtuH)	(BtuH)	(watts)
Outdoor Ambient Temperature (DB)	-0.4°F (-18°C)	17,230	13,510	1,050	19,430	15,240	1,110	20,540	16,110	1,150	23,150	18,150	1,230
	5°F (-15°C)	17,670	13,860	1,050	19,930	15,630	1,120	21,320	16,720	1,150	23,730	18,620	1,230
	14°F (-10°C)	18,500	14,510	1,060	20,870	16,370	1,120	22,060	17,300	1,160	24,860	19,490	1,240
	23°F (-5°C)	20,270	15,900	1,060	23,090	18,110	1,120	24,840	19,490	1,150	27,330	21,430	1,230
	32°F (0°C)	20,368	17,612	1,430	23,281	19,840	1,430	25,621	21,538	1,699	26,748	25,005	1,612
	41°F (5°C)	21,413	18,515	1,503	24,474	20,857	1,503	26,935	22,643	1,786	28,119	26,288	1,695
	50°F (10°C)	22,305	19,287	1,566	25,494	21,726	1,566	28,057	23,586	1,860	29,291	27,383	1,765
	59°F (15°C)	23,500	20,320	1,650	26,860	22,890	1,650	29,560	24,850	1,960	30,860	28,850	1,860
	68°F (20°C)	24,520	21,135	1,736	27,550	23,714	1,760	30,313	25,704	2,009	31,228	29,201	2,025
	77°F (25°C)	28,631	23,264	2,108	31,071	25,502	2,111	33,852	27,389	2,365	37,373	28,573	2,402
	86°F (30°C)	30,859	24,172	2,826	33,084	26,134	2,853	35,179	32,712	2,905	39,601	29,290	2,955
	95°F (35°C)	28,914	23,131	3,099	31,218	25,298	3,121	33,654	26,154	3,206	37,012	28,522	3,267
	104°F (40°C)	22,851	20,906	2,566	24,550	22,872	2,583	26,052	24,462	2,773	28,321	25,171	2,668
113°F (45°C)	17,839	17,658	2,172	19,214	19,057	2,207	25,738	25,110	2,835	21,800	21,387	2,244	
118°F (48°C)	13,700	13,628	1,708	15,030	14,908	1,762	16,634	16,382	1,896	17,770	17,433	1,867	

HEATING PERFORMANCE

		Indoor Ambient Temperature											
		70°F (21°C)			75°F (24°C)			80°F (27°C)			90°F (32°C)		
		59°F (15°C)			63°F (17°C)			67°F (19°C)			73°F (23°C)		
DB	WB	TC	SC	Input Power	TC	SC	Input Power	TC	SC	Input Power	TC	SC	Input Power
		(BtuH)	(BtuH)	(watts)	(BtuH)	(BtuH)	(watts)	(BtuH)	(BtuH)	(watts)	(BtuH)	(BtuH)	(watts)
Outdoor Ambient Temperature (DB)	-4°F (-20°C)	17,060	17,060	1,500	16,580	16,580	1,530	16,260	16,260	1,580	15,850	15,850	1,620
	0°F (-18°C)	18,500	18,500	1,650	17,960	17,960	1,680	17,630	17,630	1,740	17,160	17,160	1,780
	5°F (-15°C)	19,510	19,510	1,720	18,950	18,950	1,750	18,590	18,590	1,820	18,110	18,110	1,860
	7°F (-14°C)	20,010	20,010	1,750	19,050	19,050	1,790	19,360	19,360	1,870	18,860	18,860	1,920
	17°F (-8°C)	20,940	20,940	1,790	20,330	20,330	1,830	19,950	19,950	1,900	19,420	19,420	1,940
	28°F (-2°C)	23,660	23,660	1,910	23,040	23,040	1,950	22,380	22,380	2,020	22,110	22,110	2,070
	38°F (3°C)	29,420	29,420	2,200	28,800	28,800	2,240	28,140	28,140	2,330	27,870	27,870	2,380
	47°F (8°C)	33,250	33,250	2,290	32,240	32,240	2,330	31,600	31,600	2,420	30,730	30,730	2,480
	57°F (14°C)	34,350	34,350	2,330	33,310	33,310	2,380	32,650	32,650	2,470	31,740	31,740	2,520
	68°F (20°C)	35,750	35,750	2,410	34,660	34,660	2,460	33,970	33,970	2,550	33,030	33,030	2,610
	77°F (25°C)	36,580	36,580	2,470	35,470	35,470	2,520	34,760	34,760	2,620	33,800	33,800	2,680

LEGEND

DB --- Dry Bulb TC --- Total Net Cooling Capacity (BtuH) Input Power---(Watts)
 WB --- Wet Bulb SC --- Sensible Capacity (BtuH)

Specifications are subject to change without notice. Manufacturer reserves the right to discontinue or modify specifications or designs without notice or without incurring obligations. All rights reserved.