

AUU9RLF - CABINETRY ASSY

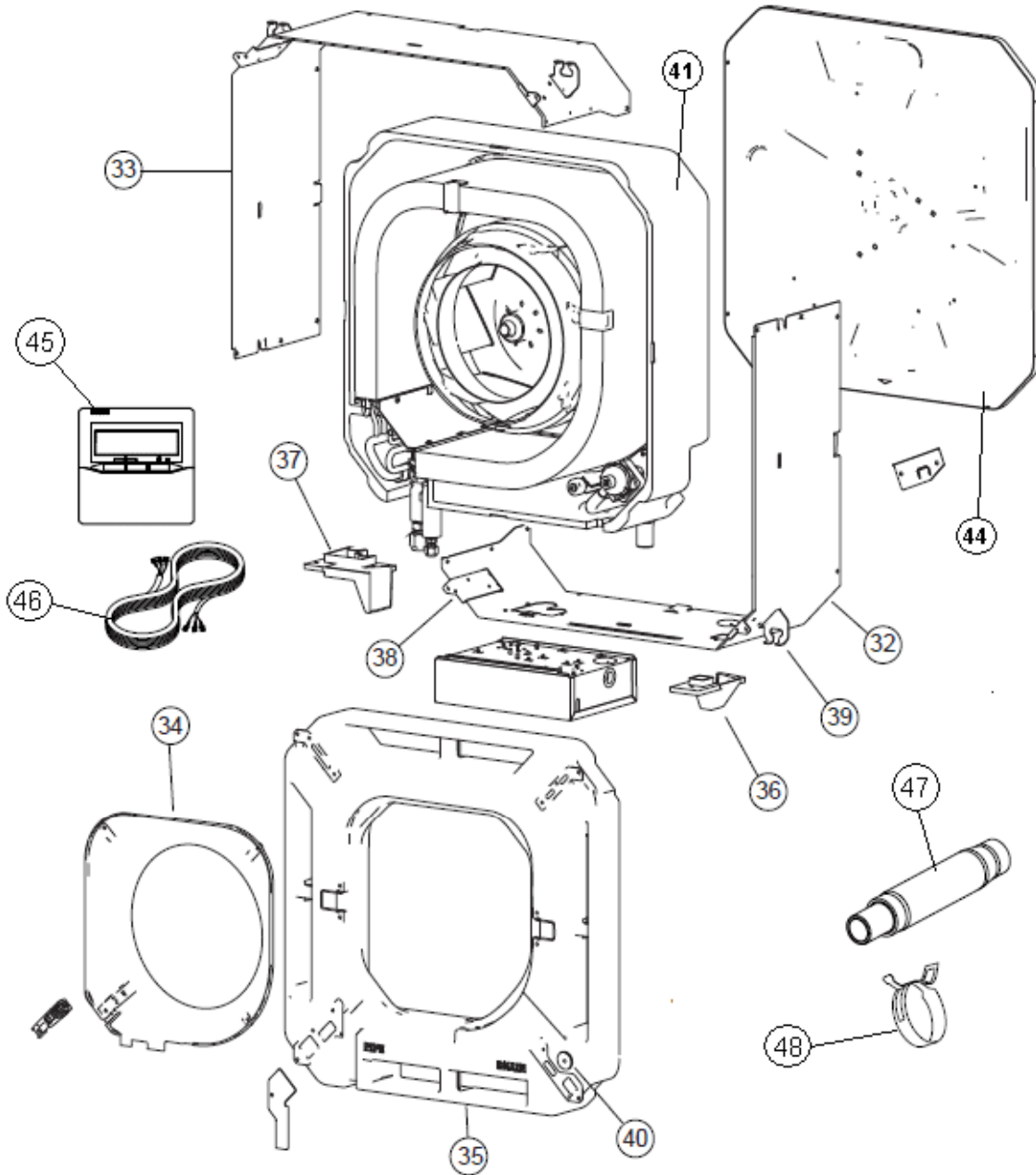

Bubble #	Part #	Description
32	K9375492014	CABINET A ASSY PACC HFI
33	K9375494018	CABINET B PACC HFI
34	K9375503017	BELL MOUTH 410i PACC HIPS BLACK
35	K9377765024	DRAIN PAN SUB ASSY AUU**RML STYROFOAM RA73
36	K9375516017	WIRE COVER PACC HFI
37	K9375515027	PIPE COVER PACC HFI# TC74 HIPS PLASTIC GRAY
38	K9375504014	HOOK R AUU**HFI# METAL SGCC Z-CF-XZ22 T1.6
39	K9375505011	HOOK L 410i AUU**# SGCCZ-CF-X- Z22 T1.6
40	K9375502010	DRAIN CAP PACC HFI

41	K9377764065	INSULATION BOX AUU**# STYROFOAM
44	K9375490027	TOP PLATE METAL
45	K9318593006	REMOTE CONTROL A*UHFI AR-WAE1U
46	K9372714010	REMOTE WIRE 410 AUU** UL1015 3P AWG22 L=30'
47	K9379665032	HOSE DRAIN AUU**HFI ID25-OD26L233
48	K9379757010	BAND HOSE AU*HFI#

AUU9RLF - ELECTRICAL ASSY

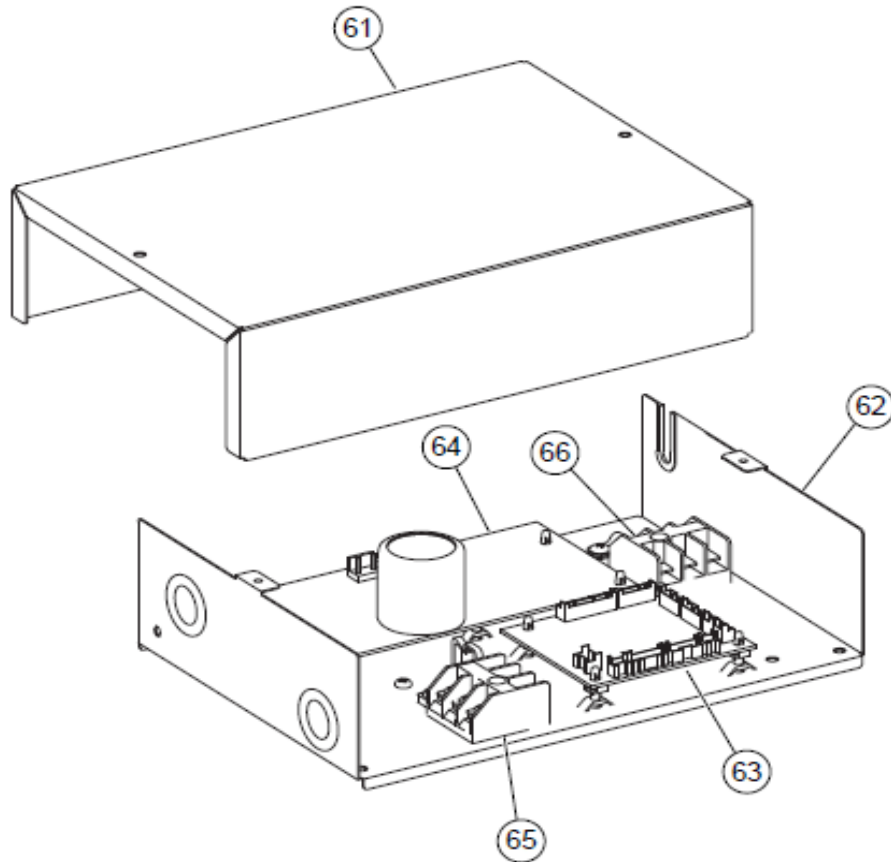

Bubble #	Part #	Description
61	K9375512019	CONTROL BOX COVER AUU**# METAL
62	K9379250016	CONTROL BOX A AUU**HFI# TC74 METAL
63	K9707393668	CONTROLLER PCB AUU9RLF# K06AK-1000HSE-C1
64	K9707398236	POWER FILTER PCB AU*HFI# K06AL-1005HSE-P0
65	K9306489045	TERMINAL 3P AUU**RML# HP-T3031-3-L1
66	K9703345012	TERMINAL 3P WIRED REMOTE AUU*# HP-T3031-21
A	K9703297014	THERMISTOR PIPE AUU**410 KTM-45-FG1-3 Replaces: K9701947027
B	K9900502003	THERMISTOR ROOM AUU**RML KTEC-41-F30-1
C	K9318593006	REMOTE CONTROL A*UHFI AR-WAE1U
D	K0600378141	FUSE PACC RLF 3.15V 250V 8H17 (EM) FTC Replaces: K0600422011,K0600466015

AUU9RLF - EVAPORATOR PUMP ASSY

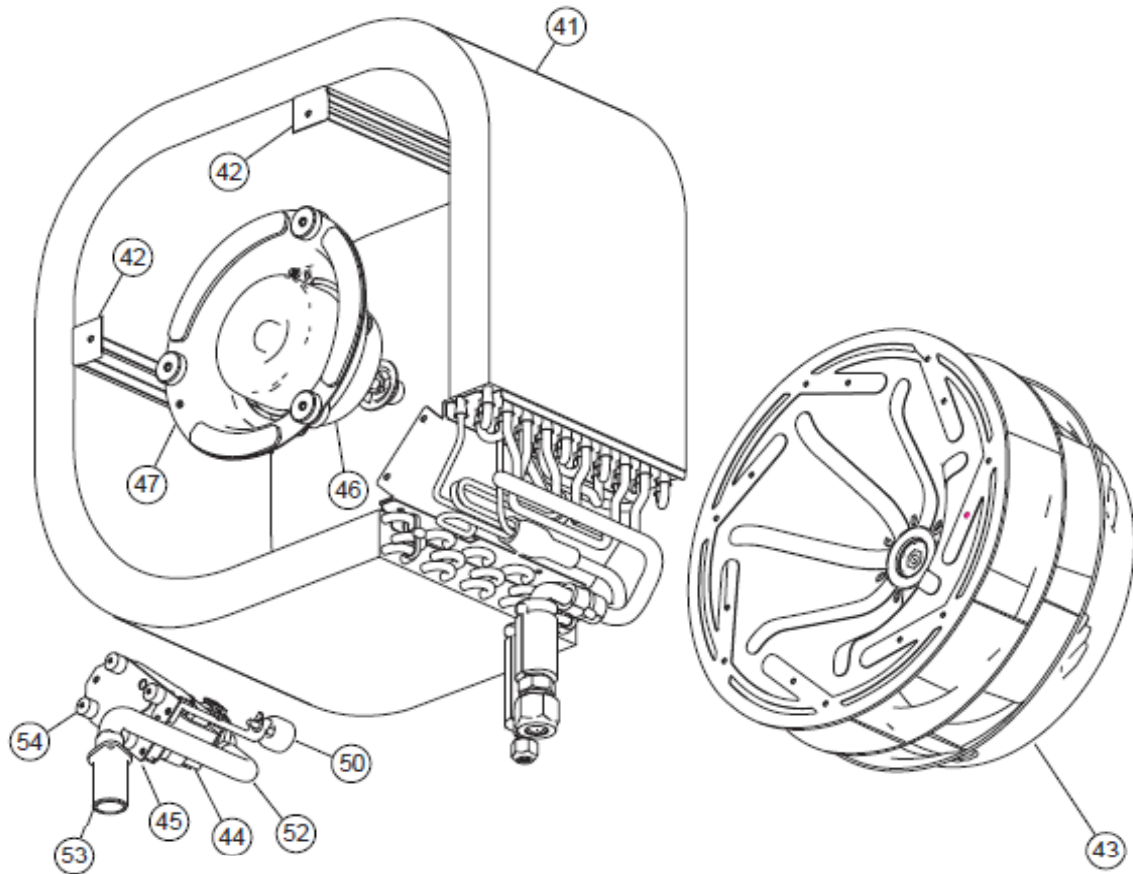

Bubble #	Part #	Description
41	K9377914033	EVAPORATOR TA ASSY AU9/12RLF RA71
42	K9375508012	HOLDER EVAPORATOR AUU**RML HFI SGCCZ-CF-X Z22 T1.0
43	K9375480011	FAN 2 STAGE TURBO 410i PACC ASG D320 BLACK
44	K9900472030	PUMP ASSY AU*HFI PLD-12230KG-6
45	K9375518011	DRAIN PUMP HOLDER B PACC HFI SGCC Z-CF-X T1.2
46	K9602870004	MOTOR FAN BRUSHLESS 410i PACC# MFF-24VVL FGLS
47	K9375552015	FAN MOTOR HOLDER 410i PACC SGCC-Z-CF-XZ22 T1.2
50	K9900361037	FLOAT SWITCH AUU**# YKG(R)-6KG-5
52	K9375519018	DRAIN HOSE PACC HFI FROM PUMP
53	K9375520014	DRAIN PORT PACC HFI#
54	K9378426016	RUBBER (PUMP)