

AIR CONDITIONER

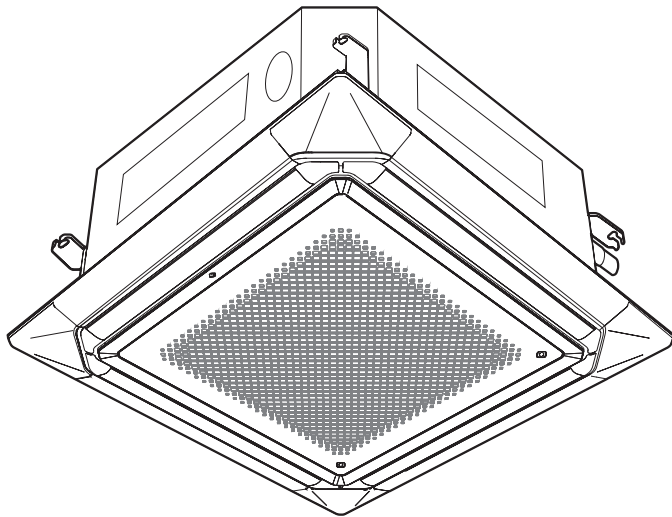

INSTALLATION MANUAL

INDOOR UNIT (Cassette type)
For authorized service personnel only.

English

MANUEL D'INSTALLATION

UNITÉ INTÉRIEURE (Type cassette)
Pour le personnel de service agréé uniquement.

Français

MANUAL DE INSTALACIÓN

UNIDAD INTERIOR (Tipo cassette)
Únicamente para personal de servicio autorizado.

Español



PART No. 9381798056

INSTALLATION MANUAL

PART No. 9381798056

INDOOR UNIT (Cassette type)

Contents

1. SAFETY PRECAUTIONS	1
1.1. IMPORTANT! Please read before starting	1
1.2. SPECIAL PRECAUTIONS	1
2. ABOUT THIS PRODUCT	2
2.1. Precautions for using R410A refrigerant	2
2.2. Special tools for R410A	2
2.3. Accessories	2
2.4. Optional parts	2
3. GENERAL SPECIFICATION	3
3.1. Selecting the pipe material	3
3.2. Pipe requirement	3
3.3. Electrical requirement	3
4. INSTALLATION WORK	3
4.1. Selecting an installation location	3
4.2. Installation dimension	4
4.3. Installing the unit	4
4.4. Installing the drain pipe	5
5. PIPE INSTALLATION	6
5.1. Flare connection (pipe connection)	6
5.2. Installing heat insulation	7
6. ELECTRICAL WIRING	7
6.1. Wiring method	7
6.2. Connection wiring	8
7. CASSETTE GRILLE INSTALLATION	8
8. REMOTE CONTROLLER INSTALLATION	8
9. FUNCTION SETTING	9
9.1. Turning on the power	9
9.2. Setting method	9
9.3. RC Sensor setting	9
9.4. Function Details	9
10. SPECIAL INSTALLATION METHODS	11
10.1. Setting the address	11
10.2. Setting the DIP switch	11
10.3. Group control	11
10.4. Multiple remote control	11
11. OPTION AND OTHER CONNECTABLE DEVICES	12
11.1. Optional parts	12
11.2. External input and output	12
12. CHECK LIST	13
13. TEST RUN	13
14. CUSTOMER GUIDANCE	13
15. ERROR CODES	13

Note: This manual describes how to install the air conditioner described above. Handling and installation shall only be done by professionals as outlined in this manual.

- Installation must be performed in accordance with the requirement of NEC (National Electrical Code) and CEC (Canadian Electrical Code) by authorized personnel only.
- All products are manufactured to metric units and tolerances. United States customary units are provided for reference only. In cases where exact dimensions and tolerances are required, always refer to metric units.

1. SAFETY PRECAUTIONS

1.1. IMPORTANT! Please read before starting

This air conditioning system meets strict safety and operating standards. As the installer or service person, it is an important part of your job to install or service the system so it operates safely and efficiently.

For safe installation and trouble-free operation, you must:

- Carefully read this instruction booklet before beginning.
- Follow each installation or repair step exactly as shown.
- Observe all local, state, and national electrical codes.
- Pay close attention to all danger, warning, and caution notices given in this manual.

WARNING: This symbol refers to a hazard or unsafe practice which can result in severe personal injury or death.

CAUTION: This symbol refers to a hazard or unsafe practice which can result in personal injury and the potential for product or property damage.

- Hazard alerting symbols



: Electrical



: Safety/alert

If Necessary, Get Help

These instructions are all you need for most installation sites and maintenance conditions. If you require help for a special problem, contact our sales/service outlet or your certified dealer for additional instructions.

In Case of Improper Installation

The manufacturer shall in no way be responsible for improper installation or maintenance service, including failure to follow the instructions in this document.

1.2. SPECIAL PRECAUTIONS

When Wiring

ELECTRICAL SHOCK CAN CAUSE SEVERE PERSONAL INJURY OR DEATH. ONLY A QUALIFIED, EXPERIENCED ELECTRICIAN SHOULD ATTEMPT TO WIRE THIS SYSTEM.

- Do not supply power to the unit until all wiring and tubing are completed or reconnected and checked.
- Highly dangerous electrical voltages are used in this system. Carefully refer to the wiring diagram and these instructions when wiring. Improper connections and inadequate earthing (grounding) can cause accidental injury or death.
- Earth (Ground) the unit following local electrical codes.
- Connect all wiring tightly. Loose wiring may cause overheating at connection points and a possible fire hazard.

When Transporting

Be careful when picking up and moving the indoor and outdoor units. Get a partner to help, and bend your knees when lifting to reduce strain on your back. Sharp edges or thin aluminum fins on the air conditioner can cut your fingers.

When Installing...

...In a Ceiling or Wall

Make sure the ceiling/wall is strong enough to hold the unit's weight. It may be necessary to construct a strong wood or metal frame to provide added support.

...In a Room

Properly insulate any tubing run inside a room to prevent "sweating" that can cause dripping and water damage to walls and floors.

...In an Area with High Winds

Securely anchor the outdoor unit down with bolts and a metal frame. Provide a suitable air baffle.

...In a Snowy Area (for Heat Pump-type Systems)

Install the outdoor unit on a raised platform that is higher than drifting snow.

When Connecting Refrigerant Tubing

- Keep all tubing runs as short as possible.
- Use the flare method for connecting tubing.
- Apply refrigerant lubricant to the matching surfaces of the flare and union tubes before connecting them, then tighten the nut with a torque wrench for a leak-free connection.
- Check carefully for leaks before opening the refrigerant valves.

When Servicing

- Turn the power OFF at the main circuit breaker panel before opening the unit to check or repair electrical parts and wiring.
- Keep your fingers and clothing away from any moving parts.
- Clean up the site after you finish, remembering to check that no metal scraps or bits of wiring have been left inside the unit being serviced.
- After installation, explain correct operation to the customer, using the operating manual.

WARNING

Never touch electrical components immediately after the power supply has been turned off. Electrical shock may occur. After turning off the power, always wait 10 minutes or more before touching electrical components.

- Be sure to read this manual thoroughly before installation.
- The warnings and precautions indicated in this Manual contain important information pertaining to your safety. Be sure to observe them.
- Hand this Manual, together with the operating manual, to the customer. Request the customer to keep them on hand for future use, such as for relocating or repairing the unit.

WARNING

- Installation of this product must be done by experienced service technicians or professional installers only in accordance with this manual. Installation by nonprofessional or improper installation of the product may cause serious accidents such as injury, water leakage, electric shock, or fire. If the product is installed in disregard of the instructions in this manual, it will void the manufacturer's warranty.
- Do not turn on the power until all work has been completed. Turning on the power before the work is completed can cause serious accidents such as electric shock or fire.
- If refrigerant leaks when you are working, ventilate the area. If the leaking refrigerant is exposed to a direct flame it may produce a toxic gas.
- Do not use this equipment with air or any other unspecified refrigerant in the refrigerant lines. Excess pressure can cause a rupture.
- Installation must be performed in accordance with regulations, codes, or standards for electrical wiring and equipment in each country, region, or the installation place.
- This appliance is not intended for use by persons (including children) with reduced physical, sensory or mental capabilities, or lack of experience and knowledge, unless they have been given supervision or instruction concerning use of the appliance by a person responsible for their safety. Children should be supervised to ensure that they do not play with the appliance.

⚠ CAUTION

- Read carefully all safety information written in this manual before you install or use the air conditioner.
- Install the product by following local codes and regulations in force at the place of installation, and the instructions provided by the manufacturer.
- This product is part of a set constituting an air conditioner. The product must not be installed alone or be installed with non-authorized device by the manufacturer.
- Always use a separate power supply line protected by a circuit breaker operating on all wires with a distance between contact of 1/8 in (3 mm) for this product.
- To protect the persons, earth (ground) the product correctly, and use the power cable combined with an Earth Leakage Circuit Breaker (ELCB).
- This product is not explosion proof, and therefore should not be installed in explosive atmosphere.
- Do not touch the fins of the heat exchanger. Touching the heat exchanger fins could result in damage to the fins or personal injury such as skin rupture.
- This product contains no user-serviceable parts. Always consult experienced service technicians for repairing.
- When moving or relocating the air conditioner, consult experienced service technicians for disconnection and reinstallation of the product.
- Do not place any other electrical products or household belongings under the product. Condensation dripping from the product might get them wet, and may cause damage or malfunction to the property.

2. ABOUT THIS PRODUCT

2.1. Precautions for using R410A refrigerant

- The basic installation work procedures are the same as conventional refrigerant (R22) models. However, pay careful attention to the following points:
- Since the working pressure is 1.6 times higher than that of conventional refrigerant (R22) models, some of the piping and installation and service tools are special. (Refer to the following table.) Especially, when replacing a conventional refrigerant (R22) model with a new refrigerant R410A model, always replace the conventional piping and flare nuts with the R410A piping and flare nuts.
- Models that use refrigerant R410A have a different charging port thread diameter to prevent erroneous charging with conventional refrigerant (R22) and for safety. Therefore, check beforehand. [The charging port thread diameter for R410A is 1/2-20 UNF.]
- Be more careful that foreign matter (oil, water, etc.) does not enter the piping than with refrigerant (R22) models. Also, when storing the piping, securely seal the opening by pinching, taping, etc.
- When charging the refrigerant, take into account the slight change in the composition of the gas and liquid phases. And always charge from the liquid phase where refrigerant composition is stable.

2.2. Special tools for R410A

Tool name	Contents of change
Gauge manifold	Pressure is high and cannot be measured with a R22 gauge. To prevent erroneous mixing of other refrigerants, the diameter of each port has been changed. It is recommended to use gauge with seals -30 inHg to 768 psi (-0.1 to 5.3 MPa) for high pressure. -30 inHg to 551 psi (-0.1 to 3.8 MPa) for low pressure.
Charge hose	To increase pressure resistance, the hose material and base size were changed.
Vacuum pump	A conventional vacuum pump can be used by installing a vacuum pump adapter.
Gas leakage detector	Special gas leakage detector for HFC refrigerant R410A.

Copper pipes

It is necessary to use seamless copper pipes and it is desirable that the amount of residual oil is less than 0.004 oz/100 ft (40 mg/10 m). Do not use copper pipes having a collapsed, deformed or discolored portion (especially on the interior surface). Otherwise, the expansion valve or capillary tube may become blocked with contaminants. As an air conditioner using R410A incurs pressure higher than when using R22, it is necessary to choose adequate materials.

⚠ WARNING

- Do not use the existing (for R22) piping and flare nuts. If the existing materials are used, the pressure inside the refrigerant cycle will rise and cause failure, injury, etc. (Use the special R410A materials.)
- Use (refill or replace with) specified refrigerant (R410A) only. Use of unspecified refrigerant can cause product malfunction, burst, or injury.
- Do not mix any gas or impurities except specified refrigerant (R410A). Inflow of air or application of unspecified material makes the internal pressure of the refrigerant cycle too high, and may cause product malfunction, burst of piping, or injury.











2.3. Accessories

⚠ WARNING

For installation purposes, be sure to use the parts supplied by the manufacturer or other prescribed parts. The use of non-prescribed parts can cause serious accidents such as the unit falling, water leakage, electric shock, or fire.

- The following installation parts are furnished. Use them as required.
- Keep the installation manual in a safe place and do not discard any other accessories until the installation work has been completed.

The following installation accessories are supplied. Use them as required.

Name and Shape	Q'ty	Application
Installation manual 	1	(This book)
Cable tie (large) 	4	For connection pipe fixing.
Cable tie (small) 	2	Only one is used for this model.
Coupler heat insulation (large) 	1	For indoor side pipe joint (gas pipe)
Coupler heat insulation (small) 	1	For indoor side pipe joint (liquid pipe)
Template (Carton top) 	1	For installing indoor unit
Washer 	8	For installing indoor unit
Insulation 	1	For installing drain pipe
Drain hose 	1	For installing drain pipe (Ø 3/4 in [I.D.], Ø 1-1/16 in [O.D.])
Hose Band 	1	For installing drain hose
Drain hose heat insulation 	1	For installing drain pipe

2.4. Optional parts

Parts name	Model No.	Summary
Wired Remote Controller	UTY-RNRUZ2	For air conditioner operation (2-wire type)
Simple Remote Controller	UTY-RSRY UTY-RHRY	For air conditioner operation (2-wire type)
IR receiver unit	UTY-LBTUC	For air conditioner operation
Human sensor	UTY-SHZXC	To prevent waste of electricity, this function controls the temperature setting when no one is occupying the room.
Wide panel	UTG-AKXA-W	Wide panel hides the gap between the ceiling hole and the Cassette grille.
Panel spacer	UTG-BKXA-W	Installation in a space of 2-3/16 in (56 mm) or greater is possible by using panel spacer when the height behind the ceiling is low.
Air outlet shutter plate	UTR-YDZK	Install the plate at outlet when carrying out 3-way direction operation
Insulation kit for High humidity	UTZ-KXRA	Install when the condition under the roof is over 80% in humidity and over 86°F (30°C) in temperature.
External input and output PCB	UTY-XCSX	For connecting external devices
External input and output PCB box	UTZ-GXRA	For installing the External input and output PCB
External connect kit	UTY-XWZXZG	For control output port

3. GENERAL SPECIFICATION

3.1. Selecting the pipe material

⚠ CAUTION

- Do not use existing pipes from another refrigeration system or refrigerant.
- Use pipes that have clean external and internal sides without any contamination which may cause trouble during use, such as sulfur, oxide, dust, cutting waste, oil, or water.
- It is necessary to use seamless copper pipes.
Material : Phosphor deoxidized seamless copper pipes
It is desirable that the amount of residual oil is less than 0.04 oz/100 ft (40 mg/10 m).
- Do not use copper pipes that have a collapsed, deformed, or discolored portion (especially on the interior surface). Otherwise, the expansion valve or capillary tube may become blocked with contaminants.
- Improper pipe selection will degrade performance. As an air conditioner using R410A incurs pressure higher than when using conventional (R22) refrigerant, it is necessary to choose adequate materials.

- Thicknesses of copper pipes used with R410A are as shown in the table.
- Never use copper pipes thinner than those indicated in the table even if they are available on the market.

Thicknesses of Annealed Copper Pipes (R410A)

Pipe outside diameter [in (mm)]	Thickness [in (mm)]
1/4 (6.35)	0.032 (0.80)
3/8 (9.52)	0.032 (0.80)
1/2 (12.70)	0.032 (0.80)
5/8 (15.88)	0.039 (1.00)
3/4 (19.05)	0.039 (1.20)

3.2. Pipe requirement

⚠ CAUTION

Refer to the installation manual of the outdoor unit for description of the length of connecting pipe or for difference of its elevation.

Model	Diameter [in (mm)]	
	Liquid	Gas
18	1/4 (6.35)	1/2 (12.70)
24/30/36/42	3/8 (9.52)	5/8 (15.88)

- Use pipe with water-resistant heat insulation.

⚠ CAUTION

Install heat insulation around both the gas and liquid pipes. Failure to do so may cause water leaks.
Use heat insulation with heat resistance above 248 °F (120 °C). (Reverse cycle model only)
In addition, if the humidity level at the installation location of the refrigerant piping is expected to exceed 70 %, install heat insulation around the refrigerant piping. If the expected humidity level is 70 to 80 %, use heat insulation that is 9/16 in (15 mm) or thicker and if the expected humidity exceeds 80 %, use heat insulation that is 13/16 in (20 mm) or thicker. If heat insulation is used that is not as thick as specified, condensation may form on the surface of the insulation. In addition, use heat insulation with heat conductivity of 0.045 W/(m·K) or less (at 68 °F (20 °C)).

3.3. Electrical requirement

The indoor unit is powered from the outdoor unit. Do not power indoor unit from separate power source.

⚠ WARNING

Standard for electrical wiring and equipment differs in each country or region. Before you start electrical working, confirm related regulations, codes, or standards.

Cable	Conductor size (AWG)	Cable type	Remarks
Connection cable	AWG 22 to 16	Sheathed PVC cable	3 wire + Earth (Ground)
Remote controller cable (2-wire type)	AWG 22 to 16	Sheathed PVC cable	Non-polar 2 wire, twisted pair

Cable Length: Limit voltage drop to less than 2%. Increase cable gauge if voltage drop is 2% or more.

4. INSTALLATION WORK

⚠ WARNING

- Do not turn on the power until all installation work is complete.
- Carrying and installation of the unit should be performed by a sufficient number of people and with sufficient equipment that is adequate for the weight of the unit. Performing such work with an insufficient number of people or with inadequate equipment could result in dropping of the unit or personal injury.

⚠ CAUTION

For installation details, refer to the technical data.

4.1. Selecting an installation location

Decide the mounting position together with the customer as follows.

⚠ WARNING

- Select installation locations that can properly support the weight of the indoor unit and which will not amplify sound or vibration. If the installation location is not strong enough, the indoor unit may fall and cause injuries.
- Install the units securely so that they do not topple or fall.

⚠ CAUTION

- Do not install the indoor unit in the following areas:
 - Area with high salt content, such as at the seaside.
It will deteriorate metal parts, causing the parts to fall or the unit to leak water.
 - Area filled with mineral oil or containing a large amount of splashed oil or steam, such as a kitchen.
It will deteriorate plastic parts, causing the parts to fall or the unit to leak water.
 - Area that generates substances that adversely affect the equipment, such as sulfuric gas, chlorine gas, acid, or alkali. It will cause the copper pipes and brazed joints to corrode, which can cause refrigerant leakage.
 - Area that can cause combustible gas to leak, contains suspended carbon fibers or flammable dust, or volatile inflammables such as paint thinner or gasoline. If gas leaks and settles around the unit, it can cause a fire.
 - Area where animals may urinate on the unit or ammonia may be generated.
- Do not use the unit for special purposes, such as storing food, raising animals, growing plants, or preserving precision devices or art objects. It can degrade the quality of the preserved or stored objects.
- Do not install where there is the danger of combustible gas leakage.
- Do not install the unit near a source of heat, steam, or flammable gas.
- Install the unit where drainage does not cause any trouble.
- Install the indoor unit, outdoor unit, power supply cable, transmission cable, and remote control cable at least 40 in (1 m) away from a television or radio receivers. The purpose of this is to prevent TV reception interference or radio noise. (Even if they are installed more than 40 in (1 m) apart, you could still receive noise under some signal conditions.)
- Install the unit where ambient temperature does not reach 140 °F (60 °C) or more. Take a measure such as ventilation for an environment in which heat is retained.
- If children under 10 years old may approach the unit, take preventive measures so that they cannot reach the unit.
- Install the indoor unit on the place where the height from the floor is more than 71 in (1.8 m).
- Use the "Insulation kit for high humidity" (option), when the condition under the roof is over 80% in humidity and over 86 °F (30 °C) in temperature. Otherwise, there is a risk of condensation on the ceiling.

- Locate where the air can be distributed evenly throughout the room by the unit.
- The inlet and outlet ports should not be obstructed; the air should be able to blow all over the room.
- Leave the space required to service the air conditioner.
- Install the unit where connection to the outdoor unit is easy.
- Install the unit where the connection pipe can be easily installed.
- Install the unit where the drain pipe can be easily installed.
- Install the unit where noise and vibrations are not amplified.
- Take servicing, etc., into consideration and leave the spaces. Also install the unit where the filter can be removed.
- Do not install the unit where it will be exposed to direct sunlight.

Correct initial installation location is important because it is difficult to move unit after it is installed.

4.2. Installation dimension

- The ceiling rear height as shown in the figure.

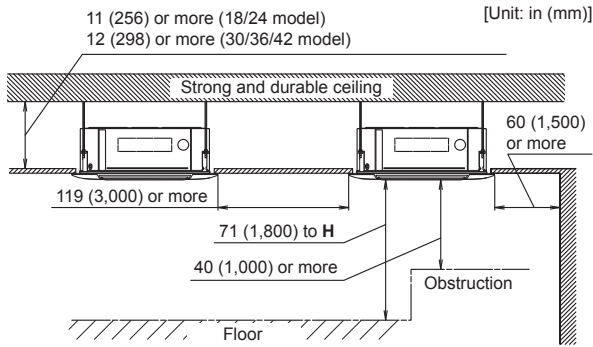

H: Maximum height from floor to ceiling

Function setting	H [in (mm)]	
	18/24 model	30/36/42 model
Standard mode	119 (3,000)	126 (3,200)
High Ceiling mode	138 (3,500)	166 (4,200)

- * Be sure to make the function settings with the remote controller according to the installed ceiling height.

Discharge direction setting

- The discharge direction can be selected as shown below.

4 direction

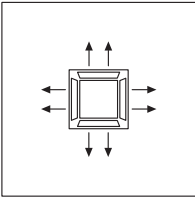

3 direction

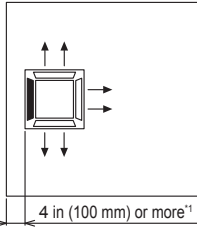

- *1: Please ensure sufficient service access during installation.

- Select the most appropriate airflow direction from 3 or 4 directions according to the shape of the room and the installation position.
- When changing the number of outlets, we recommend using the optional AIR OUTLET SHUTTER PLATE KIT to close the outlet.
- For the specific closing pattern, please refer to the attached AIR OUTLET SHUTTER PLATE KIT'S MANUAL. (Do so before installing the cassette grille as it will be installed on the body.)

4.3. Installing the unit

WARNING

- Install the air conditioner in a location which can withstand a load of at least 5 times the weight of the main unit and which will not amplify sound or vibration. If the installation location is not strong enough, the indoor unit may fall and cause injuries.
- If the job is done with the panel frame only, there is a risk that the unit will come loose. Please take care.
- When fastening the hangers, make the bolt positions uniform.

4.3.1. Position the ceiling hole and hanging bolts

- Positions of the ceiling opening, hanging bolt pitch, piping and ducts.

Ceiling opening and hanging bolt pitch.

[Unit: in (mm)]

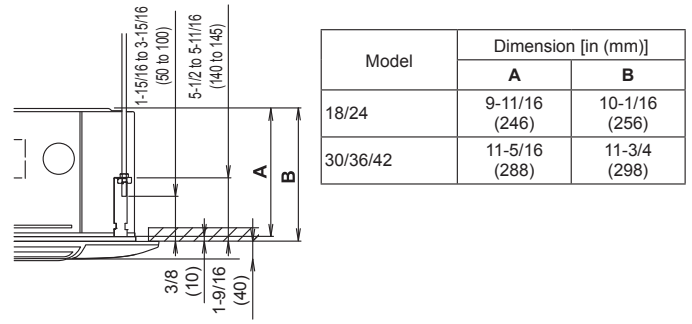
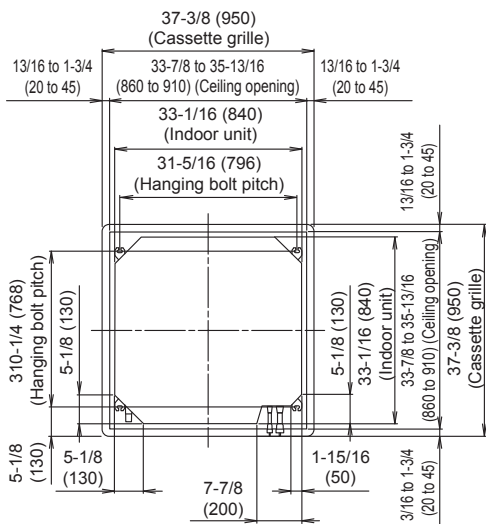

Refrigerant piping and drain piping positions.

[Unit: in (mm)]

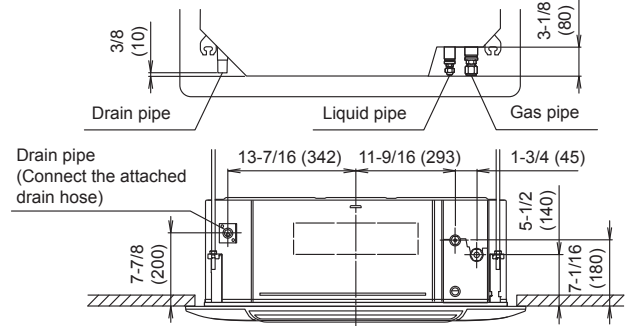

Distribution ducts and fresh air inlet positions.

[Unit: in (mm)]

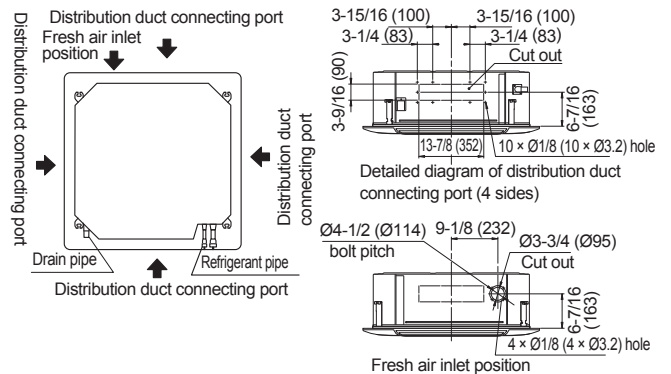

NOTES:

Conduct proper insulation when connecting the distribution ducts and fresh air inlet.

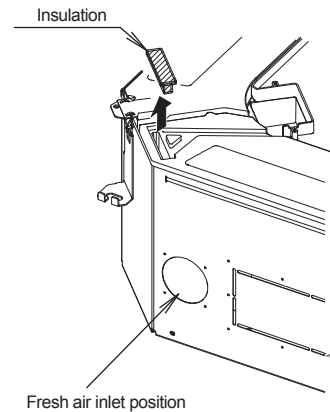

NOTES:

When introducing fresh air into the indoor unit, please remove the insulation affixed to the drain pan.

- Setting the positions of hanging bolt and ceiling opening.
 - Use an installation template (packaging top surface) to set the positions of the hanging bolt and ceiling opening and drill holes.

- Hanging structure.
 - Select a strong structure for the hanging location.
 - If necessary, reinforce the hanging bolt with quake proof columnar support material to prevent shaking.
 - Use hanging bolts of M8-M10.

4.3.2. Hanging preparations

- Firmly fasten the hanging bolts as shown in the figure or by another method.
- Install the hanging bolts at a place where they would be capable of holding a weight of at least 110 lbf (490 N) per bolt.

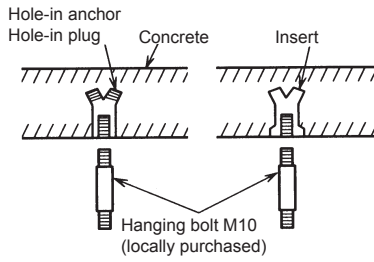

4.3.3. Body installation

WARNING

- Perform final tightening by tightening the double nut firmly.
- Be sure to install the body horizontally and adjust the height below the body and the ceiling surface properly.

- Install the attached washer and nut (prepared on site) onto the hanging bolt.
- Hook the body onto the hanging bolt.
- Adjust the dimensions of the ceiling surface from the body. After installing the Cassette grille, you can make fine adjustment of the height of the body. For details, refer to the installation manual of the Cassette grille.

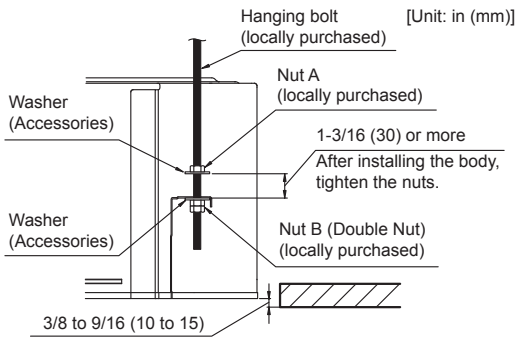

4.3.4. Leveling

Using a level, or vinyl hose filled with water, fine adjust so that the body is level. Inclined installation so as the drain pipe side is higher may cause a malfunction of the float switch, and may cause water leakage.

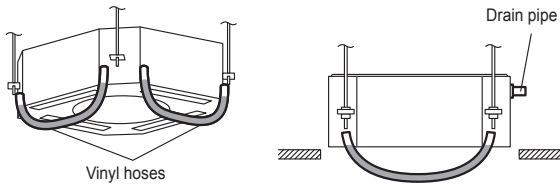

4.4. Installing the drain pipe

WARNING

- Do not insert the drain piping into the sewer where sulfurous gas occurs. (Heat exchange erosion may occur.)
- Insulate the parts properly so that water will not drip from the connection parts.
- Check for proper drainage after the construction by using the visible portion of transparent drain port and the drain piping final outlet on the body.

CAUTION

Do not apply adhesive agent on the drain port of the body. (Use the attached drain hose and connect the drain piping.)

Install the drain pipe:

- Install the drain pipe with downward gradient (1/50 to 1/100) and so there are no rises or traps in the pipe.
- Use general hard polyvinyl chloride pipe (Ø 3/4 in [I.D.]; Ø 1-1/16 in [O.D.]) and connect it with adhesive (polyvinyl chloride) so that there is no leakage.
- When the pipe is long, install supporters.
- Do not perform air bleeding.
- Always heat insulate the indoor side of the drain pipe.
- If it is impossible to have sufficient gradient of pipe, perform drain lift-up.

Pipe size	
Drain pipe	Ø 3/4 in [I.D.]; Ø 1-1/16 in [O.D.]

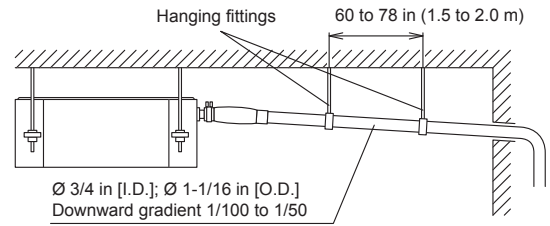

PROHIBITED:

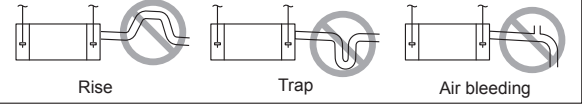

When lifting up drain:

- Height of inclined pipe should be less than 33 in (850 mm) from the ceiling. A rise dimension over this range will cause leakage.
- Lift up the pipe vertically at the position of 11 in (300 mm) or less from the unit.

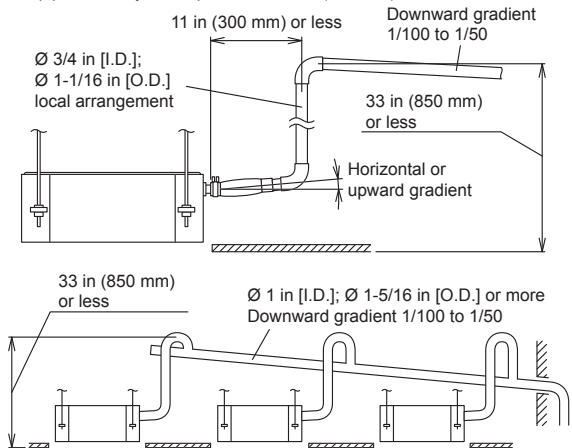

Working procedure

- Install the attached drain hose to the drain port of the body. Attach hose band on top of the drain hose.
- Use vinyl adhesive agent to glue the drain piping (PVC pipe Ø 3/4 in [I.D.]; Ø 1-1/16 in [O.D.]) which is prepared on site or elbow socket. (Apply color adhesive agent evenly until the gauge line and seal.)
- Check the drainage.
- Install the heat insulation.
- Use the attached heat insulation to insulate the drain port and band parts of the body.

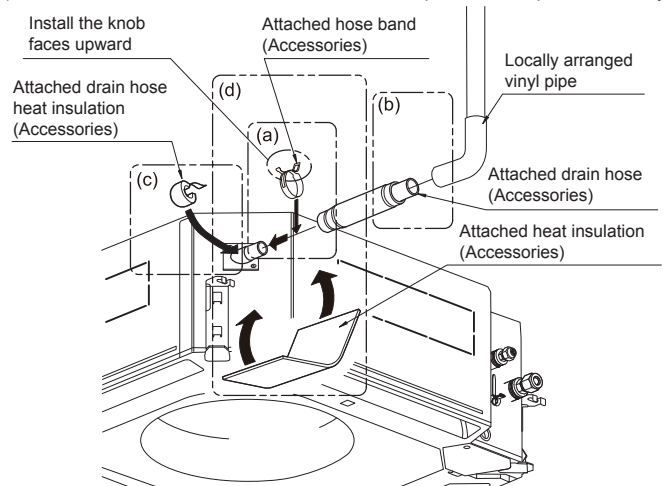

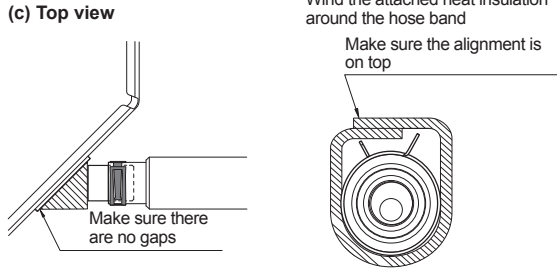
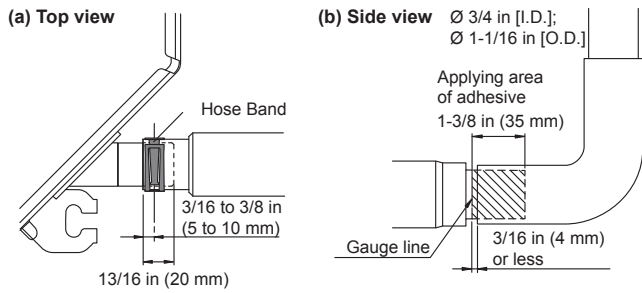

NOTE: Check for drainage

Pour about 1 liter of water from the position shown in the diagram or from the airflow outlet to the dew tray. Check for any abnormalities such as strange noises and whether the drain pump functions normally.

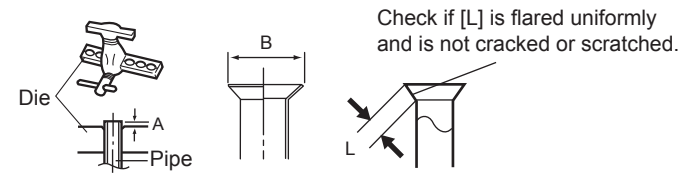
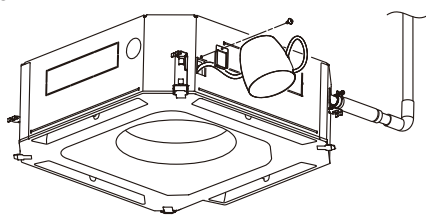

Pipe outside diameter [in (mm)]	Dimension A [in (mm)]	Dimension B ^{0 (0)} _{-0.015 (-0.4)} [in (mm)]
	Flare tool for R410A, clutch type	
1/4 (6.35)	0 to 0.020 (0 to 0.5)	3/8 (9.1)
3/8 (9.52)		1/2 (13.2)
1/2 (12.70)		5/8 (16.6)
5/8 (15.88)		3/4 (19.7)
3/4 (19.05)		15/16 (24.0)

When using conventional (R22) flare tools to flare R410A pipes, the dimension A should be approximately 0.020 in (0.5 mm) more than indicated in the table (for flaring with R410A flare tools) to achieve the specified flaring. Use a thickness gauge to measure the dimension A. It is recommended that a R410A flaring tool is used.

Pipe outside diameter [in (mm)]	Width across flats of Flare nut [in (mm)]
1/4 (6.35)	11/16 (17)
3/8 (9.52)	7/8 (22)
1/2 (12.70)	1 (26)
5/8 (15.88)	1-1/8 (29)
3/4 (19.05)	1-7/16 (36)

5.1.2 Bending pipes

- If pipes are shaped by hand, be careful not to collapse them.
- Do not bend the pipes at an angle more than 90°.
- When pipes are repeatedly bend or stretched, the material will harden, making it difficult to bend or stretch them any more.
- Do not bend or stretch the pipes more than 3 times.

CAUTION

- To prevent breaking of the pipe, avoid sharp bends.
- If the pipe is bent repeatedly at the same place, it will break.

5.1.3. Pipe connection

CAUTION

- Be sure to connect the pipe against the port on the indoor unit and the outdoor unit correctly. If the centering is improper, the flare nut cannot be tightened smoothly. If the flare nut is forced to turn, the threads will be damaged.
- Do not remove the flare nut from the indoor unit pipe until immediately before connecting the connection pipe.
- Do not use mineral oil on flared part. Prevent mineral oil from getting into the system as this would reduce the lifetime of the units.
- Hold the torque wrench at its grip, keeping it at a right angle with the pipe, in order to tighten the flare nut correctly.

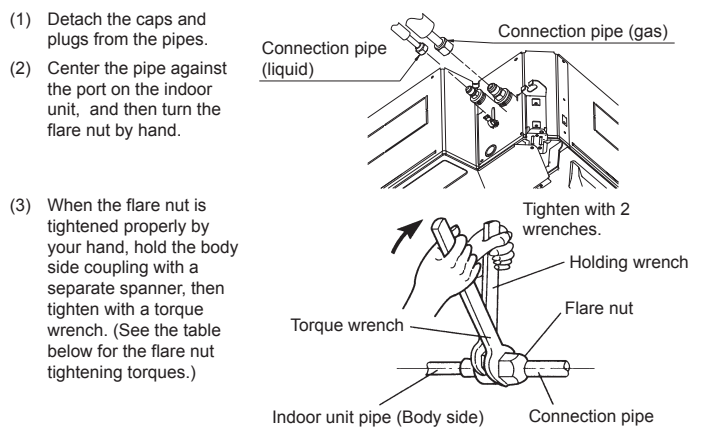

Flare nut [in (mm)]	Tightening torque [lbf-ft (N·m)]
1/4 (6.35) dia.	11.8 to 13.3 (16 to 18)
3/8 (9.52) dia.	23.6 to 31.0 (32 to 42)
1/2 (12.70) dia.	36.1 to 45.0 (49 to 61)
5/8 (15.88) dia.	46.5 to 55.3 (63 to 75)
3/4 (19.05) dia.	66.4 to 81.1 (90 to 110)

5. PIPE INSTALLATION

WARNING

- During installation, make sure that the refrigerant pipe is attached firmly before you run the compressor.
- Do not operate the compressor under the condition of refrigerant piping not attached properly with 2-way or 3-way valve open. This may cause abnormal pressure in the refrigeration cycle that leads to breakage and even injury.
- During the pump-down operation, make sure that the compressor is turned off before you remove the refrigerant piping.
- Do not remove the connection pipe while the compressor is in operation with 2-way or 3-way valve open. This may cause abnormal pressure in the refrigeration cycle that leads to breakage and even injury.
- When installing and relocating the air conditioner, do not mix gases other than the specified refrigerant R410A to enter the refrigerant cycle.
- If air or other gas enters the refrigerant cycle, the pressure inside the cycle will rise to an abnormally high value and cause breakage, injury, etc.
- If refrigerant leaks while work is being carried out, ventilate the area. If the refrigerant comes in contact with a flame, it produces a toxic gas.

CAUTION

- Be more careful so that foreign matter (oil, water, etc.) does not enter the piping than with refrigerant R410A models. Also, when storing the piping, securely seal the openings by pinching, taping, etc.
- While welding the pipes, be sure to blow dry nitrogen gas through them.

5.1. Flare connection (pipe connection)

WARNING

Tighten the flare nuts with a torque wrench using the specified tightening method. Otherwise, the flare nuts could break after a prolonged period, causing refrigerant to leak and generate hazardous gas if the refrigerant comes into contact with a flame.

5.1.1. Flaring

- Use special pipe cutter and flare tool exclusive for R410A.
- (1) Cut the connection pipe to the necessary length with a pipe cutter.
- (2) Hold the pipe downward so that cuttings will not enter the pipe and remove any burrs.
- (3) Insert the flare nut (always use the flare nut attached to the indoor and outdoor units respectively) onto the pipe and perform the flare processing with a flare tool. Leakage of refrigerant may result if other flare nuts are used.
- (4) Protect the pipes by pinching them or with tape to prevent dust, dirt, or water from entering the pipes.

5.2. Installing heat insulation

CAUTION

- After checking for gas leaks (refer to the Installation Manual of the outdoor unit), perform this section.
- Install heat insulation around both the large (gas) and small (liquid) pipes. Failure to do so may cause water leaks.

After checking for gas leaks, insulate by wrapping insulation around the 2 parts (gas and liquid) of the indoor unit coupling, using the Coupler Heat Insulation.

After installing the Coupler Heat Insulation, wrap both ends with vinyl tape so that there is no gap.

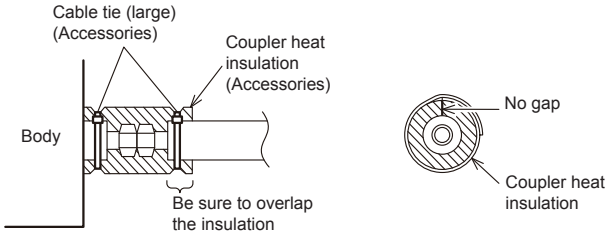

CAUTION

Must fit tightly against body without any gap.

6. ELECTRICAL WIRING

WARNING

- Electrical work must be performed in accordance with this Manual by a person certified under the national or regional regulations. Be sure to use a dedicated circuit for the unit.
- An insufficient power supply circuit or improperly performed electrical work can cause serious accidents such as electric shock or fire.
- Before starting work, check that power is not being supplied to the all units.
- For wiring, use the prescribed type of cables, connect them securely, making sure that there are no external forces of the cables applied to the terminal connections.
- Improperly connected or secured cables can cause serious accidents such as overheating the terminals, electric shock, or fire.
- Use the included connection cables and power cables or ones specified by the manufacturer. Improper connections, insufficient insulation, or exceeding the allowable current can cause electric shock or fire.
- Do not modify the power cables, use extension cables, or use any branches in the wiring. Improper connections, insufficient insulation, or exceeding the allowable current can cause electric shock or fire.
- Match the terminal block numbers and connection cable colors with those of the outdoor unit. Erroneous wiring may cause burning of the electric parts.
- Securely connect the connection cables to the terminal board. In addition, secure the cables with wiring holders. Improper connections, either in the wiring or at the ends of the wiring, can cause a malfunction, electric shock, or fire.
- Always fasten the outside covering of the connection cable with the cable clamp. (If the insulator is chafed, electric leakage may occur.)
- Securely install the electrical box cover on the unit. An improperly installed electrical box cover can cause serious accidents such as electric shock or fire through exposure to dust or water.
- Install sleeves into any holes made in the walls for wiring. Otherwise, a short circuit could result.
- Install a earth (ground) leakage breaker. In addition, install the earth (ground) leakage breaker so that the entire AC main power supply is cut off at the same time. Otherwise, electric shock or fire could result.
- Always connect the earth (ground) cable.
- Improper earthing (grounding) work can cause electric shocks.
- Install the remote controller cables so as not to be touched directly with your hand.
- Perform wiring work in accordance with standards so that the air conditioner can be operated safely and positively.
- Unit shall be earthed (grounded) in compliance with the applicable local and national codes.

CAUTION

- If the indoor unit connection cable and power supply are wired incorrectly, the air conditioner may be damaged or cause malfunction.
- Earth (Ground) the unit.
Do not connect the earth (ground) cable to a gas pipe, water pipe, lightning rod, or a telephone earth (ground) cable.
Improper earthing (grounding) may cause electric shock.
- Do not connect power supply cables to the connection or remote controller terminals, as this will damage the product.
- Never bundle the power supply cable and connection cable together. Bundling these cables together will cause miss operation.

CAUTION

When handling PCB, static electricity charged in the body may cause malfunction of the PCB. Follow the cautions below:

- Establish a ground for the indoor and outdoor units and peripheral devices.
- Cut power (breaker) off.
- Touch metal part of the indoor and outdoor units for more than 10 seconds to discharge static electricity charged in the body.
- Do not touch terminals of parts and patterns implemented on PCB.

6.1. Wiring method

6.1.1. Connection diagrams

Connection cable to outdoor unit

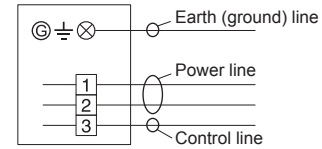

Remote controller cable

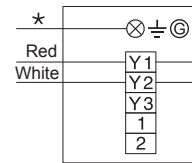

6.1.2. Connection cable preparation

Connection cable

Keep the earth (ground) wire longer than the other wires.

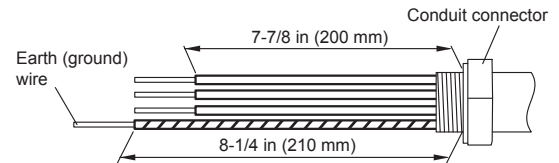

How to connect wiring to the terminals.

- (1) Use ring terminals with insulating sleeves as shown in the figure below to connect to the terminal block.
- (2) Securely crimp the ring terminals to the wires using an appropriate tool so that the wires do not come loose.

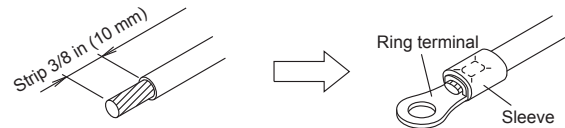

- (3) Use the specified wires, connect them securely, and fasten them so that there is no stress placed on the terminals.
- (4) Use an appropriate screwdriver to tighten the terminal screws.
Do not use a screwdriver that is too small, otherwise, the screw heads may be damaged and prevent the screws from being properly tightened.
- (5) Do not tighten the terminal screws too much, otherwise, the screws may break.
- (6) Refer to the table below for the terminal screw tightening torques.

WARNING

Use ring terminals and tighten the terminal screws to the specified torques, otherwise, it may cause abnormal overheating and possibly cause serious damage inside the unit.

Tightening torque [lbf·in (N·m)]

M4 screw	11 to 16 (1.2 to 1.8)
----------	-----------------------

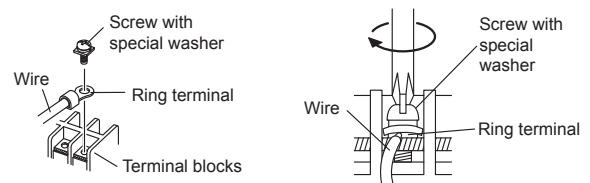

Remote controller cable

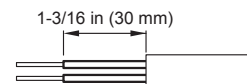

6.1.3. Wiring procedure

Connection cable

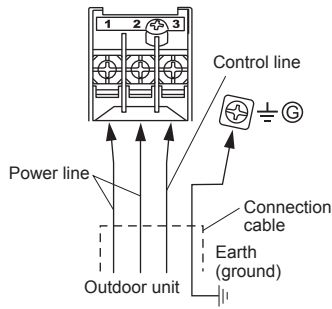

Remote controller cable

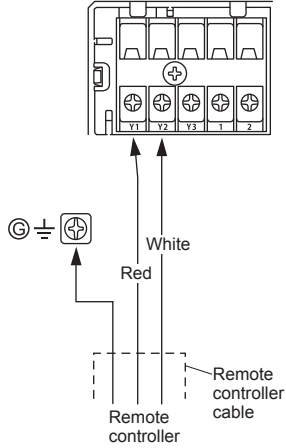

*Earth (Ground) the remote controller if it has a earth (ground) wire.

CAUTION

- Tighten the indoor unit connection wire and power supply indoor and outdoor unit, terminal board connections firmly with the terminal board screws. Faulty connection may cause a fire.
- Connect the indoor unit connection wire by matching the numbers of the outdoor and indoor units terminal board numbers as shown in terminal label.
- Be sure to refer to the connection diagram for the correct field wiring. Wrong wiring causes malfunction of the unit.

6.2. Connection wiring

CAUTION

- Be careful not to mistake the power supply cable and connection wires when installing.
- Install so that the wires for the remote controller will not come in contact with other connection wires.

(1) Remove the control box cover and wiring cover by loosening the screws.

Attach the conduit connector on the wiring connecting port.
(The grommet edging and the connection cable clamp are not used.)

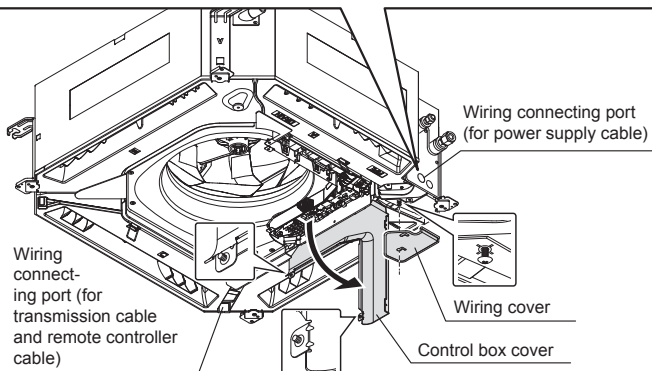
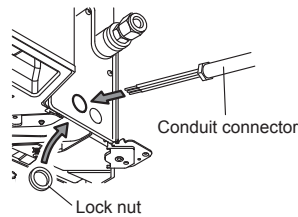

(2) Thread each cable through the holes or indents of the cabinet and connect the wires.

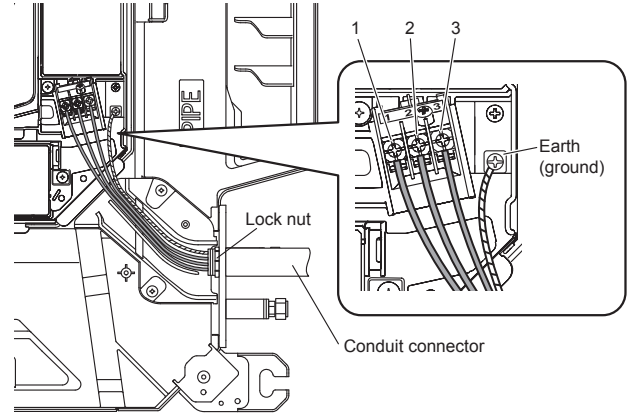

(3) After wiring is complete, secure the cables with the cable clamps.

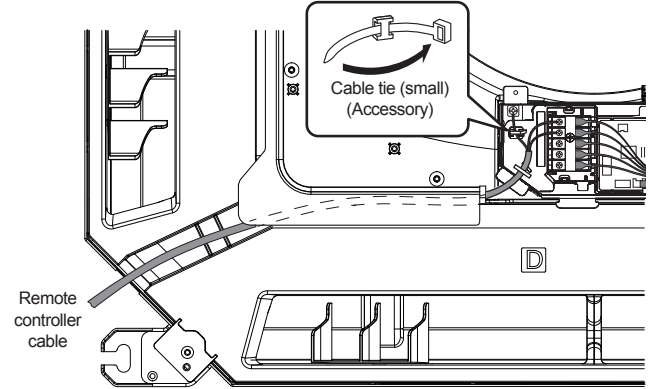

(4) Replace the Control box cover and Wiring cover. Securely tighten the screws.

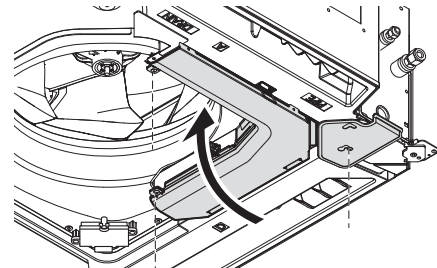

* Cure the wiring connecting port and remote controller connecting port with paste or heat insulation so that insects or dust will not enter the unit

CAUTION

Do not bundle the remote controller cable, or wire the remote controller cable in parallel, with the indoor unit connection wire (to the outdoor unit) and the power supply cable. It may cause erroneous operation.

(5) Fix the conduit with the supporters as shown below.

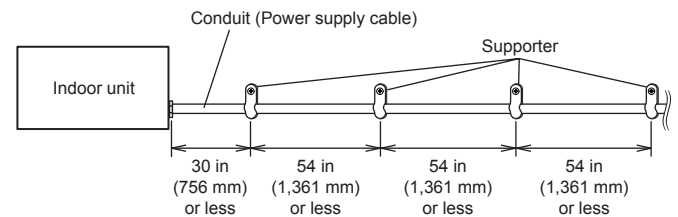

7. CASSETTE GRILLE INSTALLATION

- Install according to the installation manual for Cassette grille.
- Be sure to confirm there is no gap between the panel and main unit after installing the Cassette grille.

8. REMOTE CONTROLLER INSTALLATION

- Install according to the installation manual for Remote controller.

9. FUNCTION SETTING

9.1. Turning on the power

CAUTION

Recheck the wiring. Incorrect wiring will cause trouble.

When initially starting up this unit, the following setting screen will be displayed. Settings configured at this stage can be changed afterwards.

9.2. Setting method

Refer to installation manual of remote controller.

9.3. RC Sensor setting

The detection location of the room temperature can be selected from the following two examples. Choose the detection location that is best for the installation location.

A. Indoor unit setting (factory setting)

The room temperature is detected by the indoor unit temperature sensor.

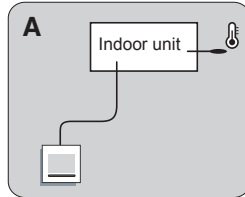

B. Remote controller setting

The room temperature is detected by the remote controller temperature sensor.

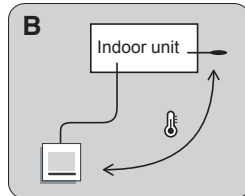

CAUTION

- When selecting the "Remote controller setting", if the detected temperature value between the temperature sensor of the indoor unit and the temperature sensor of the remote controller varies significantly, it is likely to return to the control status of temperature sensor of the indoor unit temporarily.
- As the temperature sensor of remote controller detects the temperature near the wall, when there is a certain difference between the room temperature and the wall temperature, the sensor will not detect the room temperature correctly sometimes. Especially when the outer side of the wall on which the sensor is positioned is exposed to the open air, it is recommended to use the temperature sensor of the indoor unit to detect the room temperature when the indoor and outdoor temperature difference is significant.
- The temperature sensor of the remote controller is not only used when there is a problem in the detection of the temperature sensor of the indoor unit.

9.4. Function Details

Filter sign

Select appropriate intervals for displaying the filter sign on the indoor unit according to the estimated amount of dust in the air of the room.

If the indication is not required, select "No indication" (03).

(Factory setting)

Function number	Setting value	Setting description
11	00	Standard (2500 hours)
	01	Long interval (4400 hours)
	02	Short interval (1250 hours)
	03	No indication

Ceiling height

Select the appropriate ceiling height according to the place of installation.

(Factory setting)

Function number	Setting value	Setting description
20	00	Standard [119 in (3.0 m): 18/24 model] [126 in (3.2 m): 30/36/42 model]
	01	High ceiling [138 in (3.5 m): 18/24 model] [166 in (4.2 m): 30/36/42 model]
	02	Low ceiling [107 in (2.7 m)]

The ceiling height values are for the 4-way outlet.
Do not change this setting in the 3-way outlet mode.

Outlet directions

Select the appropriate number of outlet directions according to the installation conditions.

(Factory setting)

Function number	Setting value	Setting description
22	00	4-way
	01	3-way

Vertical wind direction adjustment range

To prevent draft, change the setting to "Upward" (01).

Note that the airflow in certain usage conditions may leave the ceiling dirty. In such cases, the use of the optional "PANEL SPACER KIT" is recommended.

(Factory setting)

Function number	Setting value	Setting description
23	00	Standard
	01	Upward

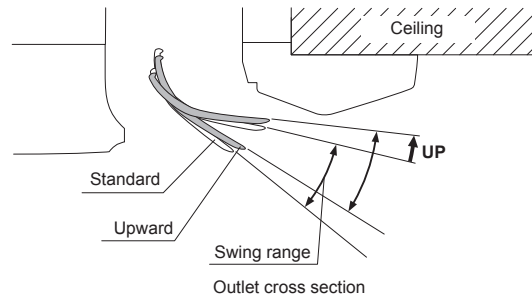

Outlet cross section

Room temperature control for indoor unit sensor

Depending on the installed environment, correction of the room temperature sensor may be required.

Select the appropriate control setting according to the installed environment.

The temperature correction values show the difference from the Standard setting "00" (manufacturer's recommended value).

(Factory setting)

Function number	Setting value	Setting description	
30 (For cooling)	31 (For heating)	00	Standard setting
		01	No correction 0 °F (0.0 °C)
		02	-1 °F (-0.5 °C)
		03	-2 °F (-1.0 °C)
		04	-3 °F (-1.5 °C)
		05	-4 °F (-2.0 °C)
		06	-5 °F (-2.5 °C)
		07	-6 °F (-3.0 °C)
		08	-7 °F (-3.5 °C)
		09	-8 °F (-4.0 °C)
		10	+1 °F (+0.5 °C)
		11	+2 °F (+1.0 °C)
		12	+3 °F (+1.5 °C)
		13	+4 °F (+2.0 °C)
		14	+5 °F (+2.5 °C)
		15	+6 °F (+3.0 °C)
		16	+7 °F (+3.5 °C)
17	+8 °F (+4.0 °C)		

Room temperature control for wired remote controller sensor

Depending on the installed environment, correction of the wire remote temperature sensor may be required.

Select the appropriate control setting according to the installed environment.

To change this setting, set Function 42 to Both "01".

Ensure that the Thermo Sensor icon is displayed on the remote controller screen.

(↔... Factory setting)

Function number	Setting value	Setting description	
35 (For cooling)	36 (For heating)	00	No correction
		01	No correction 0 °F (0.0 °C)
		02	-1 °F (-0.5 °C)
		03	-2 °F (-1.0 °C)
		04	-3 °F (-1.5 °C)
		05	-4 °F (-2.0 °C)
		06	-5 °F (-2.5 °C)
		07	-6 °F (-3.0 °C)
		08	-7 °F (-3.5 °C)
		09	-8 °F (-4.0 °C)
		10	+1 °F (+0.5 °C)
		11	+2 °F (+1.0 °C)
		12	+3 °F (+1.5 °C)
		13	+4 °F (+2.0 °C)
		14	+5 °F (+2.5 °C)
		15	+6 °F (+3.0 °C)
		16	+7 °F (+3.5 °C)
17	+8 °F (+4.0 °C)		

More Cooling
Less Heating

Less Cooling
More Heating

Auto restart

Enable or disable automatic restart after a power interruption.

(↔... Factory setting)

Function number	Setting value	Setting description
40	00	Enable
	01	Disable

* Auto restart is an emergency function such as for power outage etc. Do not attempt to use this function in normal operation. Be sure to operate the unit by remote controller or external device.

Room temperature sensor switching

(Only for wireless remote controller)

When using the Wired remote controller temperature sensor, change the setting to "Both" (01).

(↔... Factory setting)

Function number	Setting value	Setting description
42	00	Indoor unit
	01	Both

00: Sensor on the indoor unit is active.

01: Sensors on both indoor unit and wired remote controller are active.

* Remote controller sensor must be turned on by using the remote controller

Cold air prevention

This setting is to disable the cold air prevention function during heating operation. When disabled, the fan setting will always follow the setting on the remote controller. (Excluding defrost mode)

(↔... Factory setting)

Function number	Setting value	Setting description
43	00	Enable
	01	Disable

Remote controller custom code

(Only for wireless remote controller)

The indoor unit custom code can be changed.

Select the appropriate custom code.

(↔... Factory setting)

Function number	Setting value	Setting description
44	00	A
	01	B
	02	C
	03	D

External input control

"Operation/Stop" mode or "Forced stop" mode can be selected.

(↔... Factory setting)

Function number	Setting value	Setting description
46	00	Operation/Stop mode 1
	01	(Setting prohibited)
	02	Forced stop mode
	03	Operation/Stop mode 2

Room temperature sensor switching (Aux.)

To use the temperature sensor on the wired remote controller only, change the setting to "Wired remote controller" (01). This function will only work if the function setting 42 is set at "Both" (01)

(↔... Factory setting)

Function number	Setting value	Setting description
48	00	Both
	01	Wired remote controller

Indoor unit fan control for energy saving for cooling

Enables or disables the power-saving function by controlling the indoor unit fan rotation when the outdoor unit is stopped during cooling operation.

(↔... Factory setting)

Function number	Setting value	Setting description
49	00	Disable
	01	Enable
	02	Remote controller

00: When the outdoor unit is stopped, the indoor unit fan operates continuously following the setting on the remote controller.

01: When the outdoor unit is stopped, the indoor unit fan operates intermittently at a very low speed.

02: Enable or disable this function by remote controller setting.

Set to "00" or "01" when connecting a remote controller that cannot set the Fan control for energy saving function or connecting a network converter.

To confirm if the remote controller has this setting, refer to the operating manual of each remote controller.

Switching functions for external output terminal

Functions of the external output terminal can be switched.

(↔... Factory setting)

Function number	Setting value	Setting description
60	00	Operation status
	01-08	Other status (refer to Technical manual)
	09	Error status
	10	Indoor unit fan operation status
	11	External heater

Setting record

• Record any changes to the settings in the following table.

Function number	Setting	Setting value
11	Filter sign	
20	Ceiling height	
22	Outlet directions	
23	Vertical wind direction adjustment range	
30	Room temperature control for indoor unit sensor	Cooling
31		Heating
35	Room temperature control for wired remote controller sensor	Cooling
36		Heating
40	Auto restart	
42	Room temperature sensor switching	
43	Cold air prevention	
44	Remote controller custom code	
46	External input control	
48	Room temperature sensor switching (Aux.)	
49	Indoor unit fan control for energy saving for cooling	
60	Switching function for external outlet terminal	

After completing the function setting, be sure to turn off the power and turn it on again.

10. SPECIAL INSTALLATION METHODS

CAUTION

- Be sure to turn off the electrical breaker before making settings.
- Do not set the DIP switch or rotary switch of this unit except as specified in this manual or the operating manual supplied with the air conditioner. Setting the switches other than specified will cause an accident or trouble.
- Do not touch the circuit board and circuit board parts directly with your hands. Otherwise, injury or electric shock could result.
- Use an insulated screwdriver to set the dip switches.

10.1. Setting the address

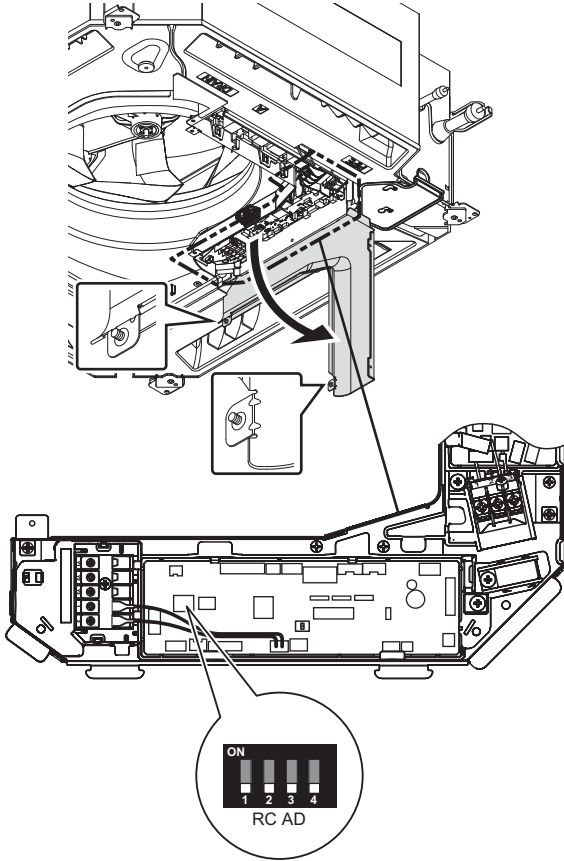

Remote controller address

(1) 2-wire type

DIP switch (RC AD SW)...Factory setting "00"

Since the remote controller address settings are automatically configured, you do not need to configure them.

If configuring manually, it is necessary to configure both the indoor unit and the remote controller. For details, please refer to the remote controller manual.

Setting	Setting range	Type of switch
Remote controller address	00 to 15	Setting example 00 RC AD

Example If 4 indoor units are connected.

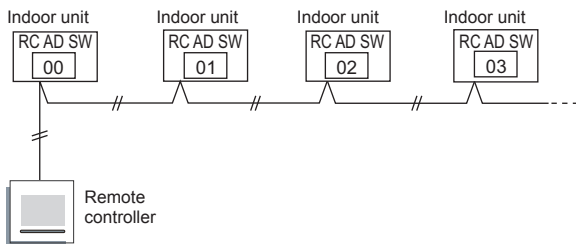

Set the R.C. address in accordance with the table below.

Indoor unit	R.C. address	DIP SWITCH No.			
		1	2	3	4
1	00	OFF	OFF	OFF	OFF
2	01	ON	OFF	OFF	OFF
3	02	OFF	ON	OFF	OFF
4	03	ON	ON	OFF	OFF
5	04	OFF	OFF	ON	OFF
6	05	ON	OFF	ON	OFF
7	06	OFF	ON	ON	OFF
8	07	ON	ON	ON	OFF
9	08	OFF	OFF	OFF	ON
10	09	ON	OFF	OFF	ON
11	10	OFF	ON	OFF	ON
12	11	ON	ON	OFF	ON
13	12	OFF	OFF	ON	ON
14	13	ON	OFF	ON	ON
15	14	OFF	ON	ON	ON
16	15	ON	ON	ON	ON

NOTE

Be sure to set consecutive R.C. address.

The indoor units cannot be operated if a number is skipped.

10.2. Setting the DIP switch

Refer to installation manual of remote controller.

10.3. Group control

CAUTION

Group control is only possible between units with remote controllers of the same type. To confirm the type of remote controller, refer to the back of the remote controller or "2.4. Optional parts".

With a single remote controller, up to 16 units can be simultaneously operated.

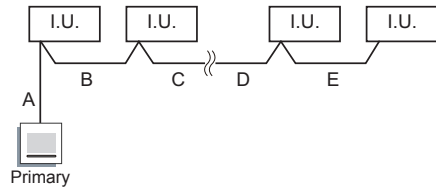

A, B, C, D, E : Remote controller cable. (Refer to 3.3. Electrical requirement.)

$A+B+C+D+E \leq 1640$ ft (500 m)

10.4. Multiple remote control

Up to 2 remote controllers can be used to operate the indoor units.

CAUTION

Multiple installation method described above is prohibited to combine 3 Wired type with 2 Wired Type.

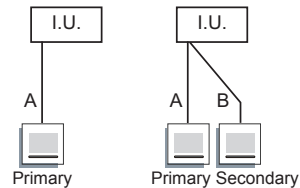

A, B : Remote controller cable. (Refer to 3.3. Electrical requirement.)

$A \leq 1640$ ft (500 m), $A+B \leq 1640$ ft (500 m)

11. OPTION AND OTHER CONNECTABLE DEVICES

⚠ WARNING

Regulation of cable differs from each locality, refer in accordance with local rules.

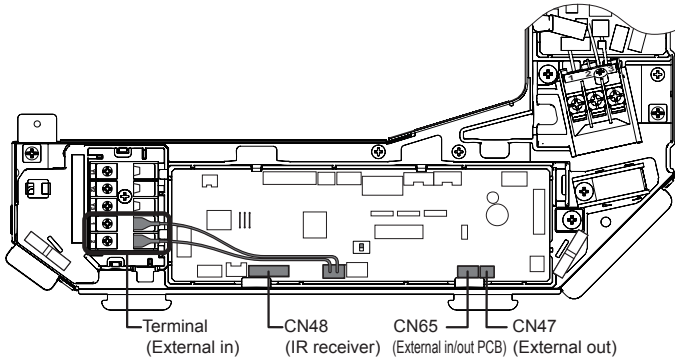

11.1. Optional parts

This air conditioner can be connected with the following optional kits. For details on how to install optional parts, refer to the installation manual included in each item.

Option type	Connector No.
UTY-LBTUC (IR Receiver)	CN48
UTY-XWZXZG (External connect kit)	CN47 ^{*1}
UTY-XCSX (External input and output PCB)	CN65 ^{*2}

*1: For external output terminal setting, refer to Function No.60 in "9. FUNCTION SETTING".
*2: Various settings are available by using the optional External input and output PCB.

11.2. External input and output

11.2.1. External input

- Indoor unit functions such as Operation/Stop or Forced stop can be done by using indoor unit terminals.
- "Operation/Stop" mode or "Forced stop" mode can be selected with function setting of indoor unit.
- A twisted pair cable (22 AWG) should be used. Maximum length of cable is 492 ft (150 m).
- Use an external input and output cable with appropriate external dimension, depending on the number of cables to be installed.
- The wire connection should be separate from the power cable line.

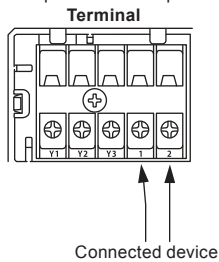

• Dry contact terminal

When a power supply is unnecessary at the input device you want to connect, use the Dry contact terminal.

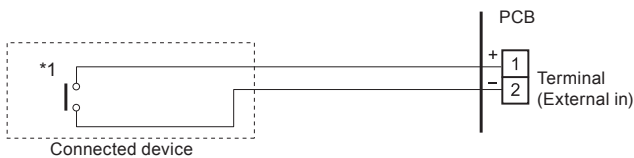

*1: The switch can be used on the following condition: DC 12 V to 24 V, 1 mA to 15 mA.

Operation behavior

• Input signal type

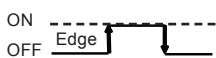

• When function setting is "Operation/Stop" mode 1.

Input signal	Command
OFF → ON	Operation
ON → OFF	Stop

• When function setting is "Forced stop" mode.

Input signal	Command
OFF → ON	Forced stop
ON → OFF	Normal

* When the forced stop is triggered, indoor unit stops and Operation/Stop operation by a remote controller is restricted.

• When function setting is "Operation/Stop" mode 2.

Input signal	Command
OFF → ON	Operation
ON → OFF	Stop (R.C. disabled)

11.2.2. External output

- A twisted pair cable (22AWG) should be used. Maximum length of cable is 82 ft (25 m).
- Use an external input and output cable with appropriate external dimension, depending on the number of cables to be installed.
- Output voltage: Hi DC12V±2V, Lo 0V.
- Permissible current: 50mA

Output select

• When interlocking with external device

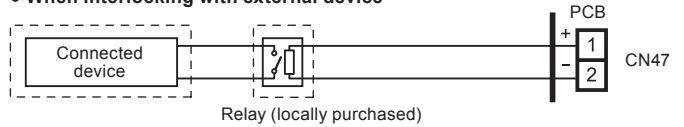

or

• When displaying "Operation/Stop"

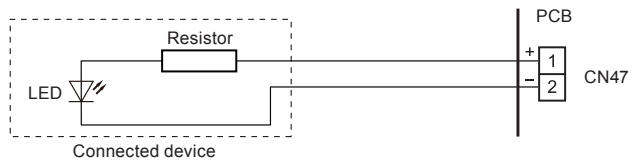

Operation behavior

Function setting	Status	Output voltage
00	Stop	0 V
	Operation	DC 12 V
01 - 05	OFF	0 V
	ON	DC 12 V
06	Stop	0 V
	Operation	DC 12 V
07 - 08	OFF	0 V
	ON	DC 12 V
09	Normal	0 V
	Error	DC 12 V
10	Indoor unit fan stop	0 V
	Indoor unit fan operation	DC 12 V
11	External heater OFF	0 V
	External heater ON	DC 12 V

11.2.3. Connection methods

Wire modification

- Remove insulation from wire attached to wire kit connector.
- Remove insulation from locally purchased cable. Use crimp type insulated butt connector to join field cable and wire kit wire.
- Connect the wire with connecting wire with solder.

IMPORTANT: Be sure to insulate the connection between the wires.

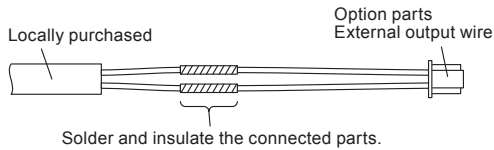

- Connecting wires to the terminals.
Use ring terminals with insulating sleeves to connect to the terminal block.
- Connection terminals and wiring arrangement

In following figure, all the possible connections are done for description.
In actual installation, connections will differ according to each installation requirements.

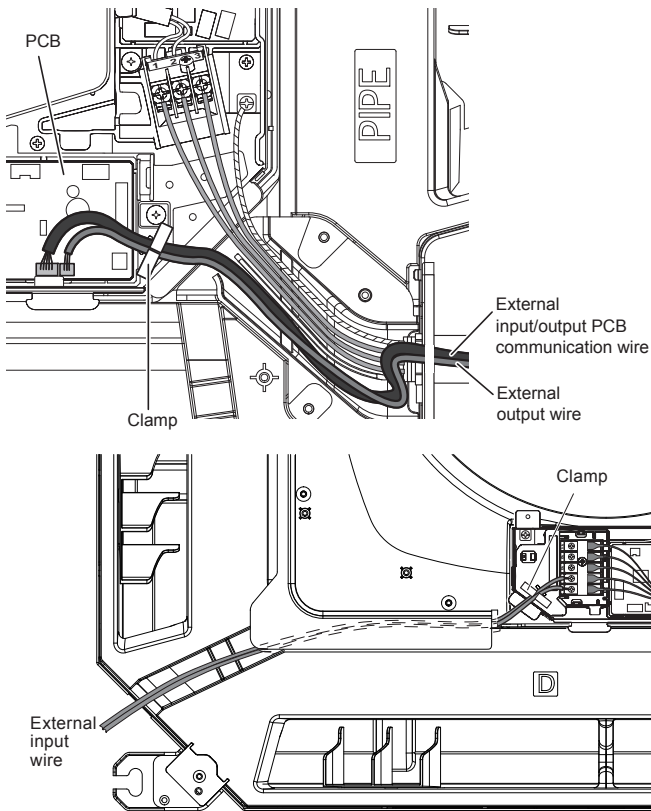

12. CHECK LIST

Pay special attention to the check items below when installing the indoor unit(s). After installation is complete, be sure to check the following check items again.

CHECK ITEMS	If not performed correctly	CHECK BOX
Has the indoor unit been installed correctly?	Vibration, noise, indoor unit may drop	
Has there been a check for gas leaks (refrigerant pipes)?	No cooling, No heating	
Has heat insulation work been completed?	Water leakage	
Does water drain easily from the indoor units?	Water leakage	
Are the wires and pipes all connected completely?	No operation, heat or burn damage	
Is the connection cable the specified thickness?	No operation, heat or burn damage	
Are the inlets and outlets free of any obstacles?	No cooling, No heating	
After installation is completed, has the proper operation and handling been explained to the user?		

13. TEST RUN

Check items

- (1) Is operation of each button on the remote control unit normal?
- (2) Does each lamp light normally?
- (3) Do airflow direction louvers operate normally?
- (4) Is the drain normal?
- (5) Do not have an abnormal noise and vibration during operation?

Do not operate the air conditioner in test run for a long time.

[Operation method]

Depending on your installation, choose from the following:

By the wireless remote controller (with "TEST RUN" button)

- To start test run, press the "START/STOP" button and the "TEST RUN" button on the remote controller.
- To end test run, press the remote controller "START/STOP" button.

By the indoor unit or IR receiver unit

- To start test run, press the "MANUAL AUTO" button of the unit for more than 10 seconds (forced cooling).
- To end test run, press the "MANUAL AUTO" button for more than 3 seconds or press the remote controller "START/STOP" button.

By the wired remote controller

- For the operation method, refer to the installation manual and the operating manual of the wired remote controller.

The Operation indicator lamp and Timer indicator lamp will simultaneously flash during the test run mode.

Heating test run will begin in a few minutes when HEAT is selected by the remote controller [reverse cycle model only].

14. CUSTOMER GUIDANCE

Explain the following to the customer in accordance with the operating manual:

- (1) Starting and stopping method, operation switching, temperature adjustment, timer, air flow switching, and other remote controller unit operations.
- (2) Cleaning and maintenance of the product, and other items such as air filters and air louvers if applicable.
- (3) Give the operating and installation manuals to the customer.
- (4) If the signal code is changed, explain to the customer how it changed (the system returns to signal code A when the batteries in the remote controller unit are replaced).
*(4) is applicable to using wireless remote controller.

15. ERROR CODES

If you use a wired type remote controller, error codes will appear on the remote controller display. For more information, refer to the installation manual of the remote controller. If you use a wireless remote controller, the lamps on the IR receiver unit will output error codes by way of blinking patterns. Refer to the lamp blinking patterns and error codes in the table below. An error display is displayed only during operation.

Operation indicator lamp (green)	Error display		Wired remote controller Error code	Description
	Timer indicator lamp (orange)	Economy indicator lamp (green)		
●(1)	●(1)	◇	11	Serial communication error
●(1)	●(2)	◇	12	Wired remote controller communication error
●(1)	●(5)	◇	15	Check run unfinished
●(1)	●(6)	◇	16	Peripheral unit transmission PCB connection error
●(1)	●(8)	◇	18	External communication error
●(2)	●(1)	◇	21	Unit number or Refrigerant circuit address setting error [Simultaneous Multi]
●(2)	●(2)	◇	22	Indoor unit capacity error
●(2)	●(3)	◇	23	Combination error
●(2)	●(4)	◇	24	• Connection unit number error (indoor secondary unit) [Simultaneous Multi] • Connection unit number error (indoor unit or branch unit) [Flexible Multi]
●(2)	●(6)	◇	26	Indoor unit address setting error
●(2)	●(7)	◇	27	Primary unit, secondary unit setup error [Simultaneous Multi]

Error display			Wired remote controller Error code	Description
Operation indicator lamp (green)	Timer indicator lamp (orange)	Economy indicator lamp (green)		
●(2)	●(9)	◇	29	Connection unit number error in wired remote controller system
●(3)	●(1)	◇	31	Power supply interruption error
●(3)	●(2)	◇	32	Indoor unit PCB model information error
●(3)	●(3)	◇	33	Indoor unit motor electricity consumption detection error
●(3)	●(5)	◇	35	Manual auto switch error
●(3)	●(9)	◇	39	Indoor unit power supply error for fan motor
●(3)	●(10)	◇	3A	Indoor unit communication circuit (wired remote controller) error
●(4)	●(1)	◇	41	Room temp. sensor error
●(4)	●(2)	◇	42	Indoor unit Heat Ex. Middle temp. sensor error
●(4)	●(4)	◇	44	Human sensor error
●(5)	●(1)	◇	51	Indoor unit fan motor error
●(5)	●(3)	◇	53	Drain pump error
●(5)	●(4)	◇	54	Electric air cleaner reverse VDD error
●(5)	●(5)	◇	55	Filter set error
●(5)	●(7)	◇	57	Damper error
●(5)	●(8)	◇	58	Intake grille error
●(5)	●(9)	◇	59	Indoor unit fan motor 2 error (Left side fan)
●(5)	●(10)	◇	5A	Indoor unit fan motor 3 error (Right side fan)
●(5)	●(15)	◇	5U	Indoor unit error
●(6)	●(1)	◇	61	Outdoor unit reverse/missing phase and wiring error
●(6)	●(2)	◇	62	Outdoor unit main PCB model information error or communication error
●(6)	●(3)	◇	63	Inverter error
●(6)	●(4)	◇	64	Active filter error, PFC circuit error
●(6)	●(5)	◇	65	Trip terminal L error
●(6)	●(8)	◇	68	Outdoor unit rush current limiting resistor temp. rise error
●(6)	●(10)	◇	6A	Display PCB microcomputers communication error
●(7)	●(1)	◇	71	Discharge temp. sensor error
●(7)	●(2)	◇	72	Compressor temp. sensor error
●(7)	●(3)	◇	73	Outdoor unit Heat Ex. liquid temp. sensor error
●(7)	●(4)	◇	74	Outdoor temp. sensor error
●(7)	●(5)	◇	75	Suction Gas temp. sensor error
●(7)	●(6)	◇	76	• 2-way valve temp. sensor error • 3-way valve temp. sensor error
●(7)	●(7)	◇	77	Heat sink temp. sensor error

Error display			Wired remote controller Error code	Description
Operation indicator lamp (green)	Timer indicator lamp (orange)	Economy indicator lamp (green)		
●(8)	●(2)	◇	82	• Sub-cool Heat Ex. gas inlet temp. sensor error • Sub-cool Heat Ex. gas outlet temp. sensor error
●(8)	●(3)	◇	83	Liquid pipe temp. sensor error
●(8)	●(4)	◇	84	Current sensor error
●(8)	●(6)	◇	86	• Discharge pressure sensor error • Suction pressure sensor error • High pressure switch error
●(9)	●(4)	◇	94	Trip detection
●(9)	●(5)	◇	95	Compressor rotor position detection error (permanent stop)
●(9)	●(7)	◇	97	Outdoor unit fan motor 1 error
●(9)	●(8)	◇	98	Outdoor unit fan motor 2 error
●(9)	●(9)	◇	99	4-way valve error
●(9)	●(10)	◇	9A	Coil (expansion valve) error
●(10)	●(1)	◇	A1	Discharge temp. error
●(10)	●(3)	◇	A3	Compressor temp. error
●(10)	●(4)	◇	A4	High pressure error
●(10)	●(5)	◇	A5	Low pressure error
●(13)	●(2)	◇	J2	Branch boxes error [Flexible Multi]

Display mode ● : 0.5s ON / 0.5s OFF
◇ : 0.1s ON / 0.1s OFF
() : Number of flashing

[Error code display on the indoor unit (option)]

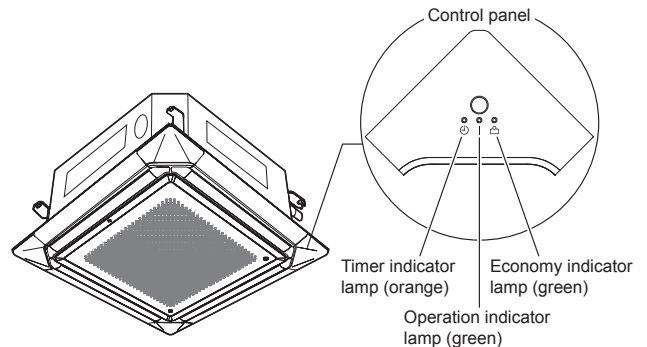

[Error code display on the wired remote controller (option)]

Check the error

- If an error occurs, an error icon appears on the "Monitor mode screen". Touch the [Status] on the "Monitor mode screen". The "Status" screen is displayed.
- Touch the [Error Information] on the "Status" screen. The "Error Information" screen is displayed. (If there are no errors, the [Error Information] will not be displayed.)
- 2-digit numbers correspond to the error code in the table below. Touch the [Next page] (or [Previous page]) to switch to other connected indoor units.

