

**Submittal Data: ARU7RLF
Inverter Driven Heat Pump**

7,000 BTU Slim Duct Type

Job Name: _____

Date: _____

Location: _____

Approval: _____

Engineer: _____

Construction: _____

Submitted to: _____

Unit #: _____

Submitted by: _____

Drawing #: _____

Reference: _____

General Features

- Refrigerant Type R410A.
- Wired and wireless remote controllers
- Auto changeover
- Weekly timer
- Removable open panel
- Super quiet operation
- Removable air filter
- Program timer
- 5 years standard parts warranty
- Eligible for 10 year or 12 year parts warranty. See warranty statement for details.

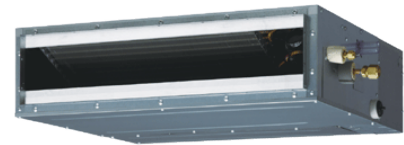

Model Information

Evaporator..... ARU7RLF
 Condenser compatibility..... AOU18RLXFZ, AOU18RLXFZH
 AOU24RLXFZ, AOU24RLXFZH
 AOU36RLXFZ, AOU36RLXFZ1, AOU36RLXFZH
 AOU45RLXFZ, AOU48RLXFZ, AOU48RLXFZ1

Electrical..... 208/230V AC 1ph-60Hz
 Available Voltage Range..... 208/230 +/- 10%
 Minimum Circuit Ampacity..... 0.41 A
 Full Load Amps..... 0.32 A
 Input Power 33 W
 Running Current..... 0.30 A

Capacity
 Nominal Cooling..... 7,000 Btu/h
 Nominal Heating..... 8,100 Btu/h

Fan Motor
 Type: DC Sirocco x2
 Motor Output..... 80 W
 Fan Motor Protection..... off: 275 ± 27°F (135 ± 15°C)
 on: 239 ± 27°F (115 ± 15°C)

Airflow Rate
 Cooling (High / Medium / Low / Quiet)
 324 CFM (550 m3/h) / 288 CFM (490 m3/h) / 277 CFM (470 m3/h) / 259 CFM (440 m3/h)
 Heating (High / Medium / Low / Quiet)
 324 CFM (550 m3/h) / 288 CFM (490 m3/h) / 277 CFM (470 m3/h) / 259 CFM (440 m3/h)

Heat Exchanger
 Dimensions
 (H x W x D) in. (mm)11-9/16 x 19-11/16 x 1-1/16 (294x500x26.6)
 Fin Pitch..... 20 FPI
 Rows x Stages..... 3 x 14
 Pipe Type (Material)..... Copper
 Type (Material)..... Polystyrene

Temperature Setting Range

Cooling..... 64°F - 90°F (18°C - 32 °C)
 Heating..... 60°F - 88°F (16°C - 30°C)

Enclosure

Material..... Galvanized Steel Sheet

Sound Pressure Level

Cooling
 High/Medium/Low/Quiet..... 28 dB (A) / 26 dB (A) / 25 dB (A) / 24 dB (A)
 Heating
 High/Medium/Low/Quiet..... 28 dB (A) / 26 dB (A) / 25 dB (A) / 24 dB (A)

Dimensions

H x W x D
 in. (mm)..... 7-13/16 x 27-9/16 x 24-7/16 (198x700x620)

Connection Pipe

Liquid..... 1/4" in. (6.35 mm)
 Gas..... 3/8" in. (9.52 mm)
 Method (Liquid/Gas)..... Flare

Drain hose
 Material..... Hard PVC
 Size..... Ø1 (I.D.), Ø1-1/4 (O.D.) [Ø25 (I.D.), Ø32 (O.D.) mm]

Weight

Net..... 37 lbs. (17 kg)
 Gross..... 49 lbs. (22 kg)

Accessories

Wired Remote Controller..... UTY-RNNUM
 Backlit Display..... UTY-RVNUM
 Simple Remote Controller..... UTY-RSNUM
 Remote Sensor..... UTY-XSZZ
 Receiver Unit..... UTY-LRHUM
 Slim Duct Connector Kit..... UTD-ECS5A

Intertek®ETL Number

ARU7RLF..... 3170288

Note: Specifications are based on the following conditions:
 Cooling: Indoor temperature of 80°F (26.7°C) DB/67°F (19.44°C) WB, and outdoor temperature of 95°F (35°C) DB/75°F (23.9°C) WB.
 Heating: Indoor temperature of 70°F (21.11°C) DB/59°F (15°C) WB, and outdoor temperature of 47°F (8.33°C) DB/43°F (6.11°C) WB.
 Pipe length: 24ft. 7in. (7.5m), Height difference: 0ft. (0m) (Outdoor unit – indoor unit)



Dimensions: ARU7RLF

[Unit: in. (mm)]

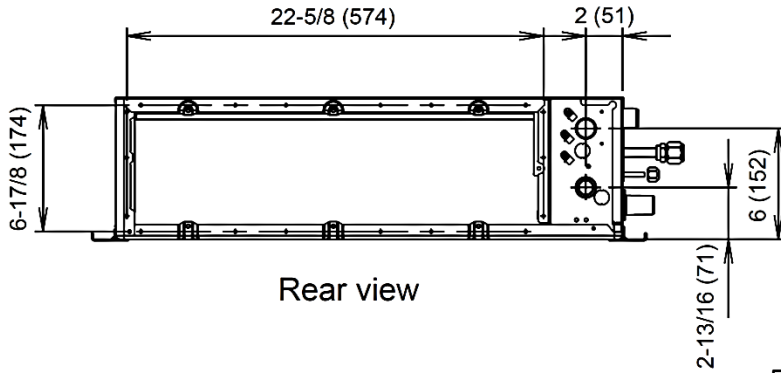

Rear view

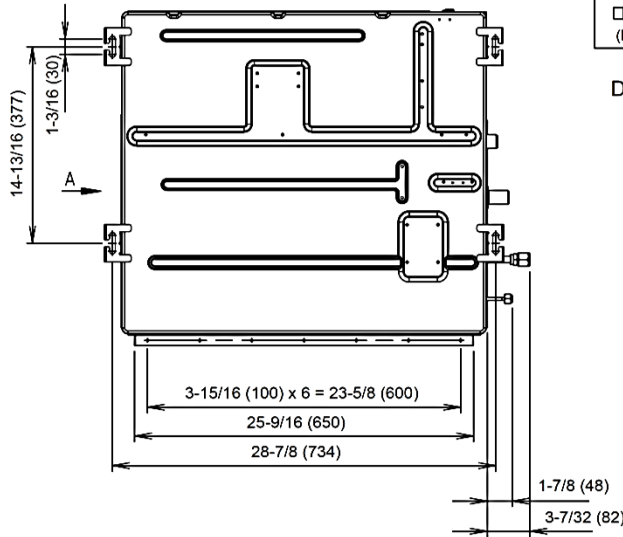
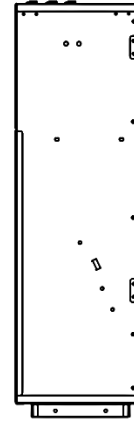

Top view

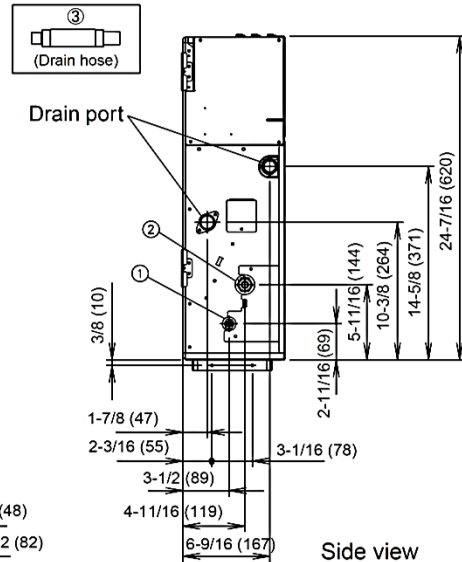

Side view

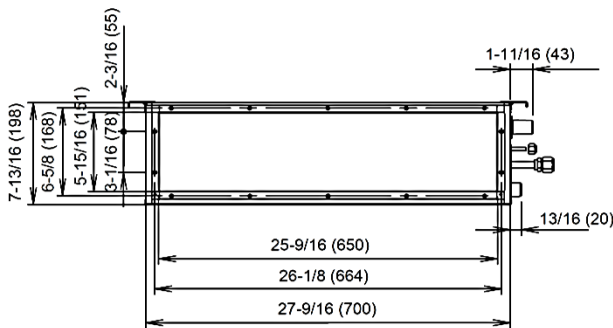

Front view

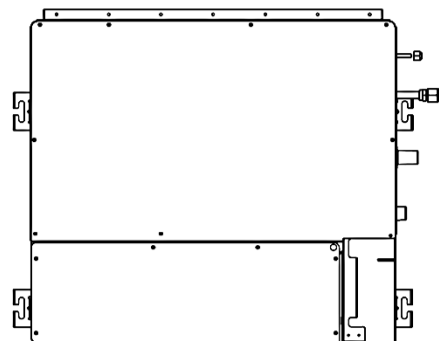

Bottom view

Dimensions: ARU7RLF

■ Installation Place

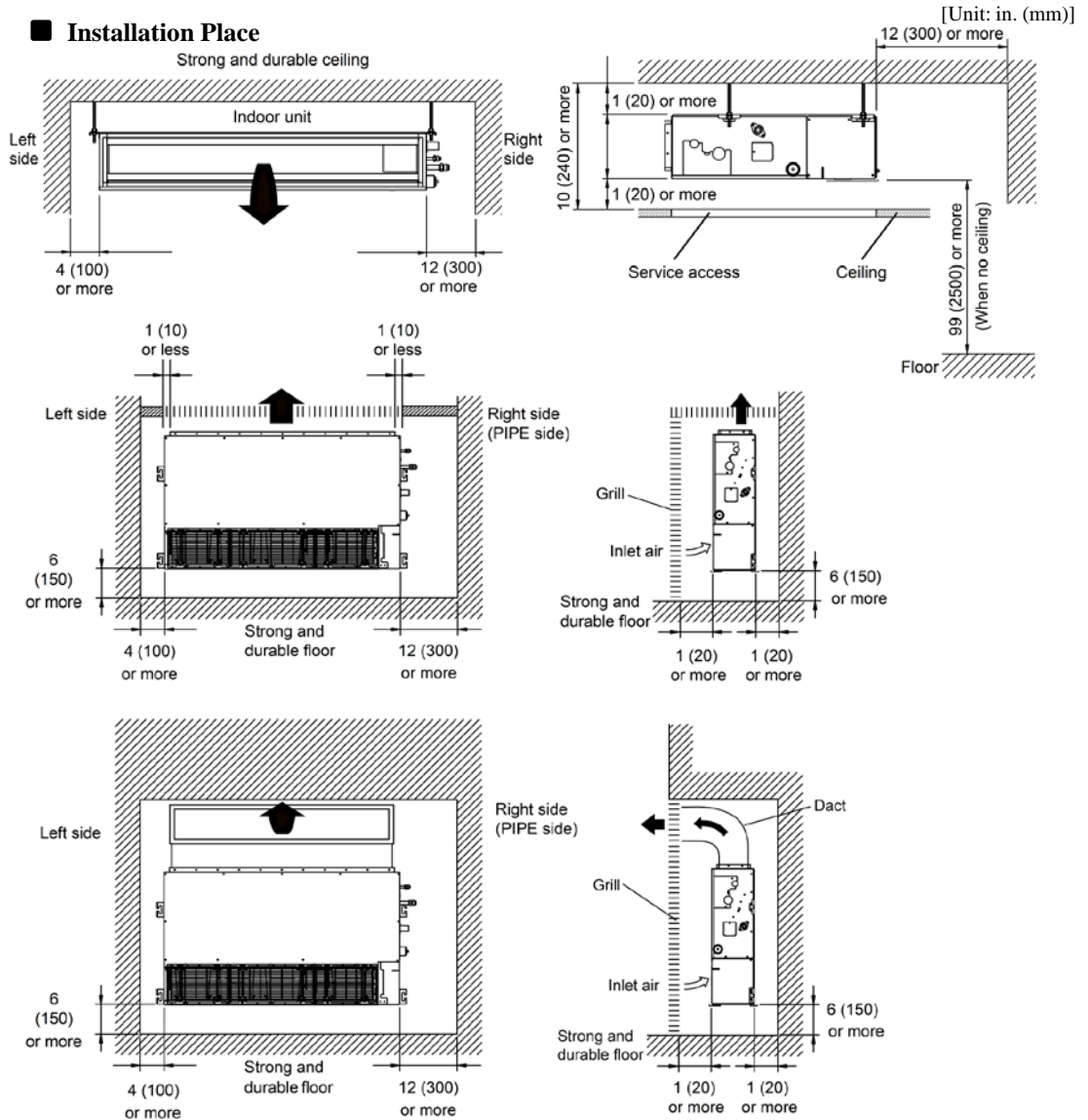

■ Maintenance Space

Provide a service access for inspection purposes as shown below. Do not place any wiring or illumination in the service space, as they will impede service.

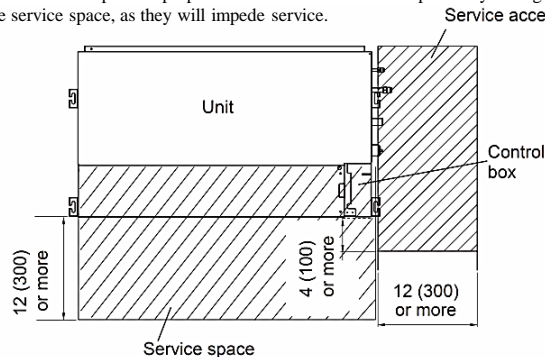

Dimensions: ARU7RLF

■ Fan Performance Curve

