

**AOU36RLAVS**  
**AOU48RLAVS**

## **INSTALLATION MANUAL**

OUTDOOR UNIT

For authorized service personnel only.

English

## **MANUEL D'INSTALLATION**

UNITÉ EXTÉRIEURE

Pour le personnel de service agréé uniquement.

Français

## **MANUAL DE INSTALACIÓN**

UNIDAD EXTERIOR

Únicamente para personal de servicio autorizado.

Español



# INSTALLATION MANUAL

VRF system outdoor unit  
PART No. 9380545187-02

## Contents

1. SAFETY PRECAUTIONS .....	1
2. ABOUT THIS PRODUCT .....	2
2.1. Precautions for using R410A refrigerant .....	2
2.2. Special tools for R410A .....	3
2.3. Accessories .....	3
2.4. Optional parts .....	3
2.5. About unit of the length .....	3
3. INSTALLATION WORK .....	3
3.1. Selecting an installation location .....	3
3.2. Drain processing .....	3
3.3. Installation dimensions .....	4
3.4. Transporting the unit .....	4
3.5. Installing the unit .....	4
4. SYSTEM CONFIGURATION .....	5
4.1. System configuration .....	5
4.2. Pipe selection .....	5
4.3. Protection of pipes .....	5
5. PIPE INSTALLATION .....	5
5.1. Brazing .....	5
5.2. Indoor unit pipe connections .....	6
5.3. Opening the knockout hole .....	6
5.4. Pipe connection .....	6
6. ELECTRICAL WIRING .....	7
6.1. The precautions of electrical wiring .....	7
6.2. Knockout hole .....	8
6.3. Selecting power supply cable and breaker .....	8
6.4. Transmission line .....	8
6.5. Wiring method .....	9
6.6. External input and external output .....	10
7. FIELD SETTING .....	11
7.1. Field setting switches .....	11
7.2. DIP switch setting .....	11
7.3. Rotary switch setting .....	11
7.4. Push button setting .....	11
7.5. Address setting for signal amplifiers .....	13
7.6. Indoor unit address setting .....	13
7.7. Resistance measurement of transmission cable (Measure with breaker OFF) .....	14
8. PIPE INSTALLATION II .....	14
8.1. Sealing test .....	14
8.2. Vacuum process .....	14
8.3. Additional charging .....	15
8.4. Installing insulation .....	15
8.5. Filling with putty .....	15
9. TEST RUN .....	16
9.1. Indoor unit connection check .....	16
9.2. Test run .....	16
9.3. Test run method .....	16
9.4. Checklist .....	17
10. LED STATUS .....	17
10.1. Normal operation codes .....	17
10.2. Error codes .....	17

## 1. SAFETY PRECAUTIONS

This installation manual describes how to install the outdoor unit only. To install the indoor unit, refer to the installation manual included with the indoor unit.

### IMPORTANT!

#### Please Read Before Starting

This air conditioning system meets strict safety and operating standards. As the installer or service person, it is an important part of your job to install or service the system so it operates safely and efficiently.

#### For safe installation and trouble-free operation, you must:

- Carefully read this instruction booklet before beginning.
- Follow each installation or repair step exactly as shown.
- Observe all local, state, and national electrical codes.
- Pay close attention to all danger, warning, and caution notices given in this manual.

**WARNING:** This symbol refers to a hazard or unsafe practice which can result in severe personal injury or death.

**CAUTION:** This symbol refers to a hazard or unsafe practice which can result in personal injury and the potential for product or property damage.

- Hazard alerting symbols



Electrical



Safety / alert

#### If Necessary, Get Help

These instructions are all you need for most installation sites and maintenance conditions. If you require help for a special problem, contact our sales/service outlet or your certified dealer for additional instructions.

#### In Case of Improper Installation

The manufacturer shall in no way be responsible for improper installation or maintenance service, including failure to follow the instructions in this document.

### SPECIAL PRECAUTIONS

#### When Wiring

**ELECTRICAL SHOCK CAN CAUSE SEVERE PERSONAL INJURY OR DEATH. ONLY A QUALIFIED, EXPERIENCED ELECTRICIAN SHOULD ATTEMPT TO WIRE THIS SYSTEM.**

- Do not supply power to the unit until all wiring and tubing are completed or reconnected and checked.
- Highly dangerous electrical voltages are used in this system. Carefully refer to the wiring diagram and these instructions when wiring. Improper connections and inadequate earthing (grounding) can cause accidental injury or death.
- Earth (ground) the unit following local electrical codes.
- Connect all wiring tightly. Loose wiring may cause overheating at connection points and a possible fire hazard.

#### When Transporting

Be careful when picking up and moving the indoor and outdoor units. Get a partner to help, and bend your knees when lifting to reduce strain on your back. Sharp edges or thin aluminum fins on the air conditioner can cut your fingers.

#### When Installing...

##### ...In a Ceiling or Wall

Make sure the ceiling/wall is strong enough to hold the unit's weight. It may be necessary to construct a strong wood or metal frame to provide added support.

##### ...In a Room

Properly insulate any tubing run inside a room to prevent "sweating" that can cause dripping and water damage to walls and floors.

##### ...In Moist or Uneven Locations

Use a raised concrete pad or concrete blocks to provide a solid, level foundation for the outdoor unit. This prevents water damage and abnormal vibration.

##### ...In an Area with High Winds

Securely anchor the outdoor unit down with bolts and a metal frame. Provide a suitable air baffle.

##### ...In a Snowy Area (for Heat Pump-type Systems)

Install the outdoor unit on a raised support that is higher than drifting snow. Provide snow vents.

## When Connecting Refrigerant Tubing

- Keep all tubing runs as short as possible.
- Use the brazing method for connecting tubing.
- Apply refrigeration compressor oil (or equivalent) used for the outdoor unit to the matching surfaces of the flare and union tubes before connecting them, then tighten the nut with a torque wrench for a leak free connection.
- Check carefully for leaks before starting the test run.

## When Servicing...

- Turn the power OFF at the main circuit breaker panel before opening the unit to check or repair electrical parts and wiring.
- Keep your fingers and clothing away from any moving parts.
- Clean up the site after you finish, remembering to check that no metal scraps or bits of wiring have been left inside the unit being serviced.
- After installing the unit, perform a test run to make sure the unit operates normally. Then, explain to the customer how to operate and maintain the unit.
- Please pass this Installation manual together with the Operating manual to the customer. Please ask the customer to keep the Operating manual and Installation manual at hand for future reference during the moving or repair of the main unit.

### WARNING

For installation purposes, be sure to use the parts supplied by the manufacturer or other prescribed parts.

Using non-specified parts will cause serious accidents such as falling unit, refrigerant leakage, water leakage, electric shock, and fire.

To install a unit that uses the R410A refrigerant, use dedicated tools and piping materials that have been manufactured specifically for R410A use.

Because the pressure of the R410A refrigerant is approximately 1.6 times higher than the R22, failure to use dedicated piping material or improper installation can cause rupture or injury.

It will also cause serious accidents such as refrigerant leakage, water leakage, electric shock, and fire.

Do not introduce any substance other than the prescribed refrigerant into the refrigeration cycle.

If air enters the refrigeration cycle, the pressure in the refrigeration cycle will become abnormally high and cause the piping to rupture.

Ensure that the outdoor unit is securely installed at a place that can withstand the weight of the unit.

Improper installation will cause injuries caused by falling unit.

If there is a refrigerant leakage, make sure that it does not exceed the concentration limit.

If a refrigerant leakage exceeds the concentration limit, it can lead to accidents such as oxygen starvation.

If a refrigerant leakage occurs during operation, immediately vacate the premises and thoroughly ventilate the area.

If the refrigerant is exposed to fire, it will create a hazardous gas.

Electrical work must be performed in accordance with this Installation manual by a person certified under the national or regional regulations. Be sure to use a dedicated circuit for the unit.

For wiring, use the prescribed type of cables, connect them securely, making sure that there are no external forces of the cables applied to the terminal connections. Improperly connected or secured cables can cause serious accidents such as overheating the terminals, electric shock, or fire.

Do not turn ON the power until all work has been completed.

After the installation, make sure there is no refrigerant leakage.

If the refrigerant leaks into the room and becomes exposed to a source of fire such as a fan heater, stove, or burner, it will create a hazardous gas.

Use a wall hole pipe. Otherwise, it may cause a short circuit.

Do not place the outdoor unit near the handrail of the balcony.

Children may climb onto the outdoor unit, lean over the handrail and fall over.

Use only a specified power cable. Poor connection, poor insulation, and exceeding the allowable current will lead to electric shock and fire.

Install a breaker to cut off all AC main current at the same time.

If you do not install a breaker, it may cause electric shock and fire.

Be sure to install the refrigerant pipe before operating the compressor. If the refrigerant pipe is not installed and you operate the compressor while the valve is open, air will be sucked into the system and abnormal pressure will occur in the refrigerant cycle. This will damage the unit and cause injuries.

During the pump-down operation, make sure that the compressor is turned off before you remove the refrigerant piping. Do not remove the connection pipe while the compressor is in operation with 2-way or 3-way valve open. This may cause abnormal pressure in the refrigeration cycle that leads to breakage and even injury.

If there is a possibility of touching the fan during maintenance, make sure to turn OFF the power before implementing the maintenance. Even if operations are suspended, the fan of outdoor unit sometimes rotates, so if the fan rotates suddenly while in contact with you may cause serious injury.

Installation must be performed in accordance with the requirement of NEC (National Electrical Code) and CEC (Canadian Electrical Code) by authorized personnel only.

### CAUTION

This unit must be installed by qualified personnel with a capacity certificate for handling refrigerant fluids. Refer to regulation and laws in use on installation place.

The installation must be carried out in compliance with regulations in force in the place of installation and the installation instructions of the manufacturer.

This unit is part of a set constituting an air conditioner. It must not be installed alone or with non-authorized by the manufacturer.

This unit contains no user-serviceable parts. Always consult authorized service personnel to repairs.

When moving, consult authorized service personnel for disconnection and installation of the unit.

- Obtain the distribution network operator's agreement about the power capacity of the power supply system, specification of the cable and the harmonic current, and etc. when you connect the outdoor unit with the power supply.
- This unit must be connected to a power supply with impedance of 0.398 ohm and below. If the power supply does not satisfy this requirement, please consult the power supplier.
- This product is intended for professional use.  
Be sure to use a dedicated power circuit.  
Never use a power supply shared by another appliance.

Do not install the unit in the following areas:

- Area with high salt content, such as at the seaside. It will deteriorate metal parts, causing the parts to fail or the unit to leak water.
- Area filled with mineral oil or containing a large amount of splashed oil or steam, such as a kitchen. It will deteriorate plastic parts, causing the parts to fail or the unit to leak water.
- Area that generates substances that adversely affect the equipment, such as sulfuric gas, chlorine gas, acid, or alkali. It will cause the copper pipes and brazed joints to corrode, which can cause refrigerant leakage.
- Area containing equipment that generates electromagnetic interference. It will cause the control system to malfunction, preventing the unit from operating normally.
- Area that can cause combustible gas to leak, contains suspended carbon fibers or flammable dust, or volatile inflammables such as paint thinner or gasoline. If gas leaks and settles around the unit, it can cause a fire.
- Avoid installing the unit at places where it will come into contact with animals' urine or ammonia.

The units are not explosion proof and therefore should not be installed in explosive atmosphere.

Do not use the unit for special purposes, such as storing food, raising animals, growing plants, or preserving precision devices or art objects. It can degrade the quality of the preserved or stored objects.

Perform draining for the unit according to the Installation manual. Check that the water is properly drained. If the drain processing is improperly installed, water may drip down from the unit, wetting the furniture.

Be sure not to start or stop the operation of air conditioning with power breaker. Otherwise, it may cause malfunction or water leakage.

When setting it up near the equipment that generates electromagnetic waves and the equipment that generates the higher harmonics wave, be sure to take measures against noise. Otherwise, it may cause malfunction or failure.

When energizing to the crankcase heater, please turn on the power 12 hours or earlier before operation begins. When the energizing time is short, it may cause failure. Besides, please do not turn off power during the busy season.

Children should be monitored to ensure they do not play with the device.

This product is not intended to be used by people (including children) with physical, sensory or mental disability, or persons lacking experience or knowledge unless they have been given by the through a person responsible for their safety, supervision or instruction concerning the use of the device.

## 2. ABOUT THIS PRODUCT

### 2.1. Precautions for using R410A refrigerant

Pay careful attention to the following points:

Since the working pressure is 1.6 times higher than that of R22 models, some of the piping and installation and service tools are special. (See the table in the SPECIAL TOOLS FOR R410A section.)

Especially, when replacing a conventional refrigerant (other than R410A) model with a new refrigerant R410A model, always replace the conventional piping and flare nuts with the R410A piping and flare nuts.

Models that use refrigerant R410A have a different charging port thread diameter to prevent erroneous charging with R22, R407C and for safety. Therefore, check beforehand. [The charging port thread diameter for R410A is 1/2 UNF 20 threads per inch.]

Be more careful than the installation of the refrigerant (other than R410A) models, not to enter foreign matters (oil, water, etc.) and other refrigerant into the piping. Also, when storing the piping, securely seal the openings by pinching, taping, etc.

When charging the refrigerant, take into account the slight change in the composition of the gas and liquid phases, and always charge from the liquid phase side whose composition is stable.







## 2.2. Special tools for R410A

Tool name	Contents of change for R22 tool
Gauge manifold	Pressure is huge and cannot be measured with a conventional gauge. To prevent erroneous mixing of other refrigerants, the diameter of each port has been changed. It is recommended to use a gauge manifold with a high pressure display range 30 inHg to 768 psi (-0.1 to 5.3 MPa) and a low pressure display range 30 inHg to 551 psi (-0.1 to 3.8 MPa).
Charging hose	To increase pressure resistance, the hose material and base size were changed.
Vacuum pump	A conventional vacuum pump can be used by installing a vacuum pump adapter. <ul style="list-style-type: none"> <li>A conventional vacuum pump can be used by installing a vacuum pump adapter.</li> <li>Be sure that the pump oil does not back flow into the system. Use one capable for vacuum suction of 30 inHg (-100.7 kPa).</li> </ul>
Gas leakage detector	Special gas leakage detector for HFC refrigerant R410A.

## 2.3. Accessories

Use connecting parts as required.

Do not throw away the connecting parts until the installation has been complete.

Name and shape	Q'ty	Application
Specifications manual 	1	—
Installation manual 	1	(This book)
Drain cap 	7	For outdoor unit drain piping work
Drain pipe 	1	For outdoor unit drain piping work
Cable tie 	4	For binding power cable and transmission cable
Conduit plate 	1	To fix Conduit tube

## 2.4. Optional parts

### CAUTION

The following parts are optional parts specific to R410A refrigerant. Do not use parts other than those listed below.

### 2.4.1. Separation tube kit

Separation tube uses the following parts.

Separation tube	Total cooling capacity of indoor unit [BTU/h]
UTP-AX054A	ALL

### 2.4.2. Header

Header uses the following parts. A header is used for connecting the indoor units.

Header		Total cooling capacity of indoor unit [BTU/h]
3-6 Branches	3-8 Branches	
UTR-H0906L	UTR-H0908L	ALL

### 2.4.3. External connect kit

Model	Usage
UTY-XWZXZ6	For External input (CN131, CN132, CN133, CN134)
	For External output (Error status / CN136) (Operation status / CN137)
UTY-XWZXZF	For External input (CN135)
UTY-XWZXZ9	For External output (Base heater / CN115)

## 2.5. About unit of the length

All Fujitsu General products are manufactured to metric units and tolerances. United States customary units are provided for reference only. In cases where exact dimensions and tolerances are required, always refer to metric units.

## 3. INSTALLATION WORK

Please obtain the approval of the customer when selecting the location of installation and installing the main unit.

### 3.1. Selecting an installation location

#### WARNING

Install the unit in a location that can withstand its weight, and where it will not topple or fall.

Calculate the proper refrigerant concentration if you will be installing it in an enclosed location.

$$\frac{\text{Total amount of replenished refrigerant in refrigerant facility [lb (kg)]}}{\text{Capacity of smallest room where unit is installed [1,000 ft}^3 \text{ (m}^3\text{)]}} \leq \frac{\text{Refrigerant concentration [lb/1,000 ft}^3 \text{ (kg/m}^3\text{)]}}{[25 \text{ lb/1,000 ft}^3 \text{ (0.40 kg/m}^3\text{)]}}$$

If the results of the calculation exceed the concentration limit, increase the room surface area or install a ventilation duct.

#### CAUTION

Please install the outdoor unit without slant. (within 3 degrees)

Install this unit in a location with good ventilation.

If the unit must be installed in an area within easy reach of the general public, install as necessary a protective fence or the like to prevent their access.

Install the unit in an area that would not inconvenience your neighbors, as they could be affected by the airflow coming out from the outlet, noise, or vibration. If it must be installed in proximity to your neighbors, be sure to obtain their approval.

If the unit is installed in a cold region that is affected by snow accumulation, snow fall, or freezing, take appropriate measures to protect it from those elements. To ensure a stable operation, install inlet and outlet ducts.

Install the unit in an area that would not cause problems even if the drain water is discharged from the unit. Otherwise, provide drainage that would not affect people or objects.

Install the unit in an area that has no heat sources, vapors, or the risk of the leakage of flammable gas in the vicinity.

Install the unit in an area that is away from the exhaust or vent ports that discharge vapor, soot, dust, or debris.

Install the indoor unit, outdoor unit, power supply cable, transmission cable and remote control cable at least 40 in (1 m) away from a television or radio. The purpose of this is to prevent TV reception interference or radio noise. (Even if they are installed more than 40 in (1 m) apart, you could still receive noise under some signal conditions.)

Keep the length of the piping of the indoor and outdoor units within the allowable range.

For maintenance purposes, do not bury the piping.

### 3.2. Drain processing

#### CAUTION

Perform drain work in accordance with this Manual, and ensure that the drain water is properly drained. If the drain work is not carried out correctly, water may drip down from the unit, wetting the furniture.

When the outdoor temperature is 32 °F (0 °C) or less, do not use the accessory drain pipe and drain cap. If the drain pipe and drain cap are used, the drain water in the pipe may freeze in extremely cold weather.

- If you are installing the drain pipe and drain caps, please provide a working space under the base of the outdoor unit.
- As the drain water flows out of the outdoor unit during heating operation, install the drain pipe and connect it to a commercial 5/8 in (16 mm) hose.
- When installing the drain pipe, plug all the holes other than the drain pipe mounting hole in the bottom of the outdoor unit with putty so there is no water leakage.

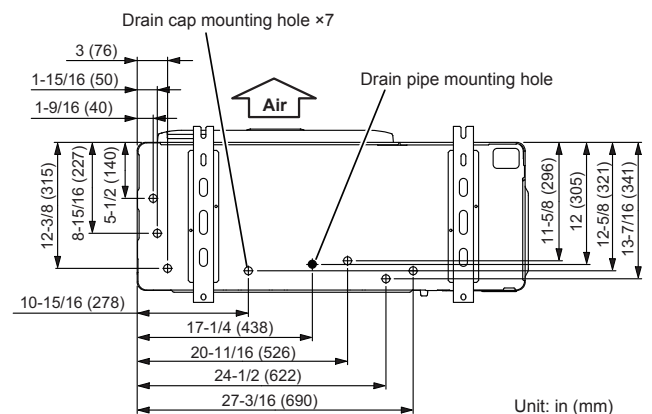
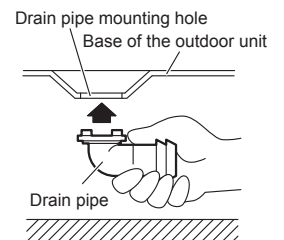

Unit: in (mm)

### 3.3. Installation dimensions

#### CAUTION

Provide sufficient installation space, such as transportation route, maintenance space, ventilation space, refrigerant piping space, and passageways.

Pay attention to the specifications of the installation space as shown in the figure. If the unit is not installed according to specifications, it may cause short circuit or poor performance. The unit may be prone to lapse into non-operation due to high pressure protection.

When there is a wall in front of the unit, provide a space of 20 in (500 mm) or more as maintenance space.

When there is a wall at the right side of the unit, provide a space of 2 in (25 mm) or more as maintenance space.

An outdoor temperature of 95 °F (DB) (35 °C (DB)) in air-conditioned operation is assumed for the installation space in this item. If the outdoor temperature exceeds 95 °F (DB) (35 °C (DB)) and the outdoor unit is operating at a load exceeding its rated ability, provide a larger inlet space.

If you are installing more outdoor units than indicated here, please ensure sufficient space or consult your distributing agent as it may affect the performance due to short circuit and other problems.

Consider the transportation route, installation space, maintenance space, and access, and install the unit in a location with sufficient space for the refrigerant piping.

Observe the installation space specifications that are shown in the figures. Keep the same space at rear air intake. Provide the same space for the air intake at the rear of the outdoor unit. If the installation is not performed according to the specifications, it could cause a short circuit and result in a lack of operating performance. As a result, the outdoor unit might easily be stopped by high-pressure protection.

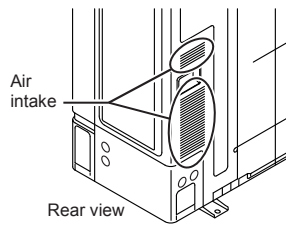

Installation methods not shown in the following examples are not recommended. Performance may drop significantly.

#### 3.3.1. Single outdoor unit installation

When the upward area is open Unit: in (mm)

(1) Obstacles at rear only

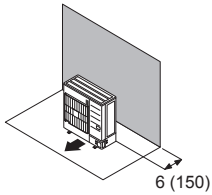

(2) Obstacles at rear and sides only

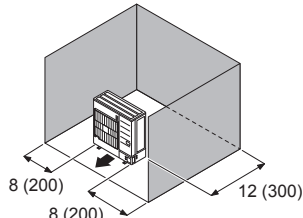

(3) Obstacles at front only

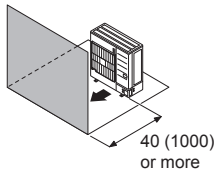

(4) Obstacles at front and rear only

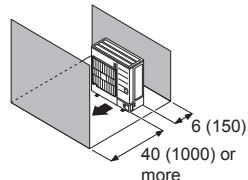

When an obstruction is present also in the upward area Unit: in (mm)

(1) Obstacles at rear and above only

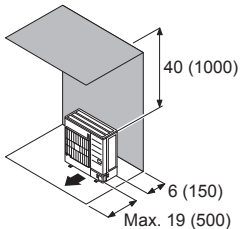

(2) Obstacles at rear, sides, and above only

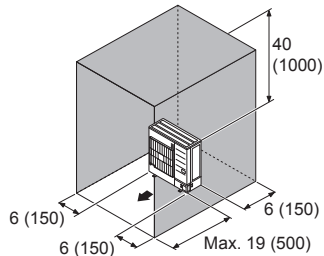

#### 3.3.2. Multiple outdoor unit installation

- Provide at least 1 in (25 mm) of space between the outdoor units if multiple units are installed.
  - When routing the piping from the side of an outdoor unit, provide space for the piping.
  - No more than 3 units must be installed side by side.
- When 3 units or more are arranged in a line, provide the space as shown in the following example when an obstruction is present also in the upward area.

When the upward area is open Unit: in (mm)

(1) Obstacles at rear only

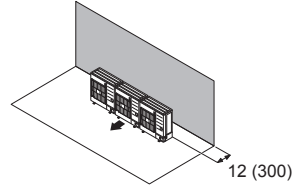

(2) Obstacles at front only

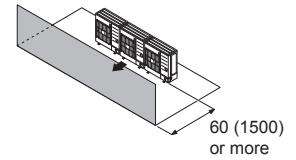

(3) Obstacles at front and rear only

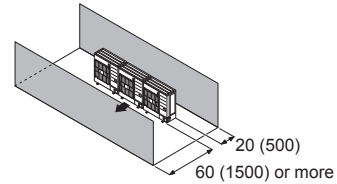

When an obstruction is present also in the upward area Unit: in (mm)

• Obstacles at rear and above only

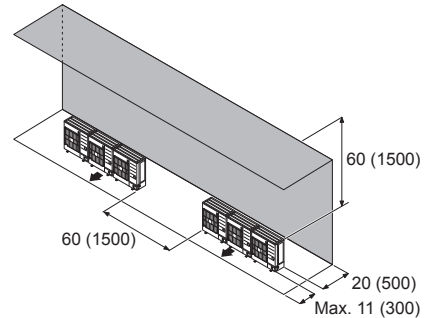

#### 3.3.3. Outdoor units installation in multi row

\* The following settings are not recommended in case of cooling by a low outside temperature. Unit: in (mm)

(1) Single parallel unit arrangement

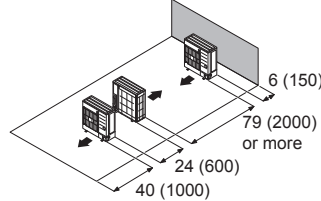

(2) Multiple parallel unit arrangement

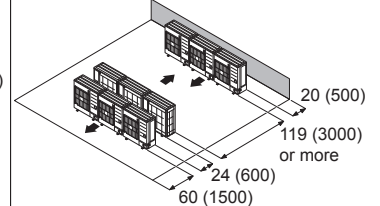

### 3.4. Transporting the unit

#### WARNING

Do not touch the fins. Otherwise, personal injury could result.

#### CAUTION

When carrying the unit, hold the handles on the right and left sides and be careful. If the outdoor unit is carried from the bottom, hands or fingers may be pinched.

Be sure to hold the handles on the sides of the unit. Otherwise, holding the suction grille on the sides of the unit may cause deformation.

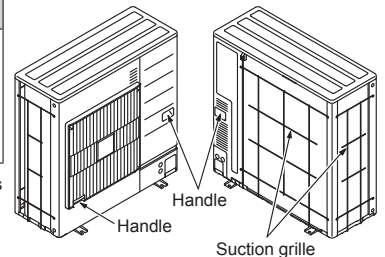

### 3.5. Installing the unit

- Please install the outdoor unit without slant. (within 3 degrees )
- Install 4 anchor bolts at the locations indicated with arrows in the figure.
- To reduce vibration, do not install the unit directly on the ground. Install it on a secure base (such as concrete blocks).
- The foundation shall support the legs of the unit and have a width of 2 in (50 mm) or more.
- Depending on the installation conditions, the outdoor unit may spread its vibration during operation, which may cause noise and vibration. Therefore, attach damping materials (such as damping pads) to the outdoor unit during installation.
- Install the foundation, making sure that there is enough space for installing the connection pipes.
- Secure the unit to a solid block using foundation bolts. (Use 4 sets of commercially available M10 bolts, nuts, and washers.)
- The bolts should protrude 13/16 in (20 mm). (Refer to the figure.)
- If overturning prevention is required, purchase the necessary commercially available items.

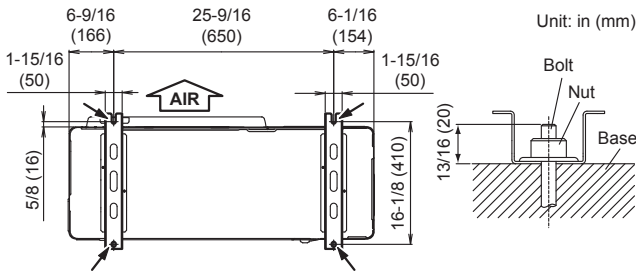

- Do not install directly on the ground, this may result in equipment failure.
- Provide ample space for ice buildup from condensate between the bottom of the unit and the flat surface on which it is mounted. Otherwise, there is risk that the drainage water will freeze between the device and the surface, disabling drainage.

**CAUTION**

If the unit is installed in a region that is exposed to high winds, freezing conditions, freezing rain, snow fall or heavy snow accumulation, take appropriate measures to protect it from those elements.

To ensure stable operation, the outdoor unit must be installed on a raised stand or rack, at or above the anticipated snow depth for the region. The installation of snow hoods and drift prevention fencing is recommended when blowing and drifting snow is common to the region.

## 4. SYSTEM CONFIGURATION

### 4.1. System configuration

**CAUTION**

Always keep to the limit on the total amount of refrigerant. Exceeding the limit on the total amount of refrigerant when charging will lead to malfunction.

- Between outdoor unit and the farthest indoor unit  
 $a + d \leq 164 \text{ ft (50 m)}$ ,  $a + h \leq 164 \text{ ft (50 m)}$
- Between the first separation tube and the farthest indoor unit  
 $d \leq 131 \text{ ft (40 m)}$ ,  $h \leq 131 \text{ ft (40 m)}$
- Between the nearest indoor unit and the outdoor unit  
 $a + b + e \geq 16 \text{ ft (5 m)}$ ,  $a + c + i \geq 16 \text{ ft (5 m)}$
- Between outdoor unit and the first separation tube  
 $a \geq 9 \text{ ft (3 m)}$
- Difference in height between outdoor units and indoor units (H1)  
98 ft (30 m) or less: Outdoor unit is higher than indoor unit  
98 ft (30 m) or less: Outdoor unit is lower than indoor unit
- Difference in height between indoor units and indoor units  
 $H2 \leq 49 \text{ ft (15 m)}$ ,  $H3 \leq 49 \text{ ft (15 m)}$
- Maximum total equivalent pipe length  
 $a + d + e + f + g + h + i + j + k \leq 262 \text{ ft (80 m)}$
- Total refrigerant amount  $\leq 15 \text{ lb (6.83 kg)}$

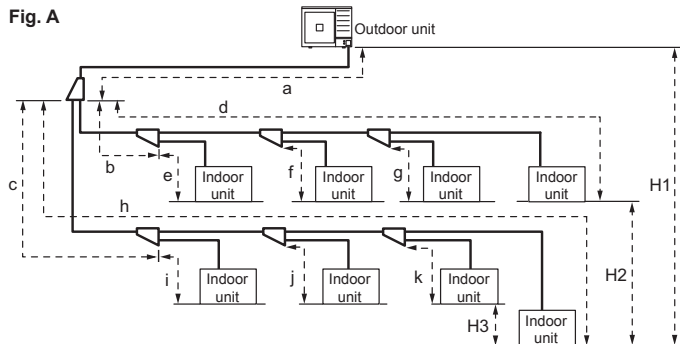

### 4.2. Pipe selection

**CAUTION**

This unit is designed specifically for use with the R410A refrigerant.

Pipes for R407C or R22 may not be used with this unit.

Do not use existing pipes.

Improper pipe selection will degrade performance.

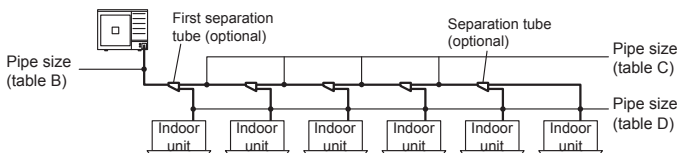

**Table. A (Wall thickness and pipe material for each diameter)**

Outside Diameter	in (mm)	1/4 (6.35)	3/8 (9.52)	1/2 (12.70)	5/8 (15.88)
Wall Thickness *2	in (mm)	0.032 (0.8)	0.032 (0.8)	0.032 (0.8)	0.039 (1.0)
Material	COPPER *1 JIS H3300 C1220T-O or equivalent				

Please select the pipe size in accordance with local rules.

\*1: Allowable tensile stress  $\geq 33 \text{ N/mm}$

\*2: Endurance pressure of the pipes 609 psi (4.2 MPa)

**Table. B (Diameter of piping used between outdoor unit and first separation tubes or headers)**

MODEL	Outdoor unit cooling capacity [Btu]	Diameter of piping [in (mm)]	
		Liquid pipe	Gas pipe
AOU36RLAVS	36,000	3/8 (9.52)	5/8 (15.88)
AOU48RLAVS	48,000	3/8 (9.52)	5/8 (15.88)

**Table. C (Diameter of piping used between separation tubes)**

Outside diameter [in (mm)]		Separation tube *3	Header *3
Liquid pipe	Gas pipe		
3/8 (9.52)	5/8 (15.88)	UTP-AX054A	UTR-H0906L UTR-H0908L

\*3: For the installation method, please refer to the installation manuals for indoor unit, separation tubes or headers.

Use a standard separation tube for pipe branching. Do not use a T tube as it does not separate the refrigerant evenly.

**Table. D (Diameter of piping used between separation tube and indoor unit)**

Cooling capacity of indoor unit [Btu]	Outside diameter [in (mm)]	
	Liquid pipe	Gas pipe
7,500 / 9,500 / 12,000 / 14,000	1/4 (6.35)	1/2 (12.70)
18,000 / 24,000 / 30,000	3/8 (9.52)	5/8 (15.88)
36,000 / 48,000 / 60,000 *4		3/4 (19.05)

\*4: If pipe diameter Table D > Table C, using of pipe size from Table C is preferable. (Use reducer to change the diameter of connection pipe.)

### When one indoor unit is connected to the outdoor unit.

- Please use a reducer (locally purchased) to match the piping diameter of the outdoor unit to the indoor unit valve. Attach the reducer to the indoor unit valve.
- For the valve size of the indoor unit, refer to the installation manual of the indoor unit or Design and Technical Manual.

#### Connection example



### 4.3. Protection of pipes

Location	Working period	Protection method
Outdoor	1 month or more	Pinch pipes
	Less than 1 month	Pinch or tape pipes
Indoor	—	Pinch or tape pipes

- Protect the pipes to prevent the entry of moisture and dust.
- Especially pay attention when passing the pipes through a hole or connecting the end of a pipe to the outdoor unit.

## 5. PIPE INSTALLATION

### 5.1. Brazing

**CAUTION**

If air or another type of refrigerant enters the refrigeration cycle, the internal pressure in the refrigeration cycle will become abnormally high and prevent the unit from exerting its full performance.

Apply nitrogen gas while brazing the pipes.  
Nitrogen gas pressure: 2.9 psi (0.02 MPa)  
(= pressure felt sufficiently on the back of your hand)

If a pipe is brazed without applying nitrogen gas, it will create an oxidation film. This can degrade performance or damage the parts in the unit (such as the compressor or valves).

Do not use flux to braze pipes. If the flux is the chlorine type, it will cause the pipes to corrode. In addition, if the flux contains fluoride, it will affect the refrigerant piping system due to deterioration of refrigerant oil.

For brazing material, use phosphor copper that does not require flux.

## 5.2. Indoor unit pipe connections

### CAUTION

For details, refer to the Installation Instruction Sheet of each part.

### Separation tube

**A:**  
Outdoor unit or Refrigerant branch kit

**B:**  
Indoor unit or Refrigerant branch kit

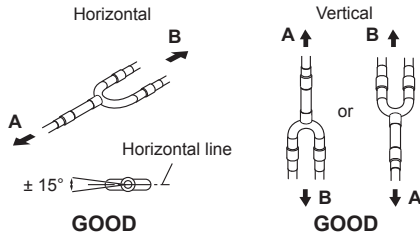

**PROHIBITED**

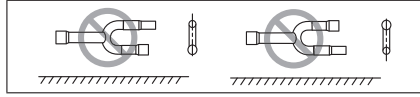

### Header

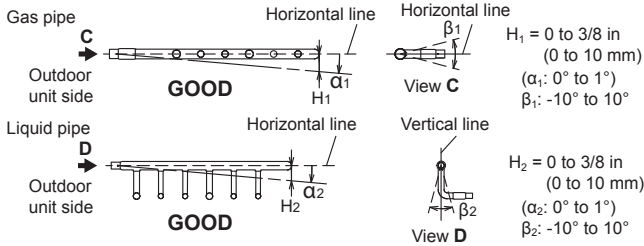

**PROHIBITED**

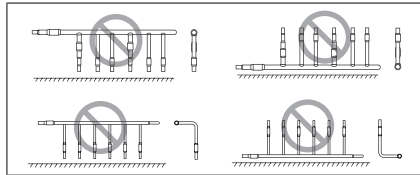

### CAUTION

Do not connect a separation tube after a header.

Leave the distance 2 ft (0.5 m) or more for straight part to branch tube and header.

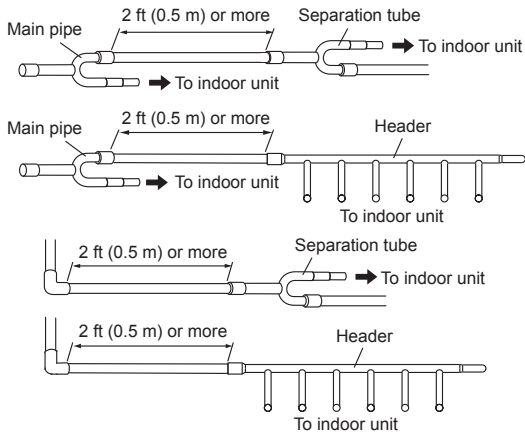

## 5.3. Opening the knockout hole

### CAUTION

Be careful not to deform or scratch the panel while opening the knockout holes.

To protect the piping insulation after opening a knockout hole, remove any burrs from the edge of the hole. It is recommended to apply rust prevention paint to the edge of the hole.

- Pipes can be connected from 4 directions, front, lateral side, rear side and bottom. (Fig. A)
- When connecting at the bottom, remove the service panel and piping cover on the front of the outdoor unit, and open the knockout hole provided at the bottom corner of the piping outlet.
- It can be installed as shown on "Fig. B" cutting out the 2 slits as indicated on "Fig. C". (When cutting slits, use a steel saw.)

Fig. A

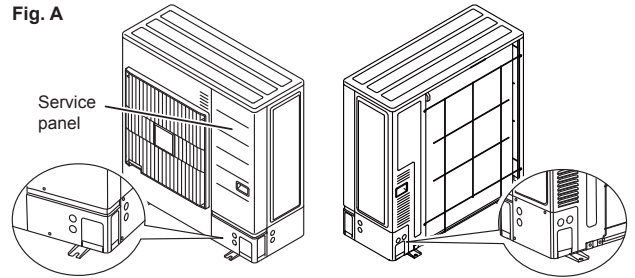

Fig. B

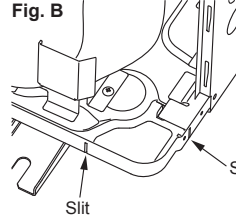
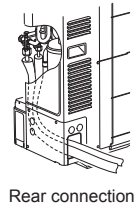
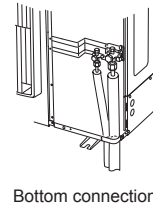
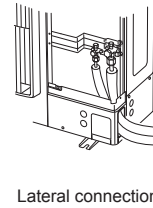
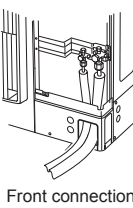
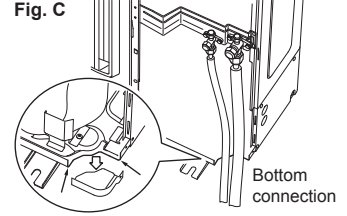

Fig. C



## 5.4. Pipe connection

### CAUTION

Do not use mineral oil on a flared part. Prevent mineral oil from getting into the system as this would reduce the lifetime of the units.

While brazing the pipes, be sure to blow dry nitrogen gas through them.

The maximum lengths of this product are shown in the table. If the units are further apart than this, correct operation cannot be guaranteed.

### 5.4.1. Flaring

Use special pipe cutter and flare tool exclusive for R410A.

- (1) Cut the connection pipe to the necessary length with a pipe cutter.
- (2) Hold the pipe downward so that the cuttings will not enter the pipe and remove any burrs.
- (3) Insert the flare nut (always use the flare nut attached to the indoor and outdoor units respectively) onto the pipe and perform the flare processing with a flare tool. Leakage of refrigerant may result if other flare nuts are used.
- (4) Protect the pipes by pinching them or with tape to prevent dust, dirt, or water from entering the pipes.

Check if [L] is flared uniformly and is not cracked or scratched.

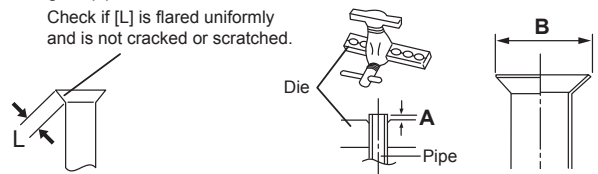

Pipe outside diameter [in (mm)]	Dimension A [in (mm)]	Dimension B $\begin{matrix} 0 \\ -0.015 (-0.4) \end{matrix}$ [in (mm)]
	Flare tool for R410A, clutch type	
1/4 (6.35)	0 to 0.020 (0 to 0.5)	3/8 (9.1)
3/8 (9.52)		1/2 (13.2)
1/2 (12.70)		5/8 (16.6)
5/8 (15.88)		3/4 (19.7)
3/4 (19.05)		15/16 (24.0)

When using conventional (R22) flare tools to flare R410A pipes, the dimension A should be approximately 0.020 in (0.5 mm) more than indicated in the table (for flaring with R410A flare tools) to achieve the specified flaring. Use a thickness gauge to measure the dimension A. It is recommended that a R410A flaring tool is used.

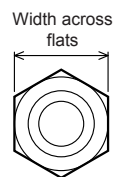

Pipe outside diameter [in (mm)]	Width across flats of Flare nut [in (mm)]
1/4 (6.35)	11/16 (17)
3/8 (9.52)	7/8 (22)
1/2 (12.70)	1 (26)
5/8 (15.88)	1-1/8 (29)
3/4 (19.05)	1-7/16 (36)

### 5.4.2. Bending pipes

#### CAUTION

To prevent breaking of the pipe, avoid sharp bends. Bend the pipe with a radius of curvature of 4 in (100 mm) or more.

If the pipe is bent repeatedly at the same place, it will break.

- If pipes are shaped by hand, be careful not to collapse them.
- Do not bend the pipes at an angle of more than 90°.
- When pipes are repeatedly bent or stretched, the material will harden, making it difficult to bend or stretch them any more.
- Do not bend or stretch the pipes more than 3 times.

#### Pipe connection

#### CAUTION

Be sure to install the pipe against the port on the indoor unit and the outdoor unit correctly. If the centering is improper, the flare nut cannot be tightened smoothly. If the flare nut is forced to turn, the threads will be damaged.

Do not remove the flare nut from the outdoor unit pipe until immediately before connecting the connection pipe.

After installing the piping, make sure that the connection pipes do not touch the compressor or outer panel. If the pipes touch the compressor or outer panel, they will vibrate and produce noise.

- (1) Detach the caps and plugs from the pipes.
- (2) Center the pipe against the port on the outdoor unit, and then turn the flare nut by hand.
- (3) Tighten the flare nut of the connection pipe at the outdoor unit valve connector.
- (4) After tightening the flare nut by hand, use a torque wrench to fully tighten it.

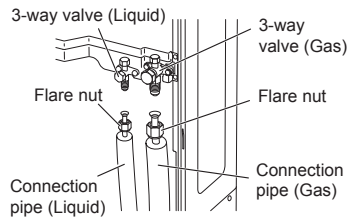

#### CAUTION

Hold the torque wrench at its grip, keeping it in a right angle with the pipe, in order to tighten the flare nut correctly.

Outer panel may be distorted if fastened only with a wrench. Be sure to fix the elementary part with a holding wrench (spanner) and fasten with a torque wrench (refer to below diagram). Do not apply force to the blank cap of the valve or hang a wrench, etc., on the cap. If blank cap is broken, it may cause leakage of refrigerant.

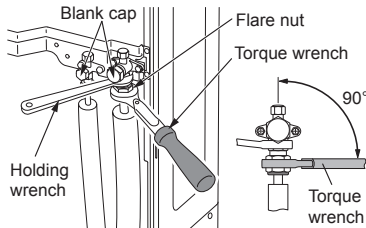

Flare nut [in (mm)]	Tightening torque [lbf·ft (N·m)]
1/4 (6.35) dia.	11.8 to 13.3 (16 to 18)
3/8 (9.52) dia.	23.6 to 31.0 (32 to 42)
1/2 (12.70) dia.	36.1 to 45.0 (49 to 61)
5/8 (15.88) dia.	46.5 to 55.3 (63 to 75)
3/4 (19.05) dia.	66.4 to 81.1 (90 to 110)

### 5.4.3. Handling precautions for the valves

- Mounted part of Blank cap is sealed for protection.
- Fasten blank cap tightly after opening valves.

#### Operating the valves

- Use a hexagon wrench (size 3/16 in (4 mm)).

#### Opening:

- (1) Insert the hexagon wrench into the valve shaft, and turn it counterclockwise.
- (2) Stop turning when the valve shaft can no longer be turned. (Open position)

#### Closing:

- (1) Insert the hexagon wrench into the valve shaft, and turn it clockwise.
- (2) Stop turning when the valve shaft can no longer be turned. (Closed position)

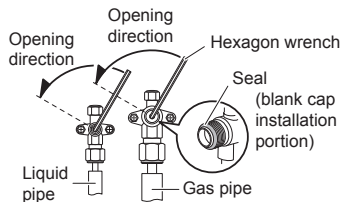

## 6. ELECTRICAL WIRING

### 6.1. The precautions of electrical wiring

#### WARNING

Wiring connections must be performed by a qualified person in accordance with specifications.

The rated supply of this product is 60 Hz, 208/230 V of 1-phase. Use a voltage within the range of 187-253 V

Make sure to perform earthing (grounding) work. Improper earthing (grounding) work can cause electric shocks.

Before connecting the cables, make sure the power supply is OFF.

We suggest installing GFEB breakers or follow local electrical code. When installing this system, install using ground fault equipment breakers (GFEB) to reduce the risk of leaking current which may result in electric shock or potential fire.

Be sure to install a breaker of the specified capacity. When selecting breaker, please comply with the laws and the regulations of each country. One breaker must be installed on the power supply of the outdoor unit. Wrong selection and setup of the breaker will cause electric shock or fire.

Do not connect AC power supply to the transmission line terminal board. Improper wiring can damage the entire system.

Connect the connector cord securely to the terminal. Faulty installation can cause a fire.

Do not modify power cable, use extension cable or branch wiring. Improper use may cause electric shock or fire by poor connection, insufficient insulation or over current.

Make sure to secure the insulation portion of the connector cable with the cord clamp. A damaged insulation can cause a short circuit.

Never install a power factor improvement condenser. Instead of improving the power factor, the condenser may overheat.

**CAUTION - Risk of Electric Shock**  
Before servicing the unit, turn the power supply switch OFF. Then, do not touch electric parts for 20 minutes due to the risk of electric shock.

Always use a separate power supply line protected by a circuit breaker operating on all cables with a distance between contact of 1/8 in (3 mm) for this unit.

Use ring terminals and tighten the terminal screws to the specified torques, otherwise, abnormal overheating may be occurred and possibly cause serious damage inside the unit.

Securely install the electrical box cover on the unit. An improperly installed service panel can cause serious accidents such as electric shock or fire through exposure to dust or water.

If the supply cable is damaged, it must be replaced by the manufacturer, its service agent or similarly qualified persons in order to avoid a hazard.

#### CAUTION

The primary power supply capacity is for the air conditioner itself, and does not include the concurrent use of other devices.

Connect the power cables in positive phase sequence. If there is a missing phase connection, the unit will not operate normally.

Do not crossover power supply wiring for the outdoor unit.

If the electrical power is inadequate, contact your electric power company.

Install a breaker in a location that is not exposed to high temperatures. If the temperature surrounding the breaker is too high, the amperage at which the breaker cuts out may decrease.

This system uses an inverter, which means that when used with a ground fault breaker you must use breakers that can handle harmonics such as a (GFEB) Ground Fault Equipment Breaker (100 mA or greater) in order to prevent malfunctioning of ground fault device.

When the electrical switchboard is installed outdoors, place it under lock and key so that it is not easily accessible.

Never bundle the power supply cable and transmission cable, remote control cable together. Separate these cable by 2 in (50 mm) or more. Bundling these cables together will cause miss operation or breakdown.

Always keep to the maximum length of the transmission cable. Exceeding the maximum length may lead to erroneous operation.

The static electricity that is charged to the human body can damage the control PC board when handling the control PC board for address setting, etc.

Please keep caution to the following points.

Provide the earthing (grounding) of Indoor unit, Outdoor unit and Option equipment. Cut off the power supply (breaker).

Touch the metal section (such as the unpainted control box section) of the indoor or outdoor unit for more than 10 seconds. Discharge the static electricity in your body. Never touch the component terminal or pattern on the PC board.



## 6.2. Knockout hole

### CAUTION

Be careful not to deform or scratch the panel while opening the knockout holes.

After opening the knockout hole, remove the burr on the edges to prevent snapping of cables.

It is recommended to apply rust proof paint on the edges to prevent rust.

Knockout holes are provided for wiring.

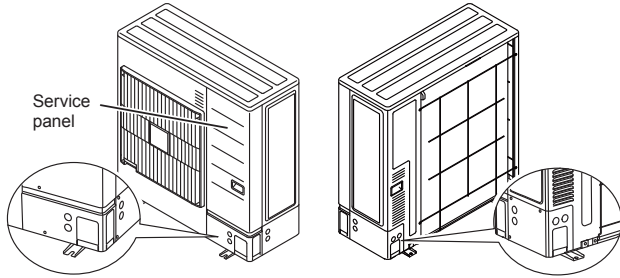

Knockout holes are provided 2 each in the same size in front, lateral and rear sides.

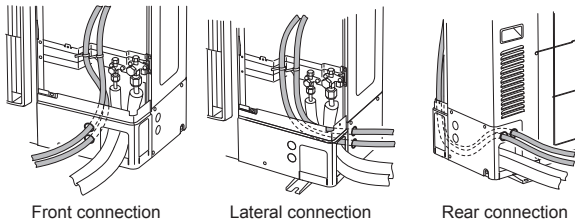

## 6.3. Selecting power supply cable and breaker

### CAUTION

Obtain the distribution network operator's agreement about the power capacity of the power supply system and specification of the cable, when you connect the outdoor unit with the power supply.

Regulation of wire size and circuit breaker differs from each locality, please refer in accordance with local rules.

- Select the power cable type and size in accordance with relevant local and national regulations.
- Make sure the specifications for local wiring power cable and branch wiring are in compliance with local code.
- Select the correct cable type and size according to the country or region's regulations.
- Use copper conductors only.
- Max. wire length: Set a length so that the voltage drop is less than 2%. Increase the wire diameter when the wire length is longer.

Selecting power supply cable and breaker when connecting single outdoor unit. Refer to the table for the breaker specifications of each installation condition.

Use	Size	Remarks
Power supply cable	8 AWG (8.4 mm <sup>2</sup> )	2 cable + Ground, ~, 208/230 V

Model	MCA	MAX. CKT. BKR	GFEB
AOU36RLAVS	33 A	40 A	30 mA
AOU48RLAVS			0.1 sec or less

MCA: Minimum Circuit Amp.

MAX. CKT. BKR: Maximum Circuit Breaker

- Select the appropriate breaker of the described specification according to the national or regional standards.
- Select the breaker that enough load current can pass through it.

### In case of connected outdoor unit

Breaker 1: Ground Fault Equipment Breaker (GFEB)  
Breaker 2: Maximum Circuit Breaker (MAX. CKT. BKR)

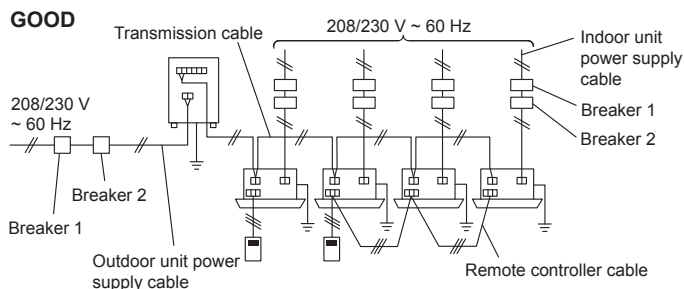

## 6.4. Transmission line

### CAUTION

Caution when wiring cable:

When stripping off the coating of lead wire, always use the exclusive tool such as a wire stripper. If there is no exclusive tool available necessarily, carefully strip the coating by a cutter etc. so that the conductive wire is not damaged. If it is damaged, it may lead to an open circuit and a communication error.

Pay attention to the following points while attaching wires on the terminal board.

- Do not attach 2 wires on one side.
- Do not twist wires.
- Do not cross the wires.
- Do not shorted at edge at root.

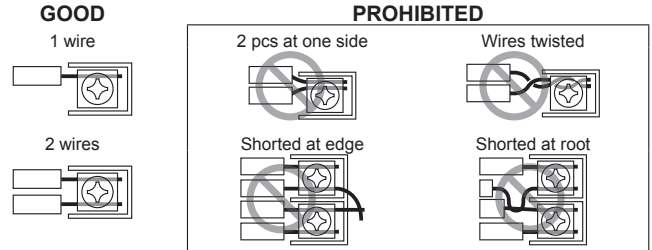

### 6.4.1. Transmission wiring specifications

Follow the specifications below for the transmission cable.

Use	Size	Wire type	Remarks
Transmission cable	22 AWG (0.33 mm <sup>2</sup> )	LEVEL 4 (NEMA) non-polar 2 core, twisted, shielded pair, solid core, diameter 0.026 in (0.65 mm)	LONWORKS® compatible cable

Twisted pair with shielded type.

Use the shielded wire specified and always ground it both end.

### 6.4.2. Wiring rules

- (1) Total length of transmission cable  
Total transmission line length: MAX 11,811 ft (3,600 m)  
 $EF + EG + GH + HJ + HK + KL < 11,811 \text{ ft (3,600 m)}$  (Fig. 2)  
In the following cases, Signal Amplifier is required.
  - 1) When the total length of the transmission line exceeded 500 m.  
 $AB + BC + BD > 1,640 \text{ ft (500 m)}$  (Fig. 1)
  - 2) When the total number of units\* is over 64.
  - 3) Transmission line length between each unit\*  $\geq 1,312 \text{ ft (400 m)}$
- (2) Length of transmission cable between 1 network segment (NS)  
 $EF + EG + GH + HJ + HK \leq 1,640 \text{ ft (500 m)}$  (Fig. 2)  
 $KL \leq 1,312 \text{ ft (400 m)}$  (Fig. 2)

Unit\* means indoor unit, outdoor unit, Touch Panel Controller and System Controller, Signal Amplifier, single split adaptor, Network Converter etc.

Fig. 1

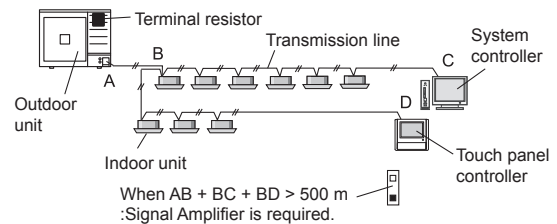
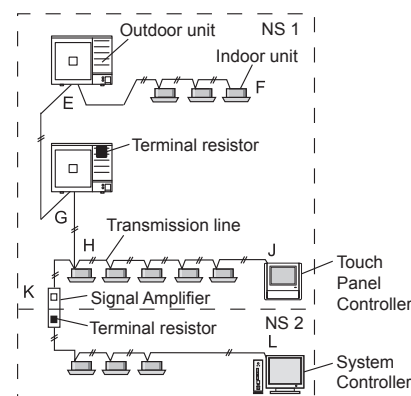

Fig. 2



### NOTES:

Do not use loop wiring. This may lead to parts damage and erroneous operation.



### 6.4.3. Enabling/Disabling automatic address setting

You can enable/disable automatic address setting for the indoor unit and the signal amplifier.

To enable automatic address setting for the indoor unit, connect the indoor unit to outdoor units under the same refrigerant system.

#### Example: Disable Automatic Address setting

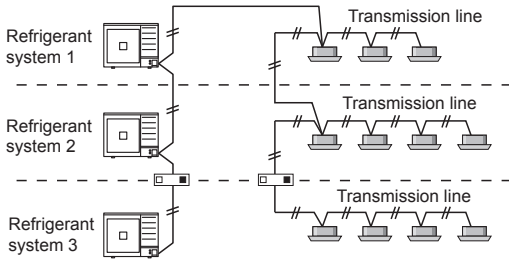

#### Example: Enable Automatic Address setting

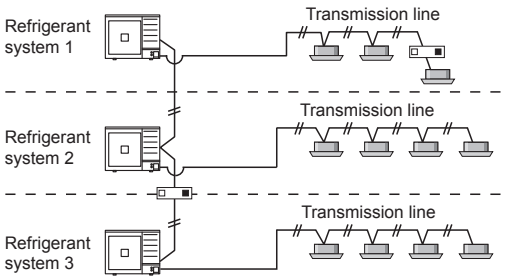

## 6.5. Wiring method

### 6.5.1. Connection diagrams

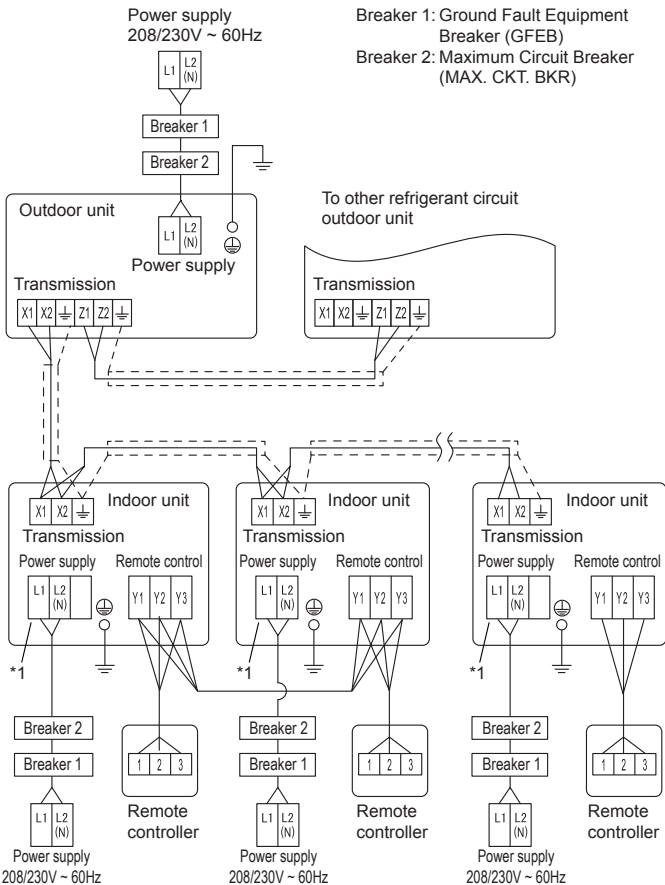

\*1: The number of power supply terminals is different depending on the indoor unit model. For the wiring, refer to the indoor unit installation manual.

• There are two types of remote controller: the 2-wire type and the 3-wire type. For details, see the relevant remote controller installation manual. (When connecting the 2-wire type remote controller, Y3 is not used.)

The wiring example for outdoor and indoor units is shown in figure.

### 6.5.2. Wiring procedure

- Remove the service panel. And connect the cable to the terminal in accordance with the terminal name plate.
- Use a ring terminal to connect the electric cables to the power supply terminal board.
- Keep the earth cable longer than the other cables.
- After connecting the electric cable, secure them with a cable clamp.
- Connect the cable without applying excessive tension.
- Use the specified cable type and connect the cable securely.

Secure with a cable clamp as shown in the figure below.

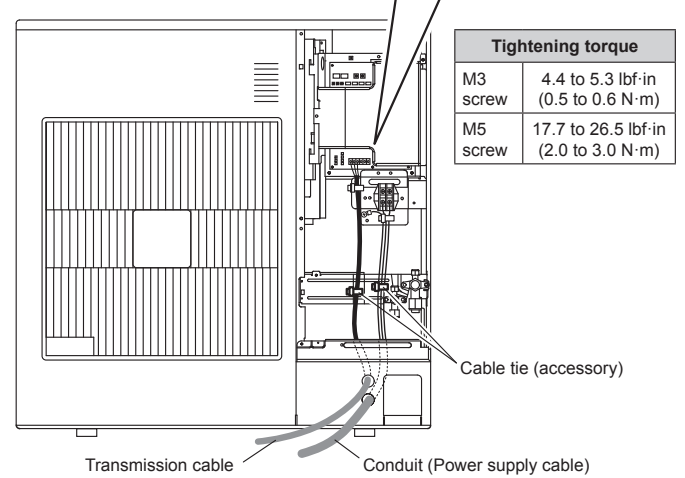
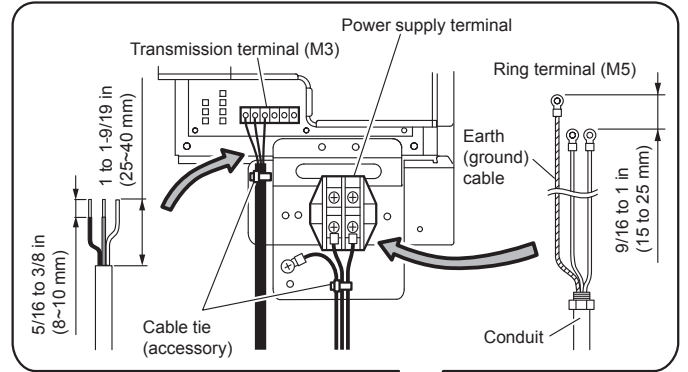

#### How to connect wiring to the terminal

##### Caution when wiring cable

- (1) Use ring terminals with insulating sleeves as shown in the figure to connect to the terminal block.
- (2) Securely clamp the ring terminals to the cables using an appropriate tool so that the cables do not come loose.
- (3) Use the specified cables, connect them securely, and fasten them so that there is no stress placed on the terminals.
- (4) Use an appropriate screwdriver to tighten the terminal screws. Do not use a screwdriver that is too small, otherwise, the screw heads may be damaged and prevent the screws from being properly tightened.
- (5) Do not tighten the terminal screws too much, otherwise, the screws may break.
- (6) See the table below for the terminal screw tightening torques.

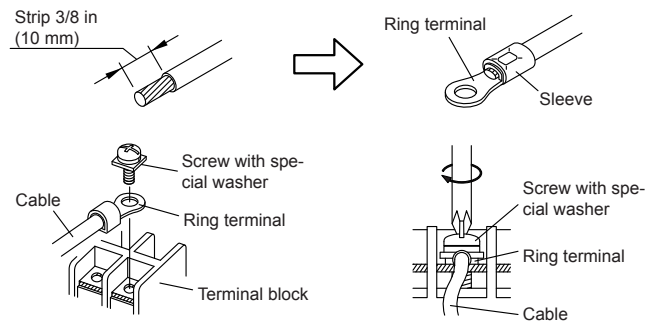

### Shielding the transmission cable

Connect both ends of the shielded wire of the transmission cable to the earth (ground) terminal of the equipment or to the earth (ground) screw near the terminal. Be sure to use one side of a twisted-pair cable when using transmission cable with 2 sets of twisted-pair cables.

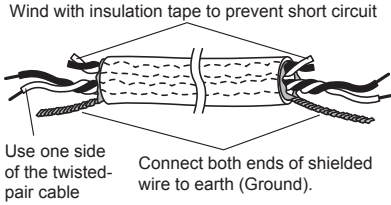

### Installation method of conduit plate

Please fix the conduit plate (accessory) as shown in the figure below.

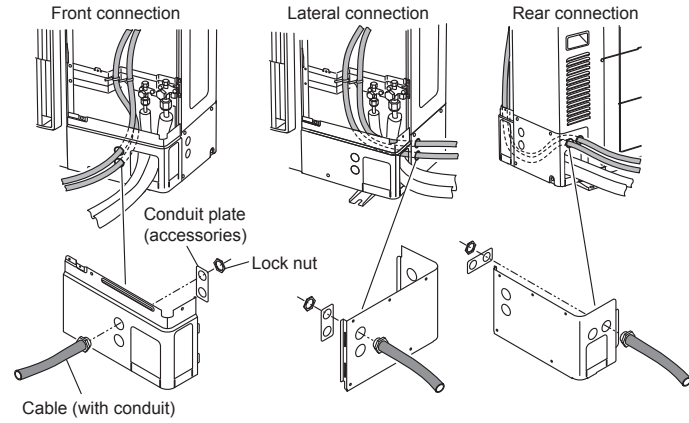

Fix the conduit with the supporters as shown below.

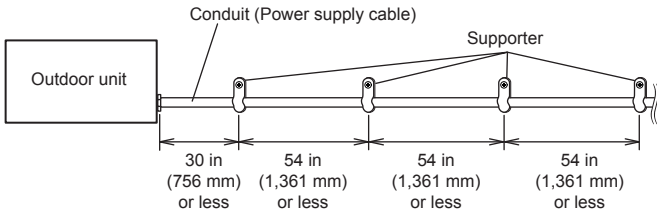

## 6.6. External input and external output

### 6.6.1. Terminal position

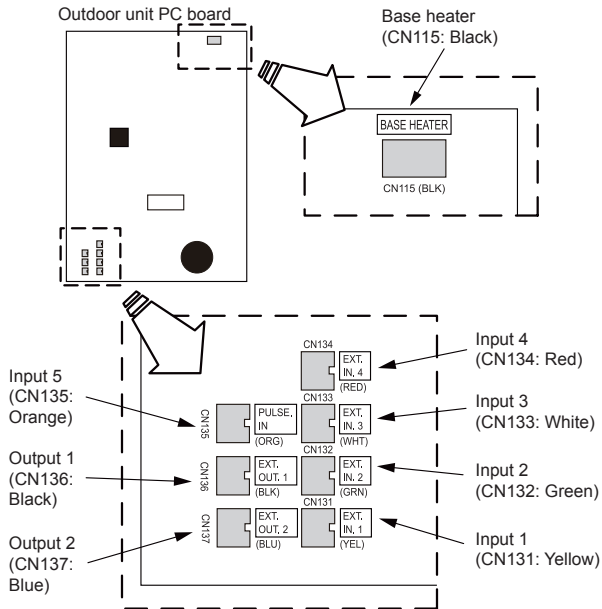

Do not bundle the cable for base heater with other cables.

### 6.6.2. External input terminal

Setting to low noise mode, cooling priority/heating priority selection, outdoor unit operation peak control setting, emergency/batch stop and electricity meter pulse are possible from the outside.

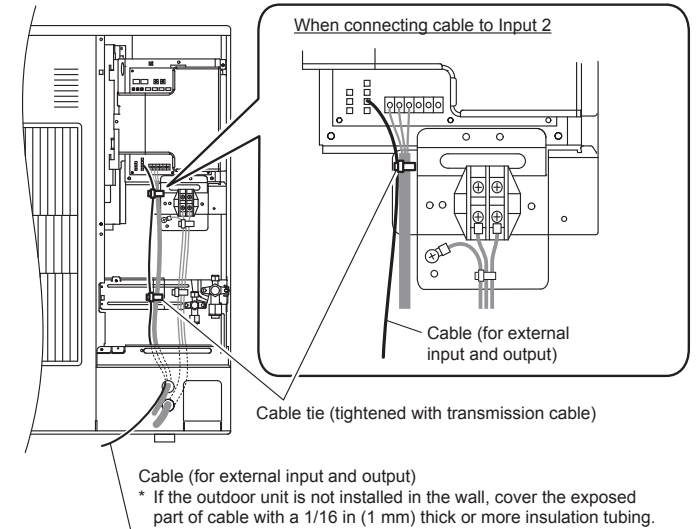

### Wiring method and specifications

- \* A twisted pair cable (22 AWG (0.33 mm<sup>2</sup>)) should be used. Maximum length of cable is 492 ft (150 m).
- \* Use an external input and output cable with appropriate external dimension, depending on the number of cables to be installed
- \* For each input, pin No. 1 is of positive polarity and pin No. 2 is of ground level.

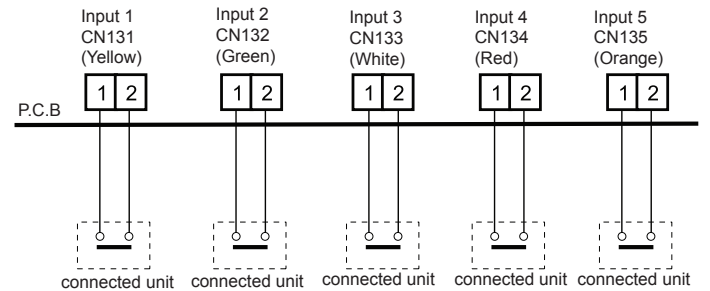

### Operation behavior

Each input terminal works as follows.

Connector	Input signal	Status
Input 1 CN131 (Yellow)	OFF	Normal operation
	ON	Low noise mode operation
Input 2 CN132 (Green) *1	OFF	Cooling priority
	ON	Heating priority
Input 3 CN133 (White)	OFF	Normal operation
	ON	Outdoor unit operation peak control
Input 4 CN134 (Red)	OFF	Normal operation
	ON	Batch stop or Emergency stop operation *2, *3
Input 5 CN135 (Orange) *4	No pulse	No information from electricity meter
	Pulse	Power usage information from electricity meter

The operations of each input terminal and the selection of function are set with the push button on the PC board of outdoor unit. About the setting, please refer to "7. 4. Push button setting".

### NOTES:

- \*1: The "external input priority mode" must be set by pressing push button on PC board of outdoor unit. (Refer to "7. FIELD SETTING".)
- \*2: Batch stop or Emergency stop pattern can be selected by outdoor unit PC board push button. (Refer to "7. FIELD SETTING".)
- \*3: The emergency stop function mounted in the J-II does not guarantee the regulations of each country. For this reason, sufficient checking is necessary regarding use. Especially, since the fact that the equipment may not be emergency-stopped in the case of breaking of the wiring to the external input terminals and communication line, communication error due to noise, VRF external input circuit trouble, etc. must be considered, the provision of double measures that add direct interruption of the power supply by switch, etc. is recommended as a precaution.
- \*4: Pulse input to CN135 must be width 50 ms or more, and must be interval 50 ms or more.

### 6.6.3. External output terminal

You can detect the operation condition of outdoor unit and the abnormal situation of both indoor and outdoor unit.

Wiring method and specifications

#### Error status

This output indicates the outdoor unit and connected indoor unit's "Normal" or "Error" status.

#### Operation status

This output indicates the outdoor unit's "Operation" status.

Connector	Output voltage	Status
Output 1 CN136 (Black)	0 V	Normal
	DC 12-24 V *5	Error
Output 2 CN137 (Blue)	0 V	Stop
	DC 12-24 V *5	Operation

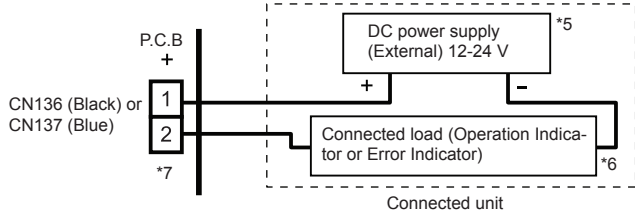

- \*5: Provide a DC 12 to 24 V power supply. Select a power supply capacity with an ample surplus for the connected load.
- \*6: The allowable current is 30 mA or less. Provide a load resistance such that the current becomes 30 mA or less.
- \*7: Polarity is [+] for pin 1 and [-] for pin 2. Connect correctly. Do not impress a voltage exceeding 24 V across pins 1-2.
- \* A twisted pair cable (22 AWG (0.33 mm<sup>2</sup>)) should be used. Maximum length of cable is 492 ft (150 m).
- \* Use an external input and output cable with appropriate external dimension, depending on the number of cables to be installed.

### 6.6.4. Base heater terminal

This is the output signal for base heater. Output signal ON, when the outdoor temperature goes down below 32°F (2°C), and signal OFF at the outdoor temperature 39°F (4°C).

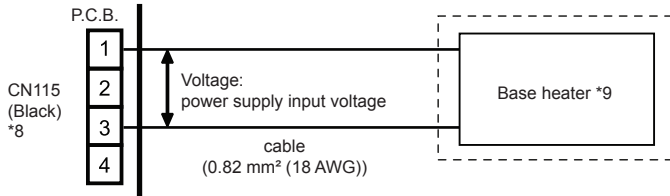

- \*8: Connect to pin 1 and pin 3. No connection pin 2 and pin 4.
- \*9: The allowable current is 1 A or less.

## 7. FIELD SETTING

### CAUTION

Discharge the static electricity from your body before setting up the DIP switches. Never touch the terminals or the patterns on the parts that are mounted on the PC board.

### 7.1. Field setting switches

Remove the service panel of the outdoor unit and the cover of the electrical component box to access the PC board of the outdoor unit. PC board switches for various settings and LED displays are shown in the figure.

### 7.2. DIP switch setting

#### 7.2.1. List of Settings

SET 5 must be set for the DIP switch. Configure the settings before turning on the power. Settings for SET 1, SET 2, SET 3 and SET 4 DIP switches are factory default ones. Do not change them.

DIP Switch	Function
SET 1	1-4 Forbidden
SET 2	1-4 Forbidden
SET 3	1-4 Forbidden
SET 4	1-4 Forbidden
SET 5	1-3 Forbidden
SET 5	4 Terminal resistor setting

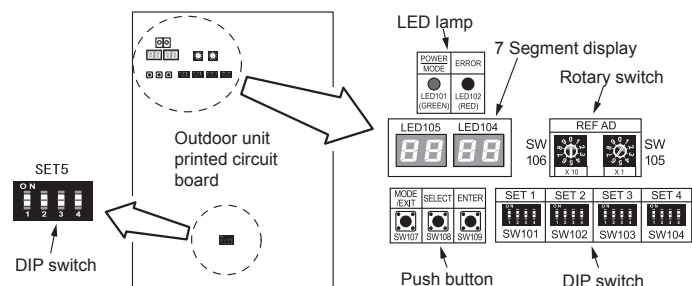

### 7.2.2. Terminal resistor setting

### CAUTION

Be sure to set the terminal resistor according to specifications. Set the terminal resistor for every network segment (NS).

If terminal resistor is set in multiple devices, the overall communication system may be damaged.  
If terminal resistor is not set in a device, abnormal communication may occur.

- Be sure to set 1 terminal resistor in a network segment. You can set the terminal resistor at the outdoor unit or signal amplifier.
- When setting the terminal resistor of a signal amplifier, refer to the installation manual of the signal amplifier.
- When setting multiple terminal resistors, take note of the following items.

- (1) How many network segments are there in a VRF system?
- (2) Where will you set the terminal resistors in a network segment? (Condition for 1 segment: Total number of outdoor and indoor units and signal amplifiers is less than 64, or the total length of the transmission cable is less than 500 m)
- (3) How many outdoor units are connected to 1 refrigerant system?

Configure the setting (DIP switch SET 5) of the terminal resistor of the outdoor units as shown below from conditions (1) to (3).

SET 5	Terminal resistor	Remarks
4		
OFF	Disable	—
ON	Enable	(Factory setting)

Figure: Terminal resistor setting

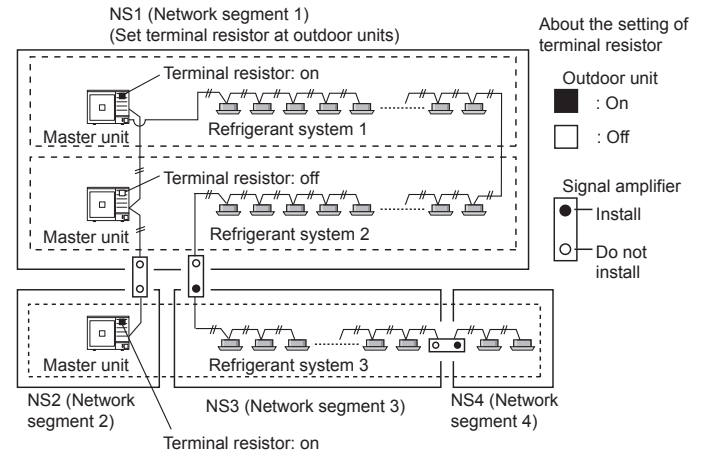

### 7.3. Rotary switch setting

The rotary switch (REF AD) sets the refrigerant circuit address of the outdoor unit. Configure the settings only on the master unit of a refrigerant system. If multiple refrigerant systems are connected, set the rotary switch (REF AD) as shown in the table below.

Refrigerant circuit address	Rotary Switch Setting		Setting	Setting range	Type of switch
	REF AD	REF AD			
0	0	0	Refrigerant circuit address	0-99	Setting example 63
1	0	1			
2	0	2			
.	.	.			
.	.	.			
98	9	8	Rotary Switch (REF AD × 1): Factory setting "0"		
99	9	9	Rotary Switch (REF AD × 10): Factory setting "0"		

### 7.4. Push button setting

Various functions can be set. Set when necessary. Perform settings after all indoor units have stopped operation.

Table A: List of Settings

No	Setting Item	7 segment display		Factory default		
		First 2 digits	Last 2 digits			
00	(Forbidden)	0	0	●		
	(Factory default)					
10	(Forbidden)	1	0	●		
	(Factory default)					
11	Normal mode	1	1	0	0	●
	Save energy mode			0	1	
	High power mode 1			0	2	
	High power mode 2			0	3	
	(Forbidden)			0	4	
Set this item when necessary.						

12	Heating capacity shift *1	Normal mode	1	2	0	0	●
		Save energy mode			0	1	
		High power mode 1			0	2	
		High power mode 2			0	3	
Set this item when necessary. (Forbidden)							
13	(Factory default)		1	3	0	0	●
14	(Forbidden)		1	4	0	0	●
(Factory default)							
16	(Forbidden)		1	6	0	0	●
(Factory default)							
17	Height difference between indoor units	Standard	1	7	0	0	●
		Forbidden			0	1	
		Height difference			0	2	
		Forbidden			0	3	
		Forbidden			0	4	
If installing the indoor units (even only one set) to a lower floor than the outdoor unit, and the height difference between the indoor units is 119 in (3 m) or greater (i.e., if installing the indoor units on separate floors), set "02 (height difference)".							
20	Switching between batch stop or emergency stop *1	Batch stop	2	0	0	0	●
		Emergency stop			0	1	
This mode selects the pattern of the stop function to be operated by the external input terminal (CN134). • Batch stop: The stop of all indoor units connected to same refrigerant system due to input signal coming from CN134. • Emergency stop: When emergency stop is actuated, the indoor unit does not accept the operation command from the remote controller. On the other hand, when the emergency stop is released (no input from CN134), the air conditioner does not return to the original operation until the indoor unit is turned on by the remote controller.							
21	Operation mode selecting method *1	Priority given to the first command	2	1	0	0	●
		Priority given to external input of outdoor unit			0	1	
		Priority given to administrative indoor unit			0	2	
Select the priority setting of the operation mode. • Priority given to the first command: Priority is given to the operation mode which is set first. • Priority given to external input of outdoor unit: Priority is given to the operation mode which is set by the external input terminal (CN132). • Priority given to administrative indoor unit: Priority is given to the operation mode of the administrative indoor unit which is set by the wired remote controller.							
22	(Forbidden)		2	2	0	0	●
(Factory default)							
23	(Forbidden)		2	3	0	0	●
(Factory default)							
24	(Forbidden)		2	4	0	0	●
(Factory default)							
25	(Forbidden)		2	5	0	0	●
(Factory default)							
26	(Forbidden)		2	6	0	0	●
(Factory default)							
27	(Forbidden)		2	7	0	0	●
(Factory default)							
28	Change of unit (Temperature)	Celsius (°C)	2	8	0	0	●
		Fahrenheit (°F)			0	1	
29	Change of unit (Pressure)	Mpa	2	9	0	0	●
		psi			0	1	
30	Energy saving level setting *1	Level 1 (stop)	3	0	0	0	●
		Level 2 (operated at 40% capacity)			0	1	
		Level 3 (operated at 60% capacity)			0	2	
		Level 4 (operated at 80% capacity)			0	3	
		Level 5 (operated at 100% capacity)			0	4	
The capacity limit can be selected by the external input terminal (CN133) when operating with the "Energy Saving Peak Cut function". The lower the level, the more the effect of energy saving, but the cooling/heating performance will also drop.							
31	(Forbidden)		3	1	0	0	●
(Factory default)							
34	(Forbidden)		3	4	0	0	●
(Factory default)							
35	Presence of heater selection control using outdoor temperature *1	Invalid	3	5	0	0	●
		Valid			0	1	
If "Heater selection control 1 or 2 using outdoor temperature" is used for any of the indoor units of the refrigerant system, select "Valid". For more details on settings for this item, see the Design & Technical Manual.							

36	Outdoor temperature zone boundary temperature A *1	-4.0°F (-20°C)	3	6	0	0	●
		-0.4°F (-18°C)			0	1	
		3.2°F (-16°C)			0	2	
		6.8°F (-14°C)			0	3	
		10.4°F (-12°C)			0	4	
		14.0°F (-10°C)			0	5	
		17.6°F (-8°C)			0	6	
		21.2°F (-6°C)			0	7	
24.8°F (-4°C)	0	8					
For more details on settings for this item, see the Design & Technical Manual.							
37	Outdoor temperature zone boundary temperature B *1	42.8°F (6°C)	3	7	0	0	●
		14.0°F (-10°C)			0	1	
		17.6°F (-8°C)			0	2	
		21.2°F (-6°C)			0	3	
		24.8°F (-4°C)			0	4	
		28.4°F (-2°C)			0	5	
		32.0°F (0°C)			0	6	
		35.6°F (2°C)			0	7	
		39.2°F (4°C)			0	8	
		42.8°F (6°C)			0	9	
		46.4°F (8°C)			1	0	
		50.0°F (10°C)			1	1	
		53.6°F (12°C)			1	2	
		57.2°F (14°C)			1	3	
60.8°F (16°C)	1	4					
64.4°F (18°C)	1	5					
For more details on settings for this item, see the Design & Technical Manual.							
40	Capacity priority setting (in low noise mode) *1	Off (quiet priority)	4	0	0	0	●
		On (capacity priority)			0	1	
If the cooling/heating performance becomes insufficient when the low noise mode is set, it is possible to set "capacity priority" that automatically cancels the low noise mode (once performance is restored, the mode will automatically return to the low noise mode).							
41	Low noise mode setting *1	Off (Normal)	4	1	0	0	●
		On (Low noise mode)			0	1	
42	(Forbidden)		4	2	0	0	●
(Factory default)							
60	(Forbidden)		6	0	0	0	●
(Factory default)							
61	(Forbidden)		6	1	0	0	●
(Factory default)							
70	Electricity meter No. setting 1 *2	Setting number (x00)	7	0	0	0	●
		Setting number (x01)			0	1	
		.....			...	...	
		Setting number (x98)			9	8	
Set the ones digit and tens digit of the No. of the electricity meter connected to CN135.							
71	Electricity meter No. setting 2 *2	Setting number (0xx)	7	1	0	0	●
		Setting number (1xx)			0	1	
		Setting number (2xx)			0	2	
Set the hundreds digit of the No. of the electricity meter connected to CN135.							
72	Electricity meter pulse setting 1 *3	Setting number (xx00)	7	2	0	0	●
		Setting number (xx01)			0	1	
		.....			...	...	
		Setting number (xx98)			9	8	
Set the ones digit and tens digit of the No. of the electricity meter pulse setting connected to CN135.							
73	Electricity meter pulse setting 2 *3	Setting number (00xx)	7	3	0	0	●
		Setting number (01xx)			0	1	
		.....			...	...	
		Setting number (98xx)			9	8	
		Setting number (99xx)			9	9	
Set the hundreds digit and thousands digit of the electricity meter pulse setting connected to CN135.							
90	(Forbidden)		9	0	0	0	●
(Factory default)							

\*1: Do not set this for outdoor units with Slave setting.

\*2: When electricity meter No. is set to "000" and "201 to 299", the pulses input to CN135 become ineffective. Available setting number is "001" to "200"

\*3: When the electricity meter pulse setting is set to "0000", the pulses input to CN135 become ineffective. Available setting number is "0001" to "9999"

(1) Turn on the power of the outdoor unit and enter standby mode.

- When system is normal  
POWER/MODE lamp lights up. (ERROR lamp is off.)

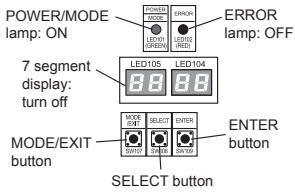

- When system is abnormal  
Check the settings as there is an error in the settings for outdoor unit address (DIP switch SET 3-1, 2) or number of connected slave units (DIP switch SET 3-3, 4).

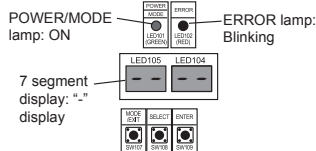

(2) Setting method

Use the "MODE/EXIT", "SELECT", and "ENTER" buttons to configure settings according to the procedures below.

(If no setting is made, the factory default setting will be displayed.)

- MODE/EXIT** : Press the "MODE/EXIT" button
- SELECT** : Press the "SELECT" button
- ENTER** : Press the "ENTER" button.
- ENTER** (with a diagonal line) : Press the "ENTER" button for more than 3 seconds.

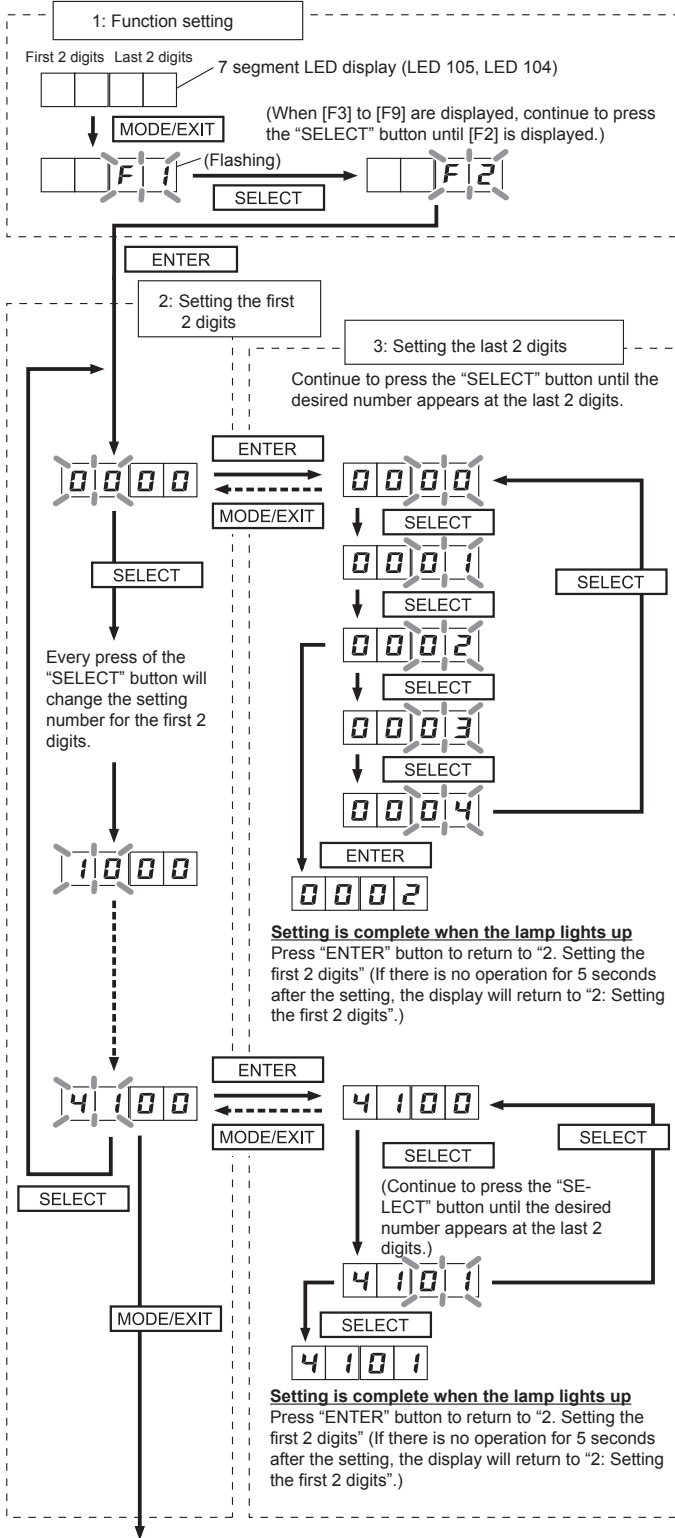

EXIT: Press the "MODE/EXIT" button to cancel the setting mode.

## 7.5. Address setting for signal amplifiers

### 7.5.1. Address setting for signal amplifiers

When using signal amplifiers, the address for signal amplifiers must be set. The address for signal amplifiers can be set automatically from 1 outdoor unit (master unit) on the network. Refer to "Fig. Wiring example for automatic address setting" (7.6.1 chapter) for the wiring example.

(For manual setting of address, refer to the signal amplifier installation manual.)

### 7.5.2. Automatic address setting for signal amplifiers

When setting the address of the signal amplifier, please use the factory setting. (See the installation manual of the signal amplifier)

- When the system is normal, nothing will be displayed on the 7 segment display.

- When ERROR is displayed, inspect the units.

Use the "MODE/EXIT", "SELECT", and "ENTER" buttons on the outdoor unit PC board to configure settings according to the procedures below.

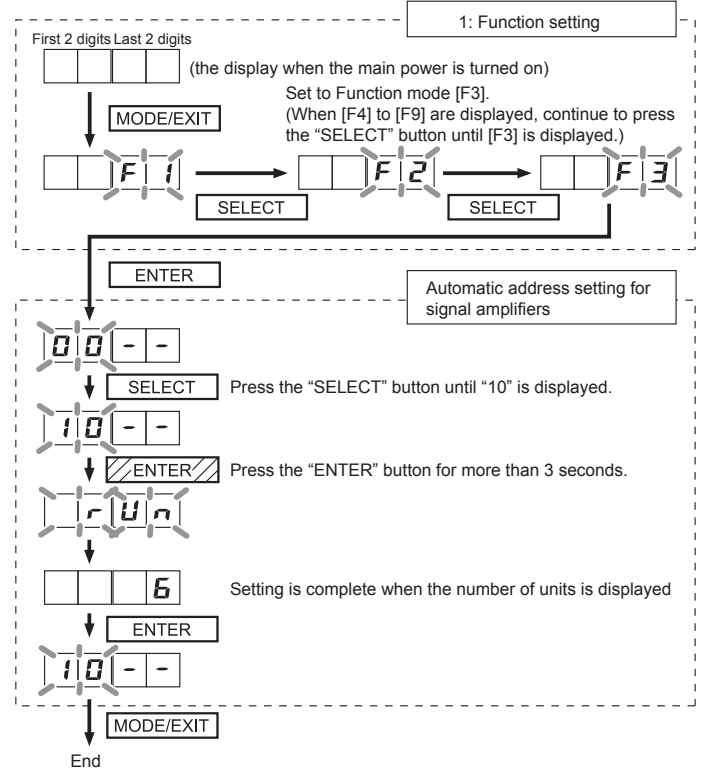

## 7.6. Indoor unit address setting

### 7.6.1. Indoor unit address setting

Address must be set for the indoor unit.

- Manual setting → When setting with the switch inside the indoor unit, refer to the indoor unit operating manual.
- Automatic setting → When setting with a remote control, refer to the remote control operating manual.
- Automatic setting → Check that the wiring is as shown in the figure below. Operate using the outdoor master unit of each refrigerant system.

### Fig. Wiring example for automatic address setting

(1): Signal amplifier wiring example

(2)(3)(4): Indoor unit wiring example

(Connect the indoor and outdoor units of the same refrigerant system as shown below.)

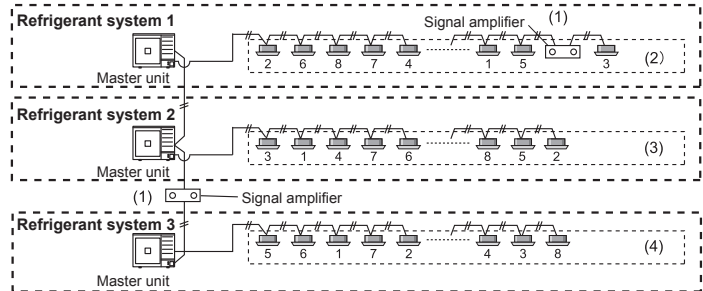

**NOTES:**

- The automatic address function can be used for a maximum of 8 indoor units installed to the same refrigerant system. When network is connected to other refrigerant systems, the automatic address function cannot be used.
- The addresses of indoor units that have been configured automatically cannot be assigned in the order when they are installed. (Refer to the indoor unit installation manual for the procedures to check the addresses.)

**7.6.2. Procedures to enable automatic address setting on indoor units**

Check that the rotary switch IU AD on the indoor unit PC board is set to "00". If it is not set to "00", it means the address of that device is not set. (Factory default is "00"). Turn on the power of the indoor and outdoor units.

- When the system is normal, nothing will be displayed on the 7 segment display.
- When ERROR is displayed, inspect the units.

Use the "MODE/EXIT", "SELECT", and "ENTER" buttons on the outdoor unit PC board to configure settings according to the procedures below.

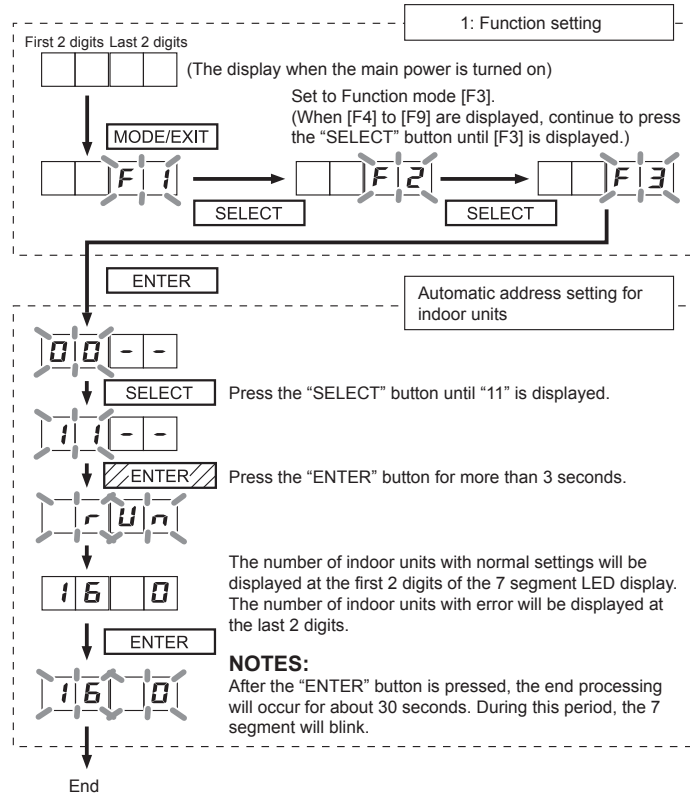

**7.7. Resistance measurement of transmission cable (Measure with breaker OFF)**

**CAUTION**  
Do not turn on the power if the resistance between the terminals of the transmission cable is abnormal. Otherwise, the PC board may be damaged.

Measure the resistance between 2 terminals of a transmission cable.

- Transmission cable connecting indoor units, outdoor units, and signal amplifiers**  
Measure the resistance of the signal amplifier terminal and the terminal of the indoor and outdoor units connected farthest away from the device where terminal resistor is measured. A value from the table is displayed, depending on the distance from the signal amplifier and the device where the terminal resistor is set. This value is an estimate.
- Transmission cable connecting outdoor units in a refrigerant system**  
The resistance between the terminals of the transmission cable is 45-60 Ω. This value is an estimate.

Approximate resistance (Ω)	Distance from termination resistor [ft (m)]				
	0~328 (0~100)	~656 (~200)	~984 (~300)	~1,312 (~400)	~1,640 (~500)
0 ~ 50	A short circuit somewhere or 2 or more termination resistors are connected				
50					
60					
70					
80					
90					
100					
110					
120					
130					
140					
150					
160					
170					
180					
190 ~	Faulty contact or wiring length over 1,640 ft (500 m)				
1K ~ ∞	Faulty contact, open circuit, or no termination resistor				

**8. PIPE INSTALLATION II**

**Fig. A Connection system**

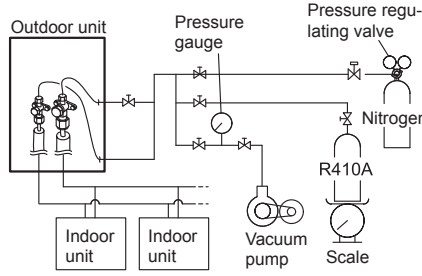

**Fig. B**

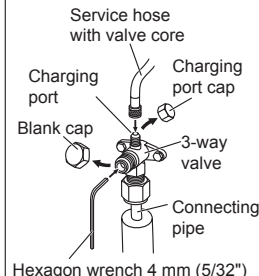

**Table. A**

Pipe	3-way valve	Blank cap	Charging port cap
Liquid valve	5.2 to 6.6 lbf-ft (7.0 to 9.0 N-m)	14.8 to 18.5 lbf-ft (20.0 to 25.0 N-m)	9.2 to 11.8 lbf-ft (12.5 to 16.0 N-m)
Gas valve	8.1 to 9.6 lbf-ft (11.0 to 13.0 N-m)	22.1 to 25.8 lbf-ft (30.0 to 35.0 N-m)	9.2 to 11.8 lbf-ft (12.5 to 16.0 N-m)

**8.1. Sealing test**

**CAUTION**  
Use only nitrogen gas. Never use refrigerant gas, oxygen, flammable gas or poisonous gas to pressurize the system. (If oxygen is used, there is a danger of an explosion.)  
Do not shock during sealing test. It can rupture the pipes and cause serious injury.  
Do not turn on the power unless all operations are complete.  
Do not block the walls and the ceiling until the sealing test and charging of the refrigerant gas have been completed.

After connecting the pipes, perform a sealing test. Recheck that the spindle of the 3-way valve are closed before performing a sealing test. (Fig. B)  
Pour nitrogen gas through both the liquid pipe and the gas pipe. Pressurize nitrogen gas to 609 psi (4.2 MPa) to perform the sealing test.

Check all flare connection and brazed areas. Then, check that the pressure has not decreased. Compare the pressures after pressurizing and letting it stand for 24 hours, and check that the pressure did not decrease.  
\* When the outdoor temperature changes 9 degrees F (5 degrees C), the test pressure changes 7.25 psi (0.05 MPa). If the pressure has dropped, the pipe joints may be leaking.

If a leakage is found, immediately repair it and perform a sealing test again.  
\* Decrease the pressure of nitrogen gas before brazing

After completing the sealing test, release the nitrogen gas from both valves. Release the nitrogen gas slowly.

**8.2. Vacuum process**

**CAUTION**  
Do not turn on the power unless all operations are complete.  
If the system is not evacuated sufficiently, its performance will drop.  
Be sure to evacuate the refrigerant system using a vacuum pump.  
The refrigerant pressure may sometimes not rise when a closed valve is opened after the system is evacuated using a vacuum pump. This is caused by the closure of the refrigerant system of the outdoor unit by the electronic expansion valve. This will not affect the operation of the unit.  
Use a clean gauge manifold and charging hose that were designed specifically for use with R410A. Using the same vacuum equipment for different refrigerants may damage the vacuum pump or the unit.  
Do not purge the air with refrigerants, but use a vacuum pump to evacuate the system.

- If moisture enters the piping, follow below. (i.e., if doing work during the rainy season, if the actual work takes long enough that condensation may form on the inside of the pipes, if rain might enter the pipes during work, etc.)
- After operating the vacuum pump for 2 hours, pressurize to 7.25 psi (0.05 MPa) (i.e., vacuum breakdown) with nitrogen gas, then depressurize down to 500 microns (-100.7 kPa) for an hour using the vacuum pump (vacuum process).
- If the pressure does not reach 500 microns (-100.7 kPa) even after depressurizing for at least 2 hours, repeat the vacuum breakdown - vacuum process perform triple evacuation procedure as necessary to bring the vacuum down to 500 microns (-100.7 kPa) or lower.

After vacuum process, maintain the vacuum for an hour and make sure the pressure does not rise by monitoring with a vacuum gauge.

### Evacuation procedure

- Remove the caps of the gas pipe and liquid pipe and check that the valves are closed.
- Remove the charging cap.
- Connect a vacuum pump and a pressure gauge to a charging hose and connect it to the charging port.
- Activate the vacuum pump and vacuum the indoor unit and connection piping until the pressure gauge becomes 500 microns (-100.7 kPa). Evacuate from both the gas pipe and the liquid pipe.
- Continue evacuating the system for 1 hour after the pressure gauge reads 500 microns (-100.7 kPa).
- Remove the charging hose and reinstall the charging cap.

### 8.3. Additional charging

#### CAUTION

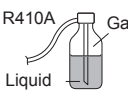
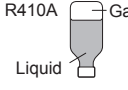
Do not turn on the power unless all operations are complete.	
After evacuating the system, add refrigerant.	
Do not charge the system with a refrigerant other than R410A.	
Always keep to the limit on the total amount of refrigerant. Exceeding the limit on the total amount of refrigerant will lead to malfunction during charging of refrigerant.	
Do not reuse recovered refrigerant.	
Use an electronic scale to measure the charging amount of refrigerant. Adding more refrigerant than the specified amount will cause a malfunction.	
Charge refrigerant using the liquid pipe. Adding refrigerant through the gas pipe will cause a malfunction.	
Add refrigerant by charging the system with the refrigerant in the liquid state. If the refrigerant cylinder is equipped with a siphon, it is not necessary to place the cylinder upright.	
Check if the steel cylinder has a siphon installed or not before filling. (There is an indication "with siphon for filling liquid" on the steel cylinder.)	
<b>Filling method for cylinder with siphon</b> 	R410A Gas Liquid Set the cylinder vertical and fill with the liquid. (Liquid can be filled without turning bottom up with the siphon inside.)
<b>Filling method for other cylinders</b> 	R410A Gas Liquid Turn bottom up and fill with liquid. (Be careful to avoid turning over the cylinder.)
Be sure to use the special tools for R410A for pressure resistance and to avoid mixing of impure substances.	
If the units are further apart than the maximum pipe length, correct operation can not be guaranteed.	
Make sure to back closing valve after refrigerant charging. Otherwise, the compressor may fail.	
Minimize refrigerant release to the air. Excessive release is prohibited under the Freon Collection and Destruction Law.	

#### 8.3.1. Procedure for charging the system with refrigerant

- Remove the charging port cap from the liquid pipe.
- Attach a charging hose to the refrigerant cylinder, and connect it to the charging port.
- Add refrigerant by calculating the additional refrigerant volume in accordance with the calculation formula indicated below.
- Remove the charging hose and install the charging port cap.
- Remove the blank caps (gas pipe and liquid pipe) and open the valves.
- Close the blank caps.
- After adding refrigerant, indicate the added charging volume on the unit.

\* Tighten the blank caps and charging port caps to the torque values specified in the Table A. To open and close the valves, use an M4 hexagon wrench.

#### 8.3.2. Checking total amount of refrigerant and calculating the amount of refrigerant charge to be added

- The amount of refrigerant charge to be added is the total value of the basic refrigerant charge amount and the value calculated from the length of the liquid pipe.
- Round up the value to 2 decimal places.

Model	"B" Factory charged amount [lb (kg)]	Diameter of liquid pipe [in (mm)]	"a" Additional amount for pipe length [lb/ft (kg/m)]
AOU36RLAVS	8.82 (4.0)	Ø 1/4 (6.35)	0.014 (0.021)
AOU48RLAVS	8.82 (4.0)	Ø 3/8 (9.52)	0.039 (0.058)

- Calculation of additional amount for pipe length

A =	Total length of Ø 3/8 in (Ø 9.52 mm) liquid pipe	+	Total length of Ø 1/4 in (Ø 6.35 mm) liquid pipe
	ft (m)		ft (m)
	$a \times 0.039$ ( $\times 0.058$ ) [lb/ft (kg/m)]		$a \times 0.014$ ( $\times 0.021$ ) [lb/ft (kg/m)]
			lb (kg)
	<b>Total</b>		lb (kg)

(Round up A to 2 decimal place)

- Calculation of total refrigerant amount

$$C = A + B = \text{[ ] lb (kg)} \quad (B : \text{Factory charged amount})$$

#### NOTES:

Check the total refrigerant amount under the following conditions

Condition	Computational formula
Total amount of refrigerant	$C \leq 15.06 \text{ lb (6.83 kg)}$

#### <Calculation>

Outdoor unit: AOU48RLAVS

- Calculation of additional amount for outdoor unit

If liquid pipe piping length is the following  
 Ø 3/8 in: 65 ft, Ø 1/4 in: 32 ft  
 (Ø 9.52 mm: 20 m, Ø 6.35 mm: 10 m)

Additional charge volume:

$$A = 65 \text{ ft} \times 0.039 \text{ lb/ft} + 32 \text{ ft} \times 0.014 \text{ lb/ft}$$

$$(A = 20 \text{ m} \times 0.058 \text{ kg/m} + 10 \text{ m} \times 0.021 \text{ kg/m})$$

$$= 3.02 \text{ lb (= 1.37 kg)}$$

- Check the total amount of refrigerant

$$C = A + B = 3.02 \text{ lb} + 8.82 \text{ lb} = 11.84 \text{ lb} \leq 15.06 \text{ lb}$$

$$(C = A + B = 1.37 \text{ kg} + 4.0 \text{ kg} = 5.37 \text{ kg} \leq 6.83 \text{ kg})$$

→No problem if the above condition is satisfied.

### 8.4. Installing insulation

- Install insulation material after conducting the "8.1 Sealing test".
- To prevent condensation and water droplets, install insulation material on the refrigerant pipe.
- Refer to the table to determine the thickness of the insulation material.
- If the outdoor unit is installed at a level that is higher than the indoor unit, the water that has condensed in the 3-way valve of the outdoor unit could travel to the indoor unit. Therefore, use putty in the space between the pipe and the insulation to prevent the entry of water.

#### Table. Selection of insulation

[Use an insulation material with equal heat transmission rate or below 0.023 BTU/ft·h·°F(0.040 W/m·k)]

Relative humidity	Insulation material				
	Minimum thickness [in (mm)]				
	≤ 70%	≤ 75%	≤ 80%	≤ 85%	
Pipe diameter [in (mm)]	1/4 (6.35)	5/16 (8)	3/8 (10)	1/2 (13)	11/16 (17)
	3/8 (9.52)	3/8 (9)	7/16 (11)	9/16 (14)	11/16 (18)
	1/2 (12.70)	3/8 (10)	1/2 (12)	9/16 (15)	3/4 (19)
	5/8 (15.88)	3/8 (10)	1/2 (12)	5/8 (16)	13/16 (20)

\* When an ambient temperature and relative humidity exceed 90 °F (32 °C), please strengthen heat insulation of refrigerant pipe.

### 8.5. Filling with putty

#### WARNING

Fill the piping holes and wiring holes with putty (supplied locally) to avoid any gap (Fig A). If small animals such as insects enter the external unit, a short circuit may be caused near electrical components in the service panel.

If the outdoor unit is installed at a level that is higher than the indoor unit, the water that has condensed in the 3-way valve of the outdoor unit could travel to the indoor unit. Therefore, use putty in the space between the pipe and the insulation to prevent the entry of water to the indoor units.

Fig. A

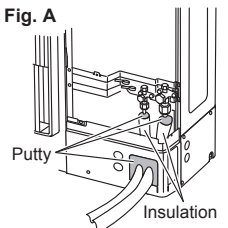



## 9. TEST RUN

### 9.1. Indoor unit connection check

Normal operation will not be possible without performing the Indoor unit connection check.

#### 9.1.1. Things to confirm before starting the Indoor unit connection check

To ensure safety, check that the following work, inspections and operations have been completed.

Check Item	Check Column
(1) Check that all work on the wiring connecting the outdoor unit and indoor units has been completed.	
(2) Is a breaker installed at the power supply cable of outdoor unit and every indoor units?	
(3) Are the cables connected to the terminals without looseness, and in accordance with the specifications?	
(4) Are all the indoor units stopped? Indoor unit connection check can not be performed if any unit is operating.	
(5) Is the connection to Service tool (UTY-ASGX) and Web monitoring tool (UTY-AMGX) stopped?	

#### 9.1.2. Operating procedure for Indoor unit connection check

Please perform the indoor unit connection check according to following procedures. The Indoor unit connection check can be completed within several minutes.

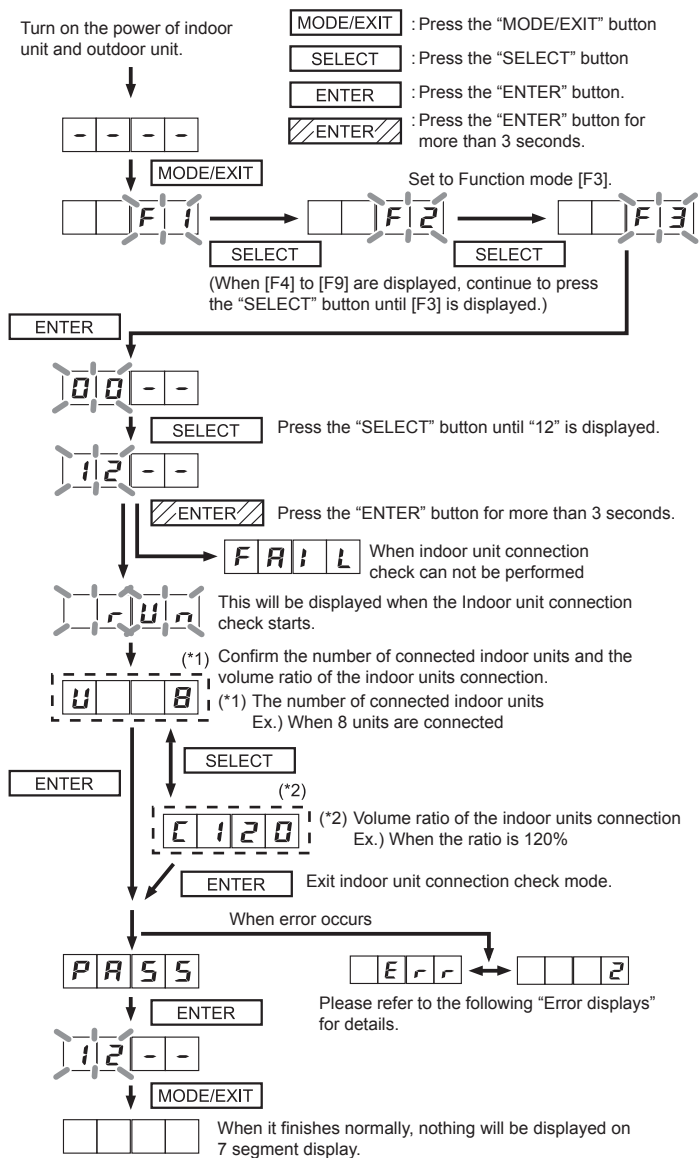

### 9.1.3. Error displays

- When error occurs, "Err" and "Number of errors occurred" are alternately displayed on the 7 segment display every 1 second.
- For the content of error, please refer to the "10.2. Error codes".
- When error codes are displayed, all the error codes can be confirmed by pressing the "SELECT" button.

#### Example:

When "Indoor unit capacity error [E221]" and "Indoor unit duplicate address error [E261]" occurred.

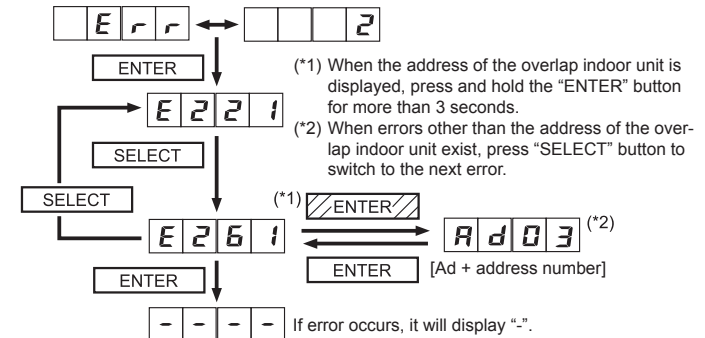

## 9.2. Test run

Before the test operation, check the following items.

- Is there a gas leakage? (At pipe connections (flange connections and brazed areas))
- Is the system charged with the specified volume of refrigerant?
- Is the refrigerant circuit address correct?
- Is a breaker installed at the power supply cable of outdoor unit?
- Are the cable connected to the terminals without looseness, and in accordance with the specifications?
- Are the initial settings of the switches of the outdoor unit correctly configured?
- Is the 3-way valve of the outdoor unit open? (Gas pipe and liquid pipe)
- Is power supplied to the crank case heater for more than 12 hours? Electricity current in short period of time may result in compressor damage.
- Are all the indoor units within the same coolant system connected to the power? Operating indoor units which are not connected to the power may result in malfunctions.
- Is Indoor unit connection check performed? Test run doesn't operate if Indoor unit connection check is not performed.



After checking that the above items are all in order, refer to "9.3. Test run method" to test operation the unit. If there are problems, adjust immediately and recheck.

## 9.3. Test run method

**Be sure to configure test run settings only when the outdoor unit has stopped operating.**

- Depending on the communication status between the indoor and outdoor units, it may take several minutes for the system to start operating after settings for the test run are complete.
- After the test run settings are complete, the outdoor unit and the connected indoor units will start operating. Room temperature control will not activate during test operation (continuous operation).
- If a knocking sound can be heard in the liquid compression of the compressor, stop the unit immediately and then energize the crank case heater for a sufficient length of time before restarting the operation.

Perform test operation for each refrigerant system.

You can set "cooling test operation" or "heating test operation" with the push button on the outdoor unit PC board.

### Test operation setting method

Use the "MODE/EXIT", "SELECT", and "ENTER" buttons on the indoor unit PC board to configure settings according to the procedures below.

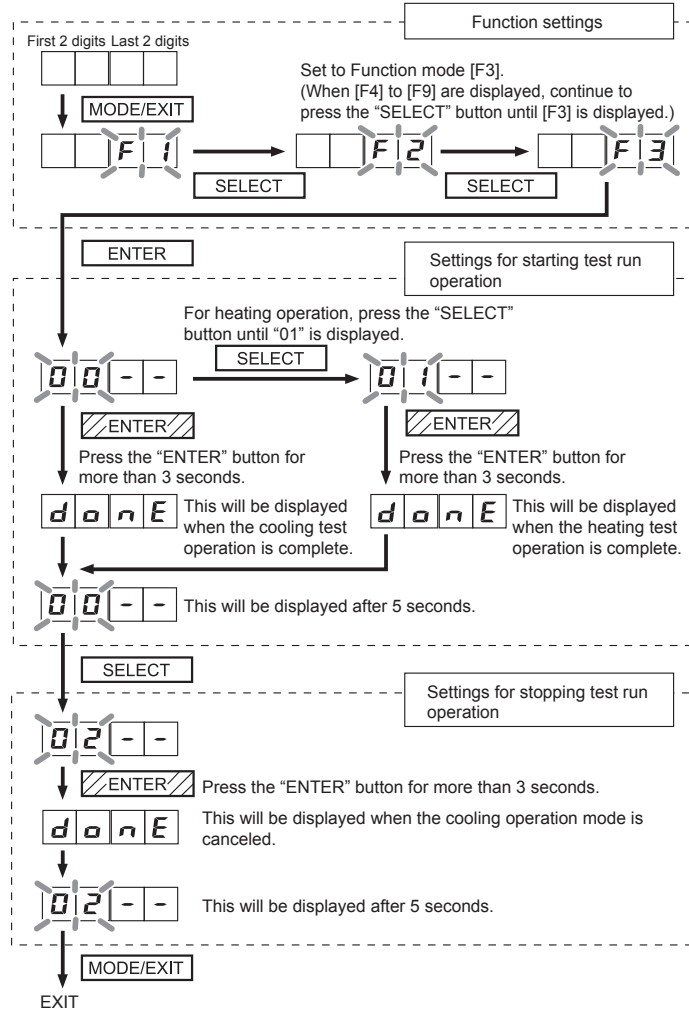

After the test operation is complete, turn off the power. Attach the cover of the electrical component box and the front panel of the outdoor unit.

#### NOTES:

- Check that the indoor and outdoor units connected to the same refrigerant system are operating normally.
- When indoor or outdoor units are not operating, or when the indoor and outdoor units of other refrigerant systems are operating, the indoor/outdoor unit address are not configured correctly.
- The system will not operate normally with an incorrect DIP switch setting. Stop the system immediately and recheck the DIP switch setting.

### 9.4. Checklist

	Check description	Check method	Criteria
1	High and low pressure values are normal.	Check it with a pressure gauge.	Cooling: low pressure approx. 116 psi (0.8 MPa) Heating: high pressure approx. 435 psi (3.0 MPa)
2	Drain water is discharged smoothly through the drain hose.	Check it by pouring water.	—
3	Indoor and outdoor unit fans are operating.	Check them visually.	—
4	Compressor operates after the indoor unit operates.	Check the operating sound.	—
5	Difference between inlet and outlet temperatures is normal.	Measure the inlet and outlet temperatures.	Temperature difference 10 degrees
6	Error is not displayed	Check the 7 segment LED display	Error blinking or no error code display

## 10. LED STATUS

You can determine the operating status by the lighting up and blinking of the LED display. Check the status using the table below.

### 10.1. Normal operation codes

Mode	Code	Description
Operation	C L	Cooling
	H t	Heating
	o r	During oil recovery operation
	d F	During defrosting operation
	P C	During power saving operation
	L n	During low noise operation

### 10.2. Error codes

Mode	Code	Description
Communication error	E 1 4. 2	Outdoor unit network communication 2 error
	E 1 4. 5	The number of indoor unit shortage
Function setting error	E 2 2. 1	Indoor unit capacity error
	E 2 4. 2	Connection unit number error (Indoor unit)
	E 2 6. 1	Indoor unit duplicate address error
	E 2 8. 1	Auto address setting error
Indoor unit actuator error	E 2 8. 4	Signal amplifier auto address error
	E 5 U. 1	Indoor unit miscellaneous error
Outdoor unit PCB/Electrical component/ Switch error	E 6 2. 3	Outdoor unit EEPROM access error
	E 6 2. 6	Outdoor unit inverters communication error
	E 6 2. 8	Outdoor unit EEPROM data corruption error
	E 6 3. 1	Outdoor unit inverter error
	E 6 7. 2	Outdoor unit inverter PCB power short interruption error
	E 6 8. 2	Outdoor unit rush current limiting resistor temp. rise error (protective operation)
Outdoor unit sensor error	E 6 9. 1	Outdoor unit transmission PCB parallel communication error
	E 7 1. 1	Outdoor unit discharge temp. thermistor 1 error
	E 7 2. 1	Outdoor unit compressor temp. thermistor 1 error
	E 7 3. 3	Outdoor unit heat ex. liquid temp. thermistor error
	E 7 4. 1	Outside air temp. thermistor error
	E 7 5. 1	Outdoor unit suction gas temp. thermistor error
	E 7 7. 1	Outdoor unit heat sink temp. thermistor error
	E 8 4. 1	Outdoor unit current sensor 1 error (permanent stop)
	E 8 6. 1	Outdoor unit discharge pressure sensor error
	E 8 6. 3	Outdoor unit suction pressure sensor error
Outdoor unit actuator error	E 9 3. 1	Outdoor unit inverter compressor start up error
	E 9 4. 1	Outdoor unit trip detection
	E 9 5. 5	Outdoor unit compressor motor loss of synchronization
	E 9 7. 1	Outdoor unit fan motor 1 lock error
	E 9 7. 4	Outdoor unit fan motor 1 undervoltage error
	E 9 7. 5	Outdoor unit fan motor 1 temperature error (protective action)
Refrigerant system error	E 9 A. 1	Outdoor unit coil 1 (expansion valve 1) error
	E A 1. 1	Outdoor unit discharge temperature 1 error (permanent stop)
	E A 3. 1	Outdoor unit compressor 1 temperature error
	E A 4. 1	Outdoor unit high pressure error
	E A 5. 1	Outdoor unit low pressure error
E A C. 4	Outdoor unit heat sink temperature error	

#### 7 segment LED indicator:

A: A C: C E: E F: F H: H J: J L: L S: S P: P U: U d: d n: n o: o r: r t: t  
1: 1 2: 2 3: 3 4: 4 5: 5 6: 6 7: 7 8: 8 9: 9 0: 0