

## FSH1BF Series

### Extra High Efficiency Heat Pump

16 SEER Residential System  
2 - 5 Ton Capacity

The FSH1BF Series of heat pumps offers exceptional performance as well as environmental protection. These models, when matched with our variable speed air handlers or variable speed equipped gas furnaces, offer a line of high quality heat pump systems rated up to 16 SEER and 9.0 HSPF.



### FEATURES and BENEFITS

- **CoreSense™ Compressor Protection:** Control module actively monitors compressor conditions and will shut the unit down to prevent damage.
- **Copeland Scroll UltraTech™ Compressor:** The Ultra Tech Compressor operates with 2 stages of heating and cooling capacities to provide superior comfort and efficiency. Copeland's proven and simple design equates to years of comfort and reliability for the homeowner with virtually silent operation.
- **Designed Using Galvanized Steel:** With a polyester urethane coat finish, it passes 950 hours of salt spray per ASTM Std. B117.
- **Composite Base Pan:** Absorbs sound and is corrosion resistant. Composite is also stronger and lighter than steel.
- **Micro-Channel Coils:** All aluminum coils in all models which provides high corrosion resistance.
- **Demand Defrost:** Provides additional energy savings in heating by defrosting only when necessary.
- **Removable Top Grille Assembly:** Allows ease of service from the top without disconnecting fan motor leads.
- **Compressor Sound Blanket:** Engineered to significantly reduce unwanted compressor noise.
- **Swept-Wing Fan Blade:** Designed to significantly reduce unwanted noise.
- **Low Pressure Switch:** Loss of charge protection ensures long compressor life. Auto-reset feature prevents nuisance service visits.
- **High Pressure Switch:** Protects against abnormally high system pressures. Auto-reset feature prevents nuisance service visits.
- **Liquid Line Filter Drier:** Included with unit, field installed.
- **One Piece Top/Orifice:** Designed for maximum airflow and quiet operation.
- **Common Suction Service Port:** This port allows the contractor to read the suction pressure in all modes of operation without removing any panels, saving time and increasing serviceability.
- **Five Minute Restart Time Delay:** When the unit shuts down, a five minute delay keeps the unit from restarting, eliminating the highest cause for compressor failure.
- **Suction Accumulator:** Protection from liquid flood back and future compressor failures.
- **Hot Gas Muffler:** Reduces compressor noise and vibration.
- **Easy Compressor and Control Access:** Designed to make servicing easier for the contractor, access panels are provided to all controls and the compressor from the side of the unit.
- **Service-Friendly Jacket:** Side panels can be easily removed and replaced without removing the top grill.



# MODEL IDENTIFICATION CODES

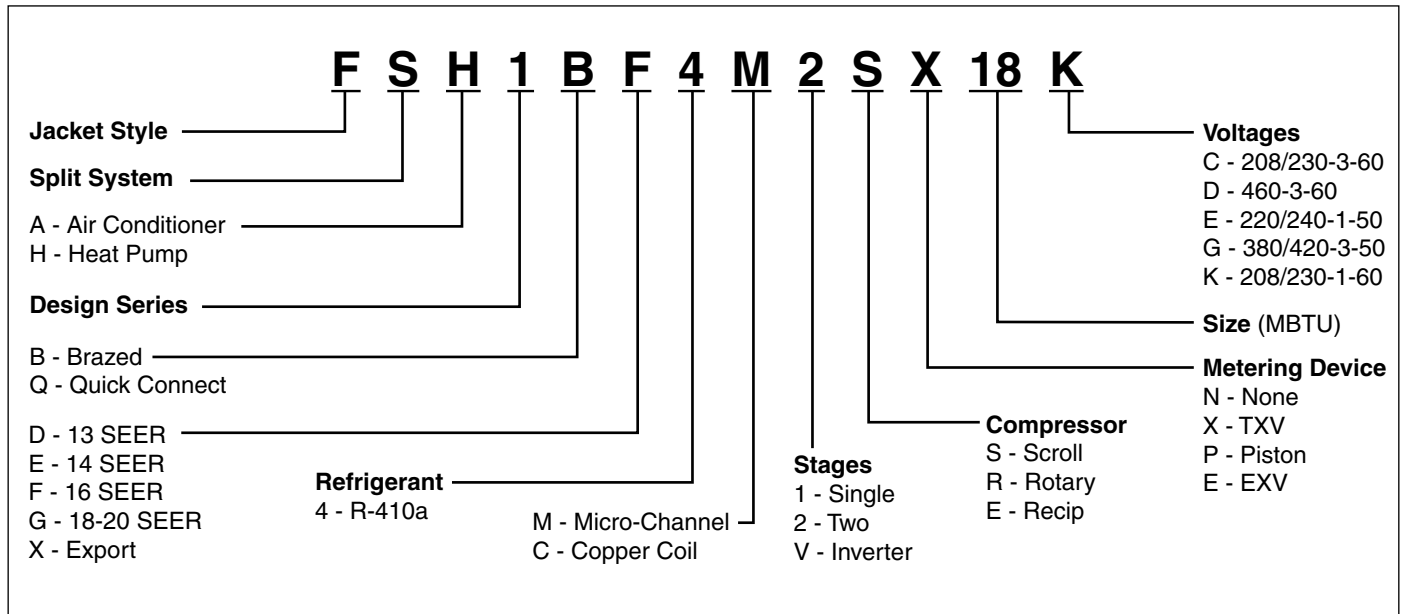

## DIMENSIONS

### AIR CONDITIONER OUTDOOR SECTION

FSH1BF	24K	36K	48K	60K
H	37.25	45.25	45.25	45.25
W	31.75	31.75	31.75	31.75
D	31.75	31.75	31.75	31.75

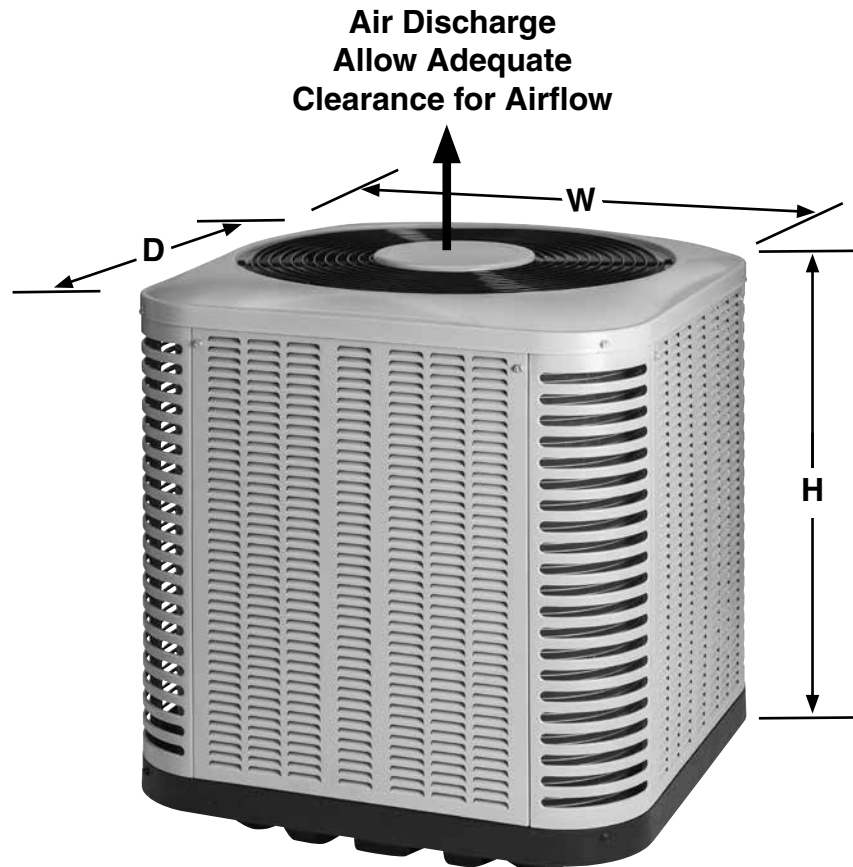

# PHYSICAL AND ELECTRICAL SPECIFICATIONS / OUTDOOR UNITS

## 16 SEER — Extra High Efficiency — Single Phase

Model Number FSH1BF		24K	36K	48K	60K	
Electrical Data	Volts-Cycles-Phase (1)	208/230-60-1				
	Total Amps	12.6	17.8	23.7	31.4	
	Delay Fuse Max. (2)	25	35	50	60	
	Min. Circuit Ampacity	15.5	21.6	29.0	38.6	
Component Data	Fan Motor	Type	PSC			
		Amps	0.9	2.6	2.6	2.6
		HP	0.13	0.33	0.33	0.33
	Compressor Data	RLA	11.6	15.2	21.1	28.8
		LRA	58.3	83.0	104.0	152.9
Refrigerant suction line O.D. NOTE: Liquid line is 3/8" O.D. for entire length."	0-24 ft.	3/4"	7/8"	7/8"	7/8"	
	25-39 ft.	7/8" (3)	1-1/8" (4)	1-1/8" (4)	1-1/8" (4)	
	40-75 ft.	7/8" (3)	1-1/8" (4)	1-1/8" (4)	1-1/8" (4)	
Approximate Weight (lbs.)	Net	201	212	234	236	
	Ship	212	225	247	249	
Sound Ratings db		75	75	76	78	

(1) Operating voltage range: 187v minimum - 253v maximum.

(2) HACR type circuit breakers may be used.

(3) Requires 7/8" to 3/4" reducer from line to unit.

(4) Requires 1-1/8" to 7/8" reducer from line to unit..

(5) Additional charge for line sets above 15 feet. Values based on suction line as follows with 3/8" liquid line.

a) 3/4" = 0.6 oz per additional foot.

b) 7/8" = 0.7 oz per additional foot.

c) 1-1/8" = 0.8 oz per additional foot.

(6) For additional charging instructions please refer to the QRD.

## SYSTEM HEATING AND COOLING CAPACITIES

### 16 SEER — Extra High Efficiency — Single Phase

Outdoor Unit	Indoor Unit	Furnace Model	Cooling - High Speed Capacity (Btu/h)	SEER	EER	High Speed SCFM	Low Speed SCFM	Heating - High Speed Capacity (Btu/h)	HSPF
FSH1BF4M2SX24K	B6VMMX24K-B		23,000	16.0	13.0	855	855	22,600	9.0
FSH1BF4M2SX24K	C7B(A,H)MX24(C,U)-B	FG7S(*)-B(*) + VSHE	23,000	15.5	12.5	860	860	23,000	8.8
FSH1BF4M2SX24K	C7B(A,H)MX24(C,U)-B	FG7T(*)-VB(*)	23,000	15.5	12.5	860	860	23,000	8.8
FSH1BF4M2SX24K	C7B(A,H)MX24(C,U)-B	MB7VM-(*)B	23,000	16.0	13.0	855	855	22,600	9.0
FSH1BF4M2SX36K	B6VMMX36K-B		35,000	16.0	12.5	1,310	875	34,600	9.0
FSH1BF4M2SX36K	B6VMMX48K-C		35,000	16.0	13.0	1,190	810	34,400	9.0
FSH1BF4M2SX36K	C7B(A,H)MX36(C,U)-B	FG7S(*)-B(*) + VSHE	35,000	15.5	12.0	1,190	795	35,000	8.5
FSH1BF4M2SX36K	C7B(A,H)MX36(C,U)-B	FG7T(*)-VB(*)	35,000	15.5	12.0	1,190	795	35,000	8.5
FSH1BF4M2SX36K	C7B(A,H)MX36(C,U)-B	MB7VM-(*)B	35,000	16.0	12.5	1,310	875	34,600	9.0
FSH1BF4M2SX36K	C7B(A,H)MX36(C,U)-C	FG7S(*)-C(*) + VSHE	35,000	16.0	12.5	1,190	795	35,000	9.0
FSH1BF4M2SX36K	C7B(A,H)MX36(C,U)-C	FG7T(*)-VC(*)	35,000	16.0	12.5	1,190	795	35,000	9.0
FSH1BF4M2SX36K	C7B(A,H)MX36(C,U)-C	MB7VM-(*)C	35,000	16.0	13.0	1,190	810	35,000	9.0
FSH1BF4M2SX48K	B6VMMX48K-C		45,500	16.0	12.5	1,530	1,060	46,000	9.0
FSH1BF4M2SX48K	C7B(A,H)MX48(C,U)-C	FG7S(*)-C(*) + VSHE	46,000	15.5	12.5	1,300	875	46,000	8.5
FSH1BF4M2SX48K	C7B(A,H)MX48(C,U)-C	FG7T(*)-VC(*)	46,000	15.5	12.5	1,300	875	46,000	8.5
FSH1BF4M2SX48K	C7B(A,H)MX48(C,U)-C	MB7VM-(*)C	45,500	16.0	12.5	1,530	1,060	46,000	9.0
FSH1BF4M2SX48K	C7B(A,H)MX48(C,U)-D	FG7S(*)-D(*) + VSHE	46,000	15.5	12.5	1,300	875	46,000	8.5
FSH1BF4M2SX48K	C7B(A,H)MX48(C,U)-D	FG7T(*)-VD(*)	46,000	15.5	12.5	1,300	875	46,000	8.5
FSH1BF4M2SX60K	B6VMMX60K-C		55,000	16.0	11.5	1,835	1,280	55,000	8.5
FSH1BF4M2SX60K	C7B(A,H)MX60(C,U)-C	FG7S(*)-C(*) + VSHE	55,000	15.5	11.5	1,760	1,180	55,000	8.5
FSH1BF4M2SX60K	C7B(A,H)MX60(C,U)-C	FG7T(*)-C(*)	55,000	15.5	11.5	1,760	1,180	55,000	8.5
FSH1BF4M2SX60K	C7B(A,H)MX60(C,U)-C	MB7VM(*)C	55,000	16.0	11.5	1,835	1,280	55,000	8.5
FSH1BF4M2SX60K	C7B(A,H)MX60(C,U)-D	FG7S(*)-D(*) + VSHE	55,000	15.5	11.5	1,760	1,180	55,000	8.5
FSH1BF4M2SX60K	C7B(A,H)MX60(C,U)-D	FG7T(*)-D(*)	55,000	15.5	11.5	1,760	1,180	55,000	8.5

See current AHRI Directory for certified combinations and ratings.

[www.ahridirectory.org](http://www.ahridirectory.org)

## ACCESSORIES - Condensing Unit

### Start Assist Kit - 912933

Provides additional starting torque for the compressor motor when operating with low line voltage or high operating temperatures.

### Extreme Wind Condition Mounting Kit - 1017210

### Low Ambient Kit - 918837

## PANEL REMOVAL AND REPLACEMENT INSTRUCTIONS

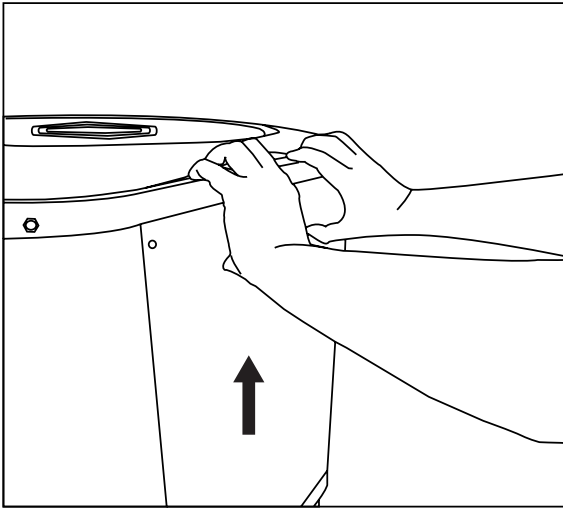

### Removing Panels:

1. Remove screws.
2. Pull up on panel.
3. Rotate bottom of panel out.
4. Pull panel off.

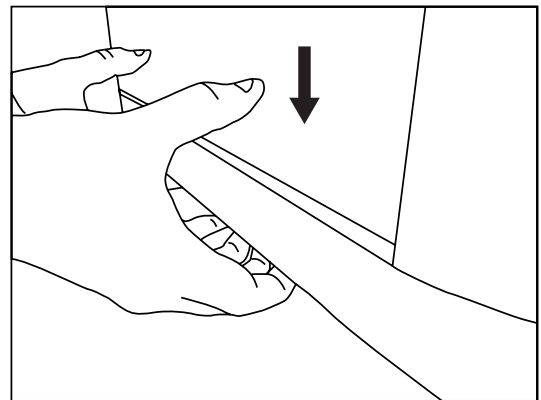
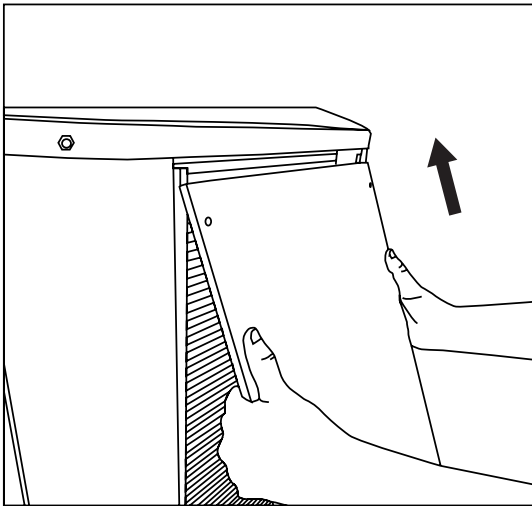
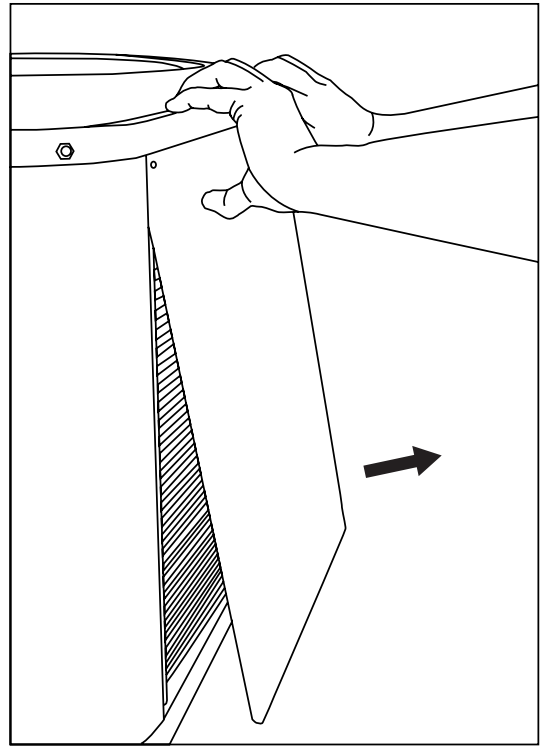

### Reinstalling Panels:

1. Place panel back in towards top of unit.
2. Rotate bottom of panel inwards.
3. Push panel down until it fills gap at bottom of unit.
4. Replace screws.











# CORESENSE™ DIAGNOSTIC MODULE

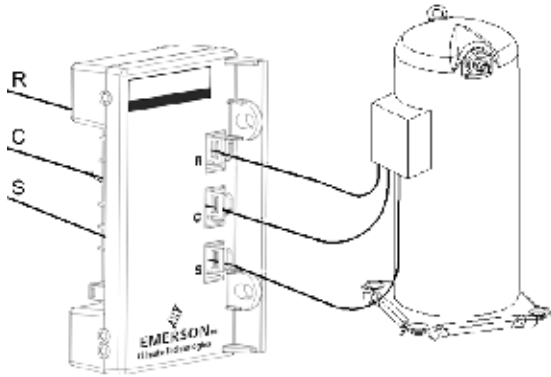

**Figure 1**  
Wires Pulled Through Module

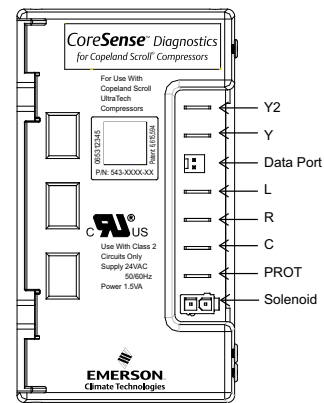

**Figure 2**  
Terminal Locations

CoreSense™ Flash Code Description			
Alert Code	Alert Condition	Lockout Level	Lockout Indication
Normal Run Solid Green	Normal operation, no trip.	N/A	N/A
Code1 Yellow Flash 1	Long run time. Compressor is running for more than 18 hours at full load. (Code1 is disabled in Heat Pump mode.)	N/A	N/A
Code2 Yellow Flash 2	Compressor Pressure trip. Compressor runs for 12sec to 15min followed by a compressor trip condition lasting longer than 7min.	4x consecutive, 10x total	Red: Flash 2
Code 3 Yellow Flash 3	Pressure switch cycling. Compressor runs for 12sec to 15min followed by a compressor trip lasting between 35sec to 7min.	4x consecutive, 10 total	Red: Flash 3
Code4 Yellow Flash 4	Locked rotor. Compressor trips within a compressor run time of 12sec and does not start within 35sec.	10x consecutive	Red: Flash 4
Code5 Yellow Flash 5	Compressor moderate run trip. Compressor runs for 15min to 18hrs followed by a compressor trip lasting longer than 7min.	4x consecutive, 10x total	Red: Flash 5
Code6 Red Flash 6	Open start circuit. Module has detected Y or Y1, and current in the R winding of the compressor and no current in the S winding of the compressor for 2 seconds.	1 occurrence	Red: Flash 6
Code7 Red Flash 7	Open run circuit. Module has detected Y or Y1, and current in the S winding of the compressor and no current in the R winding of the compressor for 2 seconds.	1 occurrence	Red: Flash 7
Code8 Yellow Flash 8	Welded Contactor. Module has detected line currents in R and S windings, and Y or Y1 is at 0 VAC for 15 seconds.	N/A	N/A
Code9 Yellow Flash 9	Low Voltage. Module has detected a 24 VAC supply voltage below 17 VAC +/- 1 VAC for 2 seconds	N/A	N/A
Code10 Red Flash 10	Over Current Protection. PROT terminal has above a 2A input for more than 40 milliseconds.	1 occurrence	Red: Flash 10





### GENERAL TERMS OF LIMITED WARRANTY

Nortek Global HVAC, LLC will furnish a replacement for any part of this product which fails in normal use and service within the terms and conditions of the warranty.

For complete details of the Limited Warranty, including applicable terms and conditions, see your local installer or contact the Nortek Global HVAC, LLC warranty department for a copy.

Before purchasing this appliance, read important energy cost and efficiency information available from your retailer. Specifications and illustrations subject to change without notice and without incurring obligations. Printed in U.S.A (05/2017)