

REV	NOTES	DATE

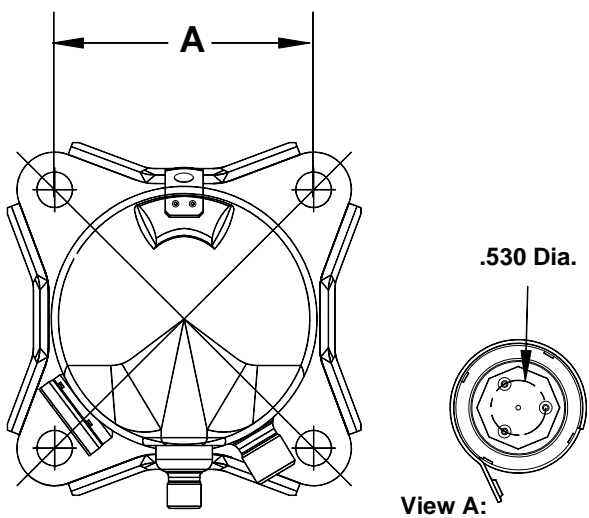

Notes:

1. Oil Type: Mineral
2. A molded plug wiring harness is included with this compressor.
3. Tube ends must be plugged.
4. See ADS-5241-01 for cleanliness of refrigerant containing components.

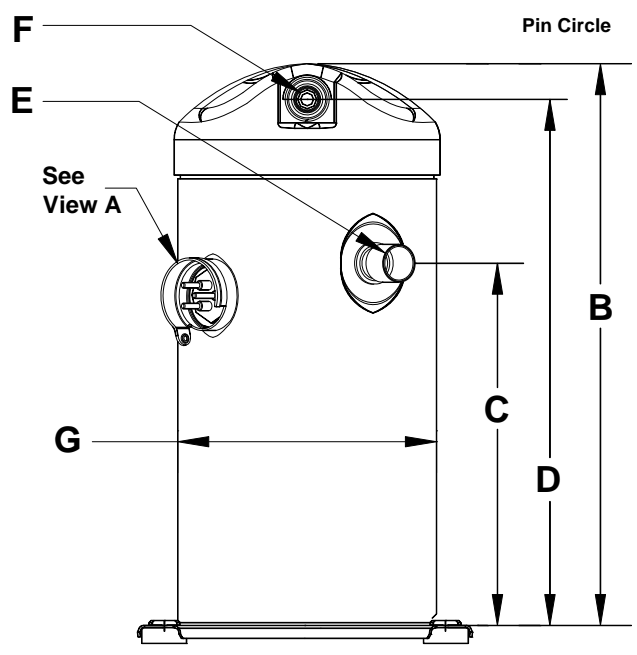

Unless otherwise noted, dimensional tolerances are as follows:

- 2 Place Decimal: +/- .13
- 3 Place Decimal: +/- .060
- Angular: +1 degree; -3 degrees

Manufacturer	Manufacturer's Model Number	BOM No.	Capacity (BTU/HR)	Type	Refrigerant	Input Voltage (V)	No. of Phases	Freq. (Hz.)	Rated Load Current (A)	Max. Continuous Current (A)	Locked Rotor Current (A)	
Copeland	ZR32K5-PFV	ZR32K5-PFV-800	32,600	Scroll	R-22	208/230	1	50/60	17.1	24.0	87.0	
Start Capacitor	Start Relay	Run Capacitor	Crankcase Heater Included?	Recommended Crankcase Heater Wattage	Diameter (in.)	Suction Line Height (in.)	Suction Line Size (in.)	Discharge Line Height (in.)	Discharge Line Size (in.)	Overall Compressor Height (in.)	Mounting Base Dimensions (in. X in.)	UL File No.
88-106/330	3ARR3T3P5	50/370	No	40	G	C	E	D	F	B	A	SA2337

Drawn By: DGR 3/26/10
 Reviewed By: ESP 4/22/10
 Date:

RHEEM CONFIDENTIAL INFORMATION. NO REVISION TO DESIGN, MATERIAL, TOOLING OR PROCESS IS ACCEPTABLE WITHOUT PRIOR APPROVAL FROM RHEEM THROUGH A REVISED ENGINEERING SPECIFICATION AND A RESAMPLING OF PARTS. THE SUPPLIER IS RESPONSIBLE FOR NOTIFYING RHEEM PARTS DEPARTMENT AND PURCHASING DEPARTMENTS IN WRITING OF ANY CHANGES AFFECTING PRODUCT QUALITY, PERFORMANCE, RELIABILITY, PACKAGING, DELIVERY OR WORKMANSHIP. ANY DOCUMENTS REFERRED TO ON THIS DRAWING ARE INCLUDED IN THE SPECIFICATIONS FOR THIS COMPONENT.



Compressor

Part No.
ZR32K5-PFV-800