

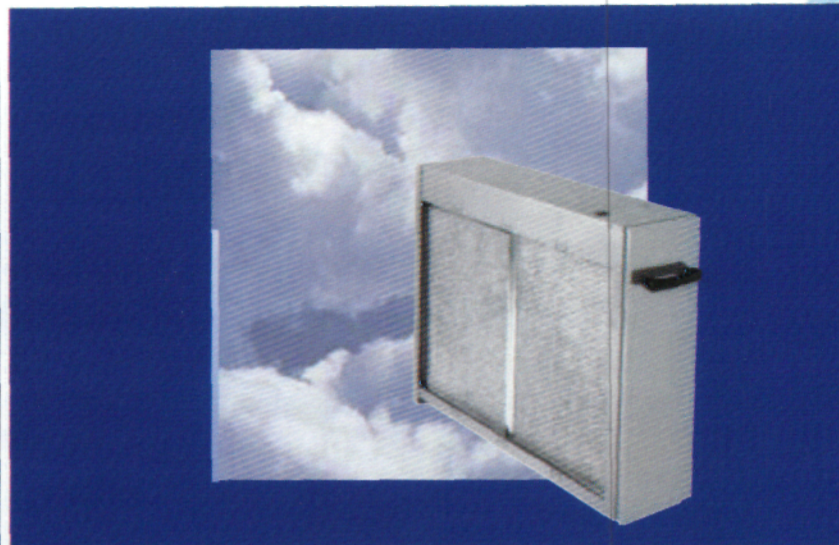

## The Electronic Air Cleaner



### **Energy Efficient**

The ADAMS Cleanaire cuts heating and cooling costs. By lowering the amount of outside air brought in which must be cleaned, heated, cooled, humidified or dehumidified, ADAMS Cleanaire saves you money.

With more insulation and tighter seals around doors and windows, the newer home has less natural ventilation.

That's why so many homeowners open doors and windows to "air out" their homes... to get rid of the stale air that has no way out. In a way the ADAMS Cleanaire "airs out" your home without opening doors and windows.

It saves even more energy, because it doesn't restrict airflow the way media filters do as they load.



### **Healthier Living Environment**

You will feel healthier because the ADAMS Cleanaire removes 99% of the bacteria-laden pollen and mold spores and up to 95% of the dust and dirt that get in to your home.

Allergy sufferers may find the Cleanaire to be especially beneficial because it takes out so many of the things that bother them.

You will be pleased by the way your ADAMS Cleanaire cuts cleaning...and costly redecorating, too.

## Cleans Air Better

Neither ordinary furnace filters nor high efficiency media filters are enough.

About 98% of the airborne impurities by particle count are below one micron or smaller than 1/25,400 of an inch. In fact these particles are so small that you can't see them until they appear as stains on your furnishings and walls. What you can't see not only can hurt you, but also can make you uncomfortable by irritating your eyes, nose, throat, lungs and even your skin.

Below one (1) micron, the High Efficiency Media air cleaner loses its effectiveness and most of these small particles pass right through them.

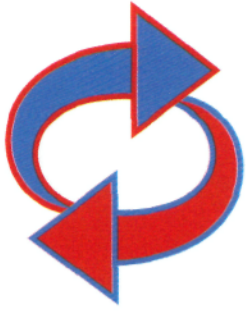

## Easier Maintenance



ADAMS Cleanaire is easy to maintain. It's as easy as washing dishes. The lightweight collector cells may be put into a dishwasher or soaked and rinsed in the sink.



## Lasts Longer

The rugged construction eliminates costly service calls. The collector cells are so strong, you could stand on them without causing damage. These cells, dependable solid state power supply and heavier gauge cabinets are built to last the life of the house and add a permanent home improvement.



**ADAMS**  
MANUFACTURING COMPANY

9790 Midwest Ave. • Cleveland, Ohio 44125

(216) 587-6801

adamsx@att.net

Available from:

[www.adamsmanufacturing.com](http://www.adamsmanufacturing.com)

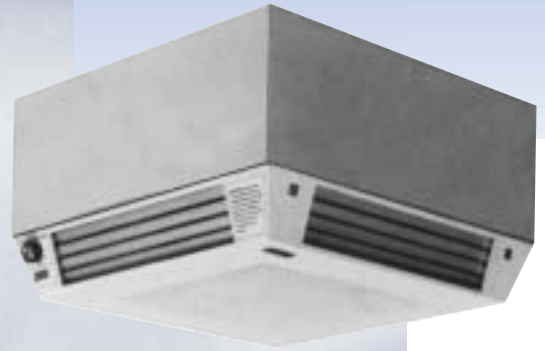

# ADAMS cleanaire<sup>®</sup>

The Electronic Air Cleaner  
for Every Application

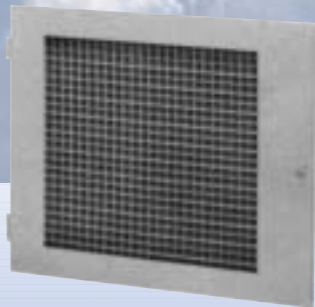



## Electronic Air Cleaner

### 24 VOLT CENTRAL SYSTEM ELECTRONIC AIR CLEANER

#### Installs Easier

- Connects with 24 volt wires from the existing transformer on the heating and/or air conditioning unit to the air cleaner directly. Cheaper, faster and easier to install.
- Eliminates the need for a sail switch or pressure switch with a built-in solid state airflow sensing device.
- Uses 40VA transformer already on the furnace and/or air conditioner. Power supply boosts the 24-volt input to proper high voltage to the collector cells.

#### Cleans Air Better

- Maintains constant output voltage to the cells for maximum efficiency. No other air cleaner does this. With other cleaners the voltage to the cells drops as they collect and efficiency decreases.

#### Reduces Operating Cost

- Uses only 15 watts compared to 35-45 watts required by other electronic air cleaners.
- Requires less energy than pleated media filters or washable electrostatic filters. These restrict airflow as they collect and increase the load on the heating and air conditioning motor.

#### Eliminates Guess Work in Service With A special Monitor Circuit

- Checks air cleaner performance continuously.
- Eliminates nuisance service calls.
- Monitor light pinpoints any problem in just a few minutes by telephone. Ends wasted service calls.

#### 100% Tested

- Each air cleaner is individually tested and operated.

### NO OTHER AIR CLEANER OFFERS ALL THESE ADVANTAGES

CA-1000



CA-1400  
CA-2000

CA-1620  
CA-2020

PATENT #4559594

Model	Capacity CFM	Cabinet Dimensions	Tons Cooling
CA-1000	1,000	13" x 20"	2 <sup>1/2</sup>
CA-1620	1,200	16" x 20"	3
CA-1400	1,400	16" x 25"	3 <sup>1/2</sup>
CA-2020	1,400	20" x 20"	3 <sup>1/2</sup>
CA-2000	2,000	20" x 25"	5

All Cabinets 6 5/8" Deep

PATENT #4559594

## ADAMS CLEANAIRE® CENTRAL SYSTEM RETURN GRILL ELECTRONIC AIR CLEANER

For homes, condominiums, apartments, mobile homes and applications where there is a common return grill rather than separate return air ducts from each room, the RG-1000 fits the bill. Larger homes with more than one return grill may require an additional return grill air cleaner, but will find that this improves the air quality even more.

CFM (Approx. Min.)	400
(Approx. Max.)	1,000
Furnace Output (Approx. Max.)	100,000 BTUH
Tons of Cooling (Approx. Max.)	2 <sup>1/2</sup> tons

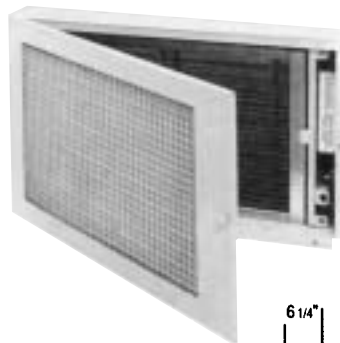

RG-1000  
PATENT #4559594

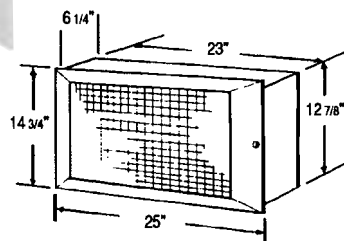

# Electronic Air Cleaner



## SELF-CONTAINED CEILING MOUNT ELECTRONIC AIR CLEANER



### CLEANS AIR BETTER

- Maintains constant output voltage to the cell for maximum efficiency. With other cleaners the voltage to the cells drops as it collects and efficiency decreases dramatically.

### QUIETER PERFORMANCE

- Less air turbulence than flush mount units makes Cleanaire® quieter and gives higher capacity.

### FITS MORE APPLICATIONS

- Low profile design requires only 8-1/2 inches above the T-Bar and will fit applications that others may not. Only 4 inches extend below the T-Bar ceiling.

### 100% TESTED

- Each air cleaner is individually tested and operated.

### REDUCES HEATING AND COOLING COSTS

- Heating and cooling costs can be reduced from 20-40% annually with Adams Cleanaire®. Why exhaust dirty air only to bring in outdoor polluted air from someone else's business. By cleaning the indoor air with Cleanaire®, introduction of outside air can be reduced to 1/3 of the minimum recommended 30 cfm per person. With 2/3 less air that must be heated or cooled, you save money.

### COMMON APPLICATIONS

- The removal of smoke from the air in bars, lounges, restaurants, bowling alleys, welding shops, kitchens, club rooms, offices, computer rooms and a variety of applications.

### HOW CLEANAIRE® WORKS

- A three-speed fan draws air through the center intake (1), metal mesh prefilter (2), electronic cell (3), and activated carbon after-filter (4). Cleanaire® removes airborne pollutants such as dust, dirt, pollen, tobacco smoke and cooking smoke. Then it distributes the clean air evenly through four adjustable louvers.

SPECIFICATIONS		
		CA-1000T
FAN SPEEDS	C.F.M.	EFFICIENCY
Low	600	93%
Medium	800	88%
High	1000	85%
Unit Weight	64 Lbs.	
Shipping Weight	73 Lbs.	
Dimensions	Width	Depth
	23" x 23" x 12 1/2"	
Electrical Information	120V	60 Hz

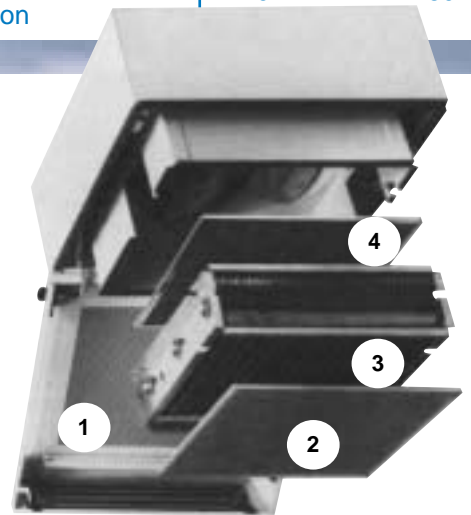

## PORTABLE ELECTRONIC AIR CLEANER

This Cleanaire® electronic air cleaner cleans the air in enclosed spaces such as homes or offices. A built-in fan draws air through an electronic cell and activated carbon filter to remove dust, lint, pollen, tobacco smoke, cooking smoke, and household odors.

Removes up to 95% of the dust, dirt, smoke, and pollen from the air you breathe.

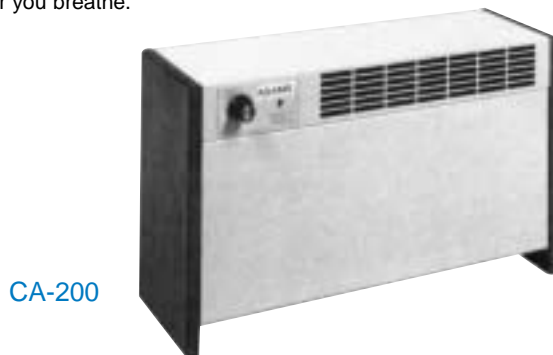

CA-200

CA-200	
C.F.M.	
Fan Speed	100 - 200
Cleaning Area	250 sq. ft. 8' Ceiling
Unit Weight	32 Lbs.
Dimensions	22 7/8" x 13 1/2" x 7 1/2"

# ADAMS HOME-GARD

The economical alternative  
to Electronic Air Cleaning

## HOME-GARD MEDIA-TYPE CENTRAL SYSTEM MODEL

### FEATURES:

- **Completely Disposable Filter** - Factory assembled replacement filter makes changing the filter clean, quick and easy. Throw the old one away and replace with a new one in seconds. No messy disassembly of the old media and reassembly of parts on the new.
- **Convertible** - Can be easily upgraded to full electronic air cleaner at an affordable price. The electronic filter fits in the same cabinet. ( EXCEPT CA - 2000 MF)
- **Standard Pre-filter** - Comes with washable, permanent lint screen to remove large particles
- **High Efficiency** - Removes 99% of pollens and spores and up to 90% of the dust and dirt.
- **Low Resistance** - Big on performance but low air flow resistance.
- **Horizontal Pleats** - More efficient pleats take more dirt out of the air than units with more pleats.
- **Charcoal Filter** - Optional charcoal filter available in place of lint screen.
- **Easier Installation** - Cheaper, faster and easier to install with pre-drilled, bendable tabs. No cutting, drilling or trimming is necessary.

### BENEFITS:

- **HEALTH** - Allergy sufferers may find the new Home-gard to be especially beneficial because it takes out so many of the things that bother them.
- **COMFORT** - Nor will you suffer the discomfort of stale, polluted air. Relax and enjoy the freshness that clean air brings you.

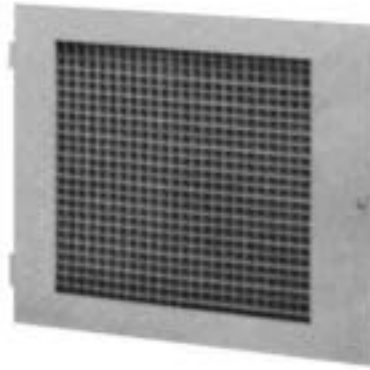

RG-1400 MF  
RG-2000 MF



CA-1625 MF  
CA-2025 MF

## SPECIFICATIONS

MODEL NUMBER	CAPACITY CFM	SHIPPING WEIGHT	FURNACE OUTPUT (MAXIMUM)	TONS OF COOLING (MAXIMUM)
CA-2000 MF	2000	14	200,00 BTU	5 TONS
CA-1625 MF RG-1400 MF	1400	16	140,00 BTU	3.5 TONS
CA-2025 MF RG-2000 MF	2000	18	200,00 BTU	5 TONS

\*Media filter classified by Underwriters Laboratories, Inc., for flammability only. Class 2.

Form No. CA-01-5m

Distributed by



Printed in U.S.A.

# ADAMS

Manufacturing Company

9790 Midwest Ave. • Cleveland, Ohio 44125

Telephone (216) 587-6801

FAX (216) 587-6807