

REV	NOTES	DATE

Notes:

1. Oil Type: Mineral
2. Tube ends must be plugged.
3. See ADS-5241-01 for cleanliness of refrigerant containing components.

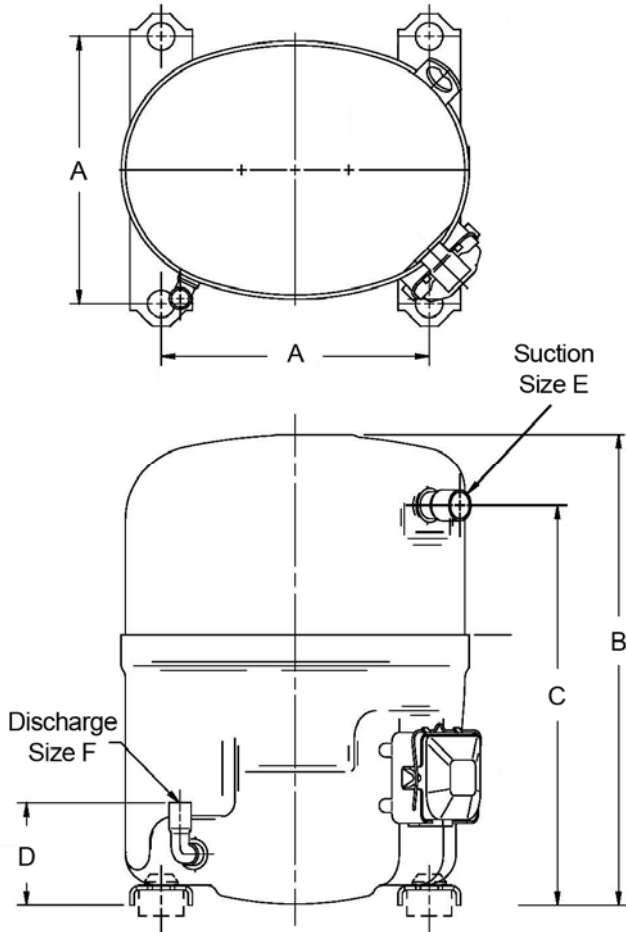

Unless otherwise specified all dimensions are in inches:

Tolerances

Fractional: +/- 1/32
 Angular: +1 degree; -3 degrees

Manufacturer	Manufacturer's Model Number	BOM No.	Capacity (BTUH)	Type	Refrigerant	Input Voltage (V)	No. of Phases	Freq. (Hz.)	Rated Load Current (A)	Max. Continuous Current (A)	Locked Rotor Current (A)
Bristol	H22J25BABCA	770006	24,214	Recip.	R-22	208/230	1	60	9.6	19.0	61.0
Start Capacitor (MFD / V)	Start Relay	Run Capacitor (MFD / V)	Crankcase Heater Included ?	Recommended Crankcase Heater Wattage (W)	Suction Line Height (in.) C	Suction Line Size (in.) E	Discharge Line Height (in.) D	Discharge Line Size (in.) F	Overall Compressor Height (in.) B	Mounting Base Dimensions (in. X in.) A	UL File No.
145-175/250	3ARR3*3T*	35/370	Yes	30	11-3/4	3/4	2-7/8	1/2	14	7-1/2 x 7-1/2	SA5470

Drawn By: DGR 8/30/10
 Reviewed By: ESP 9/16/10
 Date:

RHEEM CONFIDENTIAL INFORMATION. NO REVISION TO DESIGN, MATERIAL, TOOLING OR PROCESS IS ACCEPTABLE WITHOUT PRIOR APPROVAL FROM RHEEM THROUGH A REVISED ENGINEERING SPECIFICATION AND A RESAMPLING OF PARTS. THE SUPPLIER IS RESPONSIBLE FOR NOTIFYING RHEEM PARTS DEPARTMENT AND PURCHASING DEPARTMENTS IN WRITING OF ANY CHANGES AFFECTING PRODUCT QUALITY, PERFORMANCE, RELIABILITY, PACKAGING, DELIVERY OR WORKMANSHIP. ANY DOCUMENTS REFERRED TO ON THIS DRAWING ARE INCLUDED IN THE SPECIFICATIONS FOR THIS COMPONENT.



Parts Engineering

Compressor

55-25200-42S