



BrassCraft®

Gas Appliance & Water Heater Connectors

Better engineering, better selection, better results

THIS IS OUR CRAFT.®

WATER SUPPLIES

GAS PRODUCTS

WATER HEATER CONNECTORS

FITTINGS

REPAIR PARTS



THIS IS OUR CRAFT.®

For the everyday, hardworking craftsman on the job seeking reliability, BrassCraft® is the brand of plumbing products you rely on because it offers the highest quality plumbing products manufactured today.

Our products are designed with the pro in mind, never losing sight of what they really need to get the job done right the first time. We stand behind our products because we understand reputation and reliability are the only things that matter when the job is finished.

For over 70 years, we have led the product development, innovation and manufacturing of rough plumbing products.

Our clearly illustrated, easy-to-use catalogs are an important part of the BrassCraft leadership tradition. BrassCraft catalogs make finding and ordering the right plumbing products fast and simple.

WATER SUPPLIES

An invaluable, one-stop resource for plumbing professionals.

- Supply Stops
- Water Connectors
- Supply Kits
- Risers
- Fittings
- Special Finish

GAS APPLIANCE & WATER HEATER

A complete source for BrassCraft stainless steel gas connectors.

- Gas Connectors
- Water Heater Connectors
- Gas Valves
- Excess Flow Valves
- Tankless Service Valves
- Installation Kits

BRASS FITTINGS

A comprehensive catalog featuring a full line of reliable, easy-to-install fittings and products.

- Flare
- Compression
- CPVC
- Iron Pipe
- Hose Barb
- Garden Hose
- Drain/Shut-off Cocks
- Needle & Humidifier Valves

GAS APPLIANCE & WATER HEATER CONNECTORS

Table of Contents

BrassCraft®

Gas Connectors	4-22	Water Heater Connectors	34-42
Installation Kits	23-26	Point of Purchase	43
Gas Ball Valves	27-29	Specifications	44-52
Gas Fittings.....	30-33	Index	53-58

BrassCraft®

American-Made Quality

Founded in 1946 by Robert Zell in Detroit, Michigan, Brasscraft Manufacturing Company pioneered the one-piece, water shut-off valve and the flexible, one-piece supply line. Today these products have become the industry standard for residential and commercial plumbing projects. With facilities across the U.S., Brasscraft Mfg. Co. continues to invest in the most advanced design and manufacturing technologies to create the next generation of high-value plumbing products.



State-of-the-Art Engineering and Manufacturing

In the competitive environment of manufacturing, we know that we must meet your specifications for cost and quality. Everything we make is engineered for efficient equipment utilization and quality checked to exacting standards. This commitment to quality parts manufactured to the highest standards in tolerance and finish, has earned us our reputation for excellence.

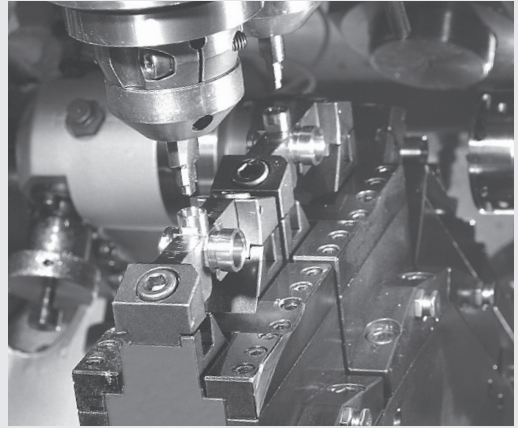

Compliant Solutions for the 2014 Low-lead Law

Federal Public Law 111-380 prohibits the sale of plumbing fixtures with a wetted surface area containing more than a weighted average of 0.25% lead. This law virtually eliminates the lead content of pipes, pipe fittings, plumbing fittings and fixtures intended to convey or dispense water for drinking or cooking.

Brasscraft Manufacturing Co. offers a comprehensive range of compliant products including water heater connectors and tankless service valves.

Look for the checkmark  on packaging to verify that the product meets the no-lead legislation requirements.

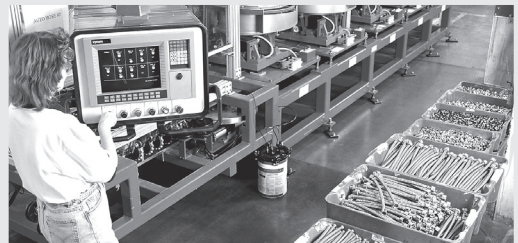

The Latest Technology

When it comes to technology, Brasscraft Mfg. Co. has consistently led the industry. We understand the benefits of electronic commerce, and are constantly striving to implement the latest technologies to serve you better.



EDI System

Saves time and helps ensure order accuracy by electronic order submission through our EDI (Electronic Data Interchange) system.

SureCount™ Verification

Our SureCount™ shipping verification system improves efficiency in the distribution stream and helps reduce your receiving costs. Using state-of-the-art bar code technology, we verify outbound shipments to help eliminate the need to double-check the shipment, saving you time and money.

ROA Interface

BrassCraft's Remote Order Access system helps enable you to:

- Perform order entry and confirmation
- Check order status and ship dates
- Access invoices and packing slips
- Print packing lists
- Track shipments
- View on-line proof of delivery

Interactive Web

The streamlined, user-friendly site provides detailed information on the growing range of BrassCraft® plumbing supplies. Our website can be used with most handheld devices including feature phones, smart phones and a wide range of tablet computers.

The Professional's Choice®

When it comes to customized products to meet code or job requirements, Brasscraft Mfg. Co. offers a wide range of stop variations including metal stems, lock shields, stuffing boxes, and handle options. So when you need water supply products for any project,

small or large, specify the brand that professionals worldwide have trusted for over 70 years — BrassCraft®.

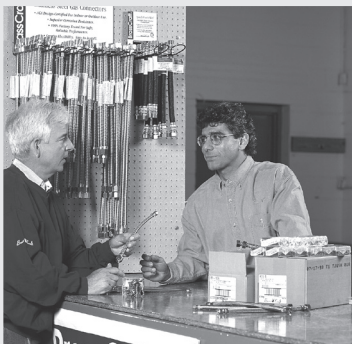

The Best Service in the Industry

What good are the best products in the industry without the best service? We match our high manufacturing standards with an equally high standard for customer service. When you call Brasscraft Mfg. Co., you're our number one priority. Our sales and service team is ready to

answer your questions and fill your orders promptly and courteously.

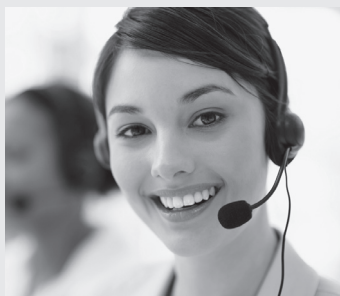

Part Numbering System

Example:



C	S	S	C	5	4	R	-	4	8
Type				Size and Style				Length	
Coated Stainless Steel – 1/2" ID (5/8" OD) Tube				Safety+PLUS® Valve – 1/2" FIP (3/4" MIP) Inlet x 1/2" MIP Outlet				48" Nominal Length	

CSSC

Connector Type

CSSB	Coated Stainless Steel - 3/4" ID (7/8" OD) Tube
CSSC	Coated Stainless Steel - 1/2" ID (5/8" OD) Tube
CSSD	Coated Stainless Steel - 3/8" ID (1/2" OD) Tube
CSSL	Coated Stainless Steel - 1/4" ID (3/8" OD) Tube
CSST	Coated Stainless Steel - 1/4" ID (3/8" OD) Tube, Fine Thread Adapter Included

Black Connectors:

BCSSD	Black Coated Stainless Steel - 3/8" ID (1/2" OD) Tube
BCSSL	Black Coated Stainless Steel - 1/4" ID (3/8" OD) Tube

54R

Size and Style

End Fitting/Valve Size and Style

Fittings:

- 1 3/4" MIP Straight (tapped 1/2" FIP)
- 2 3/4" FIP Straight
- 3 3/4" FIP Elbow
- 4 1/2" MIP Straight (tapped 3/8" FIP)
- 5 1/2" FIP Straight
- 6 1/2" MIP (no tap)
- 7 3/8" MIP (tapped 1/8" FIP) Straight for CSSD and CSSL connectors only
- 8 3/8" FIP Straight for CSSD and CSSL connectors only
- 9 5/8" Female Flare Straight*
- 10 3/4" MIP Straight (tapped 1/2" Female Flare)*
- 11 1/2" MIP Straight (tapped 3/8" Female Flare)*
- 12 1" MIP Straight (tapped 3/4" FIP)
- 14 1" FIP Straight

Ball Valves:

- | | |
|----------|--|
| J | 3/4" FIP Straight |
| K | 1/2" FIP Straight |
| M | 1/2" FIP Straight (for CSSL connectors only) |
| P | 3/4" FIP Angle |

Note: "R" suffix denotes Safety+PLUS® valve

* Available in Safety+PLUS® only

48

Length

Nominal Connector Length in Inches

Standard Lengths: 12", 18", 24", 30", 36", 48", 60", and 72"

Nominal length includes adaptors. Connectors with Safety+PLUS® valves are approximately 1" longer.

Dimensional Data

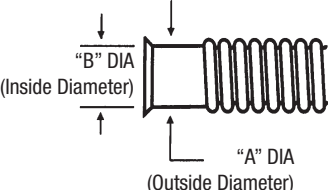

Connector Series	Size			
	CSSL	CSSD	CSSC	CSSB
"A" Diameter Nom OD Tube	3/8"	1/2"	5/8"	7/8"
"B" Diameter Nom ID Tube	1/4"	3/8"	1/2"	3/4"
Flare Nut Thread	3/8" OD Tube 5/8-18 Thread	1/2" OD Tube 3/4-16 Thread	5/8" OD Tube 15/16-16 Thread	7/8" OD Tube 1-1/16-16 Thread

Connector Flow Capacity – Per ANSI Z21.24 • CSA 6.10*

Connectors should be sized based upon the appliance gas consumption rate. Select a connector with a capacity equal to or greater than appliance input rate.

Connector Series	Nominal Connector (Inch)		STRAIGHT LENGTH CAPACITY - NATURAL GAS BTU PER HOUR							
	ID	OD	12"	18"	24"	30"	36"	48"	60"	72"
CSSL/BCSSL	1/4	3/8	48,000	43,800	40,000	36,400	33,400	28,300	24,900	23,100
CSSD/BCSSD	3/8	1/2	102,000	93,100	85,000	77,100	71,100	60,500	53,200	49,100
CSSC	1/2	5/8	180,000	164,200	150,000	136,000	125,000	106,000	93,200	86,000
CSSB	3/4	7/8	290,900	290,900	290,900	270,500	255,900	215,000	197,400	173,900

Connector Series	Nominal Connector (Inch)		STRAIGHT LENGTH CAPACITY - LPG (PROPANE) BTU PER HOUR							
	ID	OD	12"	18"	24"	30"	36"	48"	60"	72"
CSSL/BCSSL	1/4	3/8	76,800	70,080	64,000	58,240	53,440	45,280	39,840	36,960
CSSD/BCSSD	3/8	1/2	163,200	148,960	136,000	123,360	113,760	96,800	85,120	78,560
CSSC	1/2	5/8	288,000	262,720	240,000	217,600	200,000	169,600	149,120	137,600
CSSB	3/4	7/8	465,440	465,440	465,440	432,800	409,440	344,000	315,840	278,240

Connector Series	Nominal Connector (Inch)		STRAIGHT LENGTH CAPACITY - WATTS							
	ID	OD	0.31m	0.46m	0.61m	0.76m	0.92m	1.22m	1.53m	1.83m
CSSL/BCSSL	1/4	3/8	14,067	12,837	11,723	10,668	9,789	8,294	7,297	6,770
CSSD/BCSSD	3/8	1/2	29,893	27,285	24,911	22,596	20,837	17,731	15,591	14,390
CSSC	1/2	5/8	52,752	48,122	43,961	39,858	36,634	31,066	27,314	25,204
CSSB	3/4	7/8	85,254	85,254	85,254	79,276	74,997	63,010	57,852	50,965

0.64 Sp Gr, 1000 Btu per cu. ft. (37.2 MJ/m³) gas at 0.5 inch water column (124Pa) pressure drop. Per ANSI Z21.24 • CSA 6.10 for use with pressures not to exceed 1/2 PSI.

The flow capacities in the above charts are the minimum performance criterion established in ANSI Z21.24 • CSA 6.10 & ANSI Z21.75 • CSA 6.27.

Steel Fitting Suggested Torque Values – Per ANSI Z21.24 • CSA 6.10

Tube	Torque (inch pounds)**	
	Minimum	Maximum
CSSL	150	250
CSSD	200	390
CSSC	250	520
CSSB	400	780

**Torque range recommended to tighten gas connector

Safety+PLUS®

Coated Stainless Steel Gas Connectors with Patented Excess Flow Technology



Safety+PLUS® gas connectors combine advanced corrosion protection with state-of-the-art excess flow technology to deliver a superior gas connector for home and family.

The Safety+PLUS® excess flow valve (EFV) helps prevent gas fires and explosions due to line ruptures and disconnects at the appliance. When triggered, the Safety+PLUS® valve immediately restricts gas flow to a non-hazardous level (bypass flow) to help prevent a dangerous release of gas into the home.

Gas flow is controlled at the appliance where the problem occurred; the rest of the home's system will continue to function. Once the gas line is properly repaired, the valve automatically restores normal gas flow to the appliance.

- Automatic Valve Activation
- CSA Certified
- 100% Performance Tested
- Automatic Reset

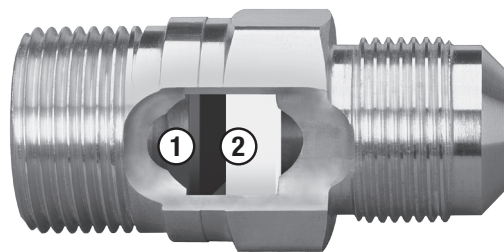

The Safety+PLUS® excess flow valve (EFV)

In the event of a rupture or disconnect, unrestricted gas flow forces the diaphragm (1) to firmly position itself against the seat (2). This immediate action restricts gas flow to help avert a hazardous build-up of gas.

PART NO.	UPC	DESCRIPTION	LENGTH	QTY	LBS
1/2" ID (5/8" OD) - MIP x MIP (cont.)					CSSC
CSSC11R-12	026613167992	3/4" MIP (1/2" FIP Tap) EFV x 3/4" MIP (1/2" FIP Tap)	12"	25	8.2
CSSC11R-18	026613168005	3/4" MIP (1/2" FIP Tap) EFV x 3/4" MIP (1/2" FIP Tap)	18"	25	8.2
CSSC11R-24	026613168012	3/4" MIP (1/2" FIP Tap) EFV x 3/4" MIP (1/2" FIP Tap)	24"	25	8.2
CSSC11R-30	026613168029	3/4" MIP (1/2" FIP Tap) EFV x 3/4" MIP (1/2" FIP Tap)	30"	25	8.2
CSSC14R-12	026613168043	3/4" MIP (1/2" FIP Tap) EFV x 1/2" MIP	12"	25	8.0
CSSC14R-18	026613168050	3/4" MIP (1/2" FIP Tap) EFV x 1/2" MIP	18"	25	8.0
CSSC14R-24	026613168067	3/4" MIP (1/2" FIP Tap) EFV x 1/2" MIP	24"	25	8.0
CSSC14R-30	026613168074	3/4" MIP (1/2" FIP Tap) EFV x 1/2" MIP	30"	25	8.0
CSSC14R-48	026613169187	3/4" MIP (1/2" FIP Tap) EFV x 1/2" MIP	48"	25	31.4
CSSC44R-12	026613168098	1/2" MIP EFV x 1/2" MIP	12"	25	7.7
CSSC44R-18	026613168104	1/2" MIP EFV x 1/2" MIP	18"	25	7.7
CSSC44R-24	026613168111	1/2" MIP EFV x 1/2" MIP	24"	25	7.7
CSSC44R-30	026613168128	1/2" MIP EFV x 1/2" MIP	30"	25	6.2
CSSC44R-48	026613168135	1/2" MIP EFV x 1/2" MIP	48"	25	13.9
CSSC44R-60	026613168142	1/2" MIP EFV x 1/2" MIP	60"	12	12.9
CSSC44R-72	026613169200	1/2" MIP EFV x 1/2" MIP	72"	12	18.7



1/2" ID (5/8" OD) - FIP x MIP					CSSC
CSSC21R-12	026613168159	3/4" FIP EFV x 3/4" MIP (1/2" FIP Tap)	12"	25	8.0
CSSC21R-18	026613168166	3/4" FIP EFV x 3/4" MIP (1/2" FIP Tap)	18"	25	8.0
CSSC21R-24	026613168173	3/4" FIP EFV x 3/4" MIP (1/2" FIP Tap)	24"	25	8.0
CSSC21R-30	026613168180	3/4" FIP EFV x 3/4" MIP (1/2" FIP Tap)	30"	25	8.0
CSSC21R-36	026613168197	3/4" FIP EFV x 3/4" MIP (1/2" FIP Tap)	36"	25	8.0
CSSC21R-48	026613168203	3/4" FIP EFV x 3/4" MIP (1/2" FIP Tap)	48"	25	8.0
CSSC24R-12	026613168227	3/4" FIP EFV x 1/2" MIP	12"	25	17.9
CSSC24R-18	026613168234	3/4" FIP EFV x 1/2" MIP	18"	25	17.9
CSSC24R-24	026613168241	3/4" FIP EFV x 1/2" MIP	24"	25	17.9
CSSC24R-30	026613168258	3/4" FIP EFV x 1/2" MIP	30"	25	17.9
CSSC24R-36	026613168265	3/4" FIP EFV x 1/2" MIP	36"	25	17.9
CSSC24R-48	026613168272	3/4" FIP EFV x 1/2" MIP	48"	25	17.9
CSSC24R-72	026613168289	3/4" FIP EFV x 1/2" MIP	72"	12	17.9
CSSC54R-12	026613168296	1/2" FIP (3/4" MIP) EFV x 1/2" MIP	12"	25	7.6
CSSC54R-18	026613168302	1/2" FIP (3/4" MIP) EFV x 1/2" MIP	18"	25	7.6
CSSC54R-24	026613168319	1/2" FIP (3/4" MIP) EFV x 1/2" MIP	24"	25	7.6
CSSC54R-30	026613168326	1/2" FIP (3/4" MIP) EFV x 1/2" MIP	30"	25	7.6
CSSC54R-48	026613167404	1/2" FIP (3/4" MIP) EFV x 1/2" MIP	48"	25	31.4
CSSC54R-60	026613167411	1/2" FIP (3/4" MIP) EFV x 1/2" MIP	60"	12	17.1
CSSC54R-72	026613168333	1/2" FIP (3/4" MIP) EFV x 1/2" MIP	72"	12	17.1



1/2" ID (5/8" OD) - FIP x FIP					CSSC
CSSC22R-12	026613168340	3/4" FIP EFV x 3/4" FIP	12"	25	13.3
CSSC22R-18	026613168357	3/4" FIP EFV x 3/4" FIP	18"	25	13.3
CSSC22R-24	026613168364	3/4" FIP EFV x 3/4" FIP	24"	25	13.3
CSSC22R-30	026613168371	3/4" FIP EFV x 3/4" FIP	30"	25	6.2
CSSC22R-48	026613169248	3/4" FIP EFV x 3/4" FIP	48"	25	31.0



If your requirements are not listed, please request a special quotation from the nearest BrassCraft office. UPC code will be provided at time of shipment.



PART NO.	UPC	DESCRIPTION	LENGTH	QTY	LBS
1/2" ID (5/8" OD) - FIP x FIP (cont.)					CSSC
CSSC22R-60	026613168388	3/4" FIP EFV x 3/4" FIP	60"	12	6.4
CSSC22R-72	026613169255	3/4" FIP EFV x 3/4" FIP	72"	12	18.7



1/2" ID (5/8" OD) - FIP X FIP					CSSC
CSSC55R-12	026613168395	1/2" FIP (3/4" MIP) EFV x 1/2" FIP	12"	25	17.4
CSSC55R-18	026613167428	1/2" FIP (3/4" MIP) EFV x 1/2" FIP	18"	25	21.0
CSSC55R-30	026613168401	1/2" FIP (3/4" MIP) EFV x 1/2" FIP	30"	25	23.0
CSSC55R-48	026613168418	1/2" FIP (3/4" MIP) EFV x 1/2" FIP	48"	25	13.7
CSSC55R-60	026613168425	1/2" FIP (3/4" MIP) EFV x 1/2" FIP	60"	12	13.3
CSSC55R-72	026613168432	1/2" FIP (3/4" MIP) EFV x 1/2" FIP	72"	12	13.3



1/2" ID (5/8" OD) - Female Flare x MIP					CSSC
CSSC91R-12	026613168449	5/8" OD Female Flare EFV x 3/4" MIP (1/2" FIP Tap)	12"	25	23.6
CSSC91R-18	026613168456	5/8" OD Female Flare EFV x 3/4" MIP (1/2" FIP Tap)	18"	25	23.6
CSSC91R-24	026613168463	5/8" OD Female Flare EFV x 3/4" MIP (1/2" FIP Tap)	24"	25	23.6
CSSC91R-30	026613168470	5/8" OD Female Flare EFV x 3/4" MIP (1/2" FIP Tap)	30"	25	23.6
CSSC91R-36	026613168487	5/8" OD Female Flare EFV x 3/4" MIP (1/2" FIP Tap)	36"	25	23.6
CSSC91R-48	026613168494	5/8" OD Female Flare EFV x 3/4" MIP (1/2" FIP Tap)	48"	25	7.4
CSSC91R-60	026613168500	5/8" OD Female Flare EFV x 3/4" MIP (1/2" FIP Tap)	60"	12	7.0
CSSC91R-72	026613168517	5/8" OD Female Flare EFV x 3/4" MIP (1/2" FIP Tap)	72"	12	7.0
CSSC94R-12	026613168524	5/8" OD Female Flare EFV x 1/2" MIP	12"	25	7.0
CSSC94R-18	026613168531	5/8" OD Female Flare EFV x 1/2" MIP	18"	25	7.0
CSSC94R-24	026613168548	5/8" OD Female Flare EFV x 1/2" MIP	24"	25	7.0
CSSC94R-30	026613168555	5/8" OD Female Flare EFV x 1/2" MIP	30"	25	7.0
CSSC94R-36	026613168562	5/8" OD Female Flare EFV x 1/2" MIP	36"	25	7.0
CSSC94R-48	026613168579	5/8" OD Female Flare EFV x 1/2" MIP	48"	25	7.0
CSSC94R-60	026613168586	5/8" OD Female Flare EFV x 1/2" MIP	60"	12	13.6
CSSC94R-72	026613168593	5/8" OD Female Flare EFV x 1/2" MIP	72"	12	13.6



1/2" ID (5/8" OD) - Gas Ball Valve w/Fem Flare x MIP					CSSC
CSSCJ4R-12 P20	026613168609	3/4" FIP Gas Ball Valve w/ 5/8" OD Female Flare EFV x 1/2" MIP	12"	20	13.6
CSSCJ4R-18 P20	026613168616	3/4" FIP Gas Ball Valve w/ 5/8" OD Female Flare EFV x 1/2" MIP	18"	20	13.6
CSSCJ4R-36 P20	026613168623	3/4" FIP Gas Ball Valve w/ 5/8" OD Female Flare EFV x 1/2" MIP	36"	20	39.0
CSSCJ4R-60 P12	026613168630	3/4" FIP Gas Ball Valve w/ 5/8" OD Female Flare EFV x 1/2" MIP	60"	12	38.1
CSSCJ4R-72 P12	026613168647	3/4" FIP Gas Ball Valve w/ 5/8" OD Female Flare EFV x 1/2" MIP	72"	12	38.1
CSSCK4R-12 P20	026613168654	1/2" FIP Gas Ball Valve w/ 5/8" OD Female Flare EFV x 1/2" MIP	12"	20	38.1
CSSCK4R-18 P20	026613168661	1/2" FIP Gas Ball Valve w/ 5/8" OD Female Flare EFV x 1/2" MIP	18"	20	38.1
CSSCK4R-60 P12	026613168678	1/2" FIP Gas Ball Valve w/ 5/8" OD Female Flare EFV x 1/2" MIP	60"	12	37.2

PART NO.	UPC	DESCRIPTION	LENGTH	QTY	LBS
3/8" ID (1/2" OD) - MIP x MIP					CSSD
CSSD44R-12	026613167527	1/2" MIP EFV x 1/2" MIP (3/8" FIP Tap)	12"	25	14.9
CSSD44R-18	026613168685	1/2" MIP EFV x 1/2" MIP (3/8" FIP Tap)	18"	25	3.4
CSSD44R-24	026613168692	1/2" MIP EFV x 1/2" MIP (3/8" FIP Tap)	24"	25	3.7
CSSD44R-30	026613168708	1/2" MIP EFV x 1/2" MIP (3/8" FIP Tap)	30"	25	11.5
CSSD44R-36	026613167596	1/2" MIP EFV x 1/2" MIP (3/8" FIP Tap)	36"	25	19.8
CSSD44R-48	026613169347	1/2" MIP EFV x 1/2" MIP (3/8" FIP Tap)	48"	25	24.4
CSSD44R-60	026613169354	1/2" MIP EFV x 1/2" MIP (3/8" FIP Tap)	60"	12	13.5
CSSD44R-72	026613167985	1/2" MIP EFV x 1/2" MIP (3/8" FIP Tap)	72"	12	14.8



3/8" ID (1/2" OD) - MIP x FIP					CSSD
CSSD45R-12	026613168715	1/2" MIP EFV x 1/2" FIP	12"	25	6.2
CSSD45R-18	026613168722	1/2" MIP EFV x 1/2" FIP	18"	25	3.1
CSSD45R-24	026613168739	1/2" MIP EFV x 1/2" FIP	24"	25	3.6
CSSD45R-30	026613168746	1/2" MIP EFV x 1/2" FIP	30"	25	3.9
CSSD45R-36	026613168753	1/2" MIP EFV x 1/2" FIP	36"	25	3.9
CSSD45R-48	026613168760	1/2" MIP EFV x 1/2" FIP	48"	25	4.5
CSSD45R-60	026613169149	1/2" MIP EFV x 1/2" FIP	60"	12	5.0
CSSD45R-72	026613169132	1/2" MIP EFV x 1/2" FIP	72"	12	5.6



3/8" ID (1/2" OD) - FIP x FIP					CSSD
CSSD55R-12	026613169125	1/2" FIP (3/4" MIP) EFV x 1/2" FIP	12"	25	11.4
CSSD55R-18	026613169118	1/2" FIP (3/4" MIP) EFV x 1/2" FIP	18"	25	11.4
CSSD55R-24	026613169101	1/2" FIP (3/4" MIP) EFV x 1/2" FIP	24"	25	17.1
CSSD55R-30	026613169095	1/2" FIP (3/4" MIP) EFV x 1/2" FIP	30"	25	18.8
CSSD55R-36	026613169088	1/2" FIP (3/4" MIP) EFV x 1/2" FIP	36"	25	18.8
CSSD55R-48	026613169071	1/2" FIP (3/4" MIP) EFV x 1/2" FIP	48"	25	18.8
CSSD55R-60	026613169064	1/2" FIP (3/4" MIP) EFV x 1/2" FIP	60"	12	18.8
CSSD55R-72	026613169057	1/2" FIP (3/4" MIP) EFV x 1/2" FIP	72"	12	18.8



3/8" ID (1/2" OD) - Gas Ball Valve w/Fem Flare x MIP					CSSD
CSSDK4R-12 P20	026613169040	1/2" FIP Gas Ball Valve w/ 1/2" OD Female Flare EFV x 1/2" MIP	12"	20	20.4
CSSDK4R-48 P20	026613169033	1/2" FIP Gas Ball Valve w/ 1/2" OD Female Flare EFV x 1/2" MIP	48"	20	20.4
CSSDK4R-60 P12	026613169026	1/2" FIP Gas Ball Valve w/ 1/2" OD Female Flare EFV x 1/2" MIP	60"	12	20.4
CSSDK4R-72 P12	026613169019	1/2" FIP Gas Ball Valve w/ 1/2" OD Female Flare EFV x 1/2" MIP	72"	12	20.4



1/4" ID (3/8" OD) - MIP x MIP					CSSL
CSSL44R-18	026613168999	1/2" MIP (3/8" FIP Tap) EFV x 1/2" MIP (3/8" FIP Tap)	18"	25	11.2
CSSL44R-30	026613168982	1/2" MIP (3/8" FIP Tap) EFV x 1/2" MIP (3/8" FIP Tap)	30"	25	8.4
CSSL44R-36	026613169408	1/2" MIP (3/8" FIP Tap) EFV x 1/2" MIP (3/8" FIP Tap)	36"	25	17.5
CSSL44R-48	026613169415	1/2" MIP (3/8" FIP Tap) EFV x 1/2" MIP (3/8" FIP Tap)	48"	25	20.5
CSSL44R-60	026613169422	1/2" MIP (3/8" FIP Tap) EFV x 1/2" MIP (3/8" FIP Tap)	60"	12	10.8
CSSL44R-72	026613169439	1/2" MIP (3/8" FIP Tap) EFV x 1/2" MIP (3/8" FIP Tap)	72"	12	11.9



If your requirements are not listed, please request a special quotation from the nearest BrassCraft office. UPC code will be provided at time of shipment.

PART NO.	UPC	DESCRIPTION	LENGTH	QTY	LBS
1/4" ID (3/8" OD) - MIP x FIP					CSSL
CSSL48R-12	026613168975	1/2" MIP (3/8" FIP Tap) EFV x 3/8" FIP	12"	25	10.6
CSSL48R-18	026613168968	1/2" MIP (3/8" FIP Tap) EFV x 3/8" FIP	18"	25	10.6
CSSL48R-30	026613168951	1/2" MIP (3/8" FIP Tap) EFV x 3/8" FIP	30"	25	10.6
CSSL48R-36	026613168944	1/2" MIP (3/8" FIP Tap) EFV x 3/8" FIP	36"	25	10.6
CSSL48R-60	026613168937	1/2" MIP (3/8" FIP Tap) EFV x 3/8" FIP	60"	12	19.1
CSSL48R-72	026613168920	1/2" MIP (3/8" FIP Tap) EFV x 3/8" FIP	72"	12	11.3



1/4" ID (3/8" OD) - FIP x MIP					CSSL
CSSL87R-12	026613168913	3/8" FIP (1/2" MIP) EFV x 3/8" MIP	12"	25	4.1
CSSL87R-18	026613168906	3/8" FIP (1/2" MIP) EFV x 3/8" MIP	18"	25	10.7
CSSL87R-24	026613168890	3/8" FIP (1/2" MIP) EFV x 3/8" MIP	24"	25	10.7
CSSL87R-30	026613168883	3/8" FIP (1/2" MIP) EFV x 3/8" MIP	30"	25	10.7
CSSL87R-36	026613168876	3/8" FIP (1/2" MIP) EFV x 3/8" MIP	36"	25	10.7
CSSL87R-72	026613168869	3/8" FIP (1/2" MIP) EFV x 3/8" MIP	72"	12	9.6



1/4" ID (3/8" OD) - FIP x FIP					CSSL
CSSL88R-12	026613168852	3/8" FIP (1/2" MIP) EFV x 3/8" FIP	12"	25	8.8
CSSL88R-18	026613168845	3/8" FIP (1/2" MIP) EFV x 3/8" FIP	18"	25	8.8
CSSL88R-30	026613168821	3/8" FIP (1/2" MIP) EFV x 3/8" FIP	30"	25	8.8
CSSL88R-36	026613168814	3/8" FIP (1/2" MIP) EFV x 3/8" FIP	36"	25	8.8
CSSL88R-60	026613168807	3/8" FIP (1/2" MIP) EFV x 3/8" FIP	60"	12	19.1
CSSL88R-72	026613168791	3/8" FIP (1/2" MIP) EFV x 3/8" FIP	72"	12	19.1





ProCoat®

Coated Stainless Steel Gas Connectors

The ProCoat® coating helps protect the stainless steel connector from corrosion due to prolonged exposure to harsh chemicals found in common household cleaning, plumbing repair and building products (ammonia, chlorine, solder flux and muriatic acid). Designed for indoor and outdoor use, ProCoat® is resistant to the harsh effects of UV rays and salt.

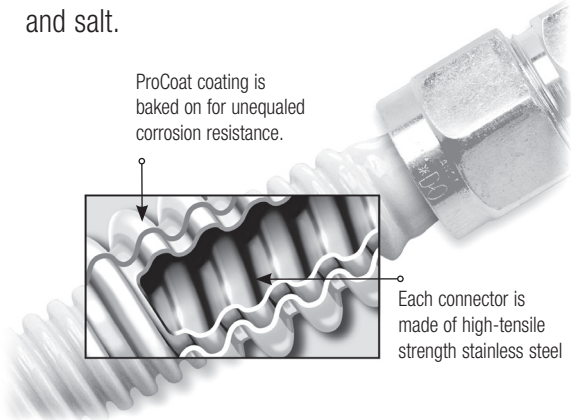

- Superior Corrosion Resistance
- Greater Strength & Flexibility
- Approved for Indoor & Outdoor Use
- 100% Leak Tested
- CSA Certified

Available in Black

See pages 22-23



PART NO.	UPC	DESCRIPTION	LENGTH	QTY	LBS
3/4" ID (7/8" OD) - MIP x MIP					CSSB
CSSB11-12	026613134949	3/4" MIP (1/2" FIP Tap) x 3/4" MIP (1/2" FIP Tap)	12"	10	10.3
CSSB11-18	026613134956	3/4" MIP (1/2" FIP Tap) x 3/4" MIP (1/2" FIP Tap)	18"	10	11.1
CSSB11-24	026613127682	3/4" MIP (1/2" FIP Tap) x 3/4" MIP (1/2" FIP Tap)	24"	10	12.1
CSSB11-30	026613134796	3/4" MIP (1/2" FIP Tap) x 3/4" MIP (1/2" FIP Tap)	30"	10	13.0
CSSB11-36	026613122809	3/4" MIP (1/2" FIP Tap) x 3/4" MIP (1/2" FIP Tap)	36"	10	14.1
CSSB11-48	026613130248	3/4" MIP (1/2" FIP Tap) x 3/4" MIP (1/2" FIP Tap)	48"	5	8.9
CSSB11-60	026613127699	3/4" MIP (1/2" FIP Tap) x 3/4" MIP (1/2" FIP Tap)	60"	5	9.2



3/4" ID (7/8" OD) - FIP x MIP					CSSB
CSSB1412-12	026613134642	1" FIP x 1" MIP (3/4" FIP Tap)	12"	10	12.5
CSSB1412-18	026613134635	1" FIP x 1" MIP (3/4" FIP Tap)	18"	10	13.2
CSSB1412-24	026613118482	1" FIP x 1" MIP (3/4" FIP Tap)	24"	10	14.2
CSSB1412-36	026613118499	1" FIP x 1" MIP (3/4" FIP Tap)	36"	10	16.3
CSSB21-12	026613134871	3/4" FIP x 3/4" MIP (1/2" FIP Tap)	12"	10	9.7
CSSB21-18	026613134888	3/4" FIP x 3/4" MIP (1/2" FIP Tap)	18"	10	10.4
CSSB21-24	026613118413	3/4" FIP x 3/4" MIP (1/2" FIP Tap)	24"	10	11.4
CSSB21-30	026613118437	3/4" FIP x 3/4" MIP (1/2" FIP Tap)	30"	10	12.5
CSSB21-36	026613118444	3/4" FIP x 3/4" MIP (1/2" FIP Tap)	36"	10	13.5
CSSB21-48	026613118451	3/4" FIP x 3/4" MIP (1/2" FIP Tap)	48"	5	8.8
CSSB21-60	026613118468	3/4" FIP x 3/4" MIP (1/2" FIP Tap)	60"	5	8.9
CSSB21-72	026613118475	3/4" FIP x 3/4" MIP (1/2" FIP Tap)	72"	5	10.0



If your requirements are not listed, please request a special quotation from the nearest BrassCraft office. UPC code will be provided at time of shipment.



PART NO.	UPC	DESCRIPTION	LENGTH	QTY	LBS
3/4" ID (7/8" OD) - FIP x FIP					CSSB
CSSB22-12	026613134901	3/4" FIP x 3/4" FIP	12"	10	9.0
CSSB22-18	026613134895	3/4" FIP x 3/4" FIP	18"	10	9.8
CSSB22-24	026613119304	3/4" FIP x 3/4" FIP	24"	10	10.8
CSSB22-30	026613133928	3/4" FIP x 3/4" FIP	30"	10	11.8
CSSB22-36	026613119311	3/4" FIP x 3/4" FIP	36"	10	12.8
CSSB22-48	026613119328	3/4" FIP x 3/4" FIP	48"	5	8.3
CSSB22-60	026613126319	3/4" FIP x 3/4" FIP	60"	5	8.6
CSSB22-72	026613120492	3/4" FIP x 3/4" FIP	72"	5	9.7



1/2" ID (5/8" OD) - MIP x MIP					CSSC
CSSC11-12	026613119830	3/4" MIP (1/2" FIP Tap) x 3/4" MIP (1/2" FIP Tap)	12"	25	20.6
CSSC11-18	026613112572	3/4" MIP (1/2" FIP Tap) x 3/4" MIP (1/2" FIP Tap)	18"	25	22.4
CSSC11-24	026613112589	3/4" MIP (1/2" FIP Tap) x 3/4" MIP (1/2" FIP Tap)	24"	25	24.4
CSSC11-30	026613118017	3/4" MIP (1/2" FIP Tap) x 3/4" MIP (1/2" FIP Tap)	30"	25	26.4
CSSC11-36	026613112596	3/4" MIP (1/2" FIP Tap) x 3/4" MIP (1/2" FIP Tap)	36"	25	28.1
CSSC11-48	026613112619	3/4" MIP (1/2" FIP Tap) x 3/4" MIP (1/2" FIP Tap)	48"	25	32.3
CSSC11-60	026613112626	3/4" MIP (1/2" FIP Tap) x 3/4" MIP (1/2" FIP Tap)	60"	12	17.6
CSSC11-72	026613112633	3/4" MIP (1/2" FIP Tap) x 3/4" MIP (1/2" FIP Tap)	72"	12	19.3
CSSC14-12	026613117706	3/4" MIP (1/2" FIP Tap) x 1/2" MIP	12"	25	19.3
CSSC14-18	026613112640	3/4" MIP (1/2" FIP Tap) x 1/2" MIP	18"	25	21.1
CSSC14-24	026613112657	3/4" MIP (1/2" FIP Tap) x 1/2" MIP	24"	25	23.1
CSSC14-30	026613112664	3/4" MIP (1/2" FIP Tap) x 1/2" MIP	30"	25	24.9
CSSC14-36	026613112398	3/4" MIP (1/2" FIP Tap) x 1/2" MIP	36"	25	26.6
CSSC14-48	026613112404	3/4" MIP (1/2" FIP Tap) x 1/2" MIP	48"	25	30.8
CSSC14-60	026613112671	3/4" MIP (1/2" FIP Tap) x 1/2" MIP	60"	12	16.9
CSSC14-72	026613112688	3/4" MIP (1/2" FIP Tap) x 1/2" MIP	72"	12	18.7
CSSC44-12	026613112947	1/2" MIP x 1/2" MIP	12"	25	17.8
CSSC44-18	026613112954	1/2" MIP x 1/2" MIP	18"	25	19.5
CSSC44-24	026613112381	1/2" MIP x 1/2" MIP	24"	25	21.5
CSSC44-30	026613112985	1/2" MIP x 1/2" MIP	30"	25	23.5
CSSC44-36	026613112367	1/2" MIP x 1/2" MIP	36"	25	25.2
CSSC44-48	026613112374	1/2" MIP x 1/2" MIP	48"	25	29.4
CSSC44-60	026613113012	1/2" MIP x 1/2" MIP	60"	12	16.2
CSSC44-72	026613113029	1/2" MIP x 1/2" MIP	72"	12	18.0



1/2" ID (5/8" OD) - MIP x FIP					CSSC
CSSC15-12	026613128115	3/4" MIP (1/2" FIP Tap) x 1/2" FIP	12"	25	18.7
CSSC15-18	026613121055	3/4" MIP (1/2" FIP Tap) x 1/2" FIP	18"	25	20.4
CSSC15-24	026613118802	3/4" MIP (1/2" FIP Tap) x 1/2" FIP	24"	25	22.5
CSSC15-30	026613128580	3/4" MIP (1/2" FIP Tap) x 1/2" FIP	30"	25	24.4
CSSC15-36	026613119335	3/4" MIP (1/2" FIP Tap) x 1/2" FIP	36"	25	26.1
CSSC15-48	026613118819	3/4" MIP (1/2" FIP Tap) x 1/2" FIP	48"	25	30.3
CSSC15-60	026613118826	3/4" MIP (1/2" FIP Tap) x 1/2" FIP	60"	12	16.6
CSSC15-72	026613119342	3/4" MIP (1/2" FIP Tap) x 1/2" FIP	72"	12	18.4

PART NO.	UPC	DESCRIPTION	LENGTH	QTY	LBS
1/2" ID (5/8" OD) - FIP x MIP					CSSC
CSSC21-12	026613112725	3/4" FIP x 3/4" MIP (1/2" FIP Tap)	12"	25	19.2
CSSC21-18	026613112718	3/4" FIP x 3/4" MIP (1/2" FIP Tap)	18"	25	21.0
CSSC21-24	026613112732	3/4" FIP x 3/4" MIP (1/2" FIP Tap)	24"	25	23.0
CSSC21-30	026613117942	3/4" FIP x 3/4" MIP (1/2" FIP Tap)	30"	25	24.9
CSSC21-36	026613112749	3/4" FIP x 3/4" MIP (1/2" FIP Tap)	36"	25	26.6
CSSC21-48	026613112756	3/4" FIP x 3/4" MIP (1/2" FIP Tap)	48"	25	30.8
CSSC21-60	026613112763	3/4" FIP x 3/4" MIP (1/2" FIP Tap)	60"	12	16.9
CSSC21-72	026613118833	3/4" FIP x 3/4" MIP (1/2" FIP Tap)	72"	12	18.6
CSSC24-12	026613121246	3/4" FIP x 1/2" MIP	12"	25	17.7
CSSC24-18	026613120713	3/4" FIP x 1/2" MIP	18"	25	19.5
CSSC24-24	026613112824	3/4" FIP x 1/2" MIP	24"	25	21.5
CSSC24-30	026613121710	3/4" FIP x 1/2" MIP	30"	25	23.5
CSSC24-36	026613112831	3/4" FIP x 1/2" MIP	36"	25	25.2
CSSC24-48	026613112848	3/4" FIP x 1/2" MIP	48"	25	29.4
CSSC24-60	026613112855	3/4" FIP x 1/2" MIP	60"	12	16.2
CSSC24-72	026613112862	3/4" FIP x 1/2" MIP	72"	12	17.9
CSSC54-12	026613113067	1/2" FIP x 1/2" MIP (3/8" FIP Tap)	12"	25	17.2
CSSC54-18	026613113050	1/2" FIP x 1/2" MIP (3/8" FIP Tap)	18"	25	19.0
CSSC54-24	026613113043	1/2" FIP x 1/2" MIP (3/8" FIP Tap)	24"	25	21.0
CSSC54-30	026613113036	1/2" FIP x 1/2" MIP (3/8" FIP Tap)	30"	25	22.9
CSSC54-36	026613112411	1/2" FIP x 1/2" MIP (3/8" FIP Tap)	36"	25	24.7
CSSC54-48	026613113074	1/2" FIP x 1/2" MIP (3/8" FIP Tap)	48"	25	28.8
CSSC54-60	026613113081	1/2" FIP x 1/2" MIP (3/8" FIP Tap)	60"	12	15.9
CSSC54-72	026613117959	1/2" FIP x 1/2" MIP (3/8" FIP Tap)	72"	12	17.7



1/2" ID (5/8" OD) - FIP x FIP					CSSC
CSSC22-12	026613119021	3/4" FIP x 3/4" FIP	12"	25	17.8
CSSC22-18	026613118680	3/4" FIP x 3/4" FIP	18"	25	19.6
CSSC22-24	026613112770	3/4" FIP x 3/4" FIP	24"	25	21.6
CSSC22-30	026613121086	3/4" FIP x 3/4" FIP	30"	25	23.5
CSSC22-36	026613112787	3/4" FIP x 3/4" FIP	36"	25	25.3
CSSC22-48	026613112794	3/4" FIP x 3/4" FIP	48"	25	29.5
CSSC22-60	026613112800	3/4" FIP x 3/4" FIP	60"	12	16.2
CSSC22-72	026613112817	3/4" FIP x 3/4" FIP	72"	12	18.0
CSSC25-12	026613122014	3/4" FIP x 1/2" FIP	12"	25	17.2
CSSC25-18	026613121154	3/4" FIP x 1/2" FIP	18"	25	19.0
CSSC25-24	026613118734	3/4" FIP x 1/2" FIP	24"	25	21.0
CSSC25-30	026613124216	3/4" FIP x 1/2" FIP	30"	25	22.9
CSSC25-36	026613112879	3/4" FIP x 1/2" FIP	36"	25	24.7
CSSC25-48	026613112886	3/4" FIP x 1/2" FIP	48"	25	28.8
CSSC25-60	026613112893	3/4" FIP x 1/2" FIP	60"	12	15.9
CSSC25-72	026613119007	3/4" FIP x 1/2" FIP	72"	12	17.7
CSSC55-12	026613113128	1/2" FIP x 1/2" FIP	12"	25	16.7
CSSC55-18	026613113111	1/2" FIP x 1/2" FIP	18"	25	18.5



If your requirements are not listed, please request a special quotation from the nearest BrassCraft office. UPC code will be provided at time of shipment.



PART NO.	UPC	DESCRIPTION	LENGTH	QTY	LBS
1/2" ID (5/8" OD) - FIP x FIP (cont.)					CSSC
CSSC55-24	026613113104	1/2" FIP x 1/2" FIP	24"	25	20.5
CSSC55-30	026613113098	1/2" FIP x 1/2" FIP	30"	25	22.4
CSSC55-36	026613112428	1/2" FIP x 1/2" FIP	36"	25	24.1
CSSC55-48	026613113135	1/2" FIP x 1/2" FIP	48"	25	28.3
CSSC55-60	026613113159	1/2" FIP x 1/2" FIP	60"	12	15.7
CSSC55-72	026613113166	1/2" FIP x 1/2" FIP	72"	12	17.4
CSSC23-24	026613117980	3/4" FIP x 3/4" FIP Elbow	24"	25	24.9
CSSC23-36	026613121093	3/4" FIP x 3/4" FIP Elbow	36"	25	28.5
CSSC23-48	026613120768	3/4" FIP x 3/4" FIP Elbow	48"	25	32.7
CSSC23-72	026613117270	3/4" FIP x 3/4" FIP Elbow	72"	12	18.9

1/2" ID (5/8" OD) - MIP x Gas Ball Valve					CSSC
CSSC1J-12	026613128214	3/4" MIP (1/2" FIP Tap) x 3/4" FIP Gas Ball Valve	12"	20	22.9
CSSC1J-18	026613121185	3/4" MIP (1/2" FIP Tap) x 3/4" FIP Gas Ball Valve	18"	20	24.5
CSSC1J-24	026613112695	3/4" MIP (1/2" FIP Tap) x 3/4" FIP Gas Ball Valve	24"	20	26.1
CSSC1J-30	026613121383	3/4" MIP (1/2" FIP Tap) x 3/4" FIP Gas Ball Valve	30"	20	27.7
CSSC1J-36	026613112701	3/4" MIP (1/2" FIP Tap) x 3/4" FIP Gas Ball Valve	36"	20	29.1
CSSC1J-48	026613121192	3/4" MIP (1/2" FIP Tap) x 3/4" FIP Gas Ball Valve	48"	20	32.3
CSSC1J-60	026613121697	3/4" MIP (1/2" FIP Tap) x 3/4" FIP Gas Ball Valve	60"	12	21.3
CSSC1J-72	026613121703	3/4" MIP (1/2" FIP Tap) x 3/4" FIP Gas Ball Valve	72"	12	23.1
CSSC4J-12	026613121390	1/2" MIP x 3/4" FIP Gas Ball Valve	12"	20	21.8
CSSC4J-18	026613113197	1/2" MIP x 3/4" FIP Gas Ball Valve	18"	20	23.4
CSSC4J-24	026613113203	1/2" MIP x 3/4" FIP Gas Ball Valve	24"	20	25.0
CSSC4J-30	026613121307	1/2" MIP x 3/4" FIP Gas Ball Valve	30"	20	26.5
CSSC4J-36	026613113210	1/2" MIP x 3/4" FIP Gas Ball Valve	36"	20	27.9
CSSC4J-48	026613113227	1/2" MIP x 3/4" FIP Gas Ball Valve	48"	20	31.2
CSSC4J-60	026613120409	1/2" MIP x 3/4" FIP Gas Ball Valve	60"	12	20.6
CSSC4J-72	026613121406	1/2" MIP x 3/4" FIP Gas Ball Valve	72"	12	22.4
CSSC4K-12	026613121109	1/2" MIP x 1/2" FIP Gas Ball Valve	12"	20	20.8
CSSC4K-18	026613113234	1/2" MIP x 1/2" FIP Gas Ball Valve	18"	20	22.4
CSSC4K-24	026613113241	1/2" MIP x 1/2" FIP Gas Ball Valve	24"	20	24.0
CSSC4K-30	026613120263	1/2" MIP x 1/2" FIP Gas Ball Valve	30"	20	25.5
CSSC4K-36	026613113258	1/2" MIP x 1/2" FIP Gas Ball Valve	36"	20	27.0
CSSC4K-48	026613113265	1/2" MIP x 1/2" FIP Gas Ball Valve	48"	20	30.2
CSSC4K-60	026613171258	1/2" MIP x 1/2" FIP Gas Ball Valve	60"	12	20.1

1/2" ID (5/8" OD) - MIP x Gas Ball Valve, Angle					CSSC
CSSC1P-12	026613121673	3/4" MIP (1/2" FIP Tap) x 3/4" FIP Gas Ball Valve - Angle	12"	20	23.4
CSSC1P-18	026613121680	3/4" MIP (1/2" FIP Tap) x 3/4" FIP Gas Ball Valve - Angle	18"	20	25.0
CSSC1P-24	026613121208	3/4" MIP (1/2" FIP Tap) x 3/4" FIP Gas Ball Valve - Angle	24"	20	26.6
CSSC1P-30	026613121215	3/4" MIP (1/2" FIP Tap) x 3/4" FIP Gas Ball Valve - Angle	30"	20	28.2
CSSC1P-36	026613118604	3/4" MIP (1/2" FIP Tap) x 3/4" FIP Gas Ball Valve - Angle	36"	20	29.6
CSSC1P-48	026613120126	3/4" MIP (1/2" FIP Tap) x 3/4" FIP Gas Ball Valve - Angle	48"	20	32.8
CSSC1P-60	026613121222	3/4" MIP (1/2" FIP Tap) x 3/4" FIP Gas Ball Valve - Angle	60"	12	21.6
CSSC4P-12	026613121895	1/2" MIP x 3/4" FIP Gas Ball Valve - Angle	12"	20	22.2

PART NO.	UPC	DESCRIPTION	LENGTH	QTY	LBS
1/2" ID (5/8" OD) - MIP x Gas Ball Valve, Angle (cont.)					CSSC
CSSC4P-18	026613121314	1/2" MIP x 3/4" FIP Gas Ball Valve - Angle	18"	20	23.8
CSSC4P-24	026613121338	1/2" MIP x 3/4" FIP Gas Ball Valve - Angle	24"	20	25.4
CSSC4P-30	026613121345	1/2" MIP x 3/4" FIP Gas Ball Valve - Angle	30"	20	26.9
CSSC4P-36	026613113272	1/2" MIP x 3/4" FIP Gas Ball Valve - Angle	36"	20	28.4
CSSC4P-48	026613113289	1/2" MIP x 3/4" FIP Gas Ball Valve - Angle	48"	20	31.6
CSSC4P-60	026613121352	1/2" MIP x 3/4" FIP Gas Ball Valve - Angle	60"	12	20.9
CSSC4P-72	026613121321	1/2" MIP x 3/4" FIP Gas Ball Valve - Angle	72"	12	22.7



1/2" ID (5/8" OD) - FIP x Gas Ball Valve					CSSC
CSSC2J-12	026613121253	3/4" FIP x 3/4" FIP Gas Ball Valve	12"	20	21.8
CSSC2J-18	026613112909	3/4" FIP x 3/4" FIP Gas Ball Valve	18"	20	23.4
CSSC2J-24	026613112916	3/4" FIP x 3/4" FIP Gas Ball Valve	24"	20	25.0
CSSC2J-30	026613121260	3/4" FIP x 3/4" FIP Gas Ball Valve	30"	20	26.5
CSSC2J-36	026613112923	3/4" FIP x 3/4" FIP Gas Ball Valve	36"	20	27.9
CSSC2J-48	026613112930	3/4" FIP x 3/4" FIP Gas Ball Valve	48"	20	31.2
CSSC2J-60	026613120720	3/4" FIP x 3/4" FIP Gas Ball Valve	60"	12	20.6
CSSC2J-72	026613121277	3/4" FIP x 3/4" FIP Gas Ball Valve	72"	12	22.4



1/2" ID (5/8" OD) - FIP x Gas Ball Valve, Angle					CSSC
CSSC2P-12	026613121888	3/4" FIP x 3/4" FIP Gas Ball Valve - Angle	12"	20	22.0
CSSC2P-18	026613119496	3/4" FIP x 3/4" FIP Gas Ball Valve - Angle	18"	20	23.8
CSSC2P-24	026613119502	3/4" FIP x 3/4" FIP Gas Ball Valve - Angle	24"	20	25.4
CSSC2P-30	026613144092	3/4" FIP x 3/4" FIP Gas Ball Valve - Angle	30"	20	25.4
CSSC2P-36	026613119076	3/4" FIP x 3/4" FIP Gas Ball Valve - Angle	36"	20	28.4
CSSC2P-48	026613121284	3/4" FIP x 3/4" FIP Gas Ball Valve - Angle	48"	20	31.6
CSSC2P-60	026613119519	3/4" FIP x 3/4" FIP Gas Ball Valve - Angle	60"	12	20.9



3/8" ID (1/2" OD) - MIP x MIP					CSSD
CSSD44-12	026613113333	1/2" MIP (3/8" FIP Tap) x 1/2" MIP (3/8" FIP Tap)	12"	25	13.1
CSSD44-18	026613112466	1/2" MIP (3/8" FIP Tap) x 1/2" MIP (3/8" FIP Tap)	18"	25	14.4
CSSD44-24	026613112336	1/2" MIP (3/8" FIP Tap) x 1/2" MIP (3/8" FIP Tap)	24"	25	15.9
CSSD44-30	026613112343	1/2" MIP (3/8" FIP Tap) x 1/2" MIP (3/8" FIP Tap)	30"	25	17.5
CSSD44-36	026613112329	1/2" MIP (3/8" FIP Tap) x 1/2" MIP (3/8" FIP Tap)	36"	25	19.1
CSSD44-48	026613112350	1/2" MIP (3/8" FIP Tap) x 1/2" MIP (3/8" FIP Tap)	48"	25	22.2
CSSD44-60	026613113340	1/2" MIP (3/8" FIP Tap) x 1/2" MIP (3/8" FIP Tap)	60"	12	12.3
CSSD44-72	026613113357	1/2" MIP (3/8" FIP Tap) x 1/2" MIP (3/8" FIP Tap)	72"	12	13.7
CSSD47-12	026613126005	1/2" MIP (3/8" FIP Tap) x 3/8" MIP	12"	25	12.3
CSSD47-18	026613131566	1/2" MIP (3/8" FIP Tap) x 3/8" MIP	18"	25	13.5
CSSD47-24	026613128436	1/2" MIP (3/8" FIP Tap) x 3/8" MIP	24"	25	15.0
CSSD47-30	026613134154	1/2" MIP (3/8" FIP Tap) x 3/8" MIP	30"	25	16.7
CSSD47-36	026613130217	1/2" MIP (3/8" FIP Tap) x 3/8" MIP	36"	25	18.2
CSSD47-48	026613118529	1/2" MIP (3/8" FIP Tap) x 3/8" MIP	48"	25	21.3
CSSD47-60	026613130873	1/2" MIP (3/8" FIP Tap) x 3/8" MIP	60"	12	11.8
CSSD47-72	026613144108	1/2" MIP (3/8" FIP Tap) x 3/8" MIP	72"	12	12.0
CSSD77-12	026613121604	3/8" MIP x 3/8" MIP	12"	25	11.4



If your requirements are not listed, please request a special quotation from the nearest BrassCraft office. UPC code will be provided at time of shipment.



PART NO.	UPC	DESCRIPTION	LENGTH	QTY	LBS
3/8" ID (1/2" OD) - MIP x MIP (cont.)					CSSD
CSSD77-18	026613127859	3/8" MIP x 3/8" MIP	18"	25	12.6
CSSD77-24	026613120829	3/8" MIP x 3/8" MIP	24"	25	14.1
CSSD77-30	026613130279	3/8" MIP x 3/8" MIP	30"	25	15.8
CSSD77-36	026613120393	3/8" MIP x 3/8" MIP	36"	25	17.3
CSSD77-48	026613118987	3/8" MIP x 3/8" MIP	48"	25	20.4
CSSD77-60	026613144115	3/8" MIP x 3/8" MIP	60"	12	11.0
CSSD77-72	026613144122	3/8" MIP x 3/8" MIP	72"	12	13.0



3/8" ID (1/2" OD) - FIP x MIP					CSSD
CSSD54-12	026613112473	1/2" FIP x 1/2" MIP (3/8" FIP Tap)	12"	25	12.8
CSSD54-18	026613112480	1/2" FIP x 1/2" MIP (3/8" FIP Tap)	18"	25	13.9
CSSD54-24	026613112497	1/2" FIP x 1/2" MIP (3/8" FIP Tap)	24"	25	15.4
CSSD54-30	026613113401	1/2" FIP x 1/2" MIP (3/8" FIP Tap)	30"	25	17.2
CSSD54-36	026613112503	1/2" FIP x 1/2" MIP (3/8" FIP Tap)	36"	25	18.6
CSSD54-48	026613112510	1/2" FIP x 1/2" MIP (3/8" FIP Tap)	48"	25	21.8
CSSD54-60	026613113418	1/2" FIP x 1/2" MIP (3/8" FIP Tap)	60"	12	12.1
CSSD54-72	026613113425	1/2" FIP x 1/2" MIP (3/8" FIP Tap)	72"	12	13.5
CSSD57-12	026613125930	1/2" FIP x 3/8" MIP	12"	25	11.8
CSSD57-18	026613144139	1/2" FIP x 3/8" MIP	18"	25	13.0
CSSD57-30	026613144146	1/2" FIP x 3/8" MIP	30"	25	16.0
CSSD57-48	026613125978	1/2" FIP x 3/8" MIP	48"	25	23.5
CSSD57-60	026613144153	1/2" FIP x 3/8" MIP	60"	12	11.0
CSSD57-72	026613144160	1/2" FIP x 3/8" MIP	72"	12	13.0
CSSD48-12	026613127538	1/2" MIP (3/8" FIP Tap) x 3/8" FIP	12"	25	11.7
CSSD48-18	026613169491	1/2" MIP (3/8" FIP Tap) x 3/8" FIP	18"	25	11.7
CSSD48-24	026613129068	1/2" MIP (3/8" FIP Tap) x 3/8" FIP	24"	25	14.5
CSSD48-30	026613130484	1/2" MIP (3/8" FIP Tap) x 3/8" FIP	30"	25	16.1
CSSD48-36	026613120447	1/2" MIP (3/8" FIP Tap) x 3/8" FIP	36"	25	17.6
CSSD48-48	026613120430	1/2" MIP (3/8" FIP Tap) x 3/8" FIP	48"	25	20.8
CSSD48-60	026613126425	1/2" MIP (3/8" FIP Tap) x 3/8" FIP	60"	12	11.6
CSSD48-72	026613126418	1/2" MIP (3/8" FIP Tap) x 3/8" FIP	72"	12	13.0



3/8" ID (1/2" OD) - FIP x FIP					CSSD
CSSD55-12	026613113432	1/2" FIP x 1/2" FIP	12"	25	12.2
CSSD55-18	026613113449	1/2" FIP x 1/2" FIP	18"	25	13.5
CSSD55-24	026613113456	1/2" FIP x 1/2" FIP	24"	25	15.0
CSSD55-30	026613121116	1/2" FIP x 1/2" FIP	30"	25	16.6
CSSD55-36	026613113463	1/2" FIP x 1/2" FIP	36"	25	18.2
CSSD55-48	026613113470	1/2" FIP x 1/2" FIP	48"	25	21.3
CSSD55-60	026613125558	1/2" FIP x 1/2" FIP	60"	12	11.4
CSSD55-72	026613144177	1/2" FIP x 1/2" FIP	72"	12	13.0
CSSD58-12	026613130804	1/2" FIP x 3/8" FIP	12"	25	11.3
CSSD58-18	026613126289	1/2" FIP x 3/8" FIP	18"	25	12.5
CSSD58-24	026613126272	1/2" FIP x 3/8" FIP	24"	25	14.0
CSSD58-30	026613144184	1/2" FIP x 3/8" FIP	30"	25	15.7

PART NO.	UPC	DESCRIPTION	LENGTH	QTY	LBS
3/8" ID (1/2" OD) - FIP x FIP (cont.)					CSSD
CSSD58-36	026613144191	1/2" FIP x 3/8" FIP	36"	25	17.2
CSSD58-48	026613144207	1/2" FIP x 3/8" FIP	48"	25	18.8
CSSD58-60	026613133386	1/2" FIP x 3/8" FIP	60"	12	10.5
CSSD58-72	026613144214	1/2" FIP x 3/8" FIP	72"	12	12.0



3/8" ID (1/2" OD) - MIP x Gas Ball Valve					CSSD
CSSD4K-12	026613113364	1/2" MIP (3/8" FIP Tap) x 1/2" FIP Gas Ball Valve	12"	25	18.9
CSSD4K-18	026613112435	1/2" MIP (3/8" FIP Tap) x 1/2" FIP Gas Ball Valve	18"	25	20.3
CSSD4K-24	026613112442	1/2" MIP (3/8" FIP Tap) x 1/2" FIP Gas Ball Valve	24"	25	22.0
CSSD4K-30	026613113371	1/2" MIP (3/8" FIP Tap) x 1/2" FIP Gas Ball Valve	30"	25	23.7
CSSD4K-36	026613112459	1/2" MIP (3/8" FIP Tap) x 1/2" FIP Gas Ball Valve	36"	25	25.1
CSSD4K-48	026613113388	1/2" MIP (3/8" FIP Tap) x 1/2" FIP Gas Ball Valve	48"	25	28.4
CSSD4K-60	026613113395	1/2" MIP (3/8" FIP Tap) x 1/2" FIP Gas Ball Valve	60"	12	15.1
CSSD4K-72	026613120928	1/2" MIP (3/8" FIP Tap) x 1/2" FIP Gas Ball Valve	72"	12	16.8



3/8" ID (1/2" OD) - FIP x Gas Ball Valve					CSSD
CSSD5K-12	026613128788	1/2" FIP x 1/2" FIP Gas Ball Valve	12"	25	18.5
CSSD5K-30	026613126401	1/2" FIP x 1/2" FIP Gas Ball Valve	30"	25	23.3
CSSD5K-36	026613121970	1/2" FIP x 1/2" FIP Gas Ball Valve	36"	25	24.7
CSSD5K-48	026613128795	1/2" FIP x 1/2" FIP Gas Ball Valve	48"	25	27.9
CSSD5K-60	026613130385	1/2" FIP x 1/2" FIP Gas Ball Valve	60"	12	14.9
CSSD5K-72	026613144221	1/2" FIP x 1/2" FIP Gas Ball Valve	72"	12	27.9



1/4" ID (3/8" OD) - MIP x MIP					CSSL
CSSL44-12	026613113548	1/2" MIP (3/8" FIP Tap) x 1/2" MIP (3/8" FIP Tap)	12"	25	11.2
CSSL44-18	026613113531	1/2" MIP (3/8" FIP Tap) x 1/2" MIP (3/8" FIP Tap)	18"	25	12.1
CSSL44-24	026613112527	1/2" MIP (3/8" FIP Tap) x 1/2" MIP (3/8" FIP Tap)	24"	25	13.3
CSSL44-30	026613113555	1/2" MIP (3/8" FIP Tap) x 1/2" MIP (3/8" FIP Tap)	30"	25	14.5
CSSL44-36	026613113562	1/2" MIP (3/8" FIP Tap) x 1/2" MIP (3/8" FIP Tap)	36"	25	15.8
CSSL44-48	026613113579	1/2" MIP (3/8" FIP Tap) x 1/2" MIP (3/8" FIP Tap)	48"	25	18.6
CSSL44-60	026613117485	1/2" MIP (3/8" FIP Tap) x 1/2" MIP (3/8" FIP Tap)	60"	12	10.1
CSSL44-72	026613119960	1/2" MIP (3/8" FIP Tap) x 1/2" MIP (3/8" FIP Tap)	72"	12	11.2
CSSL47-18	026613118208	1/2" MIP (3/8" FIP Tap) x 3/8" MIP	18"	25	11.4
CSSL47-24	026613118192	1/2" MIP (3/8" FIP Tap) x 3/8" MIP	24"	25	12.6
CSSL47-36	026613118222	1/2" MIP (3/8" FIP Tap) x 3/8" MIP	36"	25	15.1
CSSL47-48	026613144238	1/2" MIP (3/8" FIP Tap) x 3/8" MIP	48"	25	18.0
CSSL47-60	026613141145	1/2" MIP (3/8" FIP Tap) x 3/8" MIP	60"	12	9.4
CSSL77-18	026613120065	3/8" MIP x 3/8" MIP	18"	25	10.7
CSSL77-24	026613113722	3/8" MIP x 3/8" MIP	24"	25	11.9
CSSL77-30	026613125008	3/8" MIP x 3/8" MIP	30"	25	13.1
CSSL77-36	026613117751	3/8" MIP x 3/8" MIP	36"	25	14.4
CSSL77-48	026613121925	3/8" MIP x 3/8" MIP	48"	25	17.2



If your requirements are not listed, please request a special quotation from the nearest BrassCraft office. UPC code will be provided at time of shipment.

PART NO.	UPC	DESCRIPTION	LENGTH	QTY	LBS
1/4" ID (3/8" OD) - FIP x MIP					CSSL
CSSL54-12	026613113630	1/2" FIP x 1/2" MIP (3/8" FIP Tap)	12"	25	10.7
CSSL54-18	026613113647	1/2" FIP x 1/2" MIP (3/8" FIP Tap)	18"	25	11.6
CSSL54-24	026613113654	1/2" FIP x 1/2" MIP (3/8" FIP Tap)	24"	25	12.8
CSSL54-30	026613113661	1/2" FIP x 1/2" MIP (3/8" FIP Tap)	30"	25	14.0
CSSL54-36	026613113678	1/2" FIP x 1/2" MIP (3/8" FIP Tap)	36"	25	15.3
CSSL54-48	026613113685	1/2" FIP x 1/2" MIP (3/8" FIP Tap)	48"	25	18.1
CSSL54-60	026613113692	1/2" FIP x 1/2" MIP (3/8" FIP Tap)	60"	12	9.9
CSSL54-72	026613113708	1/2" FIP x 1/2" MIP (3/8" FIP Tap)	72"	12	11.0
CSSL57-12	026613113715	1/2" FIP x 3/8" MIP	12"	25	10.0
CSSL57-18	026613120539	1/2" FIP x 3/8" MIP	18"	25	10.9
CSSL57-24	026613117928	1/2" FIP x 3/8" MIP	24"	25	12.1
CSSL57-30	026613118673	1/2" FIP x 3/8" MIP	30"	25	13.3
CSSL57-36	026613117935	1/2" FIP x 3/8" MIP	36"	25	14.4
CSSL57-48	026613119847	1/2" FIP x 3/8" MIP	48"	25	17.4
CSSL57-60	026613118727	1/2" FIP x 3/8" MIP	60"	12	9.1
CSSL57-72	026613144245	1/2" FIP x 3/8" MIP	72"	12	11.0
CSSL48-12	026613119090	3/8" FIP x 1/2" MIP (3/8" FIP Tap)	12"	25	9.9
CSSL48-18	026613119106	3/8" FIP x 1/2" MIP (3/8" FIP Tap)	18"	25	10.8
CSSL48-24	026613118178	3/8" FIP x 1/2" MIP (3/8" FIP Tap)	24"	25	12.0
CSSL48-30	026613121598	3/8" FIP x 1/2" MIP (3/8" FIP Tap)	30"	25	13.1
CSSL48-36	026613120416	3/8" FIP x 1/2" MIP (3/8" FIP Tap)	36"	25	14.4
CSSL48-48	026613120423	3/8" FIP x 1/2" MIP (3/8" FIP Tap)	48"	25	17.2
CSSL48-72	026613121628	3/8" FIP x 1/2" MIP (3/8" FIP Tap)	72"	12	10.6
CSSL87-12	026613113753	3/8" FIP x 3/8" MIP	12"	25	9.1
CSSL87-18	026613113760	3/8" FIP x 3/8" MIP	18"	25	10.0
CSSL87-24	026613113777	3/8" FIP x 3/8" MIP	24"	25	11.2
CSSL87-30	026613119885	3/8" FIP x 3/8" MIP	30"	25	12.4
CSSL87-36	026613113784	3/8" FIP x 3/8" MIP	36"	25	13.7
CSSL87-48	026613120232	3/8" FIP x 3/8" MIP	48"	25	16.5
CSSL87-60	026613120058	3/8" FIP x 3/8" MIP	60"	12	9.1
CSSL87-72	026613144252	3/8" FIP x 3/8" MIP	72"	12	10.0
1/4" ID (3/8" OD) - FIP x FIP					CSSL
CSSL55-12	026613118239	1/2" FIP x 1/2" FIP	12"	25	10.3
CSSL55-18	026613118246	1/2" FIP x 1/2" FIP	18"	25	11.2
CSSL55-24	026613117843	1/2" FIP x 1/2" FIP	24"	25	12.4
CSSL55-30	026613118253	1/2" FIP x 1/2" FIP	30"	25	13.5
CSSL55-36	026613118260	1/2" FIP x 1/2" FIP	36"	25	14.8
CSSL55-48	026613118277	1/2" FIP x 1/2" FIP	48"	25	17.6
CSSL55-60	026613144269	1/2" FIP x 1/2" FIP	60"	12	10.0
CSSL55-72	026613144276	1/2" FIP x 1/2" FIP	72"	12	11.0
CSSL88-12	026613121611	3/8" FIP x 3/8" FIP	12"	25	8.5
CSSL88-18	026613113791	3/8" FIP x 3/8" FIP	18"	25	9.4
CSSL88-24	026613113807	3/8" FIP x 3/8" FIP	24"	25	10.6



PART NO.	UPC	DESCRIPTION	LENGTH	QTY	LBS
1/4" ID (3/8" OD) - FIP x FIP (cont.)					CSSL
CSSL88-30	026613144283	3/8" FIP x 3/8" FIP	30"	25	13.0
CSSL88-36	026613113814	3/8" FIP x 3/8" FIP	36"	25	13.1
CSSL88-48	026613113821	3/8" FIP x 3/8" FIP	48"	25	15.9
CSSL88-60	026613121369	3/8" FIP x 3/8" FIP	60"	12	8.8



1/4" ID (3/8" OD) - MIP x Gas Ball Valve					CSSL
CSSL4M-12	026613113586	1/2" MIP (3/8" FIP Tap) x 1/2" FIP Gas Ball Valve	12"	25	16.5
CSSL4M-18	026613113593	1/2" MIP (3/8" FIP Tap) x 1/2" FIP Gas Ball Valve	18"	25	17.6
CSSL4M-24	026613113609	1/2" MIP (3/8" FIP Tap) x 1/2" FIP Gas Ball Valve	24"	25	18.9
CSSL4M-30	026613118857	1/2" MIP (3/8" FIP Tap) x 1/2" FIP Gas Ball Valve	30"	25	19.9
CSSL4M-36	026613113616	1/2" MIP (3/8" FIP Tap) x 1/2" FIP Gas Ball Valve	36"	25	21.3
CSSL4M-48	026613113623	1/2" MIP (3/8" FIP Tap) x 1/2" FIP Gas Ball Valve	48"	25	24.3
CSSL4M-60	026613119526	1/2" MIP (3/8" FIP Tap) x 1/2" FIP Gas Ball Valve	60"	12	12.6
CSSL4M-72	026613121413	1/2" MIP (3/8" FIP Tap) x 1/2" FIP Gas Ball Valve	72"	12	13.8
CSSL7M-12	026613113739	3/8" MIP x 1/2" FIP Gas Ball Valve	12"	25	15.8
CSSL7M-18	026613113746	3/8" MIP x 1/2" FIP Gas Ball Valve	18"	25	16.8
CSSL7M-24	026613121420	3/8" MIP x 1/2" FIP Gas Ball Valve	24"	25	18.2
CSSL7M-36	026613121444	3/8" MIP x 1/2" FIP Gas Ball Valve	36"	25	20.3
CSSL7M-48	026613133607	3/8" MIP x 1/2" FIP Gas Ball Valve	48"	25	23.6
CSSL7M-60	026613144290	3/8" MIP x 1/2" FIP Gas Ball Valve	60"	12	12.0



1/4" ID (3/8" OD) - FIP x Gas Ball Valve					CSSL
CSSL8M-24	026613119748	3/8" FIP x 1/2" FIP Gas Ball Valve	24"	25	17.5
CSSL8M-30	026613144306	3/8" FIP x 1/2" FIP Gas Ball Valve	30"	25	19.0
CSSL8M-36	026613119786	3/8" FIP x 1/2" FIP Gas Ball Valve	36"	25	19.7
CSSL8M-48	026613113951	3/8" FIP x 1/2" FIP Gas Ball Valve	48"	25	22.9
CSSL8M-72	026613144313	3/8" FIP x 1/2" FIP Gas Ball Valve	72"	12	13.0



1/4" ID (3/8" OD) CSSL MIP x MIP w/ 9/16-24 Fine Thread Adapter Included					CSST
CSST44-24	026613126357	1/2" MIP (3/8" FIP Tap) x 1/2" MIP (3/8" FIP Tap)	24"	25	13.3
CSST44-36	026613120799	1/2" MIP (3/8" FIP Tap) x 1/2" MIP (3/8" FIP Tap)	36"	25	15.8
CSST44-72	026613125565	1/2" MIP (3/8" FIP Tap) x 1/2" MIP (3/8" FIP Tap)	72"	12	10.7



1/4" ID (3/8" OD) CSSL - FIP x MIP w/ 9/16-24 Fine Thread Adapter Included					CSST
CSST54-12	026613118352	1/2" FIP x 1/2" MIP (3/8" FIP Tap)	12"	25	11.0
CSST54-18	026613113975	1/2" FIP x 1/2" MIP (3/8" FIP Tap)	18"	25	11.9
CSST54-24	026613113982	1/2" FIP x 1/2" MIP (3/8" FIP Tap)	24"	25	13.1
CSST54-36	026613113999	1/2" FIP x 1/2" MIP (3/8" FIP Tap)	36"	25	15.6
CSST54-48	026613114019	1/2" FIP x 1/2" MIP (3/8" FIP Tap)	48"	25	18.4



If your requirements are not listed, please request a special quotation from the nearest BrassCraft office. UPC code will be provided at time of shipment.









PART NO.	UPC	DESCRIPTION	LENGTH	QTY	LBS
1/4" ID (3/8" OD) 1/2 FIP x 3/8 FIP with 9/16 24 Fine Thread Female Flare Adapter					
CSST					
CSST58-18 P	026613180984	1/2" FIP x 3/8" FIP FF FT	18"	5	3.4
CSST58-24 P	026613180991	1/2" FIP x 3/8" FIP FF FT	24"	5	3.6
CSST58-36 P	026613181004	1/2" FIP x 3/8" FIP FF FT	36"	5	4.0
CSST58-60 P	026613181011	1/2" FIP x 3/8" FIP FF FT	60"	5	5.0
CSST58-72 P	026613181028	1/2" FIP x 3/8" FIP FF FT	72"	5	5.4

1/4" ID (3/8" OD) CSSL - FIP x MIP w/ 9/16-24 Fine Thread Adapter Included

PART NO.	UPC	DESCRIPTION	LENGTH	QTY	LBS
CSST					
CSST87-18	026613118123	3/8" FIP x 3/8" MIP	18"	25	9.9
CSST87-36	026613119731	3/8" FIP x 3/8" MIP	36"	25	13.6
CSST87-60	026613144320	3/8" FIP x 3/8" MIP	60"	12	6.0

1/4" ID (3/8" OD) CSSL - FIP x FIP w/ 9/16-24 Fine Thread Adapter Included

PART NO.	UPC	DESCRIPTION	LENGTH	QTY	LBS
CSST					
CSST88-36	026613144337	3/8" FIP x 3/8" FIP	36"	25	13.0
CSST88-60	026613144344	3/8" FIP x 3/8" FIP	60"	12	6.0
CSST88-72	026613144351	3/8" FIP x 3/8" FIP	72"	12	9.0

PART NO.	UPC	DESCRIPTION	LENGTH	QTY	LBS	
3/8" ID (1/2" OD) - MIP x MIP						BCSSD
BCSSD44-18	026613131382	1/2" MIP (3/8" FIP Tap) x 1/2" MIP (3/8" FIP Tap)	18"	25	14.4	
BCSSD44-24	026613131399	1/2" MIP (3/8" FIP Tap) x 1/2" MIP (3/8" FIP Tap)	24"	25	16.0	
BCSSD44-30	026613131405	1/2" MIP (3/8" FIP Tap) x 1/2" MIP (3/8" FIP Tap)	30"	25	17.6	
BCSSD47-12	026613131412	1/2" MIP (3/8" FIP Tap) x 3/8" MIP	12"	25	12.3	
BCSSD47-18	026613131429	1/2" MIP (3/8" FIP Tap) x 3/8" MIP	18"	25	13.5	
BCSSD47-24	026613131481	1/2" MIP (3/8" FIP Tap) x 3/8" MIP	24"	25	15.1	
BCSSD47-30	026613131436	1/2" MIP (3/8" FIP Tap) x 3/8" MIP	30"	25	16.8	
3/8" ID (1/2" OD) - FIP x MIP						BCSSD
BCSSD54-12	026613134413	1/2" FIP x 1/2" MIP (3/8" FIP Tap)	12"	25	12.7	
BCSSD54-18	026613132327	1/2" FIP x 1/2" MIP (3/8" FIP Tap)	18"	25	14.0	
BCSSD54-24	026613132310	1/2" FIP x 1/2" MIP (3/8" FIP Tap)	24"	25	15.5	
BCSSD54-36	026613132723	1/2" FIP x 1/2" MIP (3/8" FIP Tap)	36"	25	18.7	
3/8" ID (1/2" OD) - FIP x FIP						BCSSD
BCSSD55-18	026613142999	1/2" FIP x 1/2" FIP	18"	25	14.0	
BCSSD55-24	026613134680	1/2" FIP x 1/2" FIP	24"	25	15.1	
3/8" ID (1/2" OD) - MIP x Gas Ball Valve						BCSSD
BCSSD4K-12	026613142968	1/2" MIP (3/8" FIP Tap) x 1/2" FIP Gas Ball Valve	12"	25	19.0	
BCSSD4K-18	026613142975	1/2" MIP (3/8" FIP Tap) x 1/2" FIP Gas Ball Valve	18"	25	20.0	
BCSSD4K-30	026613142982	1/2" MIP (3/8" FIP Tap) x 1/2" FIP Gas Ball Valve	30"	25	24.0	
3/8" ID (1/2" OD) - FIP x Gas Ball Valve						BCSSD
BCSSD5K-12	026613144375	1/2" FIP x 1/2" FIP Gas Ball Valve	12"	25	18.0	
BCSSD5K-24	026613144382	1/2" FIP x 1/2" FIP Gas Ball Valve	24"	25	21.0	
BCSSD5K-30	026613144399	1/2" FIP x 1/2" FIP Gas Ball Valve	30"	25	23.0	
1/4" ID (3/8" OD) - MIP x MIP						BCSSL
BCSSL44-12	026613131313	1/2" MIP (3/8" FIP Tap) x 1/2" MIP (3/8" FIP Tap)	12"	25	11.2	
BCSSL44-18	026613131320	1/2" MIP (3/8" FIP Tap) x 1/2" MIP (3/8" FIP Tap)	18"	25	12.8	
BCSSL44-24	026613131337	1/2" MIP (3/8" FIP Tap) x 1/2" MIP (3/8" FIP Tap)	24"	25	13.3	
BCSSL47-12	026613131344	1/2" MIP (3/8" FIP Tap) x 3/8" MIP	12"	25	10.6	
BCSSL47-18	026613131474	1/2" MIP (3/8" FIP Tap) x 3/8" MIP	18"	25	11.5	
BCSSL47-24	026613131351	1/2" MIP (3/8" FIP Tap) x 3/8" MIP	24"	25	13.0	
1/4" ID (3/8" OD) - FIP x MIP						BCSSL
BCSSL54-18	026613144405	1/2" FIP x 1/2" MIP (3/8" FIP Tap)	18"	25	11.7	
BCSSL54-24	026613133812	1/2" FIP x 1/2" MIP (3/8" FIP Tap)	24"	25	12.9	
1/4" ID (3/8" OD) - MIP x Gas Ball Valve						BCSSL
BCSSL7M-12	026613142074	3/8" MIP x 1/2" FIP Gas Ball Valve	12"	25	15.8	
BCSSL7M-18	026613144450	3/8" MIP x 1/2" FIP Gas Ball Valve	18"	25	18.0	
BCSSL7M-30	026613144467	3/8" MIP x 1/2" FIP Gas Ball Valve	30"	25	20.0	

If your requirements are not listed, please request a special quotation from the nearest BrassCraft office. UPC code will be provided at time of shipment.

PART NO.	UPC	DESCRIPTION	LENGTH	QTY	LBS
1/4" ID (3/8" OD) - FIP x MIP					BCSSL
 BCSSL87-12	026613132303	3/8" FIP x 3/8" MIP	12"	25	9.2
BCSSL87-18	026613132174	3/8" FIP x 3/8" MIP	18"	25	10.1
BCSSL87-24	026613132297	3/8" FIP x 3/8" MIP	24"	25	11.6
BCSSL87-30	026613132280	3/8" FIP x 3/8" MIP	30"	25	12.5

1/4" ID (3/8" OD) - MIP x Gas Ball Valve					BCSSL
 BCSSL4M-12	026613144429	1/2" MIP (3/8" FIP Tap) x 1/2" FIP Gas Ball Valve	12"	25	16.0
BCSSL4M-18	026613133973	1/2" MIP (3/8" FIP Tap) x 1/2" FIP Gas Ball Valve	18"	25	17.6
BCSSL4M-24	026613144436	1/2" MIP (3/8" FIP Tap) x 1/2" FIP Gas Ball Valve	24"	25	19.0
BCSSL4M-30	026613144443	1/2" MIP (3/8" FIP Tap) x 1/2" FIP Gas Ball Valve	30"	25	21.0

1/4" ID (3/8" OD) - FIP x Gas Ball Valve					BCSSL
 BCSSL8M-18	026613144474	3/8" FIP x 1/2" FIP Gas Ball Valve	18"	25	16.0
BCSSL8M-24	026613144481	3/8" FIP x 1/2" FIP Gas Ball Valve	24"	25	17.0
BCSSL8M-30	026613144498	3/8" FIP x 1/2" FIP Gas Ball Valve	30"	25	18.0



Gas Installation Kits

are designed to fit most new and older appliances. Kits contain everything needed to make a quick and easy gas connection.



- ProCoat® Coated Stainless Steel Gas Connector
- Safety+PLUS® Excess Flow Valve*
- Multiple Steel Gas Fittings to Fit Most Appliances
- Pipe Thread Sealant
- Leak Detection Solution

*Included with PSC1107, PSC1106 kits only.

PART NO.	UPC	DESCRIPTION	LENGTH	QTY	LBS
----------	-----	-------------	--------	-----	-----

ProCoat® Tankless Water Heater Installation Kit

PSB1096 L	039166108497	(1) CSSB21-24 7/8" OD x 24" yellow coated gas connector (1) AU2-14-12 1/2" FIP steel fitting (1) AU2-14-16 1" MIP steel fitting (1) AU1-14-12 3/4" FIP steel fitting (1) AU1-14-16 1" FIP steel fitting (1) 3mil tube of pipe thread sealant (2) 3mil tube of I	24"	5	10.2
-----------	--------------	---	-----	---	------



Black ProCoat® Gas Installation Kit for Gas Log & Space Heater

PSC1079	026613114439	(1) BCSSD54-24 1/2" OD x 24" black coated gas connector (1) AU2-8S 1/2" MIP (3/8" FIP) steel fitting (1) AU1-8S 1/2" FIP steel fitting (1) AU2-8-6S 3/8" MIP steel fitting (1) 3mil tube of pipe thread sealant (1) 3mil tube of leak detection solution	24"	5	5.9
---------	--------------	---	-----	---	-----

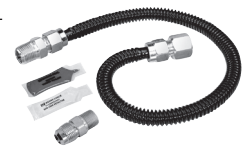

Electric Water Heater Installation Kit

PSC1085X L	039166111619	(2) BWB20-15 3/4" MIP x 3/4" FIP x 15" flexible polymer braided water heater connector (2) 68-14-12X B compression x male adaptor (1) 3mil tube of pipe thread sealant	15"	5	11.9
------------	--------------	--	-----	---	------



PART NO.	UPC	DESCRIPTION	LENGTH	QTY	LBS
----------	-----	-------------	--------	-----	-----

ProCoat® Gas Water Heater Installation Kit



PSC1098 L	039166108558	(1) CSSD44-18 1/2" OD x 18" yellow coated gas connector (2) AU2-8S 1/2" MIP (3/8" FIP) steel fitting (1) AU1-8S 1/2" FIP steel fitting (2) BWB020-15 x 15" braided water heater connector (2) 68-14-12X B compression x male adaptor (1) 3mil tube of pipe thre	18"	5	15.3
-----------	--------------	--	-----	---	------

Safety+PLUS® Gas Installation Kit for Range & Dryer

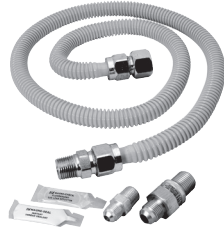

PSC1106	039166123889	(1) CSSD44R-48 1/2" OD x 48" yellow coated gas connector (1) RU2-8L Safety+PLUS EFV (1/2" MIP) (1) AU2-8S 1/2" MIP (3/8" FIP) steel fitting (1) AU1-8S 1/2" FIP steel fitting	48"	10	18.0
---------	--------------	--	-----	----	------

Safety+PLUS® Gas Installation Kit for Pro-Grade Range & Furnace



PSC1107	039166123896	(1) CSSC54R-48 5/8" OD (15/16-16 Thread) x 48" yellow coated gas connector (1) MRU2-10-12 Safety+PLUS EFV 3/4" MIP (1/2" FIP) (1) MAU2-10-12S 3/4" MIP (1/2" FIP) steel fitting (1) MAU2-10-8S 1/2" MIP steel fitting (1) 3mil tube of pipe thread sealant	48"	10	21.0
---------	--------------	--	-----	----	------

Safety+PLUS® Gas Water Heater Installation Kit

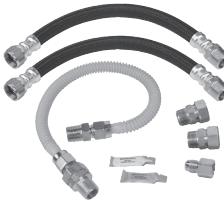

PSC1108X L	039166123902	(2) BWB20-15 3/4" MIP x 3/4" FIP x 15" flexible polymer braided water heater connector (2) 68-14-12X B compression x male adaptor (1) CSSD44R-18 1/2" OD x 18" yellow coated gas connector (1) RU2-8 Safety+PLUS EFV (1/2" MIP) (1) AU2-8-6S 3/8" MIP steel fitt	18"	5	15.6
------------	--------------	--	-----	---	------

Tankless Water Heater Installation Kits

As the world leader in gas and water products, BrassCraft®'s tankless water heater installation kits are no exception. Compliant with 2014 no-lead requirements, our tankless water heater installation kits simplify the installation process with fewer connections and a clean, professional finish. Featuring independent, 1/4 turn water control, BrassCraft® service valves make it simple to service and test the appliance.

Large Capacity Gas Connector with exclusive ProCoat® corrosion resistant coating

Built-In Port for PR Valve reduces the number of connections required

Integrated Drain Valve with independent, 1/4 turn operation

Right-Sized Handles color coded and great for tight installations

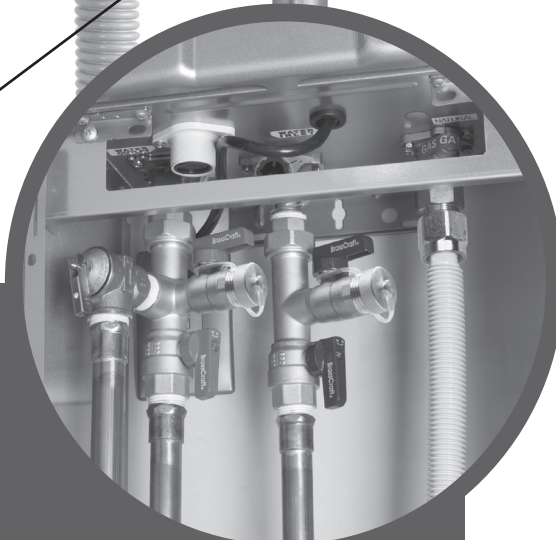
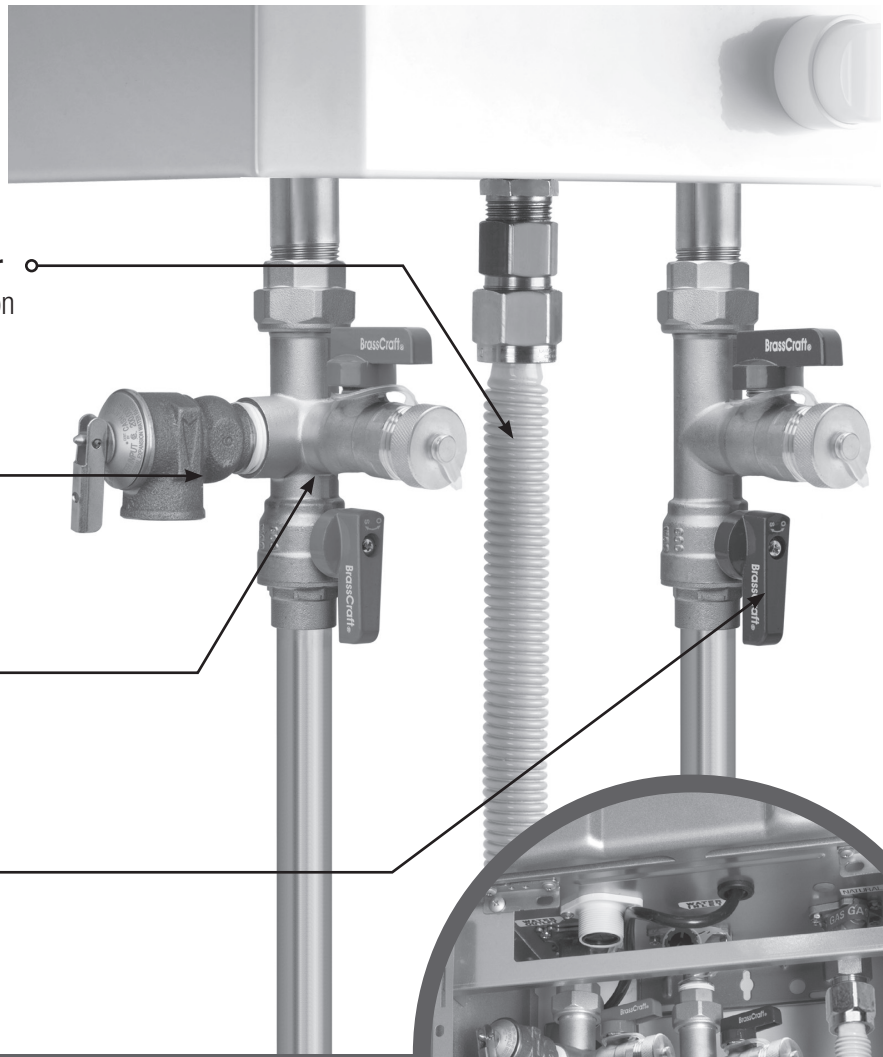

BrassCraft® Tankless Water Heater Kits offer a wide range of features including:

- One-piece, forged brass body
- Drain valve with brass safety cap
- 3/4" ID coated stainless steel gas connector
- Available in sweat & IPS configurations
- Optional full-port gas ball valve



Service Valves



Gas Connector & Gas Ball Valve

Ideal for Recessed and Cover Box Installations

TANKLESS WATER HEATER INSTALLATION KITS



PART NO.	UPC	DESCRIPTION	LENGTH	QTY	LBS
Service Valve Kits					IPS
TWV30X	026613141350	IPS x IPS Service Valve Kit	N/A	6	7.8



Service Valve Kits with PRV					IPS
TWV30RX	026613141343	IPS x IPS Service Valve Kit with Pressure Relief Valve (200 kBtu/hr)	N/A	6	10.8



Service Valve Kits					SWEAT
TWV3SX	026613141411	Sweat x IPS Service Valve Kit	N/A	6	8.5



Service Valve Kits with PRV					SWEAT
TWV3SRX	026613141404	Sweat x IPS Service Valve Kit with Pressure Relief Valve (200 kBtu/hr)	N/A	6	11.5



Service Valve Kits with Gas Connector					IPS
TK30RB21-18X	026613141367	IPS x IPS Service Valve Kit with 3/4" ID (3/4" FIP x 3/4" MIP) x 18" Yellow Coated Gas Connector & PR Valve	18"	3	10.8
TK30RB21-24X	026613141374	IPS x IPS Service Valve Kit with 3/4" ID (3/4" FIP x 3/4" MIP) x 24" Yellow Coated Gas Connector & PR Valve	24"	3	11.1

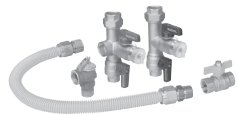

Service Valve Kits with Gas Connector & Gas Ball Valve					IPS
TK30RB21-18G3X	026613141381	IPS x IPS Service Valve Kit with 3/4" ID (3/4" FIP x 3/4" MIP) x 18" Yellow Coated Gas Connector, 3/4" Full-Port Gas Ball Valve & PR Valve	18"	3	12.8
TK30RB21-24G3X	026613141398	IPS x IPS Service Valve Kit with 3/4" ID (3/4" FIP x 3/4" MIP) x 24" Yellow Coated Gas Connector, 3/4" Full-Port Gas Ball Valve & PR Valve	24"	3	13.1

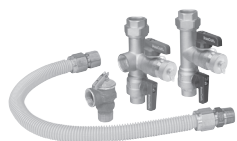

Service Valve Kits with Gas Connector					SWEAT
TK3SRB21-18X	026613141923	Sweat x IPS Service Valve Kit with 3/4" ID (3/4" FIP x 3/4" MIP) x 18" Yellow Coated Gas Connector & PR Valve	18"	3	11.2
TK3SRB21-24X	026613141930	Sweat x IPS Service Valve Kit with 3/4" ID (3/4" FIP x 3/4" MIP) x 24" Yellow Coated Gas Connector & PR Valve	24"	3	11.5

Part Numbering System

Example:

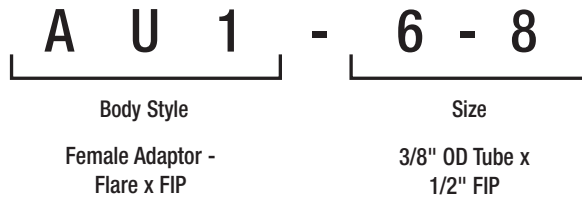

AU1

 Body Style

Body Style

Safety+PLUS® Appliance Excess Flow Valves:

- MRU1* / RU1** Female Adaptor - Flare x FIP
- MRU2* / RU2** Male Adaptor - Flare x MIP (Tapped FIP Option)
- MRU4* / RU4** Male Adaptor - Flare x MIP (Tapped Female Flare)
- MRU5* / EU5** Female Union - Flare x Female Flare

Adaptor Fittings:

- MAU1* / AU1** Female Adaptor - Flare x FIP
- MAU2* / AU2** Male Adaptor - Flare x MIP (Tapped FIP)
- MAE1*** Female Elbow
- AU6** Female Flare x MIP Adaptor
- AU7** Female Flare x FIP Adaptor

Fine-Thread Adaptor Fittings:

- F10/12** Male Adaptor
- F15/17** Female Elbow
- FC** Flare Cap
- FO** Flare Nut

- FRC11/13** Female Adaptor
- FRC16/18** Male Elbow
- FT3** Flare Tee
- FU3** Flare Union
- FA6-8** Female Flare Fine Thread Adaptor

Gas Ball Valves:

- TBV** FIP x Flare or FIP x FIP
- TBVA** FIP x Flare (Angle)
- TBVF** Flare x Flare
- TBV#F** FIP x FIP (Full Port)

**Fittings with 5/8" OD (15/16 -16 Thread)*

CAUTION: Use only 5/8" OD Flare (15/16 -16 Thread) Gas Fittings and Valves with 5/8" OD Gas Appliance Connectors (BrassCraft CSSC Series)

6 - 8

 Size

Size

Tube & Pipe Sizing:

2	1/8"	5	5/16"	8	1/2"	14	7/8"
3	3/16"	6	3/8"	10	5/8"	16	1"
4	1/4"	7	7/16"	12	3/4"		

Gas Ball Valves

Superior Performance and Reliability



Forged Brass Body

Eliminates pinhole leaks commonly associated with cast products.

Specially Designed Seat Rings

PTFE seats assure longer life.

Quarter-Turn Design

For easy on/off operation.

Blow-Out Proof Stem

Assembled from the inside with double o-rings to help ensure safe, reliable performance.

100% Leak Tested

Each valve is leak tested to help ensure reliability.

Handle Design

Integrates "T" and lever handles into one, saving inventory SKUs and dollars.

Made in Italy*



PART NO.	UPC	DESCRIPTION	QTY	LBS
Flare x FIP - Angle				
TBVA8-6	026613166070	1/2" OD Flare x 3/8" FIP	10	3.6
FIP x FIP - Full Port				
TBV12F	026613139609	3/4" FIP x 3/4" FIP	6	4.1
FIP x FIP				
TBV16	026613099439	1" FIP x 1" FIP	6	6.0
TBV12	026613099422	3/4" FIP x 3/4" FIP	10	5.7
TBV8	026613099415	1/2" FIP x 1/2" FIP	10	3.6

*Except where noted

PART NO.	UPC	DESCRIPTION	QTY	LBS
Flare x FIP				
TBV10-12	026613099385	5/8" OD Flare (15/16-16 Thread) x 3/4" FIP	10	5.9
TBV10-8	026613099378	5/8" OD Flare (15/16-16 Thread) x 1/2" FIP	10	5.4
TBV8-8	026613099361	1/2" OD Flare x 1/2" FIP	10	3.9
TBV6-8	026613099347	3/8" OD Flare x 1/2" FIP	10	.2
TBV6F-8	026613099354	3/8" OD Flare (9/16-24 Fine Thread) x 1/2" FIP	10	3.5



Flare x FIP - Angle				
TBVA10-12	026613099392	5/8" OD Flare (15/16-16 Thread) x 3/4" FIP	10	.3
TBVA8-8	026613100241	1/2" OD Flare x 1/2" FIP	10	5.3
TBVA6-8	026613100258	3/8" OD Flare x 1/2" FIP	10	5.3



Flare x Flare				
TBVF6	026613099316	3/8" OD Flare x 3/8" OD Flare	10	3.4
TBVF8	026613099323	1/2" OD Flare x 1/2" OD Flare	10	3.7
TBVF10	026613099330	5/8" OD Flare x 5/8" OD Flare	10	6.4

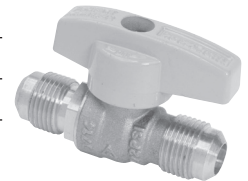

FIP x FIP - ECONOMY (China)				
LBV12	026613122069	3/4" FIP x 3/4" FIP	10	4.6
LBV8	026613122052	1/2" FIP x 1/2" FIP	10	3.2





PART NO.	UPC	DESCRIPTION	USE WITH CONNECTOR	QTY	LBS
Flare x FIP			CSSB		
AU1-14-12	026613132846	7/8" OD Flare x 3/4" FIP, Steel		10	1.8



PART NO.	UPC	DESCRIPTION	USE WITH CONNECTOR	QTY	LBS
Flare x MIP			CSSB		
AU2-14-12	026613132860	7/8" OD Flare x 3/4" MIP (1/2" FIP), Brass		10	2.6
AU2-14-16	026613132877	7/8" OD Flare x 1" MIP (3/4" FIP), Brass		10	4.2



PART NO.	UPC	DESCRIPTION	USE WITH CONNECTOR	QTY	LBS
Flare x FIP			CSSC		
MAU1-10-12S	026613082660	5/8" OD Flare (15/16-16 Thread) x 3/4" FIP, Steel		25	4.8



MAU1-10-8S	026613088570	5/8" OD Flare (15/16-16 Thread) x 1/2" FIP, Steel		25	4.2
------------	--------------	---	--	----	-----



MAE1-10-12	026613084213	5/8" OD (15/16-16 Thread) Flare x 3/4" FIP, Brass		25	8.1
------------	--------------	---	--	----	-----



PART NO.	UPC	DESCRIPTION	USE WITH CONNECTOR	QTY	LBS
Flare x MIP			CSSC		
MAU2-10-12S	026613082677	5/8" OD Flare (15/16-16 Thread) x 3/4" MIP (1/2" FIP), Steel		25	6.2



MAU2-10-8S	026613082684	5/8" OD Flare (15/16-16 Thread) x 1/2" MIP (3/8" FIP), Steel		25	4.8
------------	--------------	--	--	----	-----



PART NO.	UPC	DESCRIPTION	USE WITH CONNECTOR	QTY	LBS
Female Flare x FIP			CSSC		
AU7-10-8 P	026613159355	5/8" Female Flare x 1/2" FIP		5	1.2



PART NO.	UPC	DESCRIPTION	USE WITH CONNECTOR	QTY	LBS
Flare Caps			CSSC		
M40-10	026613052069	5/8" OD (15/16-16 Thread) Flare, Brass		10	1.0

PART NO.	UPC	DESCRIPTION	QTY	LBS
Gas Connector Nuts			USE WITH CONNECTOR	CSSC
ASN-10	026613082387	5/8" OD (15/16-16 Thread) Flare, Brass	25	2.7



Flare x FIP			USE WITH CONNECTOR	CSSD
AU1-8-12S	026613088518	1/2" OD Flare x 3/4" FIP, Brass	25	3.3
AU1-8S	026613088532	1/2" OD Flare x 1/2" FIP, Steel	25	3.1



Flare x MIP			USE WITH CONNECTOR	CSSD
AU2-8-12S	026613088563	1/2" OD Flare x 3/4" MIP (1/2" FIP), Steel	25	5.1
AU2-8S	026613082646	1/2" OD Flare x 1/2" MIP (3/8" FIP), Steel	25	3.5
AU2-8-6S	026613053707	1/2" OD Flare x 3/8" MIP, Steel	10	1.1



Female Flare x MIP			USE WITH CONNECTOR	CSSD
AU6-8-6 P	026613159348	1/2" Female Flare x 3/8" MIP	5	.7



Flare Caps			USE WITH CONNECTOR	CSSD
40-8	026613004938	1/2" OD Tube, Brass	10	.4



Flare Nuts - Short			USE WITH CONNECTOR	CSSD
41S-8	026613004990	1/2" OD Tube, Brass	10	.7



Flare x FIP			USE WITH CONNECTOR	CSSL
AU1-6-8S	026613106717	3/8" OD Flare x 1/2" FIP, Steel	25	2.8



Flare x MIP			USE WITH CONNECTOR	CSSL
AU2-6-8S	026613106724	3/8" OD Flare x 1/2" MIP (3/8" FIP), Steel	25	3.2
AU2-6S	026613088549	3/8" OD Flare x 3/8" MIP, Steel	25	2.5



Flare Caps			USE WITH CONNECTOR	CSSL
40-6	026613004921	3/8" OD Tube, Brass	10	.4





PART NO.	UPC	DESCRIPTION	QTY	LBS
Flare Nuts - Short			USE WITH CONNECTOR	CSSL
41S-6	026613004976	3/8" OD Tube, Brass	10	.5

PART NO.	UPC	DESCRIPTION	QTY	LBS
Fine Thread Flare Male Elbows			USE WITH CONNECTOR	CSST
FRC16-6	026613064031	3/8" OD Tube (9/16-24 Thread) x 3/8" MIP, Brass	10	1.0



Fine Thread Flare Tees			USE WITH CONNECTOR	CSST
FT3-6	026613064055	3/8" OD Tube (9/16-24 Thread), All 3 Ends, Brass	10	1.4



Fine Thread Flare Unions			USE WITH CONNECTOR	CSST
FU3-6	026613005119	3/8" OD Tube (9/16-24 Thread), Both Ends, Brass	10	.5



Fine Thread Flare Caps			USE WITH CONNECTOR	CSST
FC-6	026613059037	3/8" OD Tube (9/16-24 Thread), Brass	10	.3



Fine Thread Flare Nuts			USE WITH CONNECTOR	CSST
F0-6	026613004785	3/8" OD Tube (9/16-24 Thread), Brass	10	.2



Part Numbering System

Example:



B	W	B	0	8	-	2	4
Type			Size and Style			Length	
Speedi Plumb® PLUS Connector			3/4" FIP Inlet x 7/8" OD Compression Outlet			24" Nominal Connector Length	

BWB

Type

Connector Type

BWB	Speedi Plumb® PLUS Engineered Polymer Braid; .57" ID w/Fittings
SWB	ProCoat® Corrugated Stainless Steel; 3/4" ID w/Fittings
WB	Copper-Flex™ Corrugated Copper; 7/8" OD w/Fittings
WC	Copper-Flex™ Corrugated Copper; 7/8" OD w/3/4" Nom Copper Sweat

08

Size and Style

End Fitting Size and Style

For BWB:

0	3/4" FIP
1	1" FIP
2	3/4" MIP
5	5/8" OD Compression
8	7/8" OD Compression
PX	PX Suffix = 3/4" PEX Barbed
PS	PS Suffix = 3/4" Push Connect

For SWB, WB, WC:

0	3/4" FIP
1	1" FIP
2	3/4" MIP/FIP
3	3/4" Nom Male Sweat (7/8" OD)
4	3/4" Nom Female Sweat (7/8" ID)
5	1/2" Nom Male Sweat (5/8" OD)
6	1/2" Nom Female Sweat (5/8" ID)
7	3/4" PEX Barbed

24

Length

Nominal Connector Length in Inches

Most connectors available in lengths from 12" to 24". Check listing for specific lengths available.

Speedi Plumb® PLUS Polymer Braided Water Heater Connectors

Superior Flexibility, Superior Corrosion Resistance

No Kinking, No Crimping

The patented polymer braided jacket is specially engineered to allow the connector to bend freely without kinking or crimping. Easy to install, the connector won't work harden with repeated bending.

Advanced Corrosion Resistance

The polymer braid is specially engineered to resist corrosion from most harsh household cleaning and repair products.

No Dielectric Union Needed*

The engineered polymer braid and rubber core are non-conductive materials and therefore eliminate the need for a dielectric union.



Less Torque to Seal

Rubber washer is easier to install on rough nipple surfaces.

Longer Connector Nuts

A greater number of thread-to-thread contact provides a better seal to lined nipples.



Push Connect
Compatible with Copper, PEX and CPVC

Installation Ready

Pre-inserted tube stiffener self aligns with the tubing to create a durable, watertight seal.

No Soldering or Glue Needed

Push Connect technology allows connecting with confidence for a fast, reliable, durable connection.



PART NO.	UPC	DESCRIPTION	LENGTH	QTY	LBS
.57" ID Tube - FIP X FIP					
BWB0-12	026613965321	3/4" FIP x 3/4" FIP	12"	10	4.8
BWB0-15	026613965406	3/4" FIP x 3/4" FIP	15"	10	5.3
BWB0-18	026613965413	3/4" FIP x 3/4" FIP	18"	10	5.8
BWB0-24	026613965420	3/4" FIP x 3/4" FIP	24"	10	6.9
.57" ID Tube - FIP X Compression					
BWB05-18	026613120836	3/4" FIP x 5/8" OD Comp	18"	10	6.0
BWB08-12	026613965369	3/4" FIP x 7/8" OD Comp	12"	10	14.5
BWB08-18	026613965383	3/4" FIP x 7/8" OD Comp	18"	10	15.5
BWB08-24	026613965390	3/4" FIP x 7/8" OD Comp	24"	10	16.6
.57" ID Tube - MIP X FIP					
BWB20-12	026613965437	3/4" MIP x 3/4" FIP	12"	10	5.2
BWB20-15	026613965444	3/4" MIP x 3/4" FIP	15"	10	5.7
BWB20-18	026613965451	3/4" MIP x 3/4" FIP	18"	10	6.3
BWB20-24	026613965468	3/4" MIP x 3/4" FIP	24"	10	7.3
BWB20-60	026613139913	3/4" MIP x 3/4" FIP	60"	10	13.1

BrassCraft Manufacturing Co. is in compliance with the National Reduction of Lead in Drinking Water Act. This legislation changed the legal definition of "lead free" from 8% lead to a weighted average lead content of 0.25% with respect to wetted surfaces.

*Check your local inspection office for applicable code requirements.

PART NO.	UPC	DESCRIPTION	LENGTH	QTY	LBS
----------	-----	-------------	--------	-----	-----

.57" ID Tube - MIP x Compression



BWB25-18	026613100333	3/4" MIP X 5/8" OD Comp	18"	10	6.3
BWB28-18	026613965345	3/4" MIP x 7/8" OD Comp	18"	10	15.9
BWB28-24	026613965352	3/4" MIP x 7/8" OD Comp	24"	10	17.0

.57" ID Tube - FIP X PEX



BWB0-18PX	026613107141	3/4" FIP x 3/4" Nom PEX Barb	18"	10	6.8
-----------	--------------	------------------------------	-----	----	-----

.57" ID Tube - Push Connect X FIP



BWB0PS-12	026613166476	3/4" Push Connect x 3/4" FIP	12"	10	6.6
BWB0PS-15	026613166483	3/4" Push Connect x 3/4" FIP	15"	10	7.1
BWB0PS-18	026613166469	3/4" Push Connect x 3/4" FIP	18"	10	7.5
BWB0PS-24	026613166452	3/4" Push Connect x 3/4" FIP	24"	10	8.5

Copper-Flex™ Water Heater Connectors

Patented Resistance Against Galvanic Corrosion

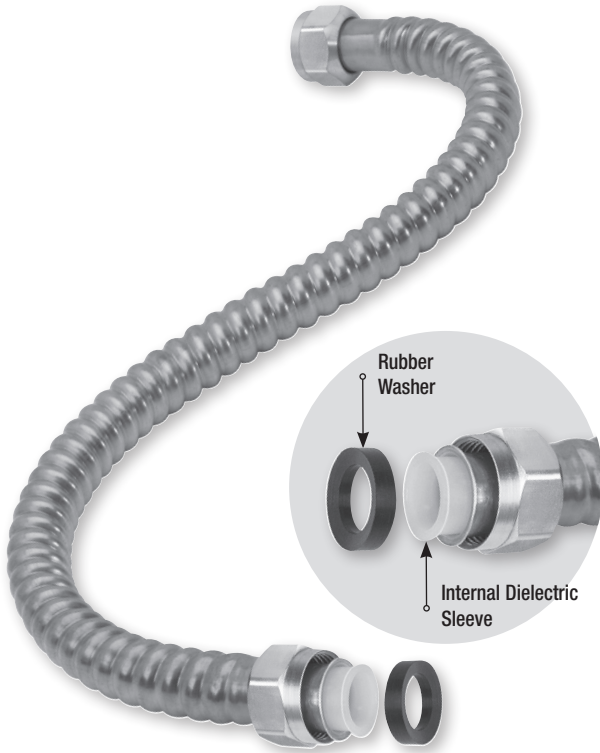

Internal Dielectric Sleeve

Effectively separates dissimilar metals within the waterway to prevent galvanic corrosion.

No Dielectric Union Needed*

Dielectric sleeve eliminates the need for a dielectric union (plastic lined nipple).

Low Torque to Seal

Pliant rubber washer seals well with minimal effort.

Longer Connector Nuts

A greater number of thread-to-thread contact provides a better seal to lined nipples.

Available for PEX connections



PART NO.	UPC	DESCRIPTION	LENGTH	QTY	LBS
7/8" OD Tube - FIP X FIP					
WB00-12N	026613089287	3/4" FIP x 3/4" FIP	12"	25	10.3
WB00-15N	026613089300	3/4" FIP x 3/4" FIP	15"	25	11.9
WB00-18N	026613089331	3/4" FIP x 3/4" FIP	18"	25	13.8
WB00-24N	026613089348	3/4" FIP x 3/4" FIP	24"	25	17.4
WB10-18N	026613131504	1" FIP x 3/4" FIP	18"	25	17.1



7/8" OD Tube - FIP x Male Sweat

WB03-15N	026613089379	3/4" FIP x 3/4" Nom Male Sweat (7/8" OD)	15"	25	10.3
WB03-18N	026613089386	3/4" FIP x 3/4" Nom Male Sweat (7/8" OD)	18"	25	12.2
WB03-24N	026613089393	3/4" FIP x 3/4" Nom Male Sweat (7/8" OD)	24"	25	15.8



7/8" OD Tube - FIP x Male/Female Sweat

WB034-12N	026613089409	3/4" FIP x 3/4" Nom Male/Female Sweat (7/8" ID)	12"	25	8.7
WB034-15N	026613089416	3/4" FIP x 3/4" Nom Male/Female Sweat (7/8" ID)	15"	25	10.3
WB034-18N	026613089423	3/4" FIP x 3/4" Nom Male/Female Sweat (7/8" ID)	18"	25	12.2
WB034-24N	026613093710	3/4" FIP x 3/4" Nom Male/Female Sweat (7/8" ID)	24"	25	15.8



⚠ WARNING: For use with water in accessible locations only. DO NOT use with gas – gas will cause corrosion and leakage.

*Check your local inspection office for applicable code requirements.

PART NO.	UPC	DESCRIPTION	LENGTH	QTY	LBS
----------	-----	-------------	--------	-----	-----

7/8" OD Tube - FIP x Male/Female Sweat (cont.)

 WB134-18N	026613110608	1" FIP x 3/4" Nom Male/Female Sweat (7/8" ID)	18"	25	15.5
WB134-24N	026613110615	1" FIP x 3/4" Nom Male/Female Sweat (7/8" ID)	24"	25	19.2

7/8" OD Tube - FIP x PEX Barb

 WB07-18	026613048871	3/4" FIP x 3/4" PEX Barb (brass, pre-torqued)	18"	25	16.5
WB07-24	026613100661	3/4" FIP x 3/4" PEX Barb (brass, pre-torqued)	24"	25	20.3

7/8" OD Tube - FIP/MIP x PEX Barb

 WB27-18	026613107950	3/4" FIP/MIP x 3/4" PEX Barb (brass, pre-torqued)	18"	25	21.1
---	--------------	---	-----	----	------

7/8" OD Tube - FIP/MIP x FIP

 WB20-12N	026613108254	3/4" FIP/MIP x 3/4" FIP	12"	25	14.8
WB20-15N	026613110394	3/4" FIP/MIP x 3/4" FIP	15"	25	16.5
WB20-18N	026613097695	3/4" FIP/MIP x 3/4" FIP	18"	25	18.2
WB20-24N	026613097701	3/4" FIP/MIP x 3/4" FIP	24"	25	21.9

7/8" OD Tube - FIP/MIP x Male Sweat

 WB23-18N	026613094762	3/4" FIP/MIP x 3/4" Nom Male Sweat (7/8" OD)	18"	25	16.6
--	--------------	--	-----	----	------



7/8" OD Tube - FIP/MIP x Male/Female Sweat



 WB234-12N	026613093727	3/4" FIP/MIP x 3/4" Nom Male/Female Sweat (7/8" ID)	12"	25	13.2
WB234-15N	026613093734	3/4" FIP/MIP x 3/4" Nom Male/Female Sweat (7/8" ID)	15"	25	14.9
WB234-18N	026613093741	3/4" FIP/MIP x 3/4" Nom Male/Female Sweat (7/8" ID)	18"	25	16.6
WB234-24N	026613093758	3/4" FIP/MIP x 3/4" Nom Male/Female Sweat (7/8" ID)	24"	25	20.3

7/8" OD Tube - Female Sweat x Female Sweat

 WC44-12	026613008301	3/4" Nom Female Sweat (7/8" ID) x 3/4" Nom Female Sweat (7/8" ID)	12"	25	7.1
WC44-15	026613008318	3/4" Nom Female Sweat (7/8" ID) x 3/4" Nom Female Sweat (7/8" ID)	15"	25	8.7
 WC44-18	026613008325	3/4" Nom Female Sweat (7/8" ID) x 3/4" Nom Female Sweat (7/8" ID)	18"	25	10.6
WC44-24	026613008332	3/4" Nom Female Sweat (7/8" ID) x 3/4" Nom Female Sweat (7/8" ID)	24"	25	14.2
WC66-12	026613008424	1/2" Nom Female Sweat (5/8" ID) x 1/2" Nom Female Sweat (5/8" ID)	12"	25	7.0

7/8" OD Tube - Female Sweat x Male Sweat

 WC43-15	026613008271	3/4" Nom Female Sweat (7/8" ID) x 3/4" Nom Male Sweat (7/8" OD)	15"	25	8.7
WC43-18	026613008288	3/4" Nom Female Sweat (7/8" ID) x 3/4" Nom Male Sweat (7/8" OD)	18"	25	10.6
 WC43-24	026613008295	3/4" Nom Female Sweat (7/8" ID) x 3/4" Nom Male Sweat (7/8" OD)	24"	25	14.2
WC65-15	026613008394	1/2" Nom Female Sweat (5/8" ID) x 1/2" Nom Male Sweat (5/8" OD)	15"	25	8.6
WC65-18	026613008400	1/2" Nom Female Sweat (5/8" ID) x 1/2" Nom Male Sweat (5/8" OD)	18"	25	10.5
WC65-24	026613008417	1/2" Nom Female Sweat (5/8" ID) x 1/2" Nom Male Sweat (5/8" OD)	24"	25	14.1

PART NO.	UPC	DESCRIPTION	LENGTH	QTY	LBS	
7/8" OD Tube - Male Sweat x Male Sweat						
WC33-18	026613008226	3/4" Nom Male Sweat (7/8" OD) x 3/4" Nom Male Sweat (7/8" OD)	18"	25	10.6	
WC33-24	026613008233	3/4" Nom Male Sweat (7/8" OD) x 3/4" Nom Male Sweat (7/8" OD)	24"	25	14.2	
7/8" OD Tube - Female Sweat x Male Sweat						
WC43-12	026613008264	3/4" Nom Female Sweat (7/8" ID) x 3/4" Nom Male Sweat (7/8" OD)	12"	25	7.1	
7/8" OD Tube - Male Sweat x Male Sweat						
WC55-18	026613008363	1/2" Nom Male Sweat (5/8" OD) x 1/2" Nom Male Sweat (5/8" OD)	18"	25	10.5	

ProCoat® Coated Stainless Steel Water Heater Connectors

Greater Flexibility, Superior Corrosion Resistance

Exclusive ProCoat® Clear Coat

Provides superior corrosion resistance to deterioration from most harsh chemicals that can cause pinhole leaks.

Full Flow, Maximum Performance

With 3/4" full flow internal diameter, our connectors provide greater water flow without obstruction.

Integrated Dielectric Sleeve

Isolates dissimilar metals within the waterway, where galvanic and electrolytic corrosion have their greatest potential.

No Dielectric Union Needed*

Integrated dielectric sleeve eliminates the need to install an additional dielectric union, reducing time and installation costs.

100% Leak Tested

Each connector is leak tested to help ensure connector performance and reliability.

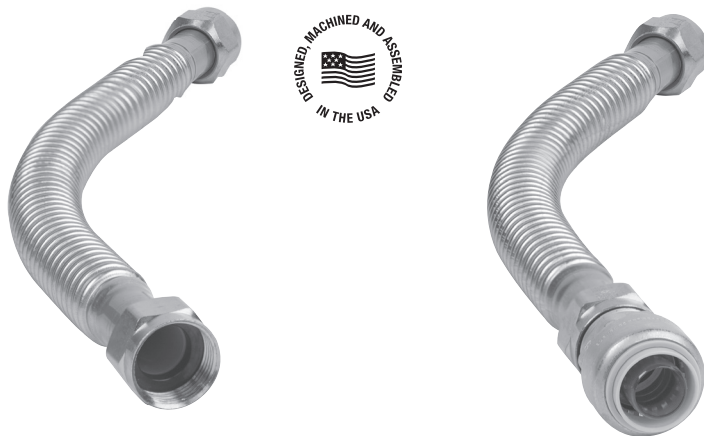

Push Connect

Compatible with Copper, PEX and CPVC

Installation Ready

Pre-inserted tube stiffener self aligns with the tubing to create a durable, watertight seal.

No Soldering or Glue Needed

Push Connect technology allows connecting with confidence for a fast, reliable, durable connection.



PART NO.	UPC	DESCRIPTION	LENGTH	QTY	LBS
3/4" ID Tube - FIP x FIP					
SWB00-12N	026613142562	(3/4" ID) 3/4" FIP x 3/4" FIP	12"	25	7.9
SWB00-15N	026613142579	(3/4" ID) 3/4" FIP x 3/4" FIP	15"	25	9.0
SWB00-18N	026613142586	(3/4" ID) 3/4" FIP x 3/4" FIP	18"	25	10.2
SWB00-24N	026613142593	(3/4" ID) 3/4" FIP x 3/4" FIP	24"	25	12.5

*BrassCraft Manufacturing Co. is in compliance with the National Reduction of Lead in Drinking Water Act. This legislation changed the legal definition of "lead free" from 8% lead to a weighted average lead content of 0.25% with respect to wetted surfaces.

▲ WARNING: For use with water in accessible locations only. DO NOT use with gas – gas will cause corrosion and leakage.

*Check your local inspection office for applicable code requirements.

PART NO.	UPC	DESCRIPTION	LENGTH	QTY	LBS
3/4" ID Tube - FIP x PEX Barb					
SWB07-18N	026613156781	(3/4" ID) 3/4" FIP x 3/4" PEX Barb (brass, pre-torqued)	18"	25	12.9
3/4" ID Tube - Push Connect X FIP					
SWB0PS-12N	026613166438	3/4" Push Connect x 3/4" FIP	12"	25	12.1
SWB0PS-15N	026613166445	3/4" Push Connect x 3/4" FIP	15"	25	13.3
SWB0PS-18N	026613165974	3/4" Push Connect x 3/4" FIP	18"	25	14.3
SWB0PS-24N	026613166421	3/4" Push Connect x 3/4" FIP	24"	25	16.6





PART NO.	UPC	DESCRIPTION	LENGTH	QTY	LBS
Adaptors					
WRU-12-12X	026613154213	Male Adaptor 3/4-14 Straight Male Pipe Thread x 3/4" MIP		25	4.5
WRU-16-12X	026613158440	Male Adaptor 3/4-14 Straight Male Pipe Thread x 1" MIP		10	3.0



WRU-12PXX	026613158518	3/4" MIP X 3/4" Nom PEX Brass Barb		10	1.1
-----------	--------------	------------------------------------	--	----	-----



Pipe Reducer Bushings					
PRB-12-8X	026613151281	3/4" MIP x 1/2" FIP		5	5 .4



Water Heater Connector Washers					
WRJ	026613051963	Washer 1.020" OD x .687" ID x .240" Thick. For Copper Connectors with an Internal Dielectric Sleeve		25	.1
WRJ-22	026613170862	Washer 1.220" OD x .687" ID x .225" Thick. For Wtr Htr Connectors with an Internal Dielectric Sleeve		25	.2



WWCD	026613051970	Washer .940" OD x .675" ID x .218" Thick. For Copper Connectors with an External Dielectric Sleeve		25	.1
------	--------------	--	--	----	----



Removal Tool					
PCT-12	026613166490	3/4" Push Connect Removal Tool		100	2.4

PART NO.	DESCRIPTION
----------	-------------

Gas Connector Displays

BC202 LARGE DIAMETER GAS CONNECTOR RACK



Signage / Literature

BC203 WATER HEATER CONNECTOR RACK W/PROCOAT AND COPPER-FLEX HEADER - 6.5" HIGH x 5.5" WIDE



Merchandising Aides

DD6000 WIRE BROCHURE HOLDER - 5" HIGH x 4.25" WIDE x 2.75" DEEP



DIH824 AISLE HEADER PLASTIC MOUNTING FRAME - 8.5" HIGH x 24.25" WIDE



SAFETY+PLUS® GAS APPLIANCE CONNECTORS w/EXCESS FLOW VALVE

Use: For use with indoor and outdoor connections of gas appliances to gas piping system. May be used with natural, manufactured, mixed and liquefied petroleum (LP or propane) gases, and LP gas-air mixtures.

Excess Flow Valve (EFV) Design Features:

- **Helps prevent gas fires and explosions** due to gas line ruptures or disconnects at the appliance
- **Automatic valve activation** immediately restricts gas flow to a non-hazardous level to help avert a dangerous build up of gas in the home
- **Automatic reset** once the gas line has been properly repaired
- **100% performance tested**

Connector Design Features:

- **Superior corrosion resistance** coating to protect against harsh chemicals found in most common household cleaning, plumbing repair, and masonry products
- **UV rays and salt resistant**, ProCoat® gas connectors are certified for indoor and outdoor use
- **100% leak tested**

Operating Specifications:

Temperature: 32° - 150° F
Pressure: 1/2 PSI maximum

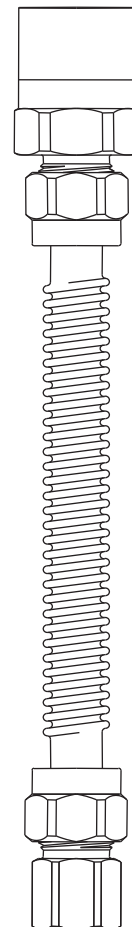

MATERIAL SPECIFICATIONS

Tubing	Stainless steel
Coating	Polymer blend
Nut	Steel
Standard Fitting	Steel

CONNECTOR FLOW CAPACITY – NATURAL GAS (Straight Length)

MODEL	ID	12"	18"	24"	30"	36"	48"	60"	72"
CSSC	1/2"	122,000	118,000	115,000	111,000	105,000	106,000	93,200	86,000
CSSD	3/8"	102,000	93,100	85,000	77,100	71,100	60,500	53,200	49,100
CSSL	1/4"	42,000	37,400	36,800	36,400	33,400	28,300	24,900	23,100

CONNECTOR FLOW CAPACITY - LPG (PROPANE) (Straight Length)

MODEL	ID	12"	18"	24"	30"	36"	48"	60"	72"
CSSC	1/2"	195,200	188,800	184,000	176,700	168,000	169,600	149,120	137,600
CSSD	3/8"	163,200	148,960	136,000	123,360	113,760	96,800	85,120	78,560
CSSL	1/4"	67,200	59,840	58,880	58,240	53,440	45,280	39,840	36,960

Listings & Certifications:

- Components CSA listed to ANSI Z21.24 / CSA 6.10 standard "Connectors for Gas Appliances" (file #204593)
- Components CSA listed to ANSI Z21.75 / CSA 6.27 standard "Connectors for Outdoor Gas Appliances & Manufactured Homes" (file #204593)
- CSA listed to ANSIZ21.93 / CSA 6.30 standard "Excess Flow Valves for Natural Gas with Pressures up to 5 PSI"



PROCOAT® GAS APPLIANCE CONNECTORS

Use: For use with indoor and outdoor connections of gas appliances to gas piping system. May be used with natural, manufactured, mixed and liquefied petroleum (LP or propane) gases, and LP gas-air mixtures.

Design Features:

- **Corrosion resistant** coating to protect against harsh chemicals found in most common household cleaning, plumbing repair, and masonry products
- **UV rays and salt resistant**, ProCoat® gas connectors are certified for indoor and outdoor use
- **100% leak tested**

Operating Specifications:

Temperature: -40° - 150° F
Pressure: 1/2 PSI maximum

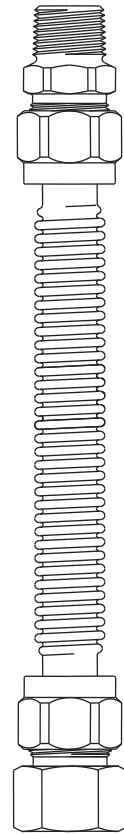

MATERIAL SPECIFICATIONS	
Tubing	<i>Stainless steel</i>
Coating	<i>Polymer blend</i>
Nut	<i>Steel</i>
Fitting	<i>Steel</i>

CONNECTOR FLOW CAPACITY – NATURAL GAS (Straight Length)									
MODEL	ID	12"	18"	24"	30"	36"	48"	60"	72"
CSSB	3/4"	290,900	290,900	290,900	270,500	255,900	215,000	197,400	173,900
CSSC	1/2"	180,000	164,200	150,000	136,000	125,000	106,000	93,200	86,000
CSSD	3/8"	102,000	93,100	85,000	77,100	71,100	60,500	53,200	49,100
CSSL	1/4"	48,000	43,800	40,000	36,400	33,400	28,300	24,900	23,100

CONNECTOR FLOW CAPACITY - LPG (PROPANE) (Straight Length)									
MODEL	ID	12"	18"	24"	30"	36"	48"	60"	72"
CSSB	3/4"	465,440	465,440	465,440	432,800	409,440	344,000	315,840	278,240
CSSC	1/2"	288,000	262,720	240,000	217,600	200,000	169,600	149,120	137,600
CSSD	3/8"	163,200	148,960	136,000	123,360	113,760	96,800	85,120	78,560
CSSL	1/4"	76,800	70,080	64,000	58,240	53,440	45,280	39,840	36,960

Listings & Certifications:

- CSA listed to ANSI Z21.24 / CSA 6.10 standard "Connectors for Gas Appliances"
- CSA listed to ANSI Z21.75 / CSA 6.27 standard "Connectors for Outdoor Gas Appliances & Manufactured Homes" (file #204593)
- The Commonwealth of Massachusetts



TANKLESS WATER HEATER SERVICE VALVES

Use: For use only in potable water distribution systems. Valves are used for water flow control to and from tankless water heater for maintenance of the appliance and emergency shut-off. Valves connect directly to cold water inlet and hot water outlet of the tankless water heater.

Design Features:

- **Compact design** ideal for recessed and cover box installations
- **Captive coupling nut and washer** reduces opportunity for component loss making installation easier
- **Captive washer** won't kink or tear during installation
- **Forged, one-piece construction** reduces the potential for pinhole leaks commonly associated with cast products
- **Integrated drain valve** with independent, 1/4 turn operation allows quick system diagnostic testing and maintenance
- **Built-in side port** for the pressure relief valve reduces the number of connections and simplifies the installation
- **Right-sized handles, color-coded** for immediate system identification. Perfect for tight installations

**Operating Specifications:**

Temperature: 40° - 180° F
Pressure: 125 PSI maximum

MATERIAL SPECIFICATIONS	
Valve Body	Low-lead forged brass
Stem	Low-lead brass
Handle	Aluminum, coated
Handle Screw	Steel, zinc plated
Flat Seal	Rubber
Coupling Nut	Forged brass
Drain Cap	Forged brass
Cap Gasket	Rubber
Seat	PTFE
Ball	Low-lead brass, chrome plated

Listings and Certifications:

- CSA verified to WOG 600 rating
- IAPMO listed to NSF/ANSI 61 (file #N-5427) and IGC 157
- No-lead product CSA listed to Low-lead Content Certification Program Plumbing Products Class 6853-01, including NSF/ANSI 372

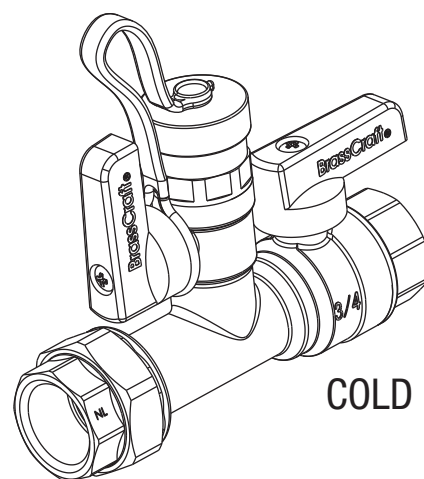
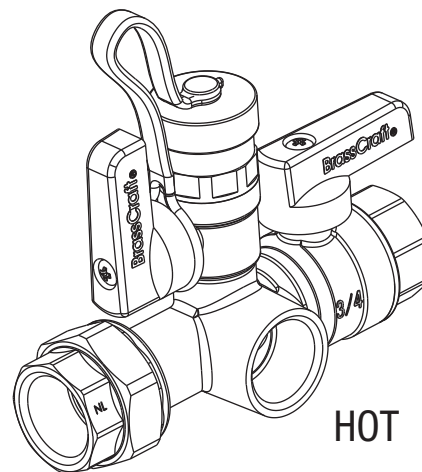

FULL-PORT GAS BALL VALVE

Use: For use with natural, manufactured, mixed, liquefied petroleum (LP) gas, and LP gas-air mixtures.

The National Fuel Gas Code requires a gas shut-off valve installed upstream, within “easy reach” or 6 feet of the gas appliance

Design Features:

- **Heavy duty forged brass body helps reduce** pinhole leaks commonly associated with cast products
- **Blow-out resistant stem** is assembled from the inside with double o-rings to provide reliable performance
- **Right-sized handle** helps ensure easy on/off operation even in tight installations
- **Quarter turn operation** for easy on/off flow control
- **Full flow operation.** Full port design provides abundant water flow without obstruction
- **Approved for indoor/outdoor use**

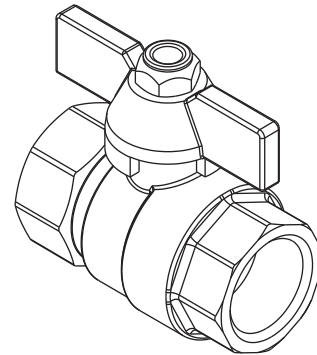

Operating Specifications:

Temperature: -40° - 125° F
Pressure: 5 PSI maximum

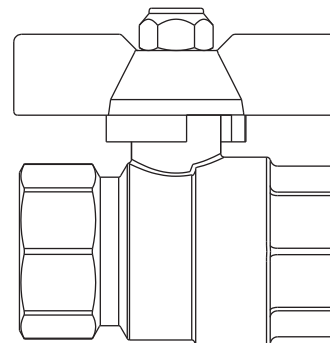

MATERIAL SPECIFICATIONS	
Valve Body	Forged brass
Retainer	Forged brass
Ball	Brass, chrome plated
Seat	PTFE
Stem	Brass
O-ring	High-temperature rubber
Washer	PTFE
Handle	Aluminum, coated
Nut	Steel, zinc plated

Listings and Certifications:

- CSA listed to ANSI Z21.15 / CSA 9.1, ANSI / ASME B16.44 and CGA CR91-002



GAS BALL VALVES

Use: For use with natural, manufactured, mixed, liquefied petroleum (LP) gas, and LP gas-air mixtures.

The National Fuel Gas Code requires a gas shut-off valve installed upstream, within "easy reach" or 6 feet of the gas appliance

Design Features:

- **Heavy duty forged brass body** helps reduce pinhole leaks commonly associated with cast products
- **Blow-out resistant stem** is assembled from the inside with double o-rings for reliable performance
- **Right-sized handle** helps ensure easy on/off operation even in tight installations
- **Quarter turn operation** for easy on/off flow control
- **PTFE seat** for longer life and consistent performance
- **Approved for indoor/outdoor use**
- **100% leak tested**

Operating Specifications:

Temperature: -40° - 125° F*

Pressure: 5 PSI maximum

* TBV6F-8, TBV10-12, and TBVA10-12 are rated for 32°-125° F

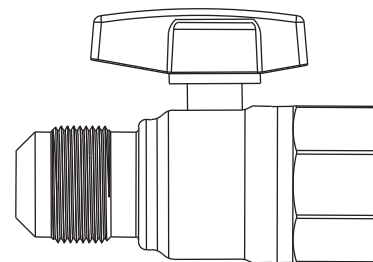
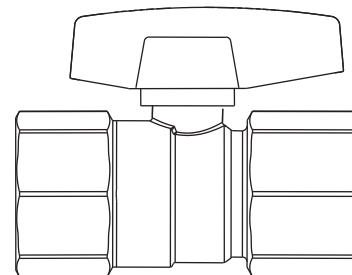
**MATERIAL SPECIFICATIONS**

Valve Body	Forged brass
Retainer	Forged brass
Ball	Brass, plated
Seat	PTFE
Stem	Brass
O-ring	High-temperature rubber
Handle	Aluminum, coated
Screw	Steel, plated

Listings and Certifications:

- CSA listed to ANSI Z21.15 / CSA 9.1, ANSI / ASME B16.44 and CGA CR91-002



GAS FITTINGS

Use: For use with natural, manufactured, mixed, liquefied petroleum gases, and LP gas-air mixtures.

Design Features:

- **One-piece body** provides strength, durability, and long-lasting performance
- **Manufactured with** dryseal pipe threads.

Operating Specifications:

Temperature: -40° - 150° F
Pressure: 1/2 PSI maximum

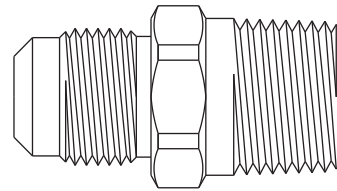
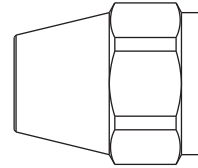

FITTING MATERIAL SPECIFICATIONS	
Brass Fitting	<i>Brass</i>
Steel Fitting	<i>Plated steel</i>

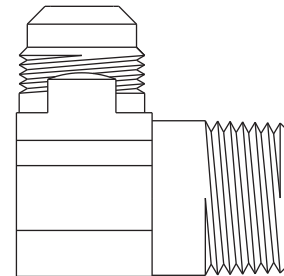
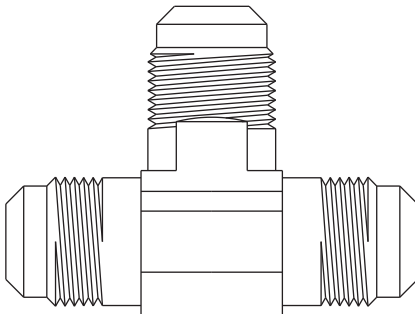

Listings & Certifications:

- For use with CSA listed ANSI Z21.24 / CSA 6.10 connectors
- For use with CSA listed ANSI Z21.75 / CSA 6.27 connectors

SPEEDI PLUMB® PLUS POLYMER BRAIDED WATER HEATER CONNECTORS

Use: For use only in exposed locations to connect water heaters and other water connected devices to the water supply. Not intended for use with recirculating water systems that produce continuous use temperatures above 115° F. For those applications use the BrassCraft® CopperFlex™ or ProCoat® series connectors.

Design Features:

- **Corrosion resistance** to harsh chemicals found in most common household cleaning, plumbing repair and masonry products when compared to stainless steel braided connectors.
- **Greater strength & flexibility.** The polymer braid exhibits superior elasticity, significantly increasing the flexibility of the connector when compared to stainless steel braiding.
- **No kinking, no crimping.** The polymer braided jacket is specially engineered to bend freely without kinking or crimping the connector
- **Won't work harden** even with repeated bending
- **No dielectric union needed** with installation as the braiding and rubber are constructed of non-conductive materials*
- **Longer connector nuts** allow a greater number of thread-to-thread contact and a better seal.

Operating Specifications:

Temperature: 40° - 160° F, intermittent to 180° F

Pressure: 125 PSI maximum

OPERATING SPECIFICATION				
	12"	15"	18"	24"
Flow Coefficient (Cv)	5.9	5.8	5.6	5.4

ΔP (Pressure Drop) = GPM^2 / Cv^2 for Example: 24" length connector @ 10 GPM

$$\Delta P = 10^2 / 5.4^2 = 100 / 29.16 = 3.43 \text{ psi}$$

MATERIAL SPECIFICATIONS	
Inner Hose	Rubber
Braiding	Coated polyester yarn
Barb	Brass
Ferrule	Brass
Nut	Brass
End Fitting	Brass
Washer	Rubber

Listings & Certifications:

- IAPMO listed to ASME A112.18.6 / CSA B125.6

*Check with your local inspection office for applicable code requirements

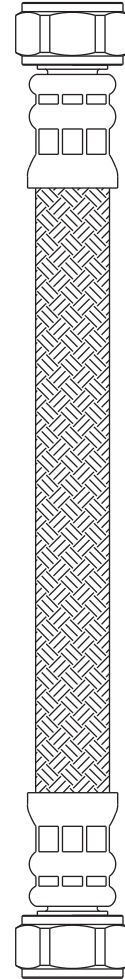

COPPER WATER HEATER CONNECTORS

Use: For use only in exposed locations to connect water heaters and other water connected devices to the water supply.

Design Features:

- **Built-in galvanic corrosion resistance.** Internal dielectric sleeve effectively isolates dissimilar metals within the waterway to prevent galvanic corrosion
- **No dielectric union needed** with installation. Dielectric is built into the design of the connector*
- **Nut provides** full thread engagement resulting in secure connection

Operating Specifications:

Temperature: 40° - 180° F
Pressure: 125 PSI maximum

MATERIAL SPECIFICATIONS	
Tubing	Copper
Dielectric Sleeve	Polypropylene
Nut	Brass
End Fitting	Brass
Washer	Rubber

Listings & Certifications:

- IAPMO listed to ASME A112.18.6 / CSA B125.6



*Check with your local inspection office for applicable code requirements

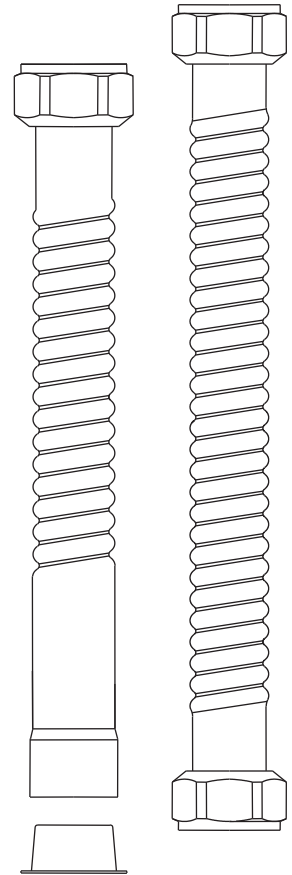

PROCOAT® STAINLESS STEEL WATER HEATER CONNECTORS

Use: For use only in exposed locations to connect water heaters, water softeners, and other water connected devices to the water supply.

Design Features:

- **Corrosion resistant** coating to protect against harsh chemicals found in most common household cleaning, plumbing repair, and masonry products
- **Maximum performance.** ¾" internal diameter provides greater water flow without obstruction
- **Integrated dielectric sleeve** effectively isolates dissimilar metals within the waterway to help prevent galvanic and electrolytic corrosion
- **No dielectric union needed** with installation. Dielectric is built into the design of the connector*
- **Nut provides** full thread engagement resulting in a secure connection
- **100% leak tested** prior to coating application to help ensure connector performance and reliability

Operating Specifications:

Temperature: 40° - 180° F

Pressure: 125 PSI maximum

MATERIAL SPECIFICATIONS	
Tube	<i>Stainless steel</i>
Dielectric Sleeve	<i>Polypropylene</i>
Nut	<i>Brass, chrome plated</i>
Washer	<i>Rubber</i>

Listings & Certifications:

- IAPMO listed to ASME A112.18.6 / CSA B125.6

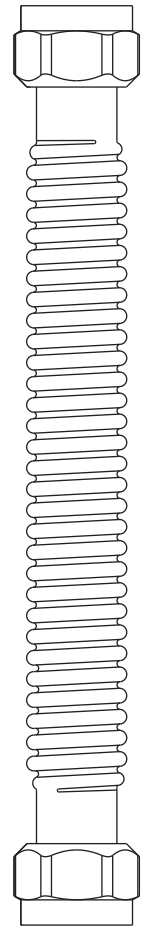

*Check with your local inspection office for applicable code requirements

PART NO.	PAGE	PART NO.	PAGE	PART NO.	PAGE
40-6	31	BCSSL44-18	21	BWB28-18	36
40-8	31	BCSSL44-24	21	BWB28-24	36
41S-6	32	BCSSL47-12	21	CSSB11-12	11
41S-8	31	BCSSL47-18	21	CSSB11-18	11
ASN-10	31	BCSSL47-24	21	CSSB11-24	11
AU1-14-12	30	BCSSL4M-12	22	CSSB11-30	11
AU1-6-8S	31	BCSSL4M-18	22	CSSB11-36	11
AU1-8-12S	31	BCSSL4M-24	22	CSSB11-48	11
AU1-8S	31	BCSSL4M-30	22	CSSB11-60	11
AU2-14-12	30	BCSSL54-18	21	CSSB1412-12	11
AU2-14-16	30	BCSSL54-24	21	CSSB1412-18	11
AU2-6-8S	31	BCSSL7M-12	21	CSSB1412-24	11
AU2-6S	31	BCSSL7M-18	21	CSSB1412-36	11
AU2-8-12S	31	BCSSL7M-30	21	CSSB21-12	11
AU2-8-6S	31	BCSSL87-12	22	CSSB21-18	11
AU2-8S	31	BCSSL87-18	22	CSSB21-24	11
AU6-8-6 P	31	BCSSL87-24	22	CSSB21-30	11
AU7-10-8 P	30	BCSSL87-30	22	CSSB21-36	11
BC202	43	BCSSL8M-18	22	CSSB21-48	11
BC203	43	BCSSL8M-24	22	CSSB21-60	11
BCSSD44-18	21	BCSSL8M-30	22	CSSB21-72	11
BCSSD44-24	21	BWB0-12	35	CSSB22-12	12
BCSSD44-30	21	BWB0-15	35	CSSB22-18	12
BCSSD47-12	21	BWB0-18	35	CSSB22-24	12
BCSSD47-18	21	BWB0-18PX	36	CSSB22-30	12
BCSSD47-24	21	BWB0-24	35	CSSB22-36	12
BCSSD47-30	21	BWB05-18	35	CSSB22-48	12
BCSSD4K-12	21	BWB08-12	35	CSSB22-60	12
BCSSD4K-18	21	BWB08-18	35	CSSB22-72	12
BCSSD4K-30	21	BWB08-24	35	CSSC11-12	12
BCSSD54-12	21	BWB0PS-12	36	CSSC11-18	12
BCSSD54-18	21	BWB0PS-15	36	CSSC11-24	12
BCSSD54-24	21	BWB0PS-18	36	CSSC11-30	12
BCSSD54-36	21	BWB0PS-24	36	CSSC11-36	12
BCSSD55-18	21	BWB20-12	35	CSSC11-48	12
BCSSD55-24	21	BWB20-15	35	CSSC11-60	12
BCSSD5K-12	21	BWB20-18	35	CSSC11-72	12
BCSSD5K-24	21	BWB20-24	35	CSSC11R-12	7
BCSSD5K-30	21	BWB20-60	35	CSSC11R-18	7
BCSSL44-12	21	BWB25-18	36	CSSC11R-24	7

PART NO.	PAGE	PART NO.	PAGE	PART NO.	PAGE
CSSC11R-30	7	CSSC21-30	13	CSSC24R-24	7
CSSC14-12	12	CSSC21-36	13	CSSC24R-30	7
CSSC14-18	12	CSSC21-48	13	CSSC24R-36	7
CSSC14-24	12	CSSC21-60	13	CSSC24R-48	7
CSSC14-30	12	CSSC21-72	13	CSSC24R-72	7
CSSC14-36	12	CSSC21R-12	7	CSSC25-12	13
CSSC14-48	12	CSSC21R-18	7	CSSC25-18	13
CSSC14-60	12	CSSC21R-24	7	CSSC25-24	13
CSSC14-72	12	CSSC21R-30	7	CSSC25-30	13
CSSC14R-12	7	CSSC21R-36	7	CSSC25-36	13
CSSC14R-18	7	CSSC21R-48	7	CSSC25-48	13
CSSC14R-24	7	CSSC22-12	13	CSSC25-60	13
CSSC14R-30	7	CSSC22-18	13	CSSC25-72	13
CSSC14R-48	7	CSSC22-24	13	CSSC2J-12	15
CSSC15-12	12	CSSC22-30	13	CSSC2J-18	15
CSSC15-18	12	CSSC22-36	13	CSSC2J-24	15
CSSC15-24	12	CSSC22-48	13	CSSC2J-30	15
CSSC15-30	12	CSSC22-60	13	CSSC2J-36	15
CSSC15-36	12	CSSC22-72	13	CSSC2J-48	15
CSSC15-48	12	CSSC22R-12	7	CSSC2J-60	15
CSSC15-60	12	CSSC22R-18	7	CSSC2J-72	15
CSSC15-72	12	CSSC22R-24	7	CSSC2P-12	15
CSSC1J-12	14	CSSC22R-30	7	CSSC2P-18	15
CSSC1J-18	14	CSSC22R-48	7	CSSC2P-24	15
CSSC1J-24	14	CSSC22R-60	8	CSSC2P-30	15
CSSC1J-30	14	CSSC22R-72	8	CSSC2P-36	15
CSSC1J-36	14	CSSC23-24	14	CSSC2P-48	15
CSSC1J-48	14	CSSC23-36	14	CSSC2P-60	15
CSSC1J-60	14	CSSC23-48	14	CSSC44-12	12
CSSC1J-72	14	CSSC23-72	14	CSSC44-18	12
CSSC1P-12	14	CSSC24-12	13	CSSC44-24	12
CSSC1P-18	14	CSSC24-18	13	CSSC44-30	12
CSSC1P-24	14	CSSC24-24	13	CSSC44-36	12
CSSC1P-30	14	CSSC24-30	13	CSSC44-48	12
CSSC1P-36	14	CSSC24-36	13	CSSC44-60	12
CSSC1P-48	14	CSSC24-48	13	CSSC44-72	12
CSSC1P-60	14	CSSC24-60	13	CSSC44R-12	7
CSSC21-12	13	CSSC24-72	13	CSSC44R-18	7
CSSC21-18	13	CSSC24R-12	7	CSSC44R-24	7
CSSC21-24	13	CSSC24R-18	7	CSSC44R-30	7

PART NO.	PAGE	PART NO.	PAGE	PART NO.	PAGE
CSSC44R-48	7	CSSC54R-72	7	CSSD44-18	15
CSSC44R-60	7	CSSC55-12	13	CSSD44-24	15
CSSC44R-72	7	CSSC55-18	13	CSSD44-30	15
CSSC4J-12	14	CSSC55-24	14	CSSD44-36	15
CSSC4J-18	14	CSSC55-30	14	CSSD44-48	15
CSSC4J-24	14	CSSC55-36	14	CSSD44-60	15
CSSC4J-30	14	CSSC55-48	14	CSSD44-72	15
CSSC4J-36	14	CSSC55-60	14	CSSD44R-12	9
CSSC4J-48	14	CSSC55-72	14	CSSD44R-18	9
CSSC4J-60	14	CSSC55R-12	8	CSSD44R-24	9
CSSC4J-72	14	CSSC55R-18	8	CSSD44R-30	9
CSSC4K-12	14	CSSC55R-30	8	CSSD44R-36	9
CSSC4K-18	14	CSSC55R-48	8	CSSD44R-48	9
CSSC4K-24	14	CSSC55R-60	8	CSSD44R-60	9
CSSC4K-30	14	CSSC55R-72	8	CSSD44R-72	9
CSSC4K-36	14	CSSC91R-12	8	CSSD45R-12	9
CSSC4K-48	14	CSSC91R-18	8	CSSD45R-18	9
CSSC4K-60	14	CSSC91R-24	8	CSSD45R-24	9
CSSC4P-12	14	CSSC91R-30	8	CSSD45R-30	9
CSSC4P-18	15	CSSC91R-36	8	CSSD45R-36	9
CSSC4P-24	15	CSSC91R-48	8	CSSD45R-48	9
CSSC4P-30	15	CSSC91R-60	8	CSSD45R-60	9
CSSC4P-36	15	CSSC91R-72	8	CSSD45R-72	9
CSSC4P-48	15	CSSC94R-12	8	CSSD47-12	15
CSSC4P-60	15	CSSC94R-18	8	CSSD47-18	15
CSSC4P-72	15	CSSC94R-24	8	CSSD47-24	15
CSSC54-12	13	CSSC94R-30	8	CSSD47-30	15
CSSC54-18	13	CSSC94R-36	8	CSSD47-36	15
CSSC54-24	13	CSSC94R-48	8	CSSD47-48	15
CSSC54-30	13	CSSC94R-60	8	CSSD47-60	15
CSSC54-36	13	CSSC94R-72	8	CSSD47-72	15
CSSC54-48	13	CSSCJ4R-12 P20	8	CSSD48-12	16
CSSC54-60	13	CSSCJ4R-18 P20	8	CSSD48-18	16
CSSC54-72	13	CSSCJ4R-36 P20	8	CSSD48-24	16
CSSC54R-12	7	CSSCJ4R-60 P12	8	CSSD48-30	16
CSSC54R-18	7	CSSCJ4R-72 P12	8	CSSD48-36	16
CSSC54R-24	7	CSSCK4R-12 P20	8	CSSD48-48	16
CSSC54R-30	7	CSSCK4R-18 P20	8	CSSD48-60	16
CSSC54R-48	7	CSSCK4R-60 P12	8	CSSD48-72	16
CSSC54R-60	7	CSSD44-12	15	CSSD4K-12	17

PART NO.	PAGE	PART NO.	PAGE	PART NO.	PAGE
CSSD4K-18	17	CSSD58-30	16	CSSL47-48	17
CSSD4K-24	17	CSSD58-36	17	CSSL47-60	17
CSSD4K-30	17	CSSD58-48	17	CSSL48-12	18
CSSD4K-36	17	CSSD58-60	17	CSSL48-18	18
CSSD4K-48	17	CSSD58-72	17	CSSL48-24	18
CSSD4K-60	17	CSSD5K-12	17	CSSL48-30	18
CSSD4K-72	17	CSSD5K-30	17	CSSL48-36	18
CSSD54-12	16	CSSD5K-36	17	CSSL48-48	18
CSSD54-18	16	CSSD5K-48	17	CSSL48-72	18
CSSD54-24	16	CSSD5K-60	17	CSSL48R-12	10
CSSD54-30	16	CSSD5K-72	17	CSSL48R-18	10
CSSD54-36	16	CSSD77-12	15	CSSL48R-30	10
CSSD54-48	16	CSSD77-18	16	CSSL48R-36	10
CSSD54-60	16	CSSD77-24	16	CSSL48R-60	10
CSSD54-72	16	CSSD77-30	16	CSSL48R-72	10
CSSD55-12	16	CSSD77-36	16	CSSL4M-12	19
CSSD55-18	16	CSSD77-48	16	CSSL4M-18	19
CSSD55-24	16	CSSD77-60	16	CSSL4M-24	19
CSSD55-30	16	CSSD77-72	16	CSSL4M-30	19
CSSD55-36	16	CSSDK4R-12 P20	9	CSSL4M-36	19
CSSD55-48	16	CSSDK4R-48 P20	9	CSSL4M-48	19
CSSD55-60	16	CSSDK4R-60 P12	9	CSSL4M-60	19
CSSD55-72	16	CSSDK4R-72 P12	9	CSSL4M-72	19
CSSD55R-12	9	CSSL44-12	17	CSSL54-12	18
CSSD55R-18	9	CSSL44-18	17	CSSL54-18	18
CSSD55R-24	9	CSSL44-24	17	CSSL54-24	18
CSSD55R-30	9	CSSL44-30	17	CSSL54-30	18
CSSD55R-36	9	CSSL44-36	17	CSSL54-36	18
CSSD55R-48	9	CSSL44-48	17	CSSL54-48	18
CSSD55R-60	9	CSSL44-60	17	CSSL54-60	18
CSSD55R-72	9	CSSL44-72	17	CSSL54-72	18
CSSD57-12	16	CSSL44R-18	9	CSSL55-12	18
CSSD57-18	16	CSSL44R-30	9	CSSL55-18	18
CSSD57-30	16	CSSL44R-36	9	CSSL55-24	18
CSSD57-48	16	CSSL44R-48	9	CSSL55-30	18
CSSD57-60	16	CSSL44R-60	9	CSSL55-36	18
CSSD57-72	16	CSSL44R-72	9	CSSL55-48	18
CSSD58-12	16	CSSL47-18	17	CSSL55-60	18
CSSD58-18	16	CSSL47-24	17	CSSL55-72	18
CSSD58-24	16	CSSL47-36	17	CSSL57-12	18

PART NO.	PAGE	PART NO.	PAGE	PART NO.	PAGE
CSSL57-18.....	18	CSSL88R-18.....	10	MAU1-10-12S.....	30
CSSL57-24.....	18	CSSL88R-30.....	10	MAU1-10-8S.....	30
CSSL57-30.....	18	CSSL88R-36.....	10	MAU2-10-12S.....	30
CSSL57-36.....	18	CSSL88R-60.....	10	MAU2-10-8S.....	30
CSSL57-48.....	18	CSSL88R-72.....	10	PCT-12.....	42
CSSL57-60.....	18	CSSL8M-24.....	19	PRB-12-8X.....	42
CSSL57-72.....	18	CSSL8M-30.....	19	PSB1096 L.....	23
CSSL77-18.....	17	CSSL8M-36.....	19	PSC1079.....	23
CSSL77-24.....	17	CSSL8M-48.....	19	PSC1085X L.....	23
CSSL77-30.....	17	CSSL8M-72.....	19	PSC1098 L.....	24
CSSL77-36.....	17	CSST44-24.....	19	PSC1106.....	24
CSSL77-48.....	17	CSST44-36.....	19	PSC1107.....	24
CSSL7M-12.....	19	CSST44-72.....	19	PSC1108X L.....	24
CSSL7M-18.....	19	CSST54-12.....	19	SWB00-12N.....	40
CSSL7M-24.....	19	CSST54-18.....	19	SWB00-15N.....	40
CSSL7M-36.....	19	CSST54-24.....	19	SWB00-18N.....	40
CSSL7M-48.....	19	CSST54-36.....	19	SWB00-24N.....	40
CSSL7M-60.....	19	CSST54-48.....	19	SWB07-18N.....	41
CSSL87-12.....	18	CSST58-18 P.....	20	SWBOPS-12N.....	41
CSSL87-18.....	18	CSST58-24 P.....	20	SWBOPS-15N.....	41
CSSL87-24.....	18	CSST58-36 P.....	20	SWBOPS-18N.....	41
CSSL87-30.....	18	CSST58-60 P.....	20	SWBOPS-24N.....	41
CSSL87-36.....	18	CSST58-72 P.....	20	TBV10-12.....	29
CSSL87-48.....	18	CSST87-18.....	20	TBV10-8.....	29
CSSL87-60.....	18	CSST87-36.....	20	TBV12.....	28
CSSL87-72.....	18	CSST87-60.....	20	TBV12F.....	28
CSSL87R-12.....	10	CSST88-36.....	20	TBV16.....	28
CSSL87R-18.....	10	CSST88-60.....	20	TBV6-8.....	29
CSSL87R-24.....	10	CSST88-72.....	20	TBV6F-8.....	29
CSSL87R-30.....	10	DD6000.....	43	TBV8.....	28
CSSL87R-36.....	10	DIH824.....	43	TBV8-8.....	29
CSSL87R-72.....	10	F0-6.....	33	TBVA10-12.....	29
CSSL88-12.....	18	FC-6.....	33	TBVA6-8.....	29
CSSL88-18.....	18	FRC16-6.....	33	TBVA8-6.....	28
CSSL88-24.....	18	FT3-6.....	33	TBVA8-8.....	29
CSSL88-30.....	19	FU3-6.....	33	TBVF10.....	29
CSSL88-36.....	19	LBV12.....	29	TBVF6.....	29
CSSL88-48.....	19	LBV8.....	29	TBVF8.....	29
CSSL88-60.....	19	M40-10.....	30	TK30RB21-18G3X.....	26
CSSL88R-12.....	10	MAE1-10-12.....	30	TK30RB21-18X.....	26

PART NO.	PAGE	PART NO.	PAGE	PART NO.	PAGE
TK30RB21-24G3X	26	WC44-12	38		
TK30RB21-24X.....	26	WC44-15	38		
TK3SRB21-18X.....	26	WC44-18.....	38		
TK3SRB21-24X.....	26	WC44-24.....	38		
TWV30RX.....	26	WC55-18.....	39		
TWV30X.....	26	WC65-15.....	38		
TWV3SRX	26	WC65-18.....	38		
TWV3SX.....	26	WC65-24.....	38		
WB00-12N.....	37	WC66-12.....	38		
WB00-15N.....	37	WRJ.....	42		
WB00-18N.....	37	WRJ-22	42		
WB00-24N.....	37	WRU-12-12X	42		
WB03-15N.....	37	WRU-12PXX.....	42		
WB03-18N.....	37	WRU-16-12X	42		
WB03-24N.....	37	WWCD	42		
WB034-12N.....	37				
WB034-15N.....	37				
WB034-18N.....	37				
WB034-24N.....	37				
WB07-18.....	38				
WB07-24.....	38				
WB10-18N.....	37				
WB134-18N.....	38				
WB134-24N.....	38				
WB20-12N.....	38				
WB20-15N.....	38				
WB20-18N.....	38				
WB20-24N.....	38				
WB23-18N.....	38				
WB234-12N.....	38				
WB234-15N.....	38				
WB234-18N.....	38				
WB234-24N.....	38				
WB27-18.....	38				
WC33-18.....	39				
WC33-24.....	39				
WC43-12.....	39				
WC43-15.....	38				
WC43-18.....	38				
WC43-24.....	38				



BrassCraft®



Brasscraft Manufacturing Co.
39600 Orchard Hill Place
Novi, Michigan 48375-5331
TOLL-FREE: (877) 272-7755
FAX: (248) 305-6011