

Aprilaire®

Model 8710 Wireless Thermostat

Safety & Installation Instructions

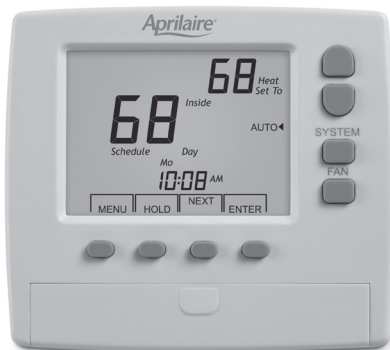

**READ AND SAVE
THESE INSTRUCTIONS**

TABLE OF CONTENTS

Application	3	11. Selecting Equipment Type	12
Features	3	12. Fan Operation	12
Specifications	3	13. Minimum Off Time	13
Control Module		14. Minimum Run Time	13
1. Installation	4	15. Heating Setpoint Limit	14
2. Wiring	4	16. Cooling Setpoint Limit	14
3. Location	6	17. Heat / Cool Setpoint Differential	15
4. Removing the Sub-Base	6	18. First Stage Differential	15
5. Installing the Sub-Base	7	19. Second Stage Differential	16
6. Installing the Batteries	7	20. Third Stage Differential	16
7. Thermostat Installer Options	8	21. Stage Timing	17
8. Setting the Zone Number	10	22. Calibrating the Temperature Sensor Offset	17
9. Setting the Home Number	10		
10. Programming the Control Module	11		

APPLICATION

The Model 8710 is a 7-day programmable, battery powered thermostat that communicates via an RF wireless data link to a control module located near the HVAC equipment.

The Model 8710 can control single stage, multi-stage and heat pumps with up to 3 stages of heating and 2 stages of cooling.

FEATURES

- Manual or programmable selection with up to four schedules per day.
- Wireless 915MHz proprietary protocol with up to 100' transmission range.
- Easy access, front-loading battery compartment. 2 AA batteries included.

SPECIFICATIONS

Compatible Equipment	Single stage, multi-stage and heat pumps (3 heat / 2 cool)
Output Terminals	W1/B, O, W2/E, Y1, Y2, G
Fan Operation	Gas or electric
LED Indicator	Multi-color indicates heating, cooling and fan calls
Communications	Wireless, 915MHz, proprietary protocol
Range	Up to 100 feet
Control Module Power	24VAC, 2.4VA
Control Module Housing	Molded plastic
Control Module Dimensions	5.09 x 2.65 x 1.10 inches (WHD)
Thermostat Dimensions	5.00 x 4.50 x 1.00 inches (WHD)

CONTROL MODULE

1 INSTALLATION

The control module should be installed close to the equipment being controlled. Do not install it within a metal enclosure that might interfere with wireless communications. Only standard 18 gauge thermostat wire is required to wire the module to the equipment.

Two #6 sheet metal mounting screws are included or the module can be installed with double-backed adhesive tape.

2 WIRING

The control module is powered by the 24VAC from HVAC system. The diagrams below show wiring when configured for Gas / Electric and Heat Pump systems. Refer to the wiring diagrams on the following page.

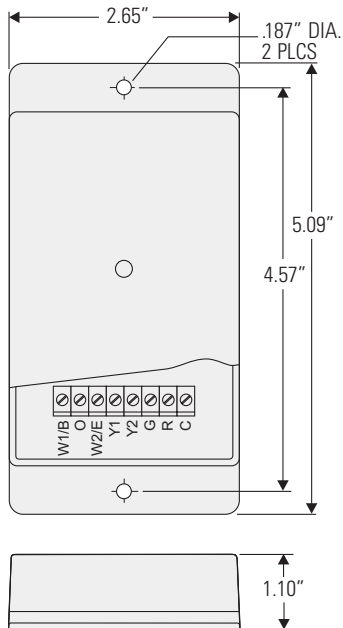

WIRING – GAS / ELECTRIC (UP TO 2 HEAT / 2 COOL)

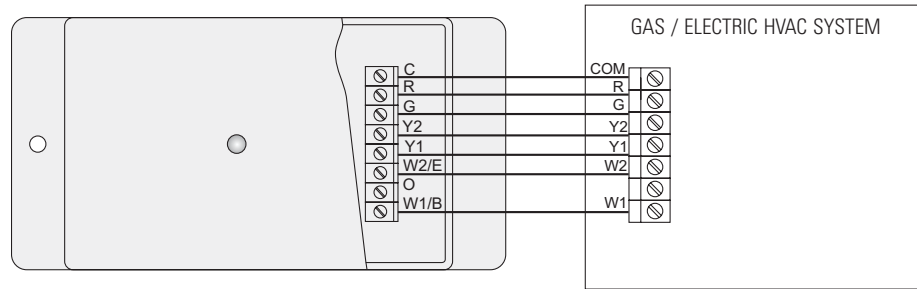

WIRING – HEAT PUMP (UP TO 3 HEAT / 2 COOL)

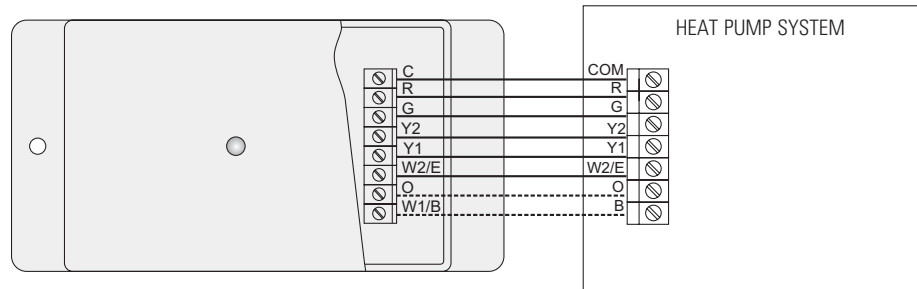

THERMOSTAT

3 LOCATION

The thermostat should be located in an area that represents the ambient space temperature and within 100 feet of the control module. Do not install the thermostat in an area where drafts are present, near the floor, behind doors or on an external wall. Avoid placing the thermostat in areas where the air movement is limited, affected by direct sunlight or other areas not typical of the temperature in the space.

4 REMOVING THE SUB-BASE

Hold the sub-base with one hand, press the case as shown below and pull the bottom of the thermostat from the sub-base. Refer to the illustrations to the right.

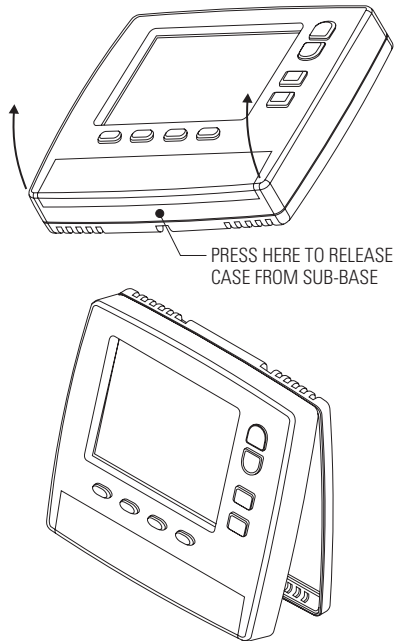

5 INSTALLING THE SUB-BASE

The thermostat should be installed approximately 5 feet above the floor.

Level the sub-base for appearance and use the wall anchors and screws provided.

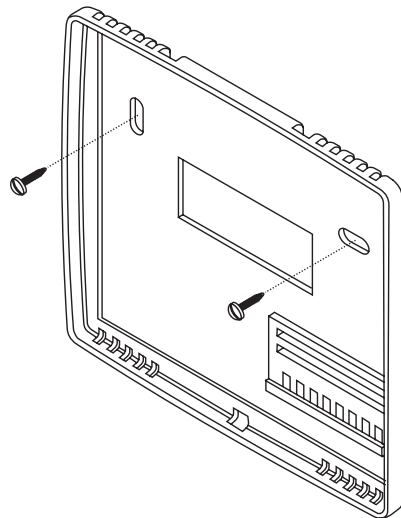

6 INSTALLING THE BATTERIES

Slide the battery cover off and install two AA batteries included with the thermostat. Install the batteries with the positive terminals to the right as shown. Replace the battery cover.

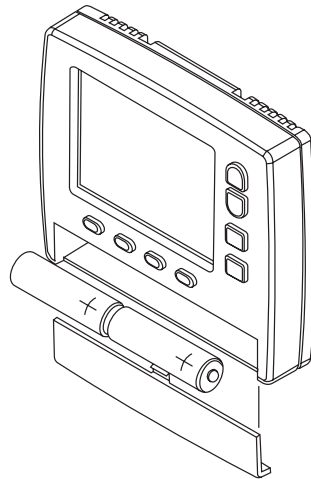

The LCD will display the time of day, the setpoint temperature and the room temperature.

7 THERMOSTAT INSTALLER OPTIONS

The installer options can be accessed by pressing and holding the **ENTER** key for seven seconds. The LCD displays Option 01 for setting the number. (See Installer Options Chart.)

Press or hold the **NEXT** key to advance to the next option. The LCD will advance through to Option 15 and then return to Option 01.

Press the **ENTER** key to save all options in nonvolatile flash ram.

If only one wireless thermostat and control module are used in an application, the thermostat can be left with the factory default setting of and **Zone = 01** and **Home = 01**.

If multiple wireless thermostats and control modules are used that are less than 500 feet away from one another, each thermostat must be set to a different Home number. For convenience, set the Installer Options with the thermostat off the subbase and in easy access of its control module.

RESETTING FACTORY DEFAULTS

To reset the factory defaults, remove the batteries and re-install them while holding down the **SYSTEM** key. All prior changes will default to the factory settings. This will require resetting the time of day and programming schedules if necessary. Refer to the Installer Options Chart default settings to make any additional changes.

INSTALLER OPTIONS CHART

Option	Description
01	Zone number Range 01 to 08 Default 01
02	Home number Range 01 to 32 Default 01
03	Program Control Module with Zone and Home address - Default 01
04	Equipment type Range 00- G/E 01- Heat Pump Default 00- G/E
05	Indoor Fan Operation Range 00- Gas 01- Electric Default 00- Gas
06	Minimum Off Time Range 01 to 09 minutes Default 00 minutes
07	Minimum Run Time Range 01 to 09 minutes Default 00 minutes
08	Maximum allowable heating setpoint Range 60 to 85F Default 85F

Option	Description
09	Minimum allowable cooling setpoint Range 55 to 80F Default 65F
10	Heat/Cool Setpoint Differential Range 02 to 06F Default 02F
11	Stage 1 Temperature Differential Range 01 to 04F Default 01F
12	Stage 2 Temperature Differential Range 01 to 10F Default 03F
13	Stage 3 Temperature Differential Range 01 to 12F Default 05F
14	Staging Time Range 0=OFF 1=ON Default 0
15	Staging Time When 14 = 1 (ON) Range 15 - 30 (1 Minute Increments) Default 15

8 SETTING THE ZONE NUMBER

Use the **Up** and **Down** keys to set the number for the each thermostat. The **Zone** number can be set from 01 to 08.

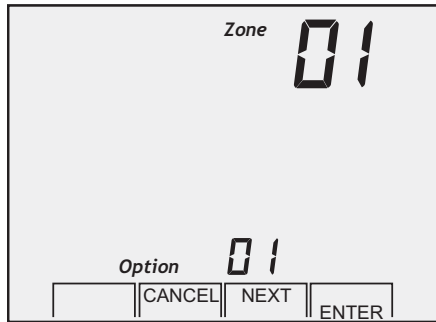

Zone Numbers can be used to identify individual thermostats. Press the **NEXT** key to advance to the next option. Press the **ENTER** key if no more options are to be changed.

9 SETTING THE HOME NUMBER

Press the **NEXT** key to select **Option 02**. The **Home** number is used to distinguish between thermostats and control modules that are less than 500 feet away from one another. This could be a home with two HVAC systems or a multi-family residence.

Use the **Up** and **Down** keys to set the **Home** number for the thermostat. The **Home** number can be set from 01 to 32. Skip this option if no other thermostats and modules are nearby.

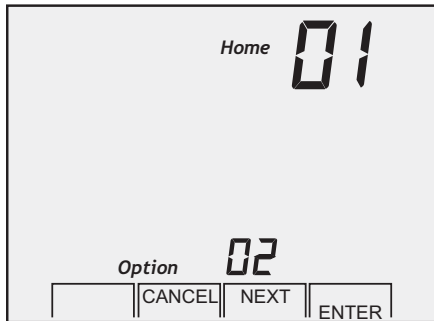

10 PROGRAMMING THE CONTROL MODULE

After selecting the Zone and Home numbers for the thermostat, the control module must be paired with the thermostat. Follow these steps:

1. Power the control module.
2. Press the program button on the control module, the LED will blink red and green. You have 30 seconds to complete the following steps:
3. On the thermostat enter the installer options (press and hold **ENTER**).
4. Press **NEXT** twice to select **Option 03** of the installer options (as shown below).
5. Press **ENTER** to complete the pairing. The thermostat will return to the home screen. The LED on the control module will stop flashing red and yellow and display the thermostats current state. The thermostat is now paired with the control module.

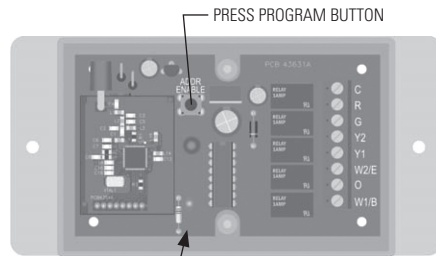
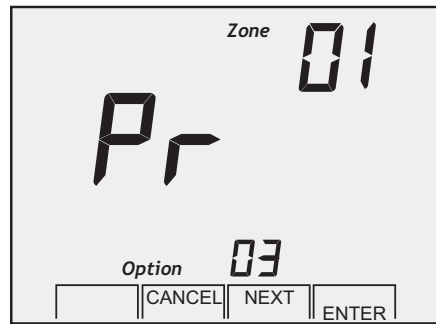

LED INDICATION

Flashing Green – No calls
Solid Yellow – First stage cooling
Flashing Yellow – Second stage cooling
Solid Red – First stage heating
Flashing Red – Second stage heating
Solid Green – Fan
Flashing Green & Red – No signal

11 SELECTING EQUIPMENT TYPE

The control module can be set for either gas/electric or heat pump operation. Press the **NEXT** key to select **Option 04** and press the **Up** or **Down** key to select 00 = Gas/Electric or 01 = Heat Pump operation.

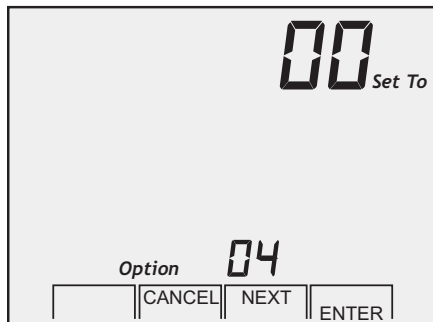

12 FAN OPERATION

Press the **NEXT** key to select **Option 05**. The fan can be set to 00 = Gas operation where the equipment activates the HVAC system fan during heating calls or to 01 = Electric operation where the module activates the fan during heating calls. In heat pumps and all cooling calls, the module activates the fan (G) terminal.

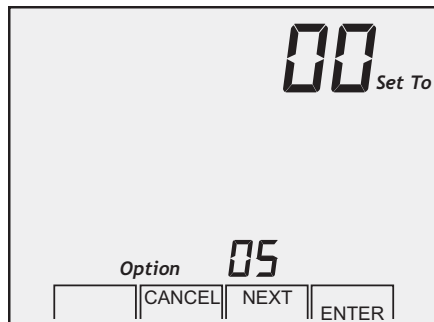

13 MINIMUM OFF TIME

The minimum Off time prevents the compressor from restarting too quickly. Large HVAC systems should use a longer Off time. The minimum Off time and the minimum Run time also influence the cycling rate.

Press the **NEXT** key to select **Option 06** and press the **Up** or **Down** key to set the Minimum Off Time.

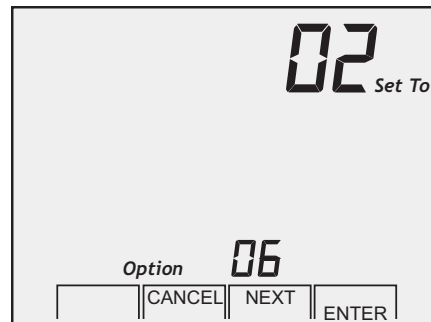

14 MINIMUM RUN TIME

The Minimum Run Time influences the cycling rate and helps to evaporate condensation in heat exchangers.

Press the **NEXT** key to select **Option 07** and press the **Up** or **Down** key to set the Minimum Run Time.

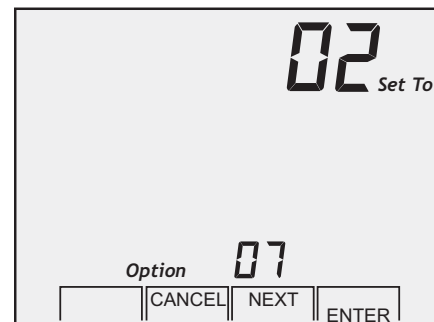

15 HEATING SETPOINT LIMIT

The maximum heating setpoint the user can set is 60 to 85F.

Press the **NEXT** key to select **Option 08** and press the **Up** or **Down** key to set maximum allowable heating setpoint.

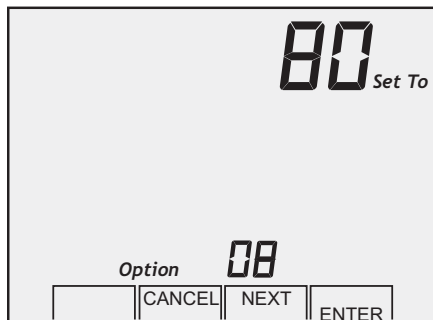

16 COOLING SETPOINT LIMIT

The minimum cooling setpoint the user can set is 55 to 80F.

Press the **NEXT** key to select **Option 09** and press the **Up** or **Down** key to set minimum allowable cooling setpoint.

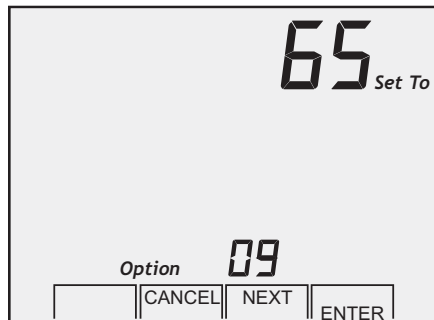

17 HEAT / COOL SETPOINT DIFFERENTIAL

The Heat/Cool temperature differential prevents the heating setpoint from being set above or too close to the cooling setpoint, resulting in inadvertent cycling between heating and cooling.

Press the **NEXT** key to select **Option 10** and press the **Up** or **Down** key to set the setpoint differential.

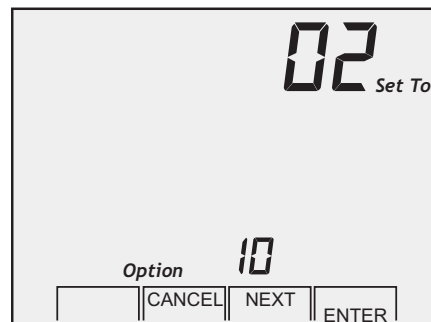

18 FIRST STAGE DIFFERENTIAL

First stage temperature differential determines the sensitivity of the thermostat. A lower differential will cause the thermostat to cycle more often with smaller temperature swings.

If the temperature differential between indoor temperature and setpoint temperature is greater than the first stage temperature differential, first stage heating or cooling will be activated.

Press the **NEXT** key to select **Option 11** and press the **Up** or **Down** key to set the first stage differential.

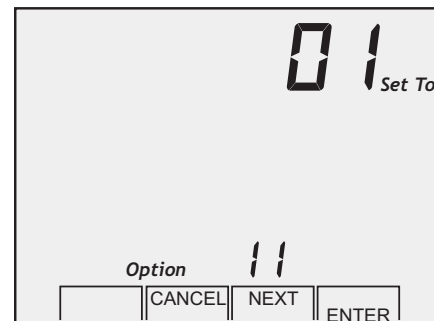

19 SECOND STAGE DIFFERENTIAL

Second stage temperature differential determines when the equipment advances from first to second stage. If the temperature differential between indoor temperature and setpoint exceeds the second stage temperature differential, the equipment activates second stage heating or cooling.

Press the **NEXT** key to select **Option 12** and the **Up** or **Down** key to set the second stage temperature differential. If the first stage temperature differential is greater than third stage temperature differential, first stage differential will automatically be incremented.

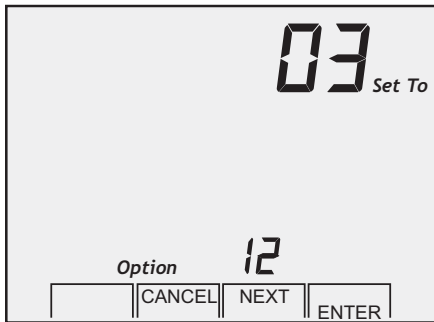

Note: Each stage differential is set at the desired number of degrees from the setpoint not the previous stage.

20 THIRD STAGE DIFFERENTIAL

Third stage temperature differential determines when the equipment advances from second to third stage. Setting the differential temperatures the same for second stage and third stage turns second and third stage on at the same time.

Press the **NEXT** key to select **Option 13** and the **Up** or **Down** key to set the third stage temperature differential. The third stage temperature differential cannot be set below the second stage differential.

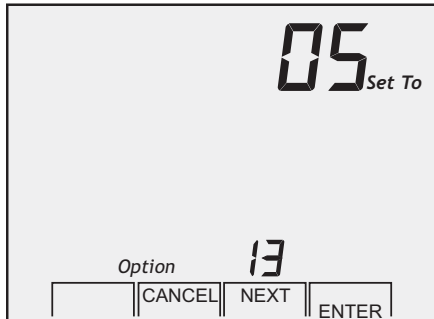

21 STAGE TIMING

The Staging Override Time will turn on the next stage even though the temperature differential has not been reached.

Press the **NEXT** key to select **Option 14** and the **Up** or **Down** key to set the stage timing.

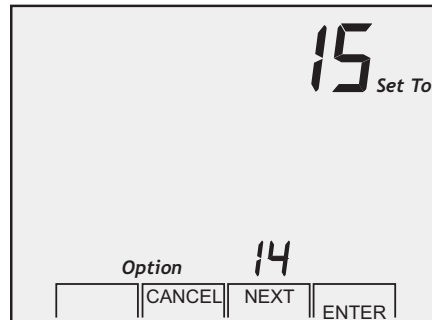

22 CALIBRATING THE TEMPERATURE SENSOR OFFSET

Typically, it is not necessary to adjust the temperature calibration offset from the factory setting. If calibration is necessary, a high quality electronic digital thermometer must be used. Place the thermometer sensor probe next to the thermostat sensor and allow five minutes before comparing the temperature readings.

Press and hold the **MENU** key until the calibration screen appears as shown. Use the **Up** and **Down** keys to adjust the temperature calibration offset. Press the **ENTER** key to save the setting and return to normal thermostat operation.

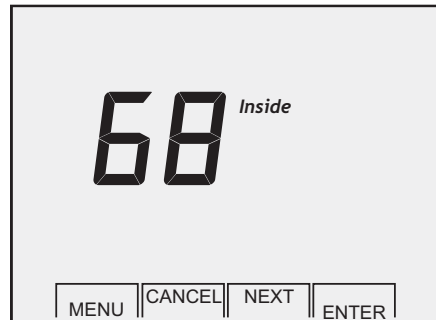

This installation manual should not be left with unauthorized users as it contains installer setup functions which, if not correctly set, may cause damage to the HVAC equipment or seriously affect performance.

This manual is to be used in conjunction with the supplied Owner's Manual.

Although great care has been taken in preparation of this manual, Research Products Corporation takes no responsibility for errors or omissions contained herein. It is the responsibility of the installer to ensure that this thermostat and the equipment connected to it operate in a safe and efficient manner.

Due to ongoing product improvements, Research Products Corporation reserves the right to change the specifications of the Model 8710 wireless thermostat or its components without notice.



P.O. Box 1467 • Madison, WI 53701-1467 • Phone: 800/334-6011 • Fax: 608/257-4357

www.aprilairepartners.com

61000828 10.11
B2205616A

© 2011 Aprilaire – A division of Research Products Corporation