

**Submittal Data: MULTI42HP230V1AO      42,000 BTU/H Wall Mounted Heat- Pump System**

**Job Name** \_\_\_\_\_ **Location** \_\_\_\_\_ **Date** \_\_\_\_\_

**Purchaser** \_\_\_\_\_ **Engineer** \_\_\_\_\_

**Submitted To** \_\_\_\_\_ **For**     Reference     Approval     Construction

**Unit Designation** \_\_\_\_\_ **Schedule No.** \_\_\_\_\_

- GENERAL FEATURES**
- Up To Five Indoor Units Comfort (5-Port)
  - G10 DC Inverter Technology
  - Quiet Operation - Both Indoor & Outdoor
  - Wireless Remote Controller
  - Optional Wired Remote Controller
  - Gold Fin Coil Coating
  - Intelligent Defrost
  - Auto Restart on Power Outages
  - Limited 7 yr Compressor & 5 yr Parts Warranty



**System Ratings**

<b>Cooling</b>	
Rated Capacity	40,000 BTU/H
Capacity Range	8,530-46,403 BTU/H
Power Input (Max)	4,400 W
SEER	16
EER	9.3

**Outdoor Unit Data**

<b>Compressor</b>	Type	DC Inverter Driven Rotary
	RLA	21.5 A
<b>Fan Motor</b>	Output Power	140 W
	FLA	1.1 A
	Air Flow (Max)	3,237 CFM
<b>Sound Pressure</b>		
	Cooling	58 db(A)
	Heating	58 db(A)
<b>Dimensions &amp; Weights</b>		
	Unit Dimensions (LxHxD)	42.8 x 43.4 x 17.3 -in
	Weight (Net/Shipping)	225/247 LBS
	Min. Number of Indoor Units	2
	Max. Number of Indoor Units	5

<b>Heating at 47° F</b>	
Rated Capacity	44,500 BTU/H
Capacity Range	10,662-47,768 BTU/H
Input Power (Max)	4,600 W
HSPF	8.2
COP	2.8





<b>Heating at 17° F</b>	
Rated Capacity	24,800 BTU/H
Capacity (Max)	34,570 BTU/H

<b>Operating Range</b>		
Cooling	(Max)	118°F (48 C)
	(Min)	23°F (-5 C)
Heating	(Max)	80°F (27 C)
	(Min)	5°F (-15 C)

<b>Power Supply</b>	
Normal Operational Voltage	208/230 V, 1 Phase, 60 Hz
Voltage Range	187 - 253 V
Main Power Wire Size	6-2 AWG
Interconnecting Cable Wire Size	14-4 AWG
MCA	29.0 A
MOCP/Breaker Size	50 A

**Refrigerant Piping Data**

Connection Method	Flared
Refrigerant Type	R410A
Factory Charge for Total Line Length	164-ft
Additional Charge Per Line Length	0.2-oz/ft
Total Refrigerant Pipe Length	262-ft
Max Refrigerant Piping Length to any Indoor Unit	82-ft
Min Refrigerant Piping Length to any Indoor Unit	10-ft
Max Elevation between Indoor Units	50-ft
Max Lift from Outdoor to Indoor Unit	82-ft
Max Drop from Outdoor to Indoor Unit	82-ft

Units: inch (mm)

**42,000 BTUH MODEL**

Model # MULTI42HP230V1AO 42,000 BTUH 230V

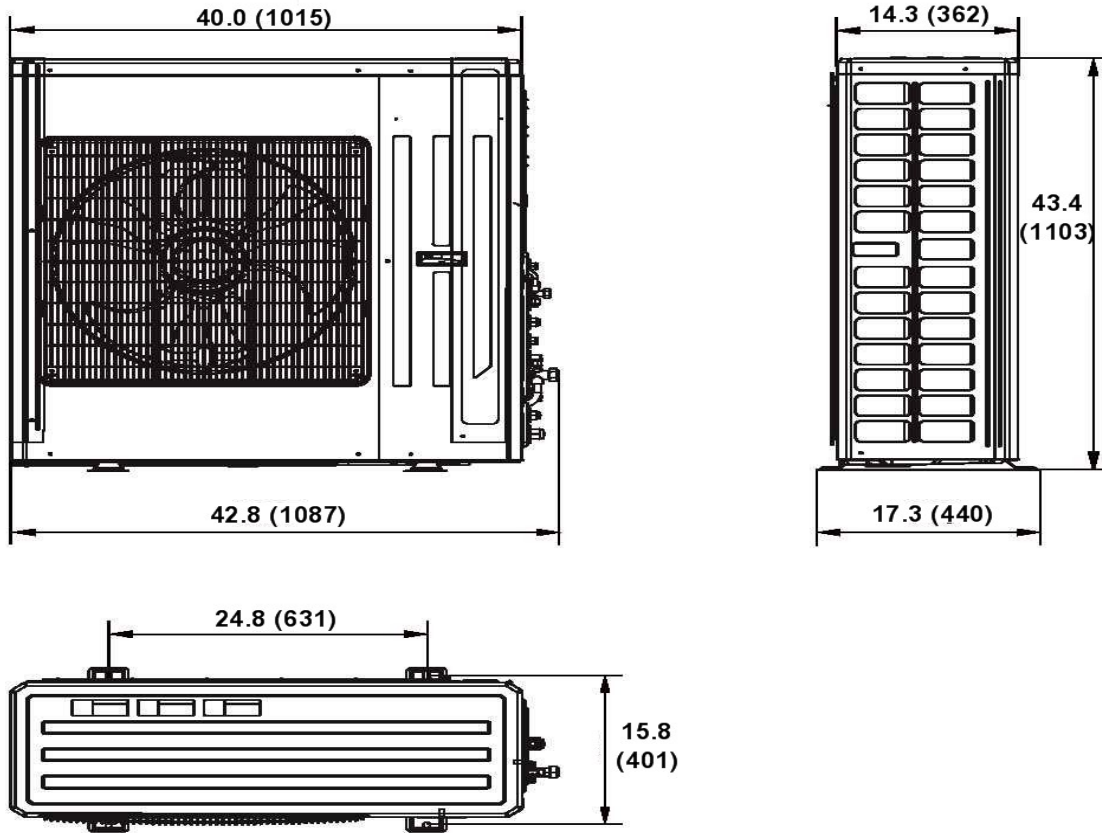

**Suction/Gas Line Port Size**

Port #1	3/8-in OD Flared
Port #2	3/8-in OD Flared
Port #3	1/2-in OD Flared
Port #4	1/2-in OD Flared
Port #5	5/8-in OD Flared

**Liquid Line Port Size**

Port #1	1/4-in OD Flared
Port #2	1/4-in OD Flared
Port #3	1/4-in OD Flared
Port #4	1/4-in OD Flared
Port #5	3/8-in OD Flared

**MINIMUM SPACING REQUIREMENTS**

Units: inch (mm)

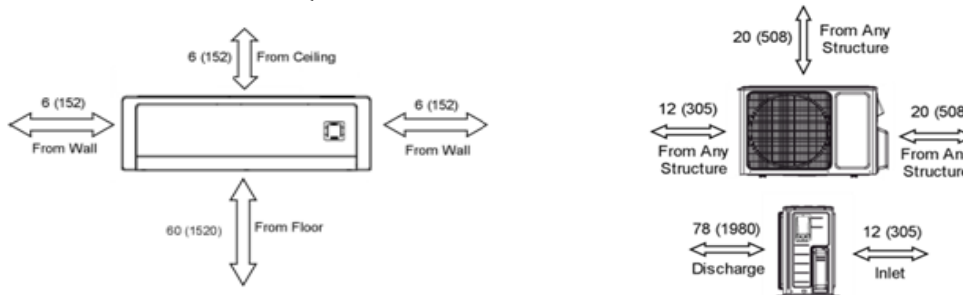

**Notes:**

1. Recommended Interconnecting Cable Type Stranded Bare Copper Conductors THHN 600V Unshielded Wire
2. Power wiring cable size must comply with applicable national and local codes.
3. Test conditions are based on AHRI 210/240.



Specifications are subject to change without notice. Manufacturer reserves the right to discontinue or modify specifications or designs without notice or without incurring obligations. All rights reserved.

Units: inch (mm)

**9,000 AND 12,000 BTUH MODELS**

Model # NEO09HP230VAA-H or GWH09MB-D3DNA3D/I 9,000 BTUH 230V

Model # NEO12HP230VAA-H or GWH12MB-D3DNA3D/I 12,000 BTUH 230V

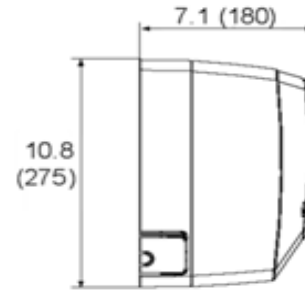
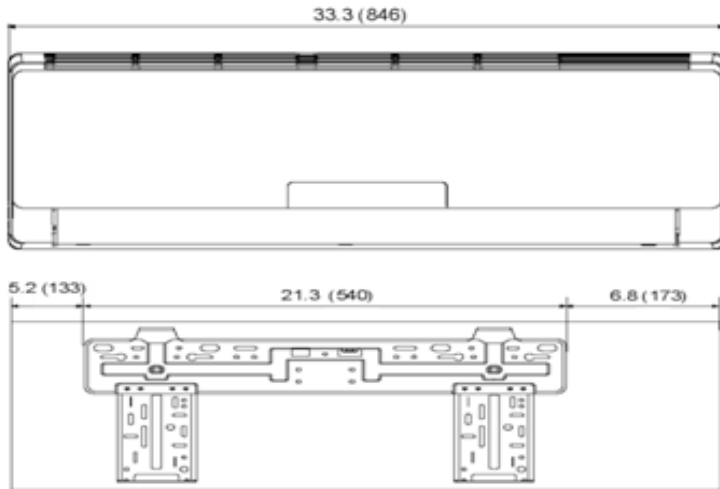

Liquid Line Valve	1/4-in OD Flared
Suction/Gas Line Valve	3/8-in OD Flared
Drain Connector	5/8-in OD

*Note: Size Refrigerant lines based on evaporator port sizes.*

Indoor Capacity Size	Fan (watts)	CFM (High)	Sound Power (Low/High)**
9,000 BTUH	20	330	26/41
12,000 BTUH	20	341	28/42

Units: inch (mm)

**18,000 BTUH MODEL**

Model # NEO18HP230VAA-H or GWH18MC-D3DNA3D/I 18,000 BTUH 230V

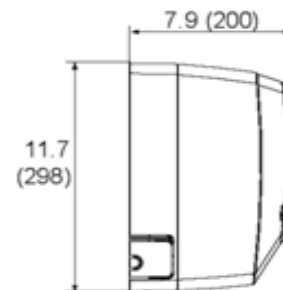
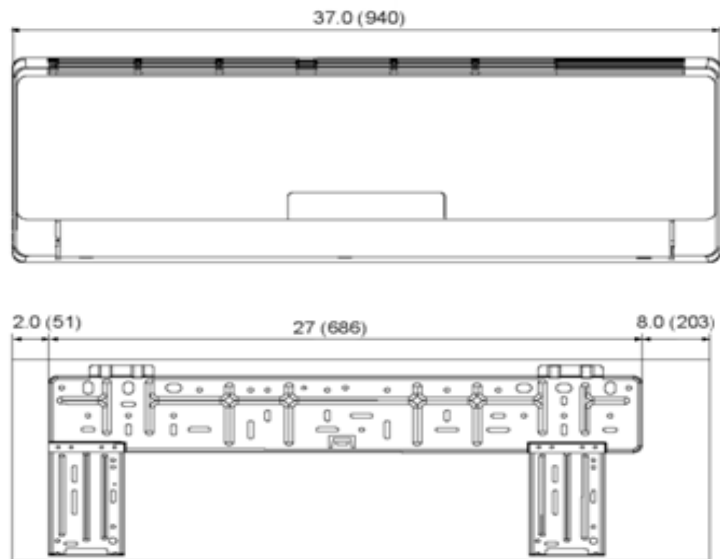

Liquid Line Valve	1/4-in OD Flared
Suction/Gas Line Valve	1/2-in OD Flared
Drain Connector	5/8-in OD

*Note: Size Refrigerant lines based on evaporator port sizes.*

Indoor Capacity Size	Fan (watts)	CFM (High)	Sound Power (Low/High)**
18,000 BTUH	20	500	35/46



\*\*Sound Power ratings are per AHRI 270 and AHRI 350

Specifications are subject to change without notice. Manufacturer reserves the right to discontinue or modify specifications or designs without notice or without incurring obligations. All rights reserved.

Units: inch (mm)

**9,000 AND 12,000 BTUH MODELS**

Model # GWH09AB-D3DNA2D/I 9,000 BTUH 230V  
 Model # GWH12AB-D3DNA2D/I 12,000 BTUH 230V

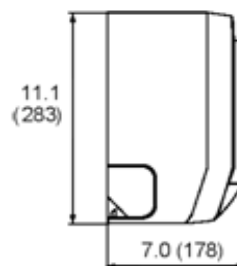
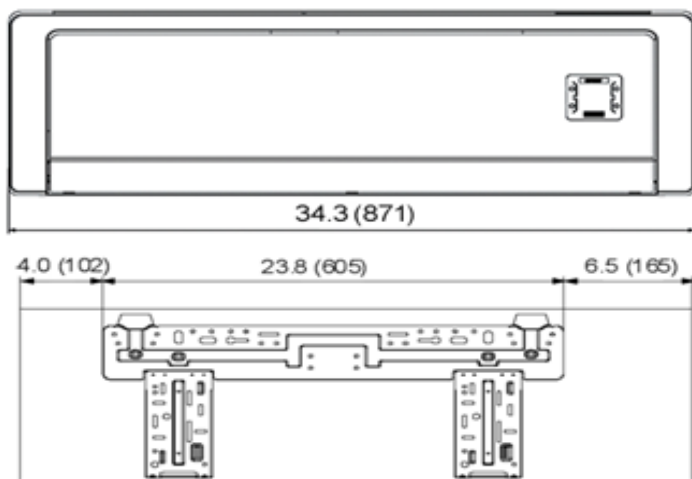

Liquid Line Valve	1/4-in OD Flared
Suction/Gas Line Valve	1/2-in OD Flared
Drain Connector	5/8-in OD

*Note: Size Refrigerant lines based on evaporator port sizes.*

Indoor Capacity Size	Fan (watts)	CFM (High)	Sound Power (Low/High)**
9,000 BTUH	10	341	28/46
12,000 BTUH	10	353	28/46

Units: inch (mm)

**18,000 BTUH MODEL**

Model # GWH18AC-D3DNA2D/I 18,000 BTUH 230V

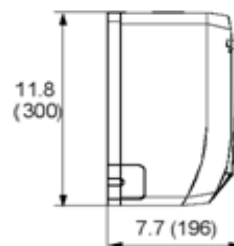
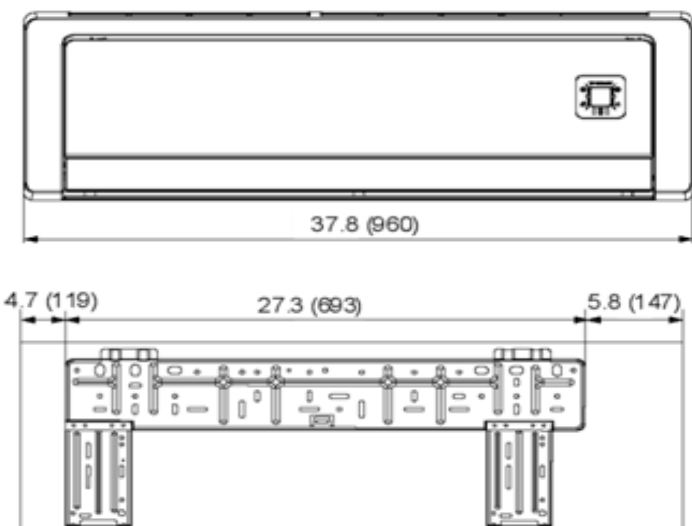

Liquid Line Valve	1/4-in OD Flared
Suction/Gas Line Valve	1/2-in OD Flared
Drain Connector	5/8-in OD

*Note: Size Refrigerant lines based on evaporator port sizes.*

Indoor Capacity Size	Fan (watts)	CFM (High)	Sound Power (Low/High)**
18,000 BTUH	20	488	35/46



\*\*Sound Power ratings are per AHRI 270 and AHRI 350

Specifications are subject to change without notice. Manufacturer reserves the right to discontinue or modify specifications or designs without notice or without incurring obligations. All rights reserved.

**COOLING CAPACITY (BTUH)**

Indoor Combinations	Indoor Unit A	Indoor Unit B	Indoor Unit C	Indoor Unit D	Indoor Unit E
9K + 9K + 9K	8,189	8,189	8,189		
9K + 9K + 12K	6,995	7,336	10,236		
9K + 9K + 18K	8,018	8,018	16,378		
9K + 12K + 12K	8,530	10,577	10,577		
9K + 12K + 18K	8,530	10,918	16,036		
9K + 18K + 18K	7,165	15,013	15,013		
12K + 12K + 12K	11,771	11,771	11,942		
12K + 12K + 18K	10,918	10,918	13,648		
12K + 18K + 18K	9,554	15,013	15,013		
18K + 18K + 18K	13,136	13,136	13,307		
9K + 9K + 9K + 9K	8,871	8,871	8,871	8,871	
9K + 9K + 9K + 12K	8,189	8,189	8,189	10,918	
9K + 9K + 9K + 18K	7,848	7,848	7,848	16,036	
9K + 9K + 12K + 12K	7,165	7,165	10,577	10,577	
9K + 9K + 12K + 18K	6,824	6,824	10,577	15,354	
9K + 9K + 18K + 18K	6,483	6,483	13,307	13,307	
9K + 9K + 12K + 12K	7,848	10,577	10,577	10,577	
9K + 12K + 12K + 18K	7,165	8,701	8,701	15,013	
12K + 12K + 12K + 12K	9,895	9,895	9,895	9,895	
12K + 12K + 12K + 18K	8,359	8,359	8,359	14,501	
12K + 12K + 18K + 18K	7,848	7,848	11,942	11,942	
9K + 9K + 9K + 9K + 9K	7,916	7,916	7,916	7,916	7,916
9K + 9K + 9K + 9K + 12K	7,421	7,421	7,421	7,421	9,895
9K + 9K + 9K + 9K + 18K	6,824	6,824	6,824	6,824	12,283
9K + 9K + 9K + 12K + 12K	7,165	7,165	7,165	9,042	9,042
9K + 9K + 9K + 12K + 18K	6,483	6,483	6,483	8,274	11,857
9K + 9K + 9K + 18K + 18K	6,483	6,483	6,483	10,065	10,065
9K + 9K + 12K + 12K + 12K	6,483	6,483	8,871	8,871	8,871
9K + 9K + 12K + 12K + 18K	5,971	5,971	8,018	8,018	11,601
9K + 12K + 12K + 12K + 12K	6,483	8,274	8,274	8,274	8,274
12K + 12K + 12K + 12K + 12K	7,916	7,916	7,916	7,916	7,916

Capacity data is based on the following conditions :

Cooling Nominal Test Conditions

Indoor: 80°F DB/67°F WB

Outdoor: 95°F DB/75°F WB

Heating Nominal Test Conditions

Indoor: 70°F DB/60°F WB

Outdoor: 47°F DB/43°F W



[www.greecomfort.com](http://www.greecomfort.com)

Specifications are subject to change without notice. Manufacturer reserves the right to discontinue or modify specifications or designs without notice or without incurring obligations. All rights reserved.

COOLING CAPACITY (BTUH)

Indoor Units Combinations	Rated System Capacity (BtuH)	Capacity Rating (Min.~Max.) (1) (BtuH)	Indoor Unit A (BtuH)	Indoor Unit B (BtuH)	Indoor Unit C (BtuH)	Indoor Unit D (BtuH)	Indoor Unit E (BtuH)
9K+9K	20,472	11,942~30,709	8,530	8,530			
9K+12K	20,472	11,942~30,709	8,530	11,942			
9K+18K	24,226	11,942~30,709	7,506	16,719			
9K+24K (2)	27,297	11,942~30,709	6,824	20,472			
12K+12K	20,472	11,942~27,297	10,236	10,236			
12K+18K	27,297	11,942~30,709	10,577	16,719			
12K+24K (2)	32,415	11,942~37,533	10,236	22,178			
18K+18K	32,415	11,942~37,533	16,207	16,207			
18K+24K (2)	32,415	11,942~37,533	13,989	18,766			
24K +24K (2)	32,415	11,942~37,533	16,207	16,207			
9K+9K+9K	24,567	11,942~30,709	8,189	8,189	8,189		
9K+9K+12K	24,567	11,942~30,709	6,994	7,336	10,236		
9K+9K+18K	32,415	11,942~37,533	8,018	8,018	16,378		
9K+9K+24K (2)	35,486	11,942~41,628	8,189	8,189	19,107		
9K+12K+12K	29,685	11,942~32,756	8,530	10,577	10,577		
9K+12K+18K	35,486	11,942~41,628	8,530	10,918	16,037		
9K+12K+24K (2)	39,580	11,942~46,405	7,847	9,553	22,178		
9K+18K+18K	39,580	11,942~46,405	7,165	15,013	15,013		
9K+18K+24K (2)	39,580	11,942~46,405	6,824	13,648	19,107		
9K+24K+24K (2)	39,580	11,942~46,405	5,800	16,890	16,890		
12K+12K+12K	35,486	11,942~41,628	11,771	11,771	11,942		
12K+12K+18K	35,486	11,942~41,628	10,918	10,918	13,648		
12K+12K+24K (2)	39,580	11,942~46,405	10,065	10,065	19,449		
12K+18K+18K	39,580	11,942~46,405	9,553	15,013	15,013		
12K+18K+24K (2)	39,580	11,942~46,405	9,042	14,160	16,378		
12K+24K+24K (2)	39,580	11,942~46,405	8,530	15,525	15,525		
18K+18K+18K	39,580	11,942~46,405	13,136	13,136	13,307		
18K+18K+24K (2)	39,580	11,942~46,405	12,283	12,283	15,013		
9K+9K+9K+9K	35,486	<b>11,942~41,628</b>	8,871	8,871	8,871	8,871	
9K+9K+9K+12K	35,486	11,942~41,628	8,189	8,189	8,189	10,918	
9K+9K+9K+18K	39,580	11,942~46,405	7,847	7,847	7,847	16,037	
9K+9K+9K+24K (2)	39,580	11,942~46,405	6,824	6,824	6,824	19,107	
9K+9K+12K+12K	35,486	11,942~41,628	7,165	7,165	10,577	10,577	
9K+9K+12K+18K	39,580	11,942~46,405	6,824	6,824	10,577	15,354	
9K+9K+12K+24K (2)	39,580	11,942~46,405	6,312	6,312	9,553	17,572	
9K+9K+18K+18K	39,580	11,942~46,405	6,483	6,483	13,307	13,307	
9K+9K+18K+24K (2)	39,580	11,942~46,405	6,141	6,141	10,407	16,890	
9K+12K+12K+12K	39,580	11,942~46,405	7,847	10,577	10,577	10,577	
9K+12K+12K+18K	39,580	11,942~46,405	7,165	8,700	8,700	15,013	
9K+12K+12K+24K (2)	39,580	11,942~46,405	6,483	7,933	7,933	17,231	
9K+12K+18K+18K	39,580	11,942~46,405	6,483	8,189	12,454	12,454	
9K+18K+18K+18K	39,580	11,942~46,405	5,800	11,260	11,260	11,260	
12K+12K+12K+12K	39,580	11,942~46,405	9,895	9,895	9,895	9,895	
12K+12K+12K+18K	39,580	11,942~46,405	8,359	8,359	8,359	14,501	
12K+12K+12K+24K (2)	39,580	11,942~46,405	7,506	7,506	7,506	17,060	
12K+12K+18K+18K	39,580	11,942~46,405	7,847	7,847	11,942	11,942	
9K+9K+9K+9K+9K	39,580	11,942~46,405	7,916	7,916	7,916	7,916	7,916
9K+9K+9K+9K+12K	39,580	11,942~46,405	7,421	7,421	7,421	7,421	9,895
9K+9K+9K+9K+18K	39,580	11,942~46,405	6,824	6,824	6,824	6,824	12,283
9K+9K+9K+9K+24K (2)	39,580	11,942~46,405	6,483	6,483	6,483	6,483	13,648
9K+9K+9K+12K+12K	39,580	11,942~46,405	7,165	7,165	7,165	9,042	9,042
9K+9K+9K+12K+18K	39,580	11,942~46,405	6,483	6,483	6,483	8,274	11,857
9K+9K+9K+18K+18K	39,580	11,942~46,405	6,483	6,483	6,483	10,065	10,065
9K+9K+12K+12K+12K	39,580	11,942~46,405	6,483	6,483	8,871	8,871	8,871
9K+9K+12K+12K+18K	39,580	11,942~46,405	5,971	5,971	8,018	8,018	11,601
9K+12K+12K+12K+12K	39,580	11,942~46,405	6,483	8,274	8,274	8,274	8,274
9K+12K+12K+12K+18K	39,580	11,942~46,405	6,141	7,592	7,592	7,592	10,662
12K+12K+12K+12K+12K	39,580	11,942~46,405	7,916	7,916	7,916	7,916	7,916

Note:

1) It is critical to size the outdoor unit for the entire building load and each indoor unit for its individual zone load.

2) 24K size is reserved for Ceiling Cassettes, Concealed Ducts, and Floor/Ceilings units only. Not Wall Mount units.

Cooling Nominal Test Conditions: Indoor: 80°F DB/67°F WB Outdoor: 95°F DB/75°F WB

Specifications are subject to change without notice. Manufacturer reserves the right to discontinue or modify specifications or designs

without notice or without incurring obligations. All rights reserved.

HEATING CAPACITY (BTUH)

Indoor Units Combinations	Rated System Capacity (BtuH)	Capacity Rating (Min.~Max.) (1) (BtuH)	Indoor Unit A (BtuH)	Indoor Unit B (BtuH)	Indoor Unit C (BtuH)	Indoor Unit D (BtuH)	Indoor Unit E (BtuH)
9K+9K	25,591	15,354~33,780	10,662	14,928			
9K+12K	25,591	15,354~33,780	10,662	14,928			
9K+18K	30,282	15,354~33,780	9,383	20,899			
9K+24K (2)	34,121	15,354~33,533	8,530	25,591			
12K+12K	25,591	15,354~30,026	12,795	12,795			
12K+18K	34,121	15,354~37,533	13,222	20,899			
12K+24K (2)	40,519	15,354~42,651	12,795	27,723			
18K+18K	40,519	15,354~42,651	20,261	20,261			
18K+24K (2)	40,519	15,354~42,651	17,487	23,458			
24K+24K (2)	40,519	15,354~42,651	20,261	20,261			
9K+9K+9K	30,709	15,354~40,945	10,236	10,236	10,236		
9K+9K+12K	30,709	15,354~40,945	8,745	9,171	12,795		
9K+9K+18K	40,519	15,354~42,651	10,024	10,024	20,472		
9K+9K+24K (2)	44,357	15,354~45,040	10,236	10,236	23,884		
9K+12K+12K	37,107	15,354~40,945	10,662	13,222	13,222		
9K+12K+18K	44,357	15,354~45,040	10,662	13,648	20,046		
9K+12K+24K (2)	45,040	15,354~47,769	8,929	10,871	25,239		
9K+18K+18K	45,040	15,354~47,769	8,155	17,084	17,084		
9K+18K+24K (2)	45,040	15,354~47,769	7,766	15,532	21,742		
9K+24K+24K (2)	45,040	15,354~47,769	6,599	19,220	19,220		
12K+12K+12K	44,357	15,354~45,040	14,716	14,716	14,928		
12K+12K+18K	44,357	15,354~45,040	13,648	13,648	17,060		
12K+12K+24K (2)	45,040	15,354~47,769	11,454	11,454	22,131		
12K+18K+18K	45,040	15,354~47,769	10,871	17,084	17,084		
12K+18K+24K (2)	45,040	15,354~47,769	10,291	16,112	18,637		
12K+24K+24K (2)	45,040	15,354~47,769	9,707	17,668	17,668		
18K+18K+18K	45,040	15,354~47,769	14,948	14,948	15,143		
18K+18K+24K (2)	45,040	15,354~47,769	13,979	13,979	17,084		
9K+9K+9K+9K	44,357	<b>15,354~47,769</b>	11,089	11,089	11,089	11,089	
9K+9K+9K+12K	44,357	15,354~47,769	10,236	10,236	10,236	13,648	
9K+9K+9K+18K	45,040	15,354~47,769	8,929	8,929	8,929	18,248	
9K+9K+9K+24K (2)	45,040	15,354~47,769	7,766	7,766	7,766	21,742	
9K+9K+12K+12K	44,357	15,354~47,769	8,956	8,956	13,222	13,222	
9K+9K+12K+18K	45,040	15,354~47,769	7,766	7,766	12,038	17,473	
9K+9K+12K+24K (2)	45,040	15,354~47,769	7,182	7,182	10,871	19,995	
9K+9K+18K+18K	45,040	15,354~47,769	7,377	7,377	15,143	15,143	
9K+9K+18K+24K (2)	45,040	15,354~47,769	6,988	6,988	11,843	19,220	
9K+12K+12K+12K	45,040	15,354~47,769	8,929	12,038	12,038	12,038	
9K+12K+12K+18K	45,040	15,354~47,769	8,155	9,902	9,902	17,084	
9K+12K+12K+24K (2)	45,040	15,354~47,769	7,377	9,028	9,028	19,609	
9K+12K+18K+18K	45,040	15,354~47,769	7,377	9,318	14,170	14,170	
9K+18K+18K+18K	45,040	15,354~47,769	6,599	12,812	12,812	12,812	
12K+12K+12K+12K	45,040	15,354~47,769	11,260	11,260	11,260	11,260	
12K+12K+12K+18K	45,040	15,354~47,769	9,513	9,513	9,513	16,501	
12K+12K+12K+24K (2)	45,040	15,354~47,769	8,540	8,540	8,540	19,415	
12K+12K+18K+18K	45,040	15,354~47,769	8,929	8,929	13,590	13,590	
9K+9K+9K+9K+9K	45,040	15,354~47,769	9,008	9,008	9,008	9,008	9,008
9K+9K+9K+9K+12K	45,040	15,354~47,769	8,445	8,445	8,445	8,445	11,260
9K+9K+9K+9K+18K	45,040	15,354~47,769	7,766	7,766	7,766	7,766	13,979
9K+9K+9K+9K+24K (2)	45,040	15,354~47,769	7,377	7,377	7,377	7,377	15,532
9K+9K+9K+12K+12K	45,040	15,354~47,769	8,155	8,155	8,155	10,291	10,291
9K+9K+9K+12K+18K	45,040	15,354~47,769	7,377	7,377	7,377	9,414	13,491
9K+9K+9K+18K+18K	45,040	15,354~47,769	7,377	7,377	7,377	11,454	11,454
9K+9K+12K+12K+12K	45,040	15,354~47,769	7,377	7,377	10,096	10,096	10,096
9K+9K+12K+12K+18K	45,040	15,354~47,769	6,793	6,793	9,124	9,124	13,201
9K+12K+12K+12K+12K	45,040	15,354~47,769	7,377	9,414	9,414	9,414	9,414
9K+12K+12K+12K+18K	45,040	15,354~47,769	6,988	8,639	8,639	8,639	12,133
12K+12K+12K+12K+12K	45,040	15,354~47,769	9,008	9,008	9,008	9,008	9,008

Note:

- 1) It is critical to size the outdoor unit for the entire building load and each indoor unit for its individual zone load.
- 2) 24K size is reserved for Ceiling Cassettes, Concealed Ducts, and Floor/Ceilings units only. Not Wall Mount units.

Heating Nominal Test Conditions: Indoor: 70°F DB/60°F WB Outdoor: 47°F DB/43°F W

Specifications are subject to change without notice. Manufacturer reserves the right to discontinue or modify specifications or designs without notice or without incurring obligations. All rights reserved.

## COOLING PERFORMANCE

Outdoor Ambient Temperature (DB)	Indoor Entering Air Temperatures (DB) 50% RH					
	62 F		67 F		72 F	
	TC	SHC	TC	SHC	TC	SHC
25 F	49,212	36,540	53,192	38,511	56,860	40,939
35 F	48,092	36,497	51,216	37,388	53,704	38,828
45 F	45,716	35,110	48,888	36,275	52,380	37,976
55 F	44,012	34,065	46,932	35,199	50,312	36,728
65 F	42,512	33,032	46,776	35,503	49,600	36,258
75 F	40,840	31,937	44,000	33,836	47,324	34,925
85 F	39,200	31,125	42,000	32,424	45,600	34,063
95 F	37,200	29,723	40,000	31,960	43,760	32,864
105 F	35,200	28,582	37,912	30,254	41,200	31,642
115 F	33,200	27,357	35,200	28,512	37,600	29,441

## HEATING PERFORMANCE

Outdoor Ambient Temperature (DB) (80% RH)	Indoor Entering Air Temperatures (DB)					
	65 F		70 F		75 F	
	TC	SHC	TC	SHC	TC	SHC
5 F	34,729	34,729	32,776	32,776	31,973	31,973
15 F	37,122	37,122	33,867	33,867	33,664	33,664
25 F	39,388	39,388	37,384	37,384	35,257	35,257
35 F	41,586	41,586	38,491	38,491	36,876	36,876
45 F	43,759	43,759	42,275	42,275	39,713	39,713
55 F	43,818	43,818	42,275	42,275	40,690	40,690
65 F	43,611	43,611	42,973	42,973	41,649	41,649

TC- Total Capacity ( BtuH)

SHC- Sensible Capacity (BtuH)