



Free Match Series R410A GMV Multi VRF Duct Type Indoor Unit (For North America)

Owner's Manual

Commercial Air Conditioners



Thank you for choosing Commercial Air Conditioners, please read this owner's manual carefully before operation and retain it for future reference.

User Notice

◆ The total capacity of the indoor units which runs at the same time can not exceed 150% of that of the outdoor units; otherwise, the cooling (heating) effect of each indoor unit would be poor.

◆ Switch the main power on 8 hours before start the unit, helpful for a successful startup.

◆ It is a normal phenomenon that the indoor unit fan will still run for 20~70 seconds after the indoor unit receives the "stop" signal so as to make full use of after-heat for the next operation.

◆ When the running modes of the indoor and outdoor units conflict, it will be indicated on the display of the wired controller in five seconds and then the indoor unit will stop. In this case, they can back to the normal condition by harmonizing their running modes: The HEAT mode conflicts with each of the COOL mode, DRY mode and FAN mode, while the COOL mode, DRY mode and FAN mode are compatible between each other. If the supply power fails when the unit is running, then the indoor unit will send the "start" signal to the outdoor unit three minutes later after power recovery.

◆ During installation, the communication cable and the power cord must not be twisted together but instead separated with an interval of at least 2cm, otherwise the unit is likely to run abnormally.

◆ This appliance is not intended for use by persons (including children) with reduced physical, sensory or mental capabilities, or lack of experience and knowledge, unless they have been given supervision or instruction concerning use of the appliance by a person responsible for their safety. Children should be supervised to ensure that they do not play with the appliance.



This product must not be disposed together with the domestic waste. This product has to be disposed at an authorized place for recycling of electrical and electronic appliances.

Thank you for selecting Gree air conditioner. Before use, please read this manual carefully and keep it properly for further reference.

Contents

1 Safety Precautions	1
2 Installation Location and Matters Needing Attention	2
2.1 How to select the Installation Location for the indoor unit.....	2
2.2 Electric Wiring	2
2.3 Earthing Requirements	2
2.4 Accessories for Installation	3
3 Installation Instructions	4
3.1 Outline Dimension Drawings of the Indoor Unit	4
3.2 Dimension Requirements on the Installation Space of the Indoor Unit.....	4
3.3 Installation of the Indoor Unit	5
3.4 Horizontality Check of the Indoor Unit	6
3.5 Installation of the Air Supply Duct	6
3.6 Drawings of the Air Supply Outlet and Return Air Inlet	7
3.7 Installation of the Return Air Duct	8
3.8 Installation of the Condensate Pipe	9
3.9 Design of the Drain Pipe	9
3.10 Installation of the Drain Pipe	10
3.11 Precautions for the Lift Pipe	11
3.12 Test for the Drainage System.....	11
3.13 Piping	12
3.14 Insulation for the Refrigerant Pipe	12
3.15 Wiring between the Wire and the Wiring Terminal	13
3.16 Wiring of the Power Cord (single-phase).....	14
3.17 Wiring of the Signal Line of the Wired Controller	16
3.18 Electric Installation	16
4 Rated Working Conditions.....	17
5 Error Analysis	18
6 Maintenance.....	19

1 Safety Precautions

Please read this manual carefully before using and operating correctly as instructed in this manual.

Please take special attention to the meaning of these two marks:

 **Warning!** It indicates improper operation which will lead to human casualty or severe injury.

 **Note!** It indicates improper operation which will lead to injury or property damage.

 **Warning:**

◆ The installation should be committed to the appointed service center; otherwise it will cause water leakage, electric shock or fire etc..

◆ Please install the unit at a place where is strong enough to withstand the weight of the unit; otherwise, the unit would fall down and cause injury or death.

◆ The drain pipe should be installed as instructed in the manual to guarantee the proper drainage; meanwhile it should be insulated to prevent condensing; otherwise the improper installation would cause water leakage and then wet the household wares in the room.

◆ Do not use or place any inflammable, combustible or any noxious substance next to the unit.

◆ Under the occurrence of an error (like burning smell etc.), please cut off the main power supply of the unit.

◆ Keep good ventilation in the room to avoid oxygen deficit.

◆ Never insert your finger or any other object into the air outlet/inlet grille.

◆ Please take notice of the supporting frame of the unit to see if it is damaged over the long time period of use.

◆ Never refit the unit and contact the sales agent or the professional installation personnel for the repair or relocation of the unit.

An all-pole disconnection switch having a contact separation of at least 3mm in all poles should be connected in fixed wiring.

 **Caution!**

◆ Before installation, please check if the power supply corresponds with the requirement specified on the nameplate and also check its security.

◆ Before using the unit, please check if the piping and wiring are correct to avoid water leakage, refrigerant leakage, electric shock, or fire etc.

◆ The main power supply must be earthed to avoid the hazard of electric shock and never connect this earth wire to the gas pipe, running water pipe, lightning rod or phone cable's earth lead.

◆ Turn off the unit after it runs at least five minutes; otherwise its service life will be shortened.

◆ Do not allow children operate this unit.

◆ Do not operate this unit with wet hands.

◆ Cut off the main power supply prior to the cleaning of the unit or the replacement of the air filter.

◆ When the unit is not to be used for a long time, please cut off the main power supply of the unit.

◆ Do not expose the unit to the moist or corrosive circumstances.

◆ After the electric installation, please take an electric leakage test.

2 Installation Location and Matters Needing Attention

The installation of the unit must comply with the national and local safety regulations. The installation quality directly affects the normal use, so the user should not carry out the installation personally, instead, the installation and debugging should be done by technician according to this manual. Only after that, can the unit be energized.

2.1 How to select the Installation Location for the indoor unit

- (1). Where there is no direct sunlight.
- (2). Where the top hanger, ceiling and the building structure are strong enough to withstand the weight of the unit.
- (3). Where the drain pipe can be easily connected to outside.
- (4). Where the flow of the air inlet and outlet are not blocked.
- (5). Where the refrigerant pipe of the indoor unit can be easily led to outside.
- (6). Where there is no inflammable, explosive substances or their leakage.
- (7). Where there is no corrosive gas, heavy dust, salt mist, smog or moisture.

CAUTION!

The unit which is installed in the following places is likely to run abnormally. If unavoidable, please contact the technician at the GREE appointed service center:

- ① Where is full of oil;
- ② Alkaline soil off the sea;
- ③ Where there is sulfur gas(like sulfur hot spring);
- ④ Where there are devices with high frequency (like wireless devices, electric welding devices, or medical equipments);
- ⑤ Special circumstances.

2.2 Electric Wiring

- (1). The installation must be done in accordance with the national wiring regulations.
- (2). Only the power cord with the rated voltage and exclusive circuit for the air conditioning can be used.
- (3). Do not pull the power cord by force.
- (4). The electric installation should be carried out by the technician as instructed by the local laws, regulations and also this manual.
- (5). The diameter of the power cord should be large enough and once it is damaged it must be replaced by the dedicated one.
- (6). The earthing should be reliable and the earth wire should be connected to the dedicated device of the building by the technician. Besides, the air switch coupled with the leakage current protection switch must be equipped, which is of enough capacity and of both magnetic and thermal tripping functions in case of the short circuit and overload.

2.3 Earthing Requirements

- (1). The air conditioner is classified into the Class I appliances, so its earthing must be reliable.
- (2). The yellow-green line of the air conditioner is the earth line and can not be used for other

purpose, cut off or fixed by the tapping screw; otherwise it would cause the hazard of electric shock.

(3). The reliable earth terminal should be provided and the earth wire can not be connected to any of the following places:

- ① . Running water pipe;
- ② . Coal gas pipe;
- ③ . Sewage pipe;
- ④ . Other places where the technician think unreliable.

2.4 Accessories for Installation

Refer to the packing list for the accessories of the indoor and outdoor units respectively.

3 Installation Instructions

3.1 Outline Dimension Drawings of the Indoor Unit

Note: the unit in the followings figures is mm, unless otherwise specified.

Fig.1 is applicable to GFH(09)EA-D3DNA1A/I,GFH(12)EA-D3DNA1A/I,GFH(18)EA-D3DNA1A/I, GFH(21)EA-D3DNA1A/I, GFH(24)EA-D3DNA1A/I:

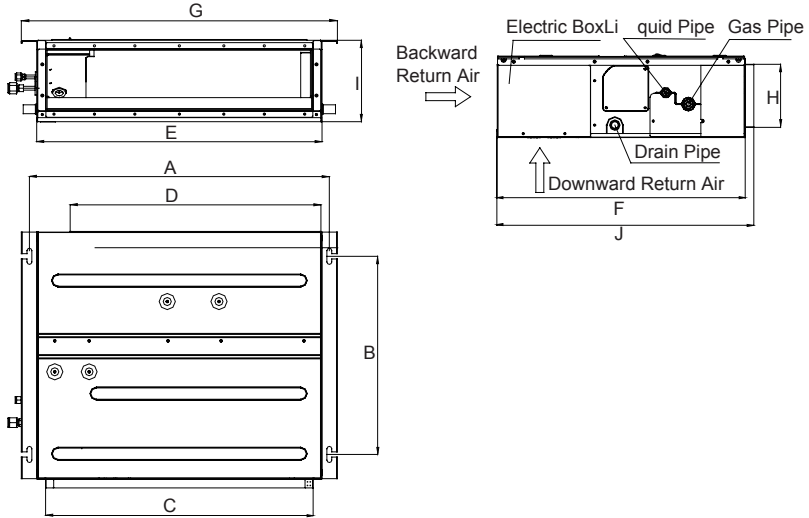

Fig.1

Table 1: Outline Dimensions

Model \ Item	A	B	C	D	E	F	G	H	I	J
GFH(09)EA-D3DNA1A/I	742	491	662	620	700	615	782	156	200	635
GFH(12)EA-D3DNA1A/I										
GFH(18)EA-D3DNA1A/I	942	491	862	820	900	615	982	156	200	635
GFH(21)EA-D3DNA1A/I	1142	491	1062	1020	1100	615	1182	156	200	635
GFH(24)EA-D3DNA1A/I										

3.2 Dimension Requirements on the Installation Space of the Indoor Unit

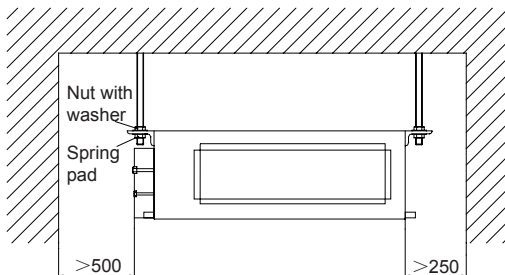

Fig. 2

3.3 Installation of the Indoor Unit

(1). Requirements on the Installation Location

- 1) Ensure the hanger is strong enough to withstand the weight of the unit.
- 2) The drainage pipe is easy for connection.
- 3) No obstacle is in the inlet/outlet and the air circulation is in good condition.
- 4) Ensure the installation space shown in Fig.2 is left for the access to maintenance.
- 5) It should be far away from where there is heat source, leakage of inflammable, explosive substances, or smog.

6) It is the ceiling type unit (concealed in the ceiling).

7) The power cords and connection lines of the indoor and outdoor units must be at least 1m away from the TV set or radio to avoid the image interference and noise (even if 1m is kept, the noise may be produced due to the strong electromagnetic wave).

(2). Installation of the Indoor Unit

Insert the M10 expansion bolt into the hole, and then knock the nail into the bolt. Refer to the Outline Dimension Drawings of the Indoor Unit for the distance between holes and see Fig.3 for the installation of the expansion bolt.

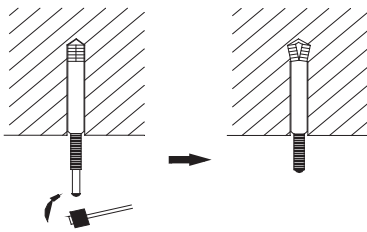

Fig.3

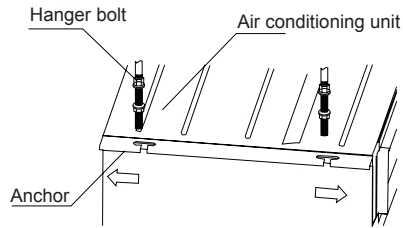

Fig.4

Install the hanger on the indoor unit, as shown in Fig.4.

Install the indoor unit on the ceiling, as shown in Fig.5.

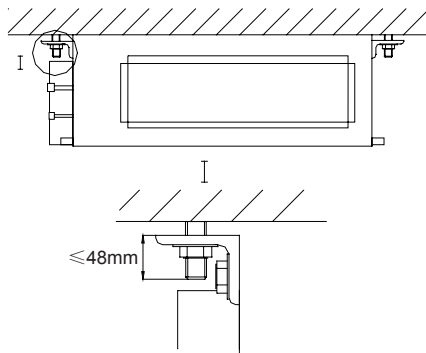

Fig.5

CAUTION!

①. Prior to the installation, please make a good preparation for all piping (refrigerant pipe, drain pipe) and wiring (wires of the wired controller, wires between the indoor and outdoor unit) of the indoor unit to make the further installation much easier.

- ② . If there is an opening in the ceiling, it is better to reinforce it to keep it flat and prevent it vibrating. Consult the user and builder for more details.
- ③ . If the strength of the ceiling is not strong enough, a beam made of angle iron can be used and then fix the unit on it.
- ④ . If the indoor unit is not installed in the air conditioning area, please use sponge around the unit to prevent condensing. The thickness of the sponge depends on the actual installation environment.

3.4 Horizontality Check of the Indoor Unit

After the installation of the indoor unit, its horizontality must be checked to make sure the unit keep horizontal fore and aft and keep an inclination of 5° toward the drain pipe right and left, as shown in Fig.6.

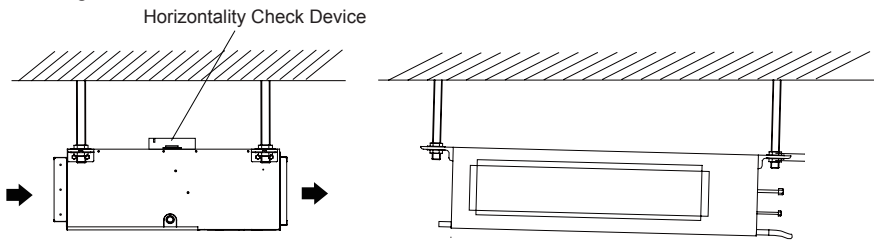

Fig.6

3.5 Installation of the Air Supply Duct

(1). Installation of the Rectangular Air Supply Duct

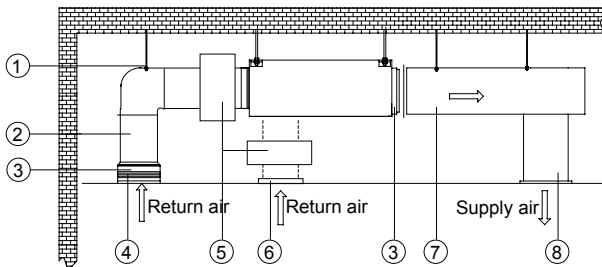

Fig.7

Table 2

No.	Name	No.	Name
1	Hanger	5	Plenum Box
2	Return Air Duct	6	Filter Screen
3	Canvas Duct	7	Main Air Supply Duct
4	Return Air Inlet	8	Air Supply Outlet

(2). Installation of the Round Air Supply Duct

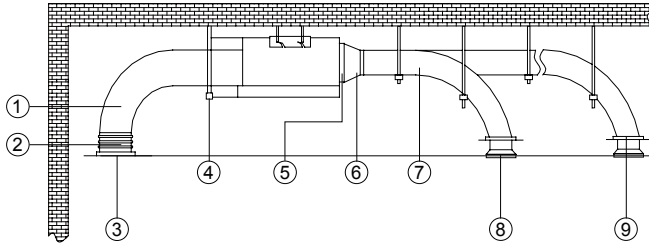

Fig.8

Table 3

No.	Name	No.	Name
1	Return Air Duct	6	Transition Duct
2	Canvas Duct	7	Air Supply Duct
3	Return Air Louver	8	Diffuser
4	Hanger	9	Diffuser Joint
5	Air Supply Outlet		

(3). Installation Steps of the Round Air Supply Duct

- 1). Preinstall the outlet of the round duct on the transition duct and then fix it by the tapping screw.
- 2). Place the transition duct to the air outlet of the unit and fix it with rivet.
- 3). Connect the outlet to the duct and then tighten them with tape. Other installation details are not covered herein.

⚠ CAUTION!

- ① . The maximum length of the duct means the maximum length of the air supply duct plus the maximum length of the return air duct.
- ② . For the unit with the auxiliary electric heating function, if the round duct is to be adopted, then the straight length of the transition duct can not be less than 200mm.
- ③ . The duct is either rectangular or round and connected with the air inlet/outlet of the indoor unit. Among all air supply outlets, at least one should be kept open. As for the round duct, it needs a transition duct of which the size should match with the air supply outlet of the unit. After the fitting of the transition duct, it is the turn of the round duct, which is better to be kept 10 meters far away from the corresponding diffuser. The standard accessories supplied by GREE is the transition duct 200mm long and round air outlet $\phi 200$, however, those of other specifications can be purchased.

3.6 Drawings of the Air Supply Outlet and Return Air Inlet

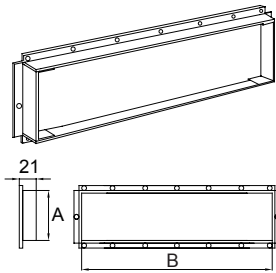

Fig.9 Air Supply Outlet

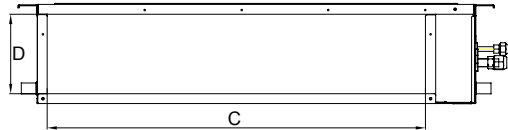

Fig.10 Return Air Inlet

Table 4 Dimensions of the Air Supply Outlet and Return Air Inlet (unit: mm)

Model	Item	Air Supply Outlet		Return Air Inlet	
		A	B	C	D
GFH(09)EA-D3DNA1A/I		156	662	580	162
GFH(12)EA-D3DNA1A/I			862		
GFH(18)EA-D3DNA1A/I		156	1062	780	162
GFH(21)EA-D3DNA1A/I		156	1062	980	162
GFH(24)EA-D3DNA1A/I					

3.7 Installation of the Return Air Duct

- (1). The default installation location of the rectangular flange is in the back and the return air cover plate is in the bottom, as shown in Fig.11.

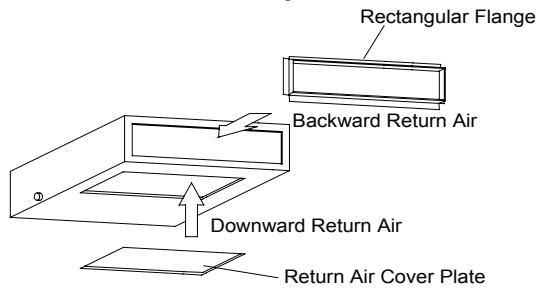

Fig.11

- (2). If the downward return air is desired, just change the place of the rectangular flange and the return air cover plate.
- (3). Connect one end of the return air duct to the return air outlet of the unit by rivets and the other to the return air louver. For the sake of the convenience to freely adjust the height, a cutting of canvas duct will be helpful, which can be reinforced and folded by 8 # iron wire.
- (4). More noise is likely to be produced in the downward return air mode than the backward return air mode, so it is suggestive to install a muffler and a plenum box to minimize the noise.
- (5). The installation method can be chosen with considering the conditions of the building and maintenance etc., as shown in Fig.12.

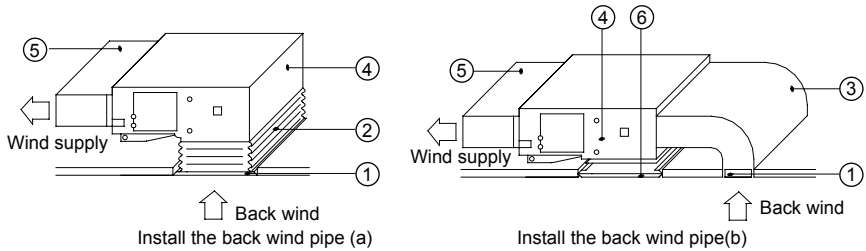

Fig.12

Table 5 Parts and Components of the Return Air Duct

No.	Name	No.	Name
1	Return Air Louver(with the filter screen)	4	Indoor Unit
2	Canvas Duct	5	Air Supply Duct
3	Return Air Duct	6	Access Grille

3.8 Installation of the Condensate Pipe

- (1). The condensate pipe should keep a inclination angle of $5 \sim 10^\circ$, which can facilitate the drainage of the condensate water. And the joints of the condensate pipe should be insulated by the insulation material to prevent condensing(see Fig.13).

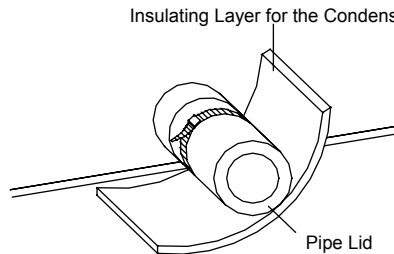

Fig.13 Thermal Insulation of the Condensate Pipe

- (2). There is a condensate outlet on both left and right sides of the unit. Once one is confirmed to be used, the other should be clogged by a rubber plug, bundled by the binding wire and insulated by the insulation material to avoid water leakage.
- (3). The right outlet is defaulted to be clogged with a plug.

⚠ CAUTION! No water leakage is allowed on the joint of the condensate pipe.

3.9 Design of the Drain Pipe

- (1). The drain pipe should always keep an inclination angle($1/50 \sim 1/100$) to avoid the water gathering in some certain place.
- (2). During the connection of the drain pipe and device, do not impose too much force on the pipe on one side of the device and the pipe should be fixed as close as to the device.
- (3). The drain pipe can be the ordinary hard PVC pipe which can be purchased locally. During the connection, inset the end of the PVC pipe to the drain outlet, then tighten it with the drain hose and binding wire but never connect the drain outlet and the drain hose by adhesive.

- (4). When the drain pipe is used for multiple devices, the public section of the pipe should be 100mm lower than the drain hole of each device and it is better to use the much thicker pipe for such a purpose.

3.10 Installation of the Drain Pipe

- (1). The diameter of the drain pipe should be larger than or equal to that of the refrigerant pipe (PVC pipe, outer diameter: 25mm, wall thickness ≥ 1.5 mm).
- (2). The drain pipe should be as short as possible and with at least a 1/100 degree of slope to avoid forming air pockets.
- (3). If the proper degree of slope of the drain pipe is not allowed, a lift pipe should be installed.
- (4). A distance 1-1.5m should be kept between the hangers to avoid the drain hose making a turn.

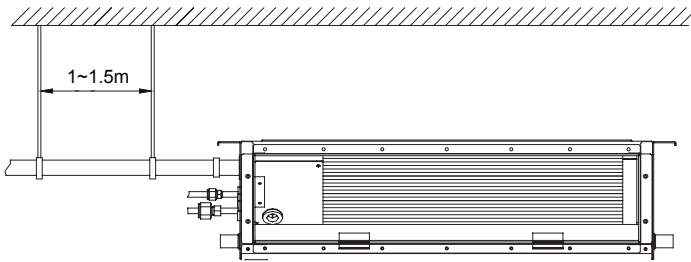

(Right) with a min. degree of slope 1/100

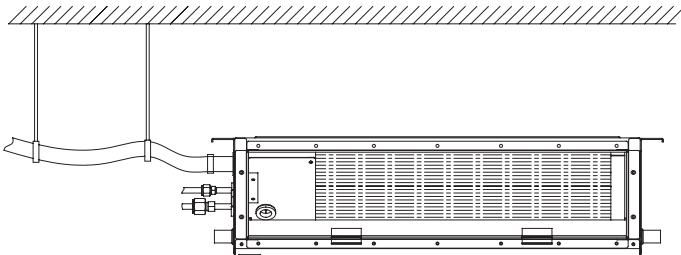

(Wrong)

Fig.14

- (5). Insert the drain hose into the drain hole and tighten it with clamps.
- (6). Wrap the clamps with large amount of sponge for thermal insulation.
- (7). The drain hose inside the room also should be insulated.

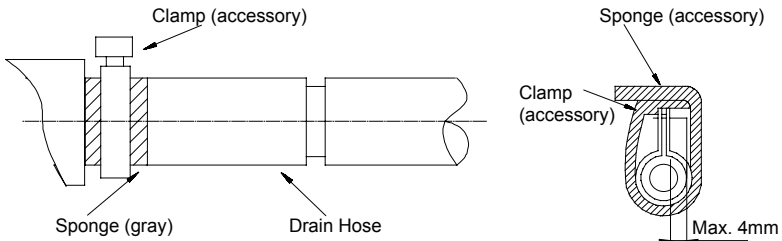

Fig.15

3.11 Precautions for the Lift Pipe

The installation height of the lift pipe should be less than 850mm. It is recommended to set an inclination angle $1^{\circ} \sim 2^{\circ}$ for the lift pipe toward the drainage direction. If the lift pipe and the unit form a right angle, the height of the lift pipe must be less than 800mm.

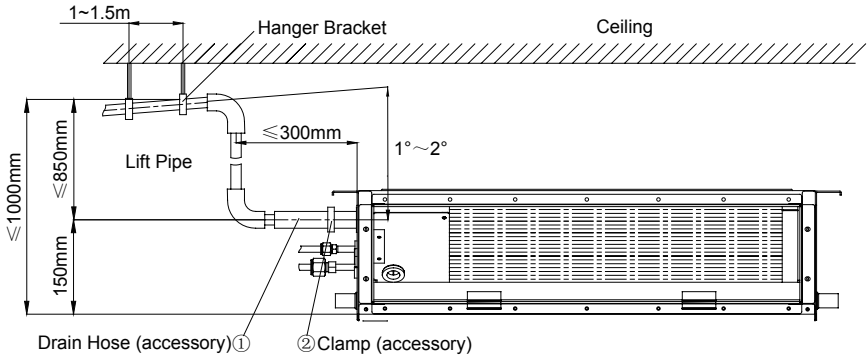

Fig.16

Notes:

- ① . The inclination height of the drain hose should be within 75mm so that the outlet of the drain hose does not suffer the external force.
- ② . If multiple drain pipes converge, please follow the installation steps below.

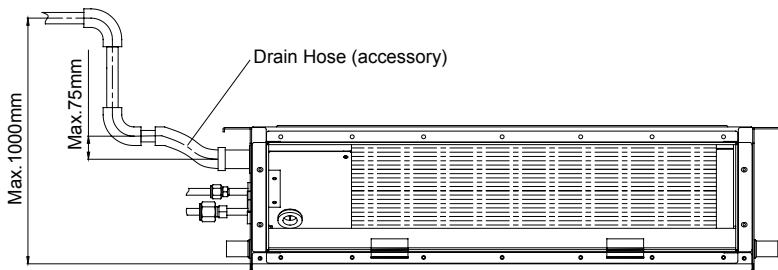
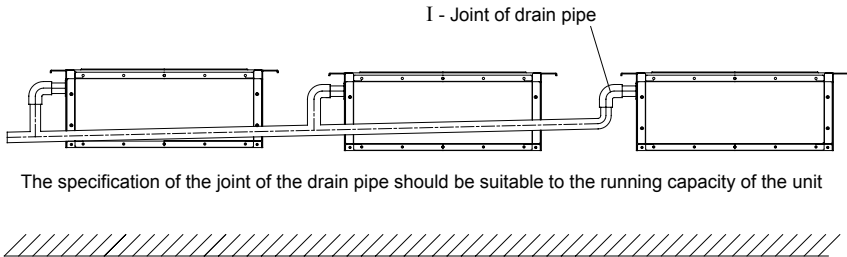

Fig.17

3.12 Test for the Drainage System

- (1). After the electric installation, please take a test for the drainage system.
- (2). During the test, check if the water flow goes through the pipe correctly and observe

carefully the joint to see if it leaks or not. If this unit is installed in the newly built house, it is suggested to take this test prior to the ceiling decoration.

3.13 Piping

- (1). Let the flare end of the copper pipe point at the screw and then tighten the screw by hand.
- (2). After that, tighten the screw by the torque wrench until it clatters (as shown in Fig.18).

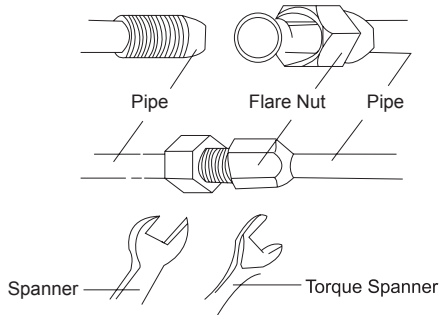

Fig.18

Table 6 Moments of Torque for Tightening Screws

Diameter of Pipe(mm)	Moment of Torque (N·m)
φ6.35	15-30
φ9.52	35-40
φ12	45-50
φ15.9	60-65

- (3). The bending degree of the pipe can not be too small; otherwise it will crack. And please use a pipe tube bender to bend the pipe.
- (4). Wrap the exposed refrigerant pipe and the joints by sponge and then tighten them with the plastic tape.

⚠ CAUTION!

① . During the connection of the indoor unit and the refrigerant pipe, never pull any joints of the indoor unit by force; otherwise the capillary pipe or other pipe may crack, which then would result in leakage.

② . The refrigerant pipe should be supported by brackets, that is, don't let the unit withstand the weight of it.

If the specification of the outdoor unit pipe joint does not conform to that of the indoor unit, then the joint specification of the outlet pipe of the indoor unit takes precedence. A reducing nipple shall be installed at the joint of the outdoor unit so as to make the joint of the outdoor unit compatible with that of the indoor unit.

3.14 Insulation for the Refrigerant Pipe

- (1). The refrigerant pipe should be insulated by the insulating material and plastic tape in order to prevent condensation and water leakage.
- (2). The joints of the indoor unit should be wrapped with the insulating material and no gap is

allowed on the joint of the indoor unit, as shown in Fig.19.

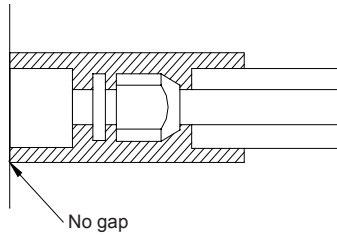

Fig.19

⚠ CAUTION!

After the pipe is protected well enough, never bend it to form a small angle; otherwise it would crack or break.

(3). Wrap the pipe with tape.

- 1). Bundle the refrigerant pipe and electric wire together with tape, and separate them from the drain pipe to prevent the condensate water overflowing.
- 2). Wrap the pipe from the bottom of the outdoor unit to the top of the pipe where it enters the wall. During the wrapping, the later circle should cover half of the former one.
- 3). Fix the wrapped pipe on the wall with clamps.

⚠ CAUTION!

- ① . Do not wrap the pipe too tightly; otherwise the insulation effect would be weakened. Additionally, make sure the drain hose is separated from the pipe.
- ② . After that, fill the hole on the wall with sealing material to prevent wind and rain coming into the room.

3.15 Wiring between the Wire and the Wiring Terminal

(1). Wiring of the Single-Core Wire

- 1). Strip the insulating layer at the end of the wire about 25mm off with a wire stripper.
- 2). Loosen the screw off on the wiring board of the air conditioning unit.
- 3). Shape with the pliers at the end of the wire to a circle matching with the size of the screw.
- 4). Let the screw go through the circle of the wire and then fix it on the wiring board.

(2). Wiring of the Multi-Core Wire

- 1). Strip the insulating layer at the end of the wire about 100mm off with a wire stripper.
- 2). Loosen the screw off on the wiring board of the air conditioning unit.
- 3). Fix a wiring terminal matching with the size of the screw to the end of the multi-core wire with the crimping pliers.
- 4). Let the screw go through the terminal of the multi-core wire and then fix it on the wiring board.

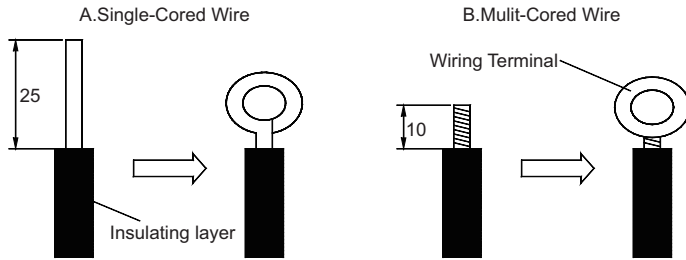

Fig.20

⚠ WARNING!

- ①. If the power cord or the signal line is damaged, they must be replaced with the dedicated one.
- ②. Prior to the wiring, please check the voltage marked on the nameplate and then carry out the wiring following the wiring diagram.
- ③. The dedicated power cord must be used for the air conditioning unit and the electrical leakage protection switch and air switch must be installed in case of the overload condition.
- ④. The air conditioning unit must be earthed to prevent the hazard caused by the failed insulation.
- ⑤. During the wiring, the wiring terminal or the single-core wire must be used; the direct wiring between the multi-core wire and wiring board would cause fire.
- ⑥. All wiring should be done strictly in accordance with the wiring diagram; otherwise the improper wiring would cause the air conditioning unit running abnormally or damaged.
- ⑦. Do not let the electric wires touch the refrigerant pipe, the compressor, the fan or other moving parts.
- ⑧. Do not modify the wiring inside the indoor unit randomly; otherwise the manufacturer won't assume any responsibility for the damage or abnormal running of the unit.

3.16 Wiring of the Power Cord (single-phase)

⚠ CAUTION!

The power supply for each indoor unit must be uniform.

- ①. Dismantle the cover of the electric box of the indoor unit.
- ②. Let the power cord go through the rubber ring.
- ③. Put the 4-core cable through the hole of the chassis and the bottom of the appliance upward, and then connect the power line and the communication line from the outdoor unit to the corresponding terminals N(1), 2, 3, and grounding terminal of the indoor unit. Wiring shall be done properly as per the wiring diagram. (Note: Be sure the wiring terminals A/B/C/D and piping joints A/B/C/D of the indoor unit match with that of the outdoor unit respectively).
- ④. Fix the power cord tightly with the binding wire.

GWHD(36)NK3AO

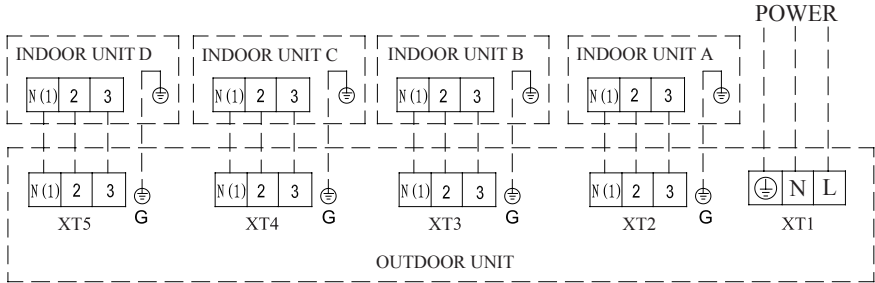

Fig.21

GWHD(42)NK3AO

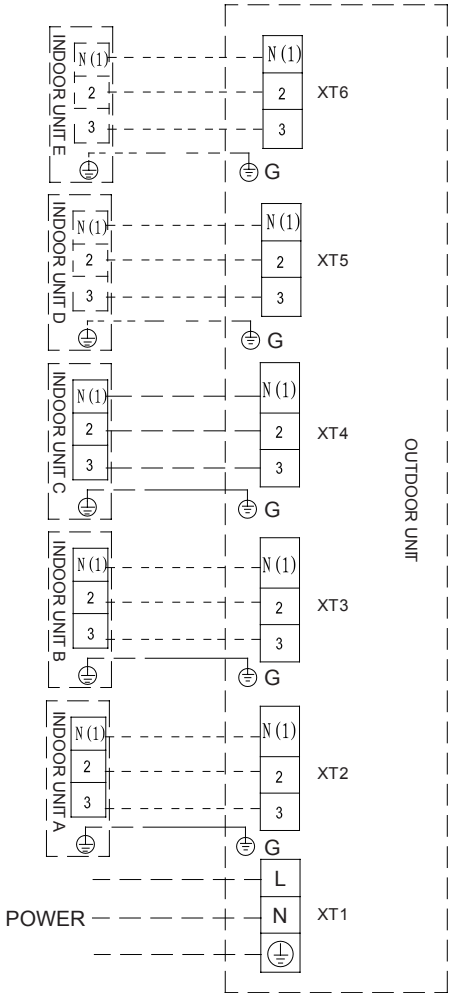

Fig.22

3.17 Wiring of the Signal Line of the Wired Controller

- (1). Open the cover of the electric box of the indoor unit.
- (2). Let the signal line go through the rubber ring.
- (3). Insert the signal line to the four-pin socket on the printed circuit board of the indoor unit.
- (4). Fix the signal line with the binding wire.

3.18 Electric Installation

Table 7

Indoor Unit		Power Supply	Running Current (A)	Input Power(W)		Recommended Power Cord (Sectional Area× Pieces)
Type	Model		Indoor Fan Motor	Cooling	Heating	
Cooling and Heating	GFH(09)EA-D3DNA1A/I	208/230V~ 60Hz	0.406	75	575	AWG18×4
	GFH(12)EA-D3DNA1A/I	208/230V~ 60Hz	0.348	65	865	AWG18×4
	GFH(18)EA-D3DNA1A/I	208/230V~ 60Hz	0.428	80	1080	AWG18×4
	GFH(21)EA-D3DNA1A/I	208/230V~ 60Hz	0.588	110	1610	AWG18×4
	GFH(24)EA-D3DNA1A/I	208/230V~ 60Hz	0.588	110	1610	AWG18×4

Notes:

The sectional area listed above is applicable to the power cord with at most a length of 15 meters. For the longer cord, its sectional area should be enlarged to avoid the cord burning out caused by the over-current.

4 Rated Working Conditions

Table 8 Working Temperature Range

	Indoor side state °F (°C)		Outdoor side state °F (°C)	
	Dry bulb temp. °F (°C)	Wet bulb temp. °F (°C)	Dry bulb temp. °F (°C)	Wet bulb temp. °F (°C)
Rated. Cooling	80.0(26.7)	67.0(19.4)	95.0(35.0)	75.0(23.9)
Max. cooling	80.0(26.7)	67.0(19.4)	115.0(46.1)	75.0(23.9)
Min. cooling	67.0(19.4)	57.0(13.9)	67.0(19.4)	57.0(13.9)
Rated. Heating	70.0(21.1)	60.0(15.6)	47.0(8.3)	43.0(6.1)
Max. heating	80.0(26.7)	—	75.0(23.9)	65.0(18.3)
Low Ambient heating	70.0(21.1)	60.0(15.6)	5.0(-15.0)	3.2(-16.0)

5 Error Analysis

If your conditioning unit runs abnormally, please check the following items before contacting the maintenance serviceman.

Table 9

Errors	Possible Causes
Failed startup	There is no power supply. The breaker opens owing to electrical leakage. Voltage is too low.
Stop after a short while of operation	The air inlet/outlet of the indoor/outdoor unit is clogged.
Poor cooling effect	The air filter screen is too dirty or clogged. There are too much heat sources or people in the room. The door or window is open. There are obstacles at the air inlet/outlet. The set temperature is too high.
Poor heating effect	The air filter screen is too dirty or clogged. The door or window is not closed fully. The set temperature is too low.
Uncontrollable controller	If the remote controller crashes even if the batteries have been replaced, please open the back cover of it and press the button "ACL" to let it back to the normal condition. Is the remoter controller in the signal receiving range? Or is it blocked by obstacles? For the duct type unit, operate the remote controller pointing at the wired controller. Check if the otherwise change new batteries, of the wired controller is enough; or change them.

Note:

If the air conditioner still runs abnormally after the above check and handling, please contact the maintenance serviceman at the local appointed service center.

6 Maintenance

CAUTION!

Take notice of the following items before cleaning your air conditioning unit.

- (1). Cut off the main power supply before contacting any wiring device.
- (2). Only when the unit is turned off and the main power supply is cut off, can the unit be cleaned; otherwise it would cause an electric shock or injury.
- (3). Do not wash the unit with water; or it may cause an electric shock.
- (4). During the cleaning, remember to use the stable standing platform Daily Maintenance.
 - 1). How to clean the filter
 - ① . Never dismantle the air filter except for cleaning; otherwise it may cause some error.
 - ② . When the air conditioning unit is used under the environment with heavy dust, the air filter should be cleaned often (generally once every two weeks).
 - 2). Maintenance before seasonal use
 - ① . Check if the air inlet/outlet of the indoor unit is clogged.
 - ② . Check if the earthing is in good condition.
 - ③ . Check if the wiring is in good condition.
 - ④ . Check if the indicating lamp of the wired controller blinks after it is energized.

Note: If there is something abnormal, please consult the after-sales serviceman.

- 3). Maintenance after seasonal use
 - ① . Let the air conditioning unit run for half day under the fan mode to dry the inside of the unit.
 - ② . If the unit is not to be used for a long time, please shut off the main power supply for energy conservation, at the same time, the power indicating lamp of the wired control will go off.

GREE ELECTRIC APPLIANCES, INC. OF ZHUHAI

Add: West Jinji Rd, Qianshan, Zhuhai, Guangdong, China, 519070

Tel: (+86-756) 8522218 Fax: (+86-756) 8669426

E-mail: gree@gree.com.cn www.gree.com



66175200003